

Miniature Basic Switch

D3V

Reliable Basic Switch with External Lever

- Available by 0.1 A, 6 A, 11 A, 16 A and 21 A models, all with self-cleaning contacts. 0.1 A utilizes gold alloy crossbar contacts for high reliability at low loads.
- Available with internally or externally fitted levers, and 2 fixing positions for external levers.
- Conforms to EN61058-1 UL1054.
- Right-angle plunger option available in some models.
- RoHS Compliant.



Ordering Information

■ Model Number Legend

D3V-□□□□-□□□□-□□-□□

1 2 3 4 5 6 7 8 9

1. Ratings

- 21: 20 (4) A at 250 VAC
- 16: 16 (3) A at 250 VAC
- 11: 11 (3) A at 250 VAC
- 6: 6 (2) A at 250 VAC
- 01: 0.1 A at 125 VAC

2. Contact Gap

- None: 1 mm (F gap)
- G: 0.5 mm (G gap)

3. Actuator

- None: Pin plunger
- 1: Short hinge lever
- 2: Hinge lever
- 3: Long hinge lever
- 4: Simulated roller lever
- 5: Short hinge roller lever
- 6: Hinge roller lever

4. Hinge Position

- None: Internal/Far from plunger
- M: External/Far from plunger
- K: External/Near plunger

5. Contact Form

- 1: SPDT
- 2: SPST-NC
- 3: SPST-NO

6. Terminals

- A: Solder/quick-connect terminal (#187)
- C2: Quick-connect terminal (#187)
- C: Quick-connect terminal (#250)
(optional without surge creepage tab flush around terminals.)

7. Maximum Operating Force

- 5: 1.96 N {200 gf}
- 4A: 1.23 N {125 gf}
- 4: 0.98 N {100 gf}
- 3: 0.49 N {50 gf}
- 2: 0.25 N {25 gf}

Note: These values are for the plunger models.

8. Mounting Hole Size

- None: 3.1 mm
- K: 2.9 mm

9. Special Code

- None: Standard
- H: High temperature (125°C)
- E: Special rating: 21 (8) A
- T: High temperature (200°C)







Available Combinations

Heat resistance	Model	D3V-21		D3V-16				D3V-11					D3V-6				D3V-01			
		Rated current		21 A		16 A				11 A					6 A				0.1 A	
		OF	1.23 N {125 gf}		1.96 N {200 gf}		0.98 N {100 gf}		1.96 N {200 gf}		0.98 N {100 gf}		0.49 N {50 gf}	1.96 N {200 gf}		0.98 N {100 gf}		0.49 N {50 gf}	0.49 N {50 gf}	0.25 N {25 gf}
			Terminal	G 0.5 mm		F 1 mm		G 0.5 mm		F/G 1 mm or 0.5 mm		F 1 mm	G 0.5 mm	G 0.5 mm	F/G 1 mm or 0.5 mm		F 1 mm	G 0.5 mm	G 0.5 mm	F 1 mm
Standard (85°C)	#187																	●	●	
	#250	●																○	○	
Standard (105°C)	#187		●	○	○	●	○	●	○	○	○	○	○	●	○	●				
	#250		●	○	○	●	○	●	○	○	○	○	○	●	○	●				
High temperature (125°C)	#187		○	○	○	○	○	○	○	○	○	○	○	○	○	○				
	#250		○	○	○	○	○	○	○	○	○	○	○	○	○	○				
High temperature (200°C)	#187												○	○	○	○	○	○	○	
	#250												○	○	○	○	○	○	○	







- Note: 1.** ●: Standard
○: Semi-standard
- 2.** Consult OMRON for specific models with standard approval.

■ List of Models

21 A (OF: 1.23 N {125 gf})

Actuator	Hinge position (far from plunger)	Contact form		
		SPDT	SPST-NC	SPST-NO
Plunger 	---	D3V-21G-1□4A-Δ	D3V-21G-2□4A-Δ	D3V-21G-3□4A-Δ
Short hinge lever 	Internal	D3V-21G1-1□4A-Δ	D3V-21G1-2□4A-Δ	D3V-21G1-3□4A-Δ
	External (M)	D3V-21G1M-1□4A-Δ	D3V-21G1M-2□4A-Δ	D3V-21G1M-3□4A-Δ
Hinge lever 	Internal	D3V-21G2-1□4A-Δ	D3V-21G2-2□4A-Δ	D3V-21G2-3□4A-Δ
	External (M)	D3V-21G2M-1□4A-Δ	D3V-21G2M-2□4A-Δ	D3V-21G2M-3□4A-Δ
Long hinge lever 	Internal	D3V-21G3-1□4A-Δ	D3V-21G3-2□4A-Δ	D3V-21G3-3□4A-Δ
	External (M)	D3V-21G3M-1□4A-Δ	D3V-21G3M-2□4A-Δ	D3V-21G3M-3□4A-Δ
Simulated roller lever 	Internal	D3V-21G4-1□4A-Δ	D3V-21G4-2□4A-Δ	D3V-21G4-3□4A-Δ
	External (M)	D3V-21G4M-1□4A-Δ	D3V-21G4M-2□4A-Δ	D3V-21G4M-3□4A-Δ
Short hinge roller lever 	Internal	D3V-21G5-1□4A-Δ	D3V-21G5-2□4A-Δ	D3V-21G5-3□4A-Δ
	External (M)	D3V-21G5M-1□4A-Δ	D3V-21G5M-2□4A-Δ	D3V-21G5M-3□4A-Δ
Hinge roller lever 	Internal	D3V-21G6-1□4A-Δ	D3V-21G6-2□4A-Δ	D3V-21G6-3□4A-Δ
	External (M)	D3V-21G6M-1□4A-Δ	D3V-21G6M-2□4A-Δ	D3V-21G6M-3□4A-Δ

16 A (OF: 1.96 N {200 gf})

Actuator	Hinge position (far from plunger)	Contact form		
		SPDT	SPST-NC	SPST-NO
Plunger 	---	D3V-16-1□5-Δ	D3V-16-2□5-Δ	D3V-16-3□5-Δ
Short hinge lever 	Internal	D3V-161-1□5-Δ	D3V-161-2□5-Δ	D3V-161-3□5-Δ
	External (M)	D3V-161M-1□5-Δ	D3V-161M-2□5-Δ	D3V-161M-3□5-Δ
Hinge lever 	Internal	D3V-162-1□5-Δ	D3V-162-2□5-Δ	D3V-162-3□5-Δ
	External (M)	D3V-162M-1□5-Δ	D3V-162M-2□5-Δ	D3V-162M-3□5-Δ
Long hinge lever 	Internal	D3V-163-1□5-Δ	D3V-163-2□5-Δ	D3V-163-3□5-Δ
	External (M)	D3V-163M-1□5-Δ	D3V-163M-2□5-Δ	D3V-163M-3□5-Δ
Simulated roller lever 	Internal	D3V-164-1□5-Δ	D3V-164-2□5-Δ	D3V-164-3□5-Δ
	External (M)	D3V-164M-1□5-Δ	D3V-164M-2□5-Δ	D3V-164M-3□5-Δ
Short hinge roller lever 	Internal	D3V-165-1□5-Δ	D3V-165-2□5-Δ	D3V-165-3□5-Δ
	External (M)	D3V-165M-1□5-Δ	D3V-165M-2□5-Δ	D3V-165M-3□5-Δ
Hinge roller lever 	Internal	D3V-166-1□5-Δ	D3V-166-2□5-Δ	D3V-166-3□5-Δ
	External (M)	D3V-166M-1□5-Δ	D3V-166M-2□5-Δ	D3V-166M-3□5-Δ

Note: The □ in the model number is for the terminal code.

A: Solder/quick-connect terminals (#187)

C2: Quick-connect terminals (#187)







C: Quick-connect terminals (#250)

The Δ in the model number is for the mounting hole size.







None: 3.1 mm

K: 2.9 mm

16 A (OF: 0.98 N {100 gf})







Actuator	Hinge position (far from plunger)	Contact form		
		SPDT	SPST-NC	SPST-NO
Plunger 	---	D3V-16-1□4-Δ	D3V-16-2□4-Δ	D3V-16-3□4-Δ
Short hinge lever 	Internal	D3V-161-1□4-Δ	D3V-161-2□4-Δ	D3V-161-3□4-Δ
	External (M)	D3V-161M-1□4-Δ	D3V-161M-2□4-Δ	D3V-161M-3□4-Δ
Hinge lever 	Internal	D3V-162-1□4-Δ	D3V-162-2□4-Δ	D3V-162-3□4-Δ
	External (M)	D3V-162M-1□4-Δ	D3V-162M-2□4-Δ	D3V-162M-3□4-Δ
Long hinge lever 	Internal	D3V-163-1□4-Δ	D3V-163-2□4-Δ	D3V-163-3□4-Δ
	External (M)	D3V-163M-1□4-Δ	D3V-163M-2□4-Δ	D3V-163M-3□4-Δ
Simulated roller lever 	Internal	D3V-164-1□4-Δ	D3V-164-2□4-Δ	D3V-164-3□4-Δ
	External (M)	D3V-164M-1□4-Δ	D3V-164M-2□4-Δ	D3V-164M-3□4-Δ
Short hinge roller lever 	Internal	D3V-165-1□4-Δ	D3V-165-2□4-Δ	D3V-165-3□4-Δ
	External (M)	D3V-165M-1□4-Δ	D3V-165M-2□4-Δ	D3V-165M-3□4-Δ
Hinge roller lever 	Internal	D3V-166-1□4-Δ	D3V-166-2□4-Δ	D3V-166-3□4-Δ
	External (M)	D3V-166M-1□4-Δ	D3V-166M-2□4-Δ	D3V-166M-3□4-Δ

11 A (OF: 1.96 N {200 gf})







Actuator	Hinge position (far from plunger)	Contact form		
		SPDT	SPST-NC	SPST-NO
Plunger 	---	D3V-11-1□5-Δ	D3V-11-2□5-Δ	D3V-11-3□5-Δ
Short hinge lever 	Internal	D3V-111-1□5-Δ	D3V-111-2□5-Δ	D3V-111-3□5-Δ
	External (M)	D3V-111M-1□5-Δ	D3V-111M-2□5-Δ	D3V-111M-3□5-Δ
Hinge lever 	Internal	D3V-112-1□5-Δ	D3V-112-2□5-Δ	D3V-112-3□5-Δ
	External (M)	D3V-112M-1□5-Δ	D3V-112M-2□5-Δ	D3V-112M-3□5-Δ
Long hinge lever 	Internal	D3V-113-1□5-Δ	D3V-113-2□5-Δ	D3V-113-3□5-Δ
	External (M)	D3V-113M-1□5-Δ	D3V-113M-2□5-Δ	D3V-113M-3□5-Δ
Simulated roller lever 	Internal	D3V-114-1□5-Δ	D3V-114-2□5-Δ	D3V-114-3□5-Δ
	External (M)	D3V-114M-1□5-Δ	D3V-114M-2□5-Δ	D3V-114M-3□5-Δ
Short hinge roller lever 	Internal	D3V-115-1□5-Δ	D3V-115-2□5-Δ	D3V-115-3□5-Δ
	External (M)	D3V-115M-1□5-Δ	D3V-115M-2□5-Δ	D3V-115M-3□5-Δ
Hinge roller lever 	Internal	D3V-116-1□5-Δ	D3V-116-2□5-Δ	D3V-116-3□5-Δ
	External (M)	D3V-116M-1□5-Δ	D3V-116M-2□5-Δ	D3V-116M-3□5-Δ

Note: The □ in the model number is for the terminal code.
 A: Solder/quick-connect terminals (#187)
 C2: Quick-connect terminals (#187)
 C: Quick-connect terminals (#250)
 The Δ in the model number is for the mounting hole size.
 None: 3.1 mm
 K: 2.9 mm

11 A (OF: 0.98 N {100 gf})

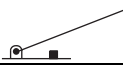





Actuator	Hinge position (far from plunger)	Contact form		
		SPDT	SPST-NC	SPST-NO
Plunger 	---	D3V-11-1□4-Δ	D3V-11-2□4-Δ	D3V-11-3□4-Δ
Short hinge lever 	Internal	D3V-111-1□4-Δ	D3V-111-2□4-Δ	D3V-111-3□4-Δ
	External (M)	D3V-111M-1□4-Δ	D3V-111M-2□4-Δ	D3V-111M-3□4-Δ
Hinge lever 	Internal	D3V-112-1□4-Δ	D3V-112-2□4-Δ	D3V-112-3□4-Δ
	External (M)	D3V-112M-1□4-Δ	D3V-112M-2□4-Δ	D3V-112M-3□4-Δ
Long hinge lever 	Internal	D3V-113-1□4-Δ	D3V-113-2□4-Δ	D3V-113-3□4-Δ
	External (M)	D3V-113M-1□4-Δ	D3V-113M-2□4-Δ	D3V-113M-3□4-Δ
Simulated roller lever 	Internal	D3V-114-1□4-Δ	D3V-114-2□4-Δ	D3V-114-3□4-Δ
	External (M)	D3V-114M-1□4-Δ	D3V-114M-2□4-Δ	D3V-114M-3□4-Δ
Short hinge roller lever 	Internal	D3V-115-1□4-Δ	D3V-115-2□4-Δ	D3V-115-3□4-Δ
	External (M)	D3V-115M-1□4-Δ	D3V-115M-2□4-Δ	D3V-115M-3□4-Δ
Hinge roller lever 	Internal	D3V-116-1□4-Δ	D3V-116-2□4-Δ	D3V-116-3□4-Δ
	External (M)	D3V-116M-1□4-Δ	D3V-116M-2□4-Δ	D3V-116M-3□4-Δ

11 A (OF: 0.49 N {50 gf})







Actuator	Hinge position (far from plunger)	Contact form		
		SPDT	SPST-NC	SPST-NO
Plunger 	---	D3V-11G-1□3-Δ	D3V-11G-2□4-Δ	D3V-11G-3□3-Δ
Short hinge lever 	Internal	D3V-11G1-1□3-Δ	D3V-11G1-2□4-Δ	D3V-11G1-3□3-Δ
	External (M)	D3V-11G1M-1□3-Δ	D3V-11G1M-2□3-Δ	D3V-11G1M-3□3-Δ
Hinge lever 	Internal	D3V-11G2-1□3-Δ	D3V-11G2-2□3-Δ	D3V-11G2-3□3-Δ
	External (M)	D3V-11G2M-1□3-Δ	D3V-11G2M-2□3-Δ	D3V-11G2M-3□3-Δ
Long hinge lever 	Internal	D3V-11G3-1□3-Δ	D3V-11G3-2□3-Δ	D3V-11G3-3□3-Δ
	External (M)	D3V-11G3M-1□3-Δ	D3V-11G3M-2□3-Δ	D3V-11G3M-3□3-Δ
Simulated roller lever 	Internal	D3V-11G4-1□3-Δ	D3V-11G4-2□3-Δ	D3V-11G4-3□3-Δ
	External (M)	D3V-11G4M-1□3-Δ	D3V-11G4M-2□3-Δ	D3V-11G4M-3□3-Δ
Short hinge roller lever 	Internal	D3V-11G5-1□3-Δ	D3V-11G5-2□3-Δ	D3V-11G5-3□3-Δ
	External (M)	D3V-11G5M-1□3-Δ	D3V-11G5M-2□3-Δ	D3V-11G5M-3□3-Δ
Hinge roller lever 	Internal	D3V-11G6-1□3-Δ	D3V-11G6-2□3-Δ	D3V-11G6-3□3-Δ
	External (M)	D3V-11G6M-1□3-Δ	D3V-11G6M-2□3-Δ	D3V-11G6M-3□3-Δ

Note: The □ in the model number is for the terminal code.
A: Solder/quick-connect terminals (#187)
C2: Quick-connect terminals (#187)
C: Quick-connect terminals (#250)
The Δ in the model number is for the mounting hole size.
None: 3.1 mm
K: 2.9 mm

6 A (OF: 0.98 N {100 gf})







Actuator	Hinge position (far from plunger)	Contact form		
		SPDT	SPST-NC	SPST-NO
Plunger 	---	D3V-6-1□4-Δ	D3V-6-2□4-Δ	D3V-6-3□4-Δ
Short hinge lever 	Internal	D3V-61-1□4-Δ	D3V-61-2□4-Δ	D3V-61-3□4-Δ
	External (M)	D3V-61M-1□4-Δ	D3V-61M-2□4-Δ	D3V-61M-3□4-Δ
Hinge lever 	Internal	D3V-62-1□4-Δ	D3V-62-2□4-Δ	D3V-62-3□4-Δ
	External (M)	D3V-62M-1□4-Δ	D3V-62M-2□4-Δ	D3V-62M-3□4-Δ
Long hinge lever 	Internal	D3V-63-1□4-Δ	D3V-63-2□4-Δ	D3V-63-3□4-Δ
	External (M)	D3V-63M-1□4-Δ	D3V-63M-2□4-Δ	D3V-63M-3□4-Δ
Simulated roller lever 	Internal	D3V-64-1□4-Δ	D3V-64-2□4-Δ	D3V-64-3□4-Δ
	External (M)	D3V-64M-1□4-Δ	D3V-64M-2□4-Δ	D3V-64M-3□4-Δ
Short hinge roller lever 	Internal	D3V-65-1□4-Δ	D3V-65-2□4-Δ	D3V-65-3□4-Δ
	External (M)	D3V-65M-1□4-Δ	D3V-65M-2□4-Δ	D3V-65M-3□4-Δ
Hinge roller lever 	Internal	D3V-66-1□4-Δ	D3V-66-2□4-Δ	D3V-66-3□4-Δ
	External (M)	D3V-66M-1□4-Δ	D3V-66M-2□4-Δ	D3V-66M-3□4-Δ

6 A (OF: 0.49 N {50 gf})

Actuator	Hinge position (far from plunger)	Contact form		
		SPDT	SPST-NC	SPST-NO
Plunger 	---	D3V-6G-1□3-Δ	D3V-6G-2□3-Δ	D3V-6G-3□3-Δ
Short hinge lever 	Internal	D3V-6G1-1□3-Δ	D3V-6G1-2□3-Δ	D3V-6G1-3□3-Δ
	External (M)	D3V-6G1M-1□3-Δ	D3V-6G1M-2□3-Δ	D3V-6G1M-3□3-Δ
Hinge lever 	Internal	D3V-6G2-1□3-Δ	D3V-6G2-2□3-Δ	D3V-6G2-3□3-Δ
	External (M)	D3V-6G2M-1□3-Δ	D3V-6G2M-2□3-Δ	D3V-6G2M-3□3-Δ
Long hinge lever 	Internal	D3V-6G3-1□3-Δ	D3V-6G3-2□3-Δ	D3V-6G3-3□3-Δ
	External (M)	D3V-6G3M-1□3-Δ	D3V-6G3M-2□3-Δ	D3V-6G3M-3□3-Δ
Simulated roller lever 	Internal	D3V-6G4-1□3-Δ	D3V-6G4-2□3-Δ	D3V-6G4-3□3-Δ
	External (M)	D3V-6G4M-1□3-Δ	D3V-6G4M-2□3-Δ	D3V-6G4M-3□3-Δ
Short hinge roller lever 	Internal	D3V-6G5-1□3-Δ	D3V-6G5-2□3-Δ	D3V-6G5-3□3-Δ
	External (M)	D3V-6G5M-1□3-Δ	D3V-6G5M-2□3-Δ	D3V-6G5M-3□3-Δ
Hinge roller lever 	Internal	D3V-6G6-1□3-Δ	D3V-6G6-2□3-Δ	D3V-6G6-3□3-Δ
	External (M)	D3V-6G6M-1□3-Δ	D3V-6G6M-2□3-Δ	D3V-6G6M-3□3-Δ

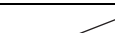
Note: The □ in the model number is for the terminal code.
 A: Solder/quick-connect terminals (#187)
 C2: Quick-connect terminals (#187)
 C: Quick-connect terminals (#250)
 The Δ in the model number is for the mounting hole size.
 None: 3.1 mm
 K: 2.9 mm

01 A (OF: 0.49 N {50 gf})

Actuator	Hinge position (far from plunger)	Contact form		
		SPDT	SPST-NC	SPST-NO
Plunger 	---	D3V-01-1□3-Δ	D3V-01-2□3-Δ	D3V-01-3□3-Δ
Short hinge lever 	Internal	D3V-011-1□3-Δ	D3V-011-2□3-Δ	D3V-011-3□3-Δ
	External (M)	D3V-011M-1□3-Δ	D3V-011M-2□3-Δ	D3V-011M-3□3-Δ
Hinge lever 	Internal	D3V-012-1□3-Δ	D3V-012-2□3-Δ	D3V-012-3□3-Δ
	External (M)	D3V-012M-1□3-Δ	D3V-012M-2□3-Δ	D3V-012M-3□3-Δ
Long hinge lever 	Internal	D3V-013-1□3-Δ	D3V-013-2□3-Δ	D3V-013-3□3-Δ
	External (M)	D3V-013M-1□3-Δ	D3V-013M-2□3-Δ	D3V-013M-3□3-Δ
Simulated roller lever 	Internal	D3V-014-1□3-Δ	D3V-014-2□3-Δ	D3V-014-3□3-Δ
	External (M)	D3V-014M-1□3-Δ	D3V-014M-2□3-Δ	D3V-014M-3□3-Δ
Short hinge roller lever 	Internal	D3V-015-1□3-Δ	D3V-015-2□3-Δ	D3V-015-3□3-Δ
	External (M)	D3V-015M-1□3-Δ	D3V-015M-2□3-Δ	D3V-015M-3□3-Δ
Hinge roller lever 	Internal	D3V-016-1□3-Δ	D3V-016-2□3-Δ	D3V-016-3□3-Δ
	External (M)	D3V-016M-1□3-Δ	D3V-016M-2□3-Δ	D3V-016M-3□3-Δ

01 A (OF: 0.25 N {25 gf})

Actuator	Hinge position (far from plunger)	Contact form		
		SPDT	SPST-NC	SPST-NO
Plunger 	---	D3V-01-1□2-Δ	D3V-01-2□2-Δ	D3V-01-3□2-Δ

Note: The □ in the model number is for the terminal code.
 A: Solder/quick-connect terminals (#187)
 C2: Quick-connect terminals (#187)
 C: Quick-connect terminals (#250)
 The Δ in the model number is for the mounting hole size.
 None: 3.1 mm
 K: 2.9 mm

Specifications

■ Ratings

Type	Rated voltage	Non-inductive load				Inductive load			
		Resistive load		Lamp load		Inductive load		Motor load	
		NC	NO	NC	NO	NC	NO	NC	NO
D3V-21	250 VAC	21 A		3 A		12 A		4 A	
	8 VDC	21 A		5 A		12 A		7 A	
	30 VDC	14 A		5 A		12 A		5 A	
	125 VDC	0.6 A		0.1 A		0.6 A		0.1 A	
	250 VDC	0.3 A		0.05 A		0.3 A		0.05 A	
D3V-16	250 VAC	16 A		2 A		10 A		3 A	
	8 VDC	16 A		4 A		10 A		6 A	
	30 VDC	10 A		4 A		10 A		4 A	
	125 VDC	0.6 A		0.1 A		0.6 A		0.1 A	
	250 VDC	0.3 A		0.05 A		0.3 A		0.05 A	
D3V-11	250 VAC	11 A		1.5 A		6 A		2 A	
	8 VDC	11 A		3 A		6 A		3 A	
	30 VDC	6 A		3 A		6 A		3 A	
	125 VDC	0.6 A		0.1 A		0.6 A		0.1 A	
	250 VDC	0.3 A		0.05 A		0.3 A		0.05 A	
D3V-6	250 VAC	6 A		3 A		4 A		---	
	8 VDC	6 A		3 A		4 A		---	
	30 VDC	6 A		3 A		4 A		---	
	125 VDC	0.4 A		0.1 A		0.4 A		---	
	250 VDC	0.3 A		0.05 A		0.2 A		---	
D3V-01	125 VAC	0.1 A		---		---		---	
	8 VDC	0.1 A		---		---		---	
	30 VDC	0.1 A		---		---		---	

Note: 1. The above current values are the normal current values of models with a contact gap of 1 mm (gap F), which vary with the normal current values of models with a contact gap of 0.5 mm (gap G).

2. Inductive load has a power factor of 0.4 min. (AC) and a time constant of 7 ms max. (DC).

3. Lamp load has an inrush current of 10 times the steady-state current.

4. Motor load has an inrush current of 6 times the steady-state current.

5. The ratings values apply under the following test conditions:

Ambient temperature: 20±2°C

Ambient humidity: 65±5%

Operating frequency: 30 operations/min

■ Characteristics

Operating speed	0.1 mm to 1 m/s (plunger models without levers)
Operating frequency	Mechanical: 600 operations/min Electrical: 60 operations/min
Insulation resistance	100 MΩ min. (at 500 VDC)
Contact resistance (initial values)	D3V-21: 50 mΩ max. D3V-16, D3V-11, D3V-6: 30 mΩ max. D3V-01, 0.49 N {50 gf}: 50 mΩ max. 0.25 N {25 gf}: 100 mΩ max.
Dielectric strength (see note 1)	1,000 VAC, 50/60 Hz for 1 min between terminals of the same polarity 2,000 VAC, 50/60 Hz for 1 min between current-carrying metal parts and ground, and between each terminal and non-current-carrying metal parts
Vibration resistance (see note 2)	Malfunction: 10 to 55 Hz, 1.5-mm double amplitude
Shock resistance (see note 2)	Destruction: 400 m/s ² {approx. 40G} max. Malfunction: 100 m/s ² {approx. 10G} max.
Durability (see note 3)	Mechanical: 10,000,000 operations min. Electrical: D3V-21: 50,000 operations min. D3V-16: 100,000 operations min. D3V-11: 200,000 operations min. D3V-6, D3V-01: 500,000 operations min.
Degree of protection	IEC IP00
Degree of protection against electric shock	Class I
Proof tracking index (PTI)	250
Ambient operating temperature	D3V-21, D3V-01: -25°C to 85°C (with no icing) D3V-16, D3V-11, D3V-6: -25°C to 105°C (with no icing)
Ambient operating humidity	85% max. (for 5°C to 35°C)
Weight	Approx. 6.2 g (plunger models without levers)

- Note:** 1. The dielectric strength values shown in the table are for models with a Separator.
2. For plunger models, the above values apply for use at both the free position and total travel position. For lever models, they apply at the total travel position.
3. For testing conditions, contact your OMRON sales representative.

■ Approved Standards

UL1054 (File No. E41515) CSA C22.2 No.55 (File No. LR21642) **(Only standard ratings are listed.)**

Rated voltage	D3V-21G	D3V-16	D3V-16G	D3V-11	D3V-11G	D3V-6	D3V-6G	D3V-01
125 VAC	21 A, 1/2 HP (See note.)	16 A, 1/2 HP	16 A, 1/2 HP	11 A, 1/2 HP	11 A, 1/2 HP	6 A, 1/4 HP	6 A, 1/4 HP	0.1 A
250 VAC	21 A, 1/2 HP (See note.)	16 A, 1/2 HP	16 A, 1/2 HP	11 A, 1/2 HP	11 A, 1/2 HP	6 A, 1/4 HP	6 A, 1/4 HP	---
125 VDC	---	0.6 A	0.1 A	0.6 A	0.1 A	---	---	---
250 VDC	---	0.3 A	---	0.3 A	---	---	---	---

Note: Approval projected.

EN 61058-1: 1992+A1: 1993 (License No. 119151L)

Rated voltage	D3V-21G	D3V-16	D3V-11	D3V-6	D3V-01
125 VAC	---	---	---	---	0.1 A
250 VAC	20 (4) A	16 (3) A	11 (3) A	6 (2) A	---

Testing conditions: 50,000 operations, T85 (0°C to 85°C) for D3V-21/D3V-01, T105 (0°C to 105°C) for D3V-16/D3V-11/D3V-6

Rated voltage	D3V-21G
250 VAC	21 (8) A

Testing conditions: 10,000 operations, T85 (0°C to 85°C)

Contact Specifications

Item		D3V-21	D3V-16	D3V-11	D3V-6	D3V-01
Contact	Specification	Rivet				Crossbar
	Material	Silver alloy				Gold alloy
	Gap (standard value)	0.5 mm	1 mm (F gap type) or 0.5 mm (G gap type)			1.0 mm
Inrush current	NC	50 A max.	40 A max.	24 A max.	15 A max.	---
	NO					
Minimum applicable load		160 mA at 5 VDC				1 mA at 5 VDC

Contact Form

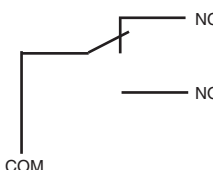
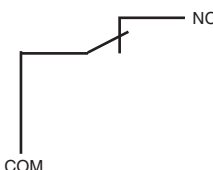
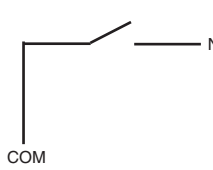
SPDT	SPST-NC	SPST-NO
		

Dimensions

Unit: mm (inch)

Terminals

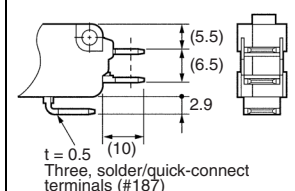
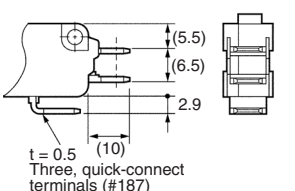
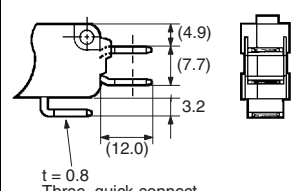
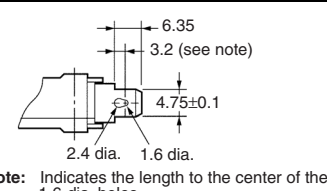
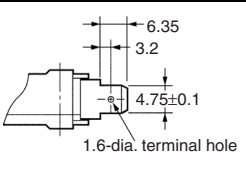
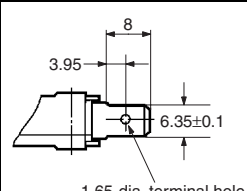
Terminal type	Solder/Quick-connect Terminal (#187) (A)	Quick-connect Terminal (#187) (C2)	Quick-connect Terminal (#250) (C)
COM			
Terminal dimensions			

Note: The table above is for the SPDT contact specifications. Two terminals will be available for SPST-NO or SPST-NC contact specifications. For terminal positions, refer to the above *Contact Form*.

Mounting Holes

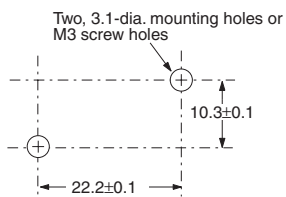

■ Dimensions and Operating Characteristics

- Note:** 1. All units are in millimeters unless otherwise indicated.
 2. Unless otherwise specified, a tolerance of ± 0.4 mm applies to all dimensions.
 3. The following illustrations and drawings are for quick-connect terminals (#187) (terminals C2). D3V models incorporate terminals A and C. These models are different from #187 models in terminal size only. Terminals A and C are omitted from the following drawings. Refer to *Terminals* on page 995 for these terminals.
 4. The following illustrations and drawings are for models with the hinge position set to external/further than plunger. Models with the hinge position set to internal position are not shown here. For details about the internal position models, contact your OMRON sales representative. Operating characteristics are the same for these two types of models.
 5. The □ in the model number is for the terminal code.
 6. The Δ in the model number is for the mounting hole size.
 The hole size in the following illustrations of models with a suffix “K” in the Δ is 2.9 mm.
 7. The operating characteristics are for operation in the A direction (↓).

Plunger Models

- D3V-21G-1□4-Δ
- D3V-16-1□5-Δ
- D3V-11-1□5-Δ
- D3V-11-1□4-Δ
- D3V-6-1□4-Δ
- D3V-6G-1□3-Δ
- D3V-01-1□2-Δ
- D3V-01-1□3-Δ

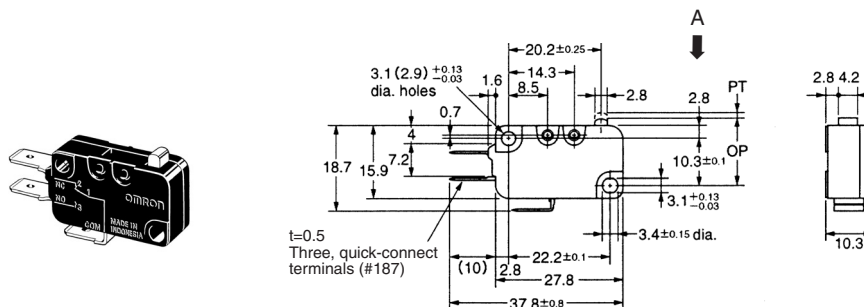

Model	D3V-21G-1□4A-Δ	D3V-16-1□5-Δ D3V-11-1□5-Δ	D3V-11-1□4-Δ D3V-6-1□4-Δ	D3V-6G-1□3-Δ	D3V-01-1□3-Δ	D3V-01-1□2-Δ
OF max.	125 g {1.23 N}	200 g {1.96 N}	100 g {0.98 N}	50 g {0.49 N}	50 g {0.49 N}	25 g {0.25 N}
RF min.	20 g {0.20 N}	50 g {0.49 N}	15 g {0.15 N}	5 g {0.05 N}	5 g {0.05 N}	3 g {0.03 N}
PT max.	1.2 mm	1.2 mm			1.2 mm	
OT min.	1.0 mm	1.0 mm			1.0 mm	
MD max.	0.3 mm	0.4 mm (F gap type) or 0.3 mm (G gap type)			0.4 mm	
OP	14.7±0.4 mm					

Short Hinge Lever Models

- D3V-21GM-1□4A-Δ
- D3V-161M-1□5-Δ
- D3V-111M-1□5-Δ
- D3V-111M-1□4-Δ
- D3V-61M-1□4-Δ
- D3V-6G1M-1□3-Δ
- D3V-01M1-1□2-Δ
- D3V-01M1-1□3-Δ

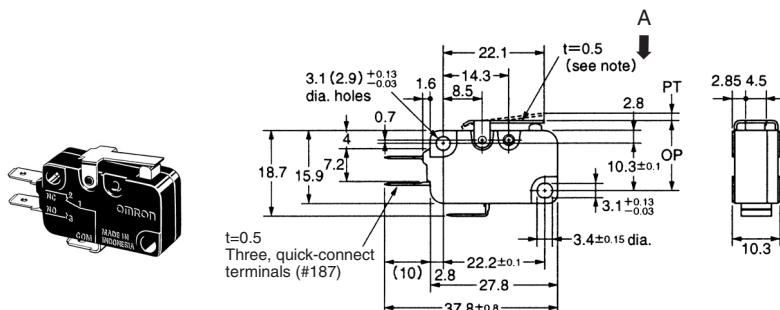

Note: Stainless-steel lever.

Model	D3V-21G1M-1□4A-Δ	D3V-161M-1□5-Δ D3V-111M-1□5-Δ	D3V-111M-1□4-Δ D3V-61M-1□4-Δ	D3V-6G1M-1□3-Δ	D3V-011M-1□3-Δ
OF max.	125 g {1.23 N}	200 g {1.96 N}	100 g {0.98 N}	50 g {0.49 N}	
RF min.	20 g {0.20 N}	50 g {0.49 N}	15 g {0.15 N}	5 g {0.05 N}	
PT max.	1.6 mm	1.6 mm			1.6 mm
OT min.	0.8 mm	0.8 mm			0.8 mm
MD max.	0.5 mm	0.6 mm (F gap type) or 0.5 mm (G gap type)			0.6 mm
OP	15.2±0.5 mm				

Hinge Lever Models

- D3V-21G2M-1□4A-Δ
- D3V-162M-1□5-Δ
- D3V-112M-1□5-Δ
- D3V-112M-1□4-Δ
- D3V-62M-1□4-Δ
- D3V-6G2M-1□3-Δ
- D3V-012M-1□3-Δ

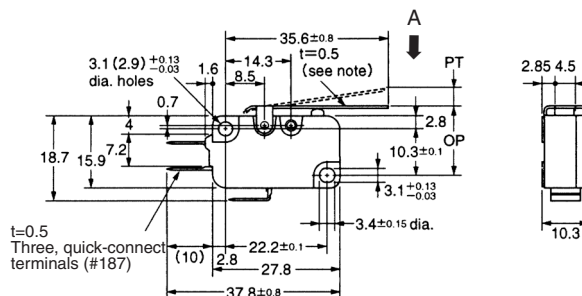

Note: Stainless-steel lever.

Model	D3V-21G2M-1□4A-Δ	D3V-162M-1□5-Δ D3V-112M-1□5-Δ	D3V-112M-1□4-Δ D3V-62M-1□4-Δ	D3V-6G2M-1□3-Δ	D3V-012M-1□3-Δ
OF max.	80 g {0.78 N}	125 g {1.23 N}	60 g {0.59 N}		30 g {0.29 N}
RF min.	6 g {0.06 N}	14 g {0.14 N}	6 g {0.06 N}		---
PT max.	4.0 mm	4.0 mm			4.0 mm
OT min.	1.6 mm	1.6 mm			1.6 mm
MD max.	0.8 mm	1.5 mm (F gap type) or 0.8 mm (G gap type)			1.5 mm
OP	15.2±1.2 mm				

Long Hinge Lever Models

- D3V-21G3M-1□4A-Δ
- D3V-163M-1□5-Δ
- D3V-113M-1□5-Δ
- D3V-113M-1□4-Δ
- D3V-63M-1□4-Δ
- D3V-6G3M-1□3-Δ
- D3V-013M-1□3-Δ

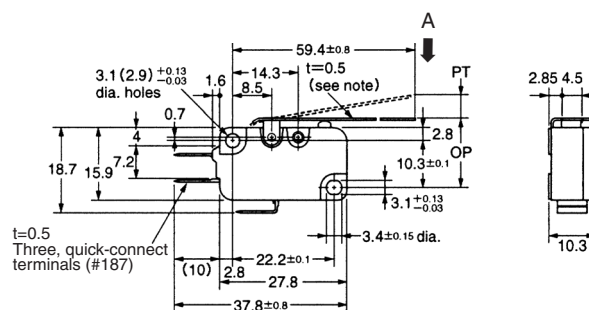

Note: Stainless-steel lever.

Model	D3V-21G3M-1□4A-Δ	D3V-163M-1□5-Δ D3V-113M-1□5-Δ	D3V-113M-1□4-Δ D3V-63M-1□4-Δ	D3V-6G3M-1□3-Δ	D3V-013M-1□3-Δ
OF max.	45 g {0.44 N}	70 g {0.69 N}	35 g {0.34 N}	20 g {0.20 N}	
RF min.	3 g {0.03 N}	6 g {0.06 N}	---	---	
PT max.	9.0 mm	9.0 mm	9.0 mm		9.0 mm
OT min.	2.0 mm	2.0 mm	3.2 mm		3.2 mm
MD max.	2.0 mm	2.8 mm (F gap type) or 2.0 mm (G gap type)	2.8 mm (F gap type) or 2.0 mm (G gap type)		2.8 mm
OP	15.2 ^{+2.6} _{-3.2} mm		15.2±2.6 mm		

Simulated Roller Lever Models

- D3V-21G3M-1□4A-Δ
- D3V-164M-1□5-Δ
- D3V-114M-1□5-Δ
- D3V-114M-1□4-Δ
- D3V-64M-1□4-Δ
- D3V-6G4M-1□3-Δ
- D3V-014M-1□3-Δ

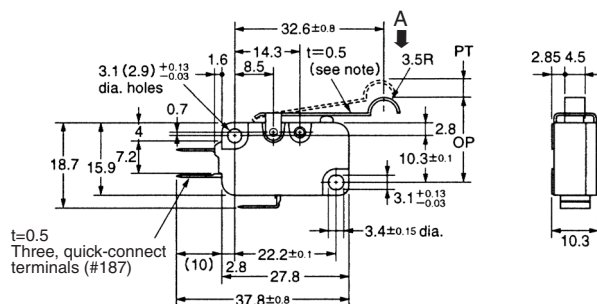

Note: Stainless-steel lever.

Model	D3V-21G4M-1□4A-Δ	D3V-164M-1□5-Δ D3V-114M-1□5-Δ	D3V-114M-1□4-Δ D3V-64M-1□4-Δ	D3V-6G4M-1□3-Δ	D3V-014M-1□3-Δ
OF max.	85 g {0.83 N}	125 g {1.23 N}	60 g {0.59 N}	30 g {0.29 N}	
RF min.	7 g {0.07 N}	14 g {0.14 N}	6 g {0.06 N}	---	
PT max.	4.0 mm	4.0 mm			4.0 mm
OT min.	1.6 mm	1.6 mm			1.6 mm
MD max.	1.4 mm	1.5 mm (F gap type) or 0.8 mm (G gap type)			1.5 mm
OP	18.7±1.2 mm				

Short Hinge Roller Lever Models

- D3V-21G5M-1□4A-Δ
- D3V-165M-1□5-Δ
- D3V-115M-1□5-Δ
- D3V-115M-1□4-Δ
- D3V-65M-1□4-Δ
- D3V-6G5M-1□3-Δ
- D3V-015M-1□3-Δ

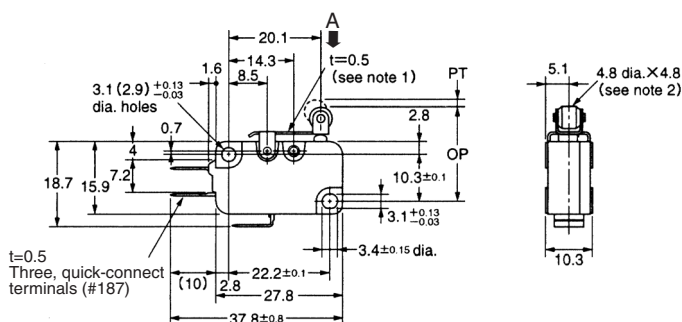

- Note: 1. Stainless-steel lever.
2. Oilless polyacetal resin roller.

Model	D3V-21G5M-1□4A-Δ	D3V-165M-1□5-Δ D3V-115M-1□5-Δ	D3V-115M-1□4-Δ D3V-65M-1□4-Δ	D3V-6G5M-1□3-Δ	D3V-015M-1□3-Δ
OF max.	145 g {1.42 N}	240 g {2.35 N}	120 g {1.18 N}	60 g {0.59 N}	
RF min.	20 g {0.2 N}	50 g {0.49 N}	15 g {0.15 N}	6 g {0.06 N}	
PT max.	1.6 mm	1.6 mm			1.6 mm
OT min.	0.8 mm	0.8 mm			0.8 mm
MD max.	0.5 mm	0.6 mm (F gap type) or 0.5 mm (G gap type)			0.6 mm
OP	20.7±0.6 mm				

Hinge Roller Lever Models

- D3V-21G6M-1□4A-Δ
- D3V-166M-1□5-Δ
- D3V-116M-1□5-Δ
- D3V-116M-1□4-Δ
- D3V-66M-1□4-Δ
- D3V-6G6M-1□3-Δ
- D3V-016M-1□3-Δ

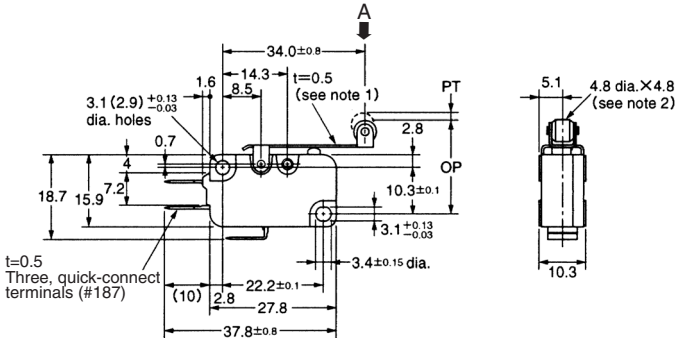

- Note:** 1. Stainless-steel lever.
 2. Oilless polyacetal resin roller.

Model	D3V-21G6M-1□4A-Δ	D3V-166M-1□5-Δ D3V-116M-1□5-Δ	D3V-116M-1□4-Δ D3V-66M-1□4-Δ	D3V-6G6M-1□3-Δ	D3V-016M-1□3-Δ
OF max.	80 g {0.79 N}	125 g {1.23 N}	60 g {0.59 N}	30 g {0.29 N}	
RF min.	5 g {0.05 N}	14 g {0.14 N}	6 g {0.06 N}	---	
PT max.	4.0 mm	4.0 mm			4.0 mm
OT min.	1.6 mm	1.6 mm			1.6 mm
MD max.	0.8 mm	1.5 mm (F gap type) or 0.8 mm (G gap type)			1.5 mm
OP	20.7±1.2 mm				

Precautions

■ Cautions

Handling

Be careful not to drop the switch. Doing so may cause damage to the switch's internal components because it is designed for a small load.

■ Correct Use

Mounting

Use two M3 mounting screws with an appropriate screwdriver to mount the switch. Tighten the screws to a torque of 0.39 to 0.59 N • m {4 to 6 kgf • cm}.

Mounting Direction

Mount lever-operated switches with a maximum operating force of 0.49 N in a direction where the actuator weight will not be applied to the switch. Since the switch is designed for a small load, its resetting force is small. Therefore, resetting failure may occur if unnecessary load is applied to the switch.

Insulation Distance

According to EN61058-1, the minimum insulation thickness for this switch should be 1.1 mm and minimum clearance distance between the terminal and mounting plate should be 1.9 mm. If the insulation distance cannot be provided in the product incorporating the switch, either use a switch with insulation barrier or use a Separator to ensure sufficient insulation distance.

Using Micro Loads

Using a model for ordinary loads to open or close the contact of a micro load circuit may result faulty contact. Use models that operate within the operating range shown below, if inrush current occurs when the contact is opened or closed, it may increase contact wear and so decrease life expectancy. Therefore, insert a contact protection circuit where necessary.

The minimum applicable load is the N-level reference value. This value indicates the malfunction reference level for the reliability level of 60% ($\lambda 60$). The equation, $\lambda 60 = 0.5 \times 10^{-6}/\text{operations}$ indicates that the estimated malfunction rate is less than 1/2,000,000 operations with a reliability level of 60%.

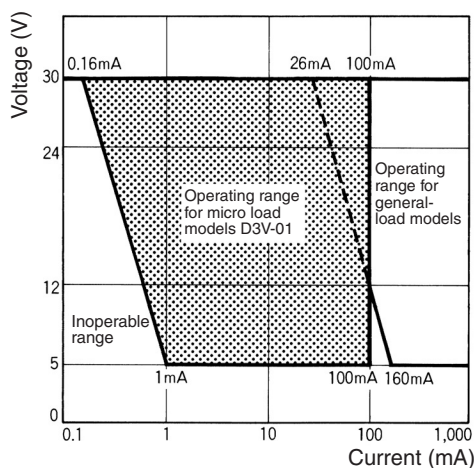

Solder Terminal Approval Conditions

Use of soldering iron for normal soldering is acceptable. Soldering hook holes version available.
Soldering terminal types 1 and 2 are met.

MEMO

A large grid of dashed lines for taking notes, consisting of 20 columns and 25 rows of squares.

Terms and Conditions of Sale

1. Offer; Acceptance. These terms and conditions (these "Terms") are deemed part of all quotations, acknowledgments, invoices, purchase orders and other documents, whether electronic or in writing, relating to the sale of products or services (collectively, the "Products") by Omron Electronic Components LLC ("Seller"). Seller hereby objects to any terms or conditions proposed in Buyer's purchase order or other documents which are inconsistent with, or in addition to, these Terms.
2. Prices; Payment. All prices stated are current, subject to change without notice by Seller. Buyer agrees to pay the price in effect at time of shipment. Payments for Products received are due net 30 days unless otherwise stated in the invoice.
3. Discounts. Cash discounts, if any, will apply only on the net amount of invoices sent to Buyer after deducting transportation charges, taxes and duties, and will be allowed only if (i) the invoice is paid according to Seller's payment terms and (ii) Buyer has no past due amounts owing to Seller.
4. Currencies. If the prices quoted herein are in a currency other than U.S. dollars, Buyer shall make remittance to Seller at the then current exchange rate most favorable to Seller and which is available on the due date; provided that if remittance is not made when due, Buyer will convert the amount to U.S. dollars at the then current exchange rate most favorable to Seller available during the period between the due date and the date remittance is actually made.
5. Governmental Approvals. Buyer shall be responsible for, and shall bear all costs involved in, obtaining any government approvals required for the importation or sale of the Products.
6. Taxes. All taxes, duties and other governmental charges (other than general real property and income taxes), including any interest or penalties thereon, imposed directly or indirectly on Seller or required to be collected directly or indirectly by Seller for the manufacture, production, sale, delivery, importation, consumption or use of the Products sold hereunder (including customs duties and sales, excise, use, turnover and license taxes) shall be charged to and remitted by Buyer to Seller.
7. Financial. If the financial position of Buyer at any time becomes unsatisfactory to Seller, Seller reserves the right to stop shipments or require satisfactory security or payment in advance. If Buyer fails to make payment or otherwise comply with these Terms or any related agreement, Seller may (without liability and in addition to other remedies) cancel any unshipped portion of Products sold hereunder and stop any Products in transit until Buyer pays all amounts, including amounts payable hereunder, whether or not then due, which are owing to it by Buyer. Buyer shall in any event remain liable for all unpaid accounts.
8. Cancellation; Etc. Orders are not subject to rescheduling or cancellation unless Buyer indemnifies Seller fully against all costs or expenses arising in connection therewith.
9. Force Majeure. Seller shall not be liable for any delay or failure in delivery resulting from causes beyond its control, including earthquakes, fires, floods, strikes or other labor disputes, shortage of labor or materials, accidents to machinery, acts of sabotage, riots, delay in or lack of transportation or the requirements of any government authority.
10. Shipping; Delivery. Unless otherwise expressly agreed in writing by Seller:
 1. Shipments shall be by a carrier selected by Seller;
 2. Such carrier shall act as the agent of Buyer and delivery to such carrier shall constitute delivery to Buyer;
 3. All sales and shipments of Products shall be FOB shipping point (unless otherwise stated in writing by Seller), at which point title to and all risk of loss of the Products shall pass from Seller to Buyer, provided that Seller shall retain a security interest in the Products until the full purchase price is paid by Buyer;
 4. Delivery and shipping dates are estimates only.
 5. Seller will package Products as it deems proper for protection against normal handling and extra charges apply to special conditions.
11. Claims. Any claim by Buyer against Seller for shortage or damage to the Products occurring before delivery to the carrier must be presented in writing to Seller within 30 days of receipt of shipment and include the original transportation bill signed by the carrier noting that the carrier received the Products from Seller in the condition claimed.
12. Warranties. (a) Exclusive Warranty. Seller's exclusive warranty is that the Products will be free from defects in materials and workmanship for a period of twelve months from the date of sale by Seller (or such other period expressed in writing by Seller). Seller disclaims all other warranties, express or implied. (b) Limitations. SELLER MAKES NO WARRANTY OR REPRESENTATION, EXPRESS OR IMPLIED, ABOUT NON-INFRINGEMENT, MERCHANTABILITY OR FITNESS FOR A PARTICULAR PURPOSE OF THE PRODUCTS. BUYER ACKNOWLEDGES THAT IT ALONE HAS DETERMINED THAT THE PRODUCTS WILL SUITABLY MEET THE REQUIREMENTS OF THEIR INTENDED USE. Seller further disclaims all warranties and responsibility of any type for claims or expenses based on infringement by the Products or otherwise of any intellectual property right. (c) Buyer Remedy. Seller's sole obligation hereunder shall be to replace (in the form originally shipped with Buyer responsible for labor charges for removal or replacement thereof) the non-complying Product or, at Seller's election, to repay or credit Buyer an amount equal to the purchase price of the Product; provided that in no event shall Seller be responsible for warranty, repair, indemnity or any other claims or expenses regarding the Products unless Seller's analysis confirms that the Products were properly handled, stored, installed and maintained and not subject to contamination, abuse, misuse or inappropriate modification. Return of any Products by Buyer must be approved in writing by Seller before shipment. Seller shall not be liable for the suitability or unsuitability or the results from the use of Products in combination with any electrical or electronic components, circuits, system assemblies, or any other materials or substances or environments. Any advice, recommendations or information given orally or in writing are not to be construed as an amendment to the above warranty.
13. Limitation on Liability; Etc. SELLER SHALL NOT BE LIABLE FOR SPECIAL, INDIRECT, INCIDENTAL OR CONSEQUENTIAL DAMAGES, LOSS OF PROFITS OR PRODUCTION OR COMMERCIAL LOSS IN ANY WAY CONNECTED WITH THE PRODUCTS, WHETHER SUCH CLAIM IS BASED IN CONTRACT, WARRANTY, NEGLIGENCE OR STRICT LIABILITY. Further, in no event shall liability of Seller exceed the individual price of the Product on which liability is asserted.
14. Indemnities. Buyer shall indemnify and hold harmless Seller, its affiliates and its employees from and against all liabilities, losses, claims, costs and expenses (including attorney's fees and expenses) related to any claim, investigation, litigation or proceeding (whether or not Seller is a party) which arises or is alleged to arise from Buyer's acts or omissions under these Terms or in any way with respect to the Products. Without limiting the foregoing, Buyer (at its own expense) shall indemnify and hold harmless Seller and defend or settle any action brought against Seller to the extent that it is based on a claim that any Product made to Buyer specifications infringed intellectual property rights of another party.
15. Property; Confidentiality. The intellectual property embodied in the Products is the exclusive property of Seller and its affiliates and Buyer shall not attempt to duplicate it in any way without the written permission of Seller. Notwithstanding any charges to Buyer for engineering or tooling, all engineering and tooling supplied by Seller to Buyer relating to the Products are confidential and proprietary, and Buyer shall limit distribution thereof to its trusted employees and strictly prevent disclosure to any third party.
16. Miscellaneous. (a) Waiver. No failure or delay by Seller in exercising any right and no course of dealing between Buyer and Seller shall operate as a waiver of rights by Seller. (b) Assignment. Buyer may not assign its rights hereunder without Seller's written consent. (c) Law. These Terms are governed by Illinois law (without regard to conflict of law principles). Federal and state courts in Illinois shall have exclusive jurisdiction for any dispute hereunder. (d) Amendment. These Terms constitute the entire agreement between Buyer and Seller relating to the Products, and no provision may be changed or waived unless in writing signed by the parties. (e) Severability. If any provision hereof is rendered ineffective or invalid, such provision shall not invalidate any other provision. (f) Setoff. Buyer shall have no right to set off any amounts against the amount owing in respect of this invoice. (g) Definitions. As used herein, "including" means "including without limitation".

Certain Precautions on Specifications and Use

1. **Suitability for Use.** Seller shall not be responsible for conformity with any standards, codes or regulations which apply to the combination of the Product in Buyer's application or use of the Product. At Buyer's request, Seller will provide applicable third party certification documents identifying ratings and limitations of use which apply to the Product. This information by itself is not sufficient for a complete determination of the suitability of the Product in combination with the end product, machine, system, or other application or use. Buyer shall be solely responsible for determining appropriateness of the particular Product with respect to Buyer's application, product or system. Buyer shall take application responsibility in all cases but the following is a non-exhaustive list of applications for which particular attention must be given:
 - (i) Outdoor use, uses involving potential chemical contamination or electrical interference, or conditions or uses not described in this document.
 - (ii) Energy control systems, combustion systems, railroad systems, aviation systems, medical equipment, amusement machines, vehicles, safety equipment, and installations subject to separate industry or government regulations.
 - (iii) Use in consumer products or any use in significant quantities.
 - (iv) Systems, machines and equipment that could present a risk to life or property. Please know and observe all prohibitions of use applicable to this product.

NEVER USE THE PRODUCT FOR AN APPLICATION INVOLVING SERIOUS RISK TO LIFE OR PROPERTY WITHOUT ENSURING THAT THE SYSTEM AS A WHOLE HAS BEEN DESIGNED TO ADDRESS THE RISKS, AND THAT THE OMRON PRODUCT IS PROPERLY RATED AND INSTALLED FOR THE INTENDED USE WITHIN THE OVERALL EQUIPMENT OR SYSTEM.
2. **Programmable Products.** Seller shall not be responsible for the user's programming of a programmable product, or any consequence thereof.
3. **Performance Data.** Performance data given in this publication is provided as a guide for the user in determining suitability and does not constitute a warranty. It may represent the result of Seller's test conditions, and the users must correlate it to actual application requirements. Actual performance is subject to Seller's Warranty and Limitations of Liability.
4. **Change in Specifications.** Product specifications and accessories may be changed at any time based on improvements and other reasons. It is our practice to change part numbers when published ratings or features are changed or when significant construction changes are made. However, some specifications of the Product may be changed without any notice. When in doubt, special part numbers may be assigned to fix or establish key specifications for your application. Please consult with your Seller representative at any time to confirm actual specifications of purchased Product.
5. **Errors and Omissions.** The information in this publication has been carefully checked and is believed to be accurate; however, no responsibility is assumed for clerical, typographical or proofreading errors, or omissions.
6. **RoHS Compliance.** Where indicated, our products currently comply, to the best of our knowledge as of the date of this publication, with the requirements of the European Union's Directive on the Restriction of certain Hazardous Substances ("RoHS"), although the requirements of RoHS do not take effect until July 2006. These requirements may be subject to change. Please consult our website for current information.

Complete "Terms and Conditions of Sale" for product purchase and use are on Omron's website at www.components.omron.com – under the "About Us" tab, in the Legal Matters section.

ALL DIMENSIONS SHOWN ARE IN MILLIMETERS.

To convert millimeters into inches, multiply by 0.03937. To convert grams into ounces, multiply by 0.03527.

OMRON®

**OMRON ELECTRONIC
COMPONENTS LLC**

55 E. Commerce Drive, Suite B
Schaumburg, IL 60173

847-882-2288

OMRON CANADA, INC.

885 Milner Avenue
Toronto, Ontario M1B 5V8

416-286-6465

OMRON ON-LINE

Global - <http://www.omron.com>

USA - <http://www.components.omron.com>

Canada - <http://www.omron.ca>