

BGA777L7

Single-Band UMTS LNA
(2300 - 2700 MHz)

RF & Protection Devices



Never stop thinking

Edition 2009-07-02

**Published by
Infineon Technologies AG
81726 München, Germany**

**© Infineon Technologies AG 2009.
All Rights Reserved.**

Legal Disclaimer

The information given in this document shall in no event be regarded as a guarantee of conditions or characteristics ("Beschaffenhheitsgarantie"). With respect to any examples or hints given herein, any typical values stated herein and/or any information regarding the application of the device, Infineon Technologies hereby disclaims any and all warranties and liabilities of any kind, including without limitation warranties of non-infringement of intellectual property rights of any third party.

Information

For further information on technology, delivery terms and conditions and prices please contact your nearest Infineon Technologies Office (www.infineon.com).

Warnings

Due to technical requirements components may contain dangerous substances. For information on the types in question please contact your nearest Infineon Technologies Office.

Infineon Technologies Components may only be used in life-support devices or systems with the express written approval of Infineon Technologies, if a failure of such components can reasonably be expected to cause the failure of that life-support device or system, or to affect the safety or effectiveness of that device or system. Life support devices or systems are intended to be implanted in the human body, or to support and/or maintain and sustain and/or protect human life. If they fail, it is reasonable to assume that the health of the user or other persons may be endangered.

BGA777L7**Revision History: 2009-07-02, V3.0****Previous Version: 2009-02-18, V1.0 preliminary**

Page	Subjects (major changes since last revision)
7	Updated DC characteristics (added limits)
8	Added supply current and power gain characteristics
9	Updated RF characteristics for application board BGA7xxL7 and added limits
10, 11	Added RF characteristics for UMTS bands 38 and 40
9-11	Updated footnotes
12-16	Updated measured performance for application board BGA7xxL7
17	Updated application circuit schematic for application board BGA7xxL7
18, 19	Added application circuit schematic for UMTS bands 38 and 40
20, 21	Updated application board

Table of Contents

	Table of Contents	4
1	Description	5
2	Electrical Characteristics	6
2.1	Absolute Maximum Ratings	6
2.2	Thermal Resistance	6
2.3	ESD Integrity	6
2.4	DC Characteristics	7
2.5	Gain Mode Select Truth Table	7
2.6	Switching Times	7
2.7	Supply Current and Power Gain Characteristics; $T_A = 25\text{ }^\circ\text{C}$	8
2.8	Logic Signal Characteristics; $T_A = 25\text{ }^\circ\text{C}$	8
2.9	Measured RF Characteristics UMTS Band 7	9
2.10	Measured RF Characteristics UMTS Band 38	10
2.11	Measured RF Characteristics UMTS Band 40	11
2.12	Measured Performance Band 7 Application High Gain Mode vs. Frequency	12
2.13	Measured Performance Band 7 Application High Gain Mode vs. Temperature	13
2.14	Measured Performance Band 7 Application Low Gain Mode vs. Frequency	14
2.15	Measured Performance Band 7 Application Low Gain Mode vs. Temperature	16
3	Application Circuit and Block Diagram	17
3.1	UMTS Band 7 Application Circuit Schematic	17
3.2	UMTS Band 38 Application Circuit Schematic	18
3.3	UMTS Band 40 Application Circuit Schematic	19
3.4	Pin Definition	19
3.5	Application Board	20
4	Physical Characteristics	22
4.1	Package Dimensions	22

1 Description

The BGA777L7 is a low current single-band low noise amplifier MMIC for UMTS bands 7, 38 and 40. The LNA is based upon Infineon's proprietary and cost-effective SiGe:C technology and comes in a low profile TSLP-7-1 leadless green package. This document specifies electrical parameters, pinout, application circuit and packaging of the chip. The device features dynamic gain control, temperature stabilization, standby mode and 2 kV ESD protection on-chip as well as matching off chip.

Features

- Gain: 16 / -7 dB in high / low gain mode
- Noise figure: 1.2 dB in high gain mode
- Supply current: 4.2 / 0.5 mA in high / low gain mode
- Standby mode (< 2 μ A typ.)
- Inputs pre-matched to 50 Ω
- 2 kV HBM ESD protection
- Low external component count
- Small leadless TSLP-7-1 package (2.0 x 1.3 x 0.39 mm)
- Pb-free (RoHS compliant) package

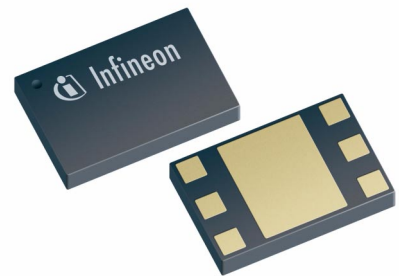

TSLP-7-1 package

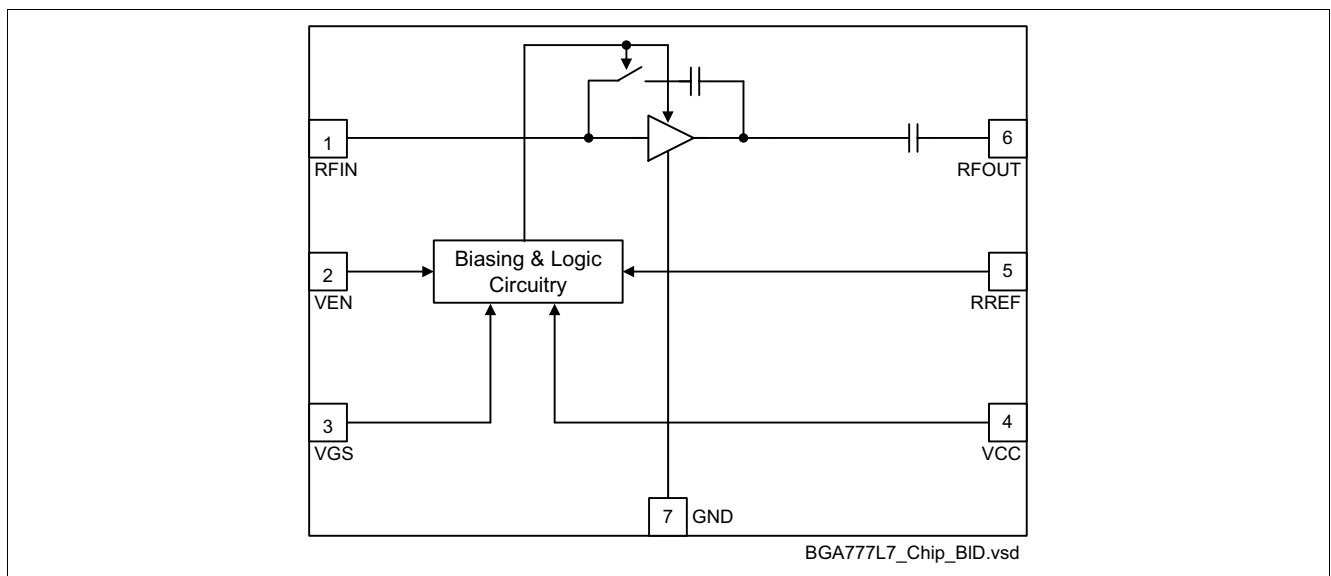

Figure 1 Block diagram of single-band LNA

Type	Package	Marking	Chip
BGA777L7	TSLP-7-1	B7	T1531

2 Electrical Characteristics

2.1 Absolute Maximum Ratings

Table 1 Absolute Maximum Ratings

Parameter	Symbol	Values		Unit	Note / Test Condition
		Min.	Max.		
Supply voltage	V_{CC}	-0.3	3.6	V	
Supply current	I_{CC}		10	mA	
Pin voltage	V_{PIN}	-0.3	$V_{CC} + 0.3$	V	All pins except RF input pin
Pin voltage RF Input Pin	V_{RFIN}	-0.3	0.9	V	
RF input power	P_{RFIN}		4	dBm	
Junction temperature	T_j		150	°C	
Ambient temperature range	T_A	-30	85	°C	
Storage temperature range	T_{stg}	-65	150	°C	

2.2 Thermal Resistance

Table 2 Thermal Resistance

Parameter	Symbol	Value	Unit	Note / Test Conditions
Thermal resistance junction to soldering point	R_{thJS}	240	K/W	

2.3 ESD Integrity

Table 3 ESD Integrity

Parameter	Symbol	Value (typ.)	Unit	Note / Test Conditions
ESD hardness HBM ¹⁾	$V_{ESD-HBM}$	2000	V	All pins

1) According to JESD22-A114

2.4 DC Characteristics

Table 4 DC Characteristics, $T_A = 25\text{ °C}$

Parameter	Symbol	Values			Unit	Note / Test Condition
		Min.	Typ.	Max.		
Supply voltage	V_{CC}	2.6	2.8	3.0	V	
Supply current high gain mode	I_{CCHG}		4.2		mA	
Supply current low gain mode	I_{CCLG}		530		μA	
Supply current standby mode	I_{CCOFF}		0.1	2.0	μA	
Logic level high	V_{HI}	1.5	2.8		V	VEN and VGS
Logic level low	V_{LO}	-0.2	0.0	0.5	V	
Logic currents VEN	I_{ENL}			0.1	μA	VEN
	I_{ENH}		5.0	6.0	μA	
Logic currents VGS	I_{GSL}			0.1	μA	VGS
	I_{GSH}		5.0	6.0	μA	

2.5 Gain Mode Select Truth Table

Table 5 Truth Table

Control Voltage		State	
		Bands 7, 38, 40	
VEN	VGS	HG	LG
H	L	OFF	ON
H	H	ON	OFF
L	L	STANDBY ¹⁾	
L	H		

1) In order to achieve minimum standby current it is encouraged to apply logic low-level at the VGS pin in standby mode although this is not mandatory. Details see section 2.4.

2.6 Switching Times

Table 6 Typical switching times; $T_A = -30 \dots 85\text{ °C}$

Parameter	Symbol	Values			Unit	Note / Test Condition
		Min.	Typ.	Max.		
Settling time gainstep	t_{GS}		1		μs	Switching LG \leftrightarrow HG

2.7 Supply Current and Power Gain Characteristics; $T_A = 25\text{ }^\circ\text{C}$

Supply current and power gain high gain mode versus reference resistor R_{REF} (see Figure 2 on page 17 for reference resistor; low gain mode supply current is independent of reference resistor).

Supply Current $I_{CC} = f(R_{REF})$
 $V_{CC} = 2.8\text{ V}$

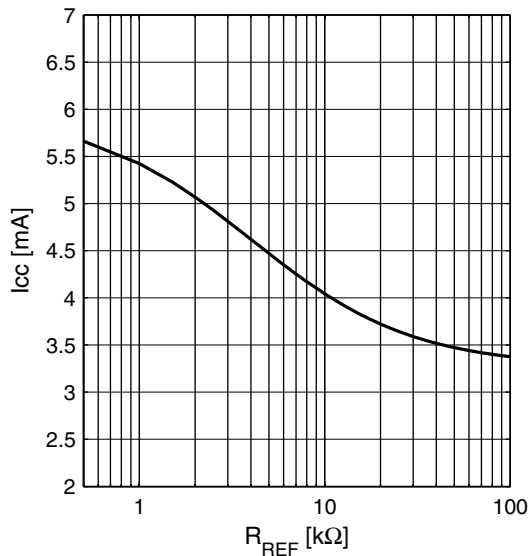

Power Gain $|S_{21}| = f(R_{REF})$
 $V_{CC} = 2.8\text{ V}$

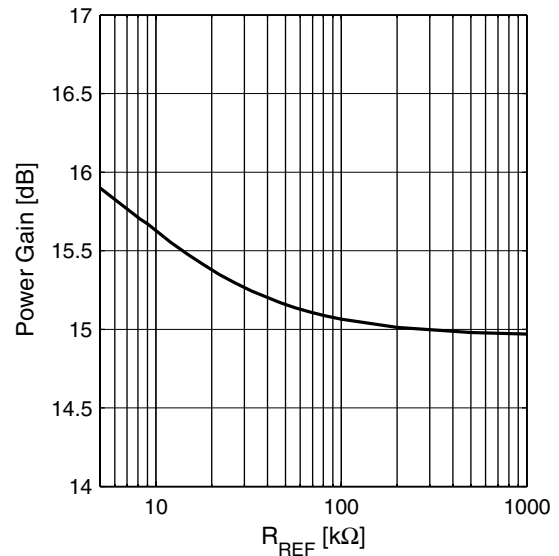

2.8 Logic Signal Characteristics; $T_A = 25\text{ }^\circ\text{C}$

Current consumption of logic inputs V_{EN} , V_{GS}

Logic currents $I_{EN} = f(V_{EN})$
 $V_{CC} = 2.8\text{ V}$

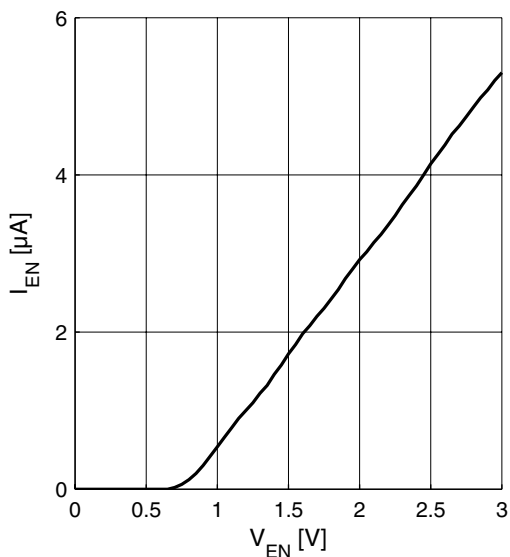

Logic currents $I_{GS} = f(V_{GS})$
 $V_{CC} = 2.8\text{ V}$

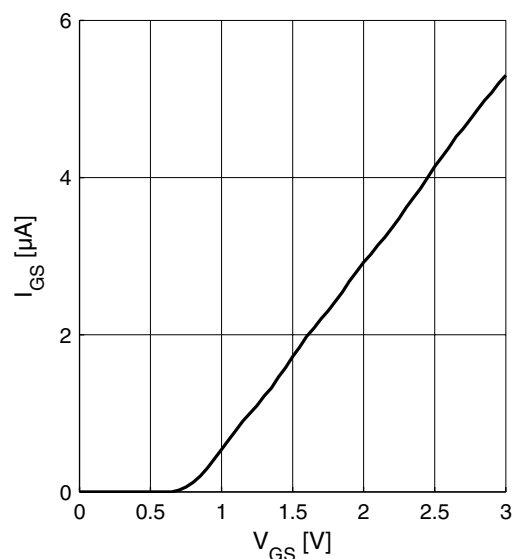

2.9 Measured RF Characteristics UMTS Band 7

Table 7 Typical Characteristics 2650 MHz Band $T_A = 25\text{ °C}$, $V_{CC} = 2.8\text{ V}^1$

Parameter	Symbol	Values			Unit	Note / Test Condition
		Min.	Typ.	Max.		
Pass band range band I		2620		2690	MHz	
Current consumption	I_{CCHG}		4.2	4.9	mA	High gain mode
	I_{CCLG}		0.5	0.8	mA	Low gain mode
Gain	S_{21HG}	14.4	15.7	17.0	dB	High gain mode
	S_{21LG}	-9.6	-7.1	-4.1	dB	Low gain mode
Reverse Isolation ²⁾	S_{12HG}		-34		dB	High gain mode
	S_{12LG}		-7		dB	Low gain mode
Noise figure	NF_{HG}		1.2	1.7	dB	High gain mode
	NF_{LG}		6.8		dB	Low gain mode
Input return loss ²⁾	S_{11HG}		-20		dB	50 Ω , high gain mode
	S_{11LG}		-10		dB	50 Ω , low gain mode
Output return loss ²⁾	S_{22HG}		-20		dB	50 Ω , high gain mode
	S_{22LG}		-11		dB	50 Ω , low gain mode
Stability factor ³⁾	k		>2.3			DC to 10 GHz; all gain modes
Input compression point ²⁾	IP_{1dBHG}		-10		dBm	High gain mode
	$IP_{1dB LG}$		-2		dBm	Low gain mode
Inband IIP3 ²⁾ $f_1 - f_2 = 1\text{ MHz}$ $P_{f1} = P_{f2} = -37\text{ dBm}$	$IIP3_{HG}$		-2		dBm	High gain mode
	$IIP3_{LG}$		7			Low gain mode

1) Performance based on application circuit in Figure 2 on page 17

2) Verified based on AQL; not 100% tested in production

3) Guaranteed by device design; not tested in production

2.10 Measured RF Characteristics UMTS Band 38

Table 8 Typical Characteristics 2600 MHz Band $T_A = 25\text{ °C}$, $V_{CC} = 2.8\text{ V}^1$

Parameter	Symbol	Values			Unit	Note / Test Condition
		Min.	Typ.	Max.		
Pass band range band I		2570		2620	MHz	
Current consumption	I_{CCHG}		4.2		mA	High gain mode
	I_{CCLG}		0.5		mA	Low gain mode
Gain	S_{21HG}		15.5		dB	High gain mode
	S_{21LG}		-6.9		dB	Low gain mode
Reverse Isolation ²⁾	S_{12HG}		-34		dB	High gain mode
	S_{12LG}		-7		dB	Low gain mode
Noise figure	NF_{HG}		1.2		dB	High gain mode
	NF_{LG}		6.8		dB	Low gain mode
Input return loss ²⁾	S_{11HG}		-15		dB	50 Ω , high gain mode
	S_{11LG}		-11		dB	50 Ω , low gain mode
Output return loss ²⁾	S_{22HG}		-15		dB	50 Ω , high gain mode
	S_{22LG}		-13		dB	50 Ω , low gain mode
Stability factor ³⁾	k		>2.3			DC to 10 GHz; all gain modes
Input compression point ²⁾	IP_{1dBHG}		-10		dBm	High gain mode
	$IP_{1dB LG}$		-2		dBm	Low gain mode
Inband IIP3 ²⁾ $f_1 - f_2 = 1\text{ MHz}$ $P_{f1} = P_{f2} = -37\text{ dBm}$	$IIP3_{HG}$		-2		dBm	High gain mode
	$IIP3_{LG}$		7			Low gain mode

1) Performance based on application circuit in Figure 3 on page 18

2) Verified based on AQL; not 100% tested in production

3) Guaranteed by device design; not tested in production

2.11 Measured RF Characteristics UMTS Band 40

Table 9 Typical Characteristics 2300 MHz Band $T_A = 25\text{ °C}$, $V_{CC} = 2.8\text{ V}^1$

Parameter	Symbol	Values			Unit	Note / Test Condition
		Min.	Typ.	Max.		
Pass band range band I		2300		2400	MHz	
Current consumption	I_{CCHG}		4.2		mA	High gain mode
	I_{CCLG}		0.5		mA	Low gain mode
Gain	S_{21HG}		16.8		dB	High gain mode
	S_{21LG}		-7.2		dB	Low gain mode
Reverse Isolation ²⁾	S_{12HG}		-35		dB	High gain mode
	S_{12LG}		-7		dB	Low gain mode
Noise figure	NF_{HG}		1.2		dB	High gain mode
	NF_{LG}		7.0		dB	Low gain mode
Input return loss ²⁾	S_{11HG}		-23		dB	50 Ω , high gain mode
	S_{11LG}		-12		dB	50 Ω , low gain mode
Output return loss ²⁾	S_{22HG}		-15		dB	50 Ω , high gain mode
	S_{22LG}		-12		dB	50 Ω , low gain mode
Stability factor ³⁾	k		>2.3			DC to 10 GHz; all gain modes
Input compression point ²⁾	IP_{1dBHG}		-11		dBm	High gain mode
	$IP_{1dB LG}$		-2		dBm	Low gain mode
Inband IIP3 ²⁾ $f_1 - f_2 = 1\text{ MHz}$ $P_{f1} = P_{f2} = -37\text{ dBm}$	$IIP3_{HG}$		-2		dBm	High gain mode
	$IIP3_{LG}$		8			Low gain mode

1) Performance based on application circuit in Figure 4 on page 19

2) Verified based on AQL; not 100% tested in production

3) Guaranteed by device design; not tested in production

Measured Performance Band 7 Application High Gain Mode vs. Frequency

2.12 Measured Performance Band 7 Application High Gain Mode vs. Frequency

$T_A = 25\text{ }^\circ\text{C}$, $V_{CC} = 2.8\text{ V}$, $V_{GS} = 2.8\text{ V}$, $V_{EN} = 2.8\text{ V}$

Power Gain $|S_{21}| = f(f)$

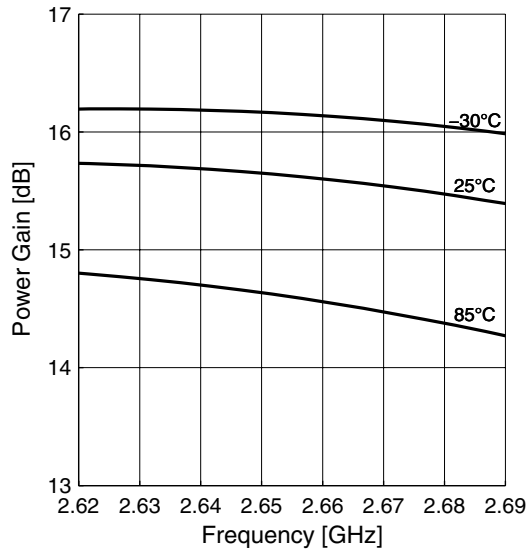

Power Gain Wideband $|S_{21}| = f(f)$

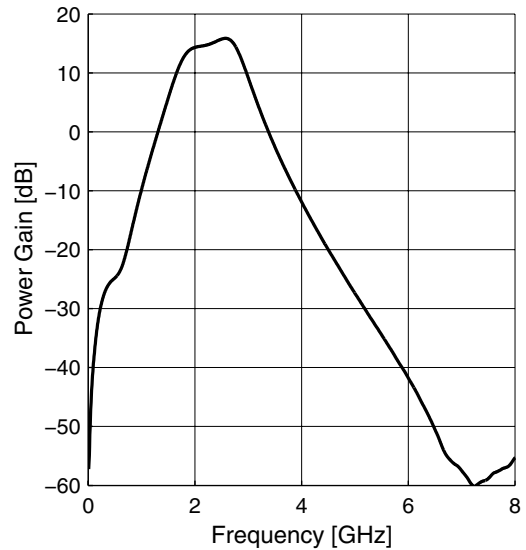

Matching $|S_{11}| = f(f)$, $|S_{22}| = f(f)$

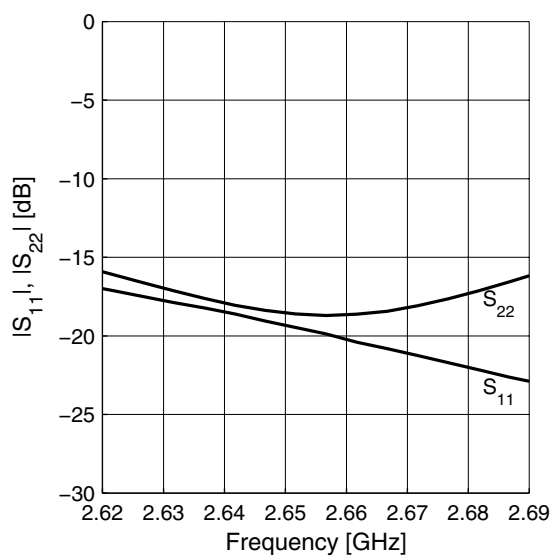

Gainstep HG-LG $|\Delta S_{21}| = f(f)$

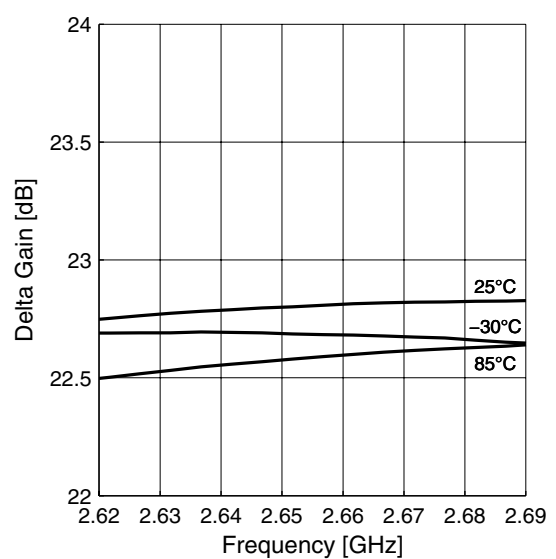

Measured Performance Band 7 Application High Gain Mode vs. Temperature

Noise Figure $NF = f(f)$

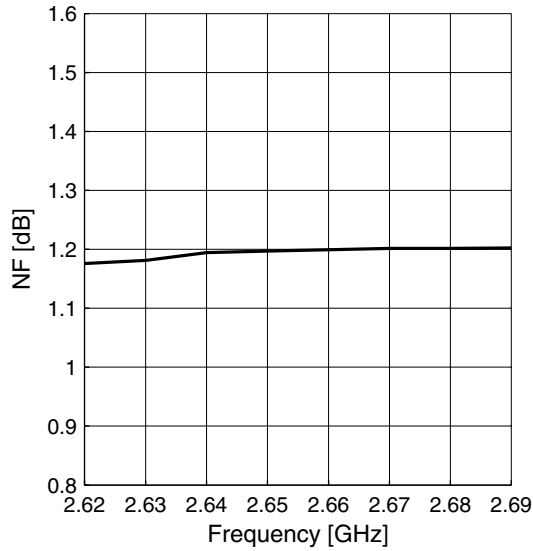

Input Compression $P1dB = f(f)$

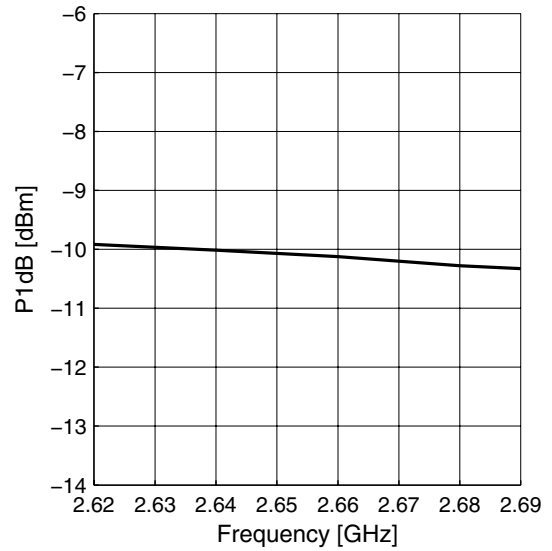

2.13 Measured Performance Band 7 Application High Gain Mode vs. Temperature

$V_{CC} = 2.8 \text{ V}$, $V_{GS} = 2.8 \text{ V}$, $V_{EN} = 2.8 \text{ V}$, $f = 2650 \text{ MHz}$

Power Gain $|S_{21}| = f(T_A)$

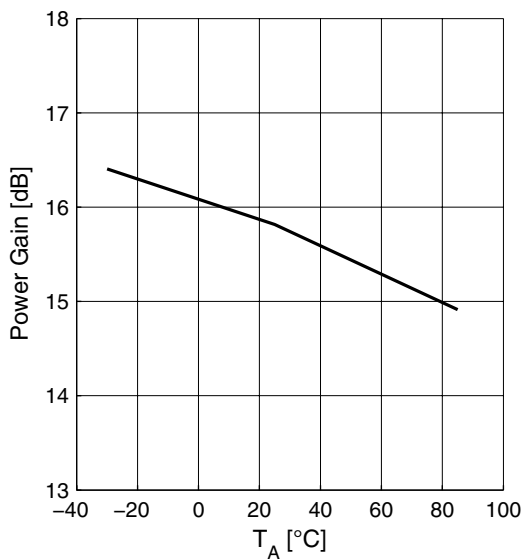

Supply Current $I_{CC} = f(T_A)$

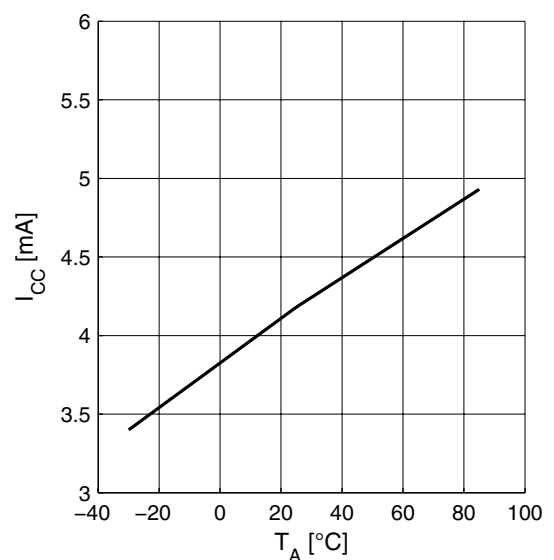

Measured Performance Band 7 Application Low Gain Mode vs. Frequency

Noise Figure $NF = f(T_A)$

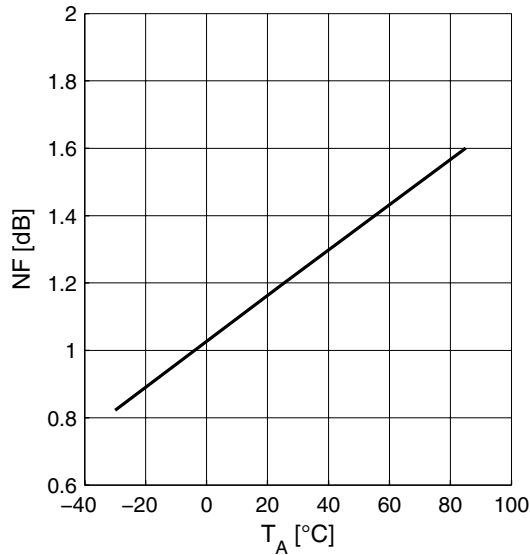

Input Compression $P1dB = f(T_A)$

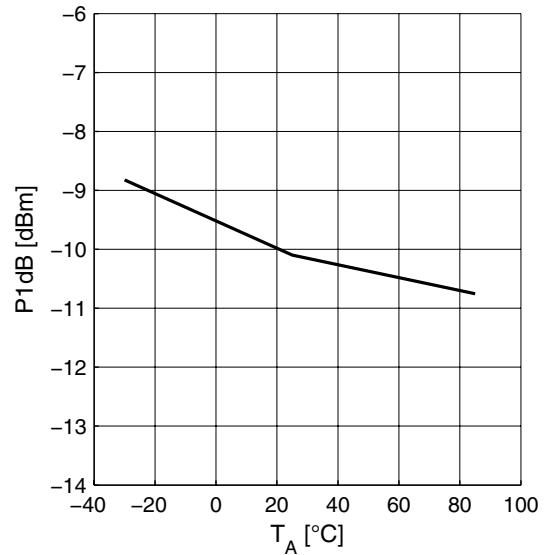

2.14 Measured Performance Band 7 Application Low Gain Mode vs. Frequency

$T_A = 25\text{ °C}$, $V_{CC} = 2.8\text{ V}$, $V_{GS} = 0\text{ V}$, $V_{EN} = 2.8\text{ V}$

Power Gain $|S_{21}| = f(f)$

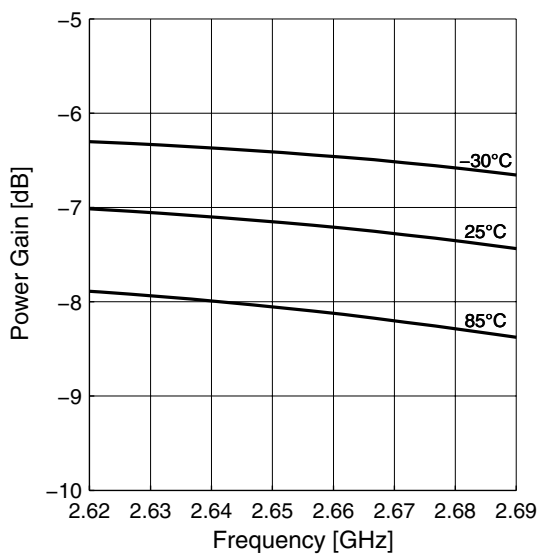

Power Gain Wideband $|S_{21}| = f(f)$

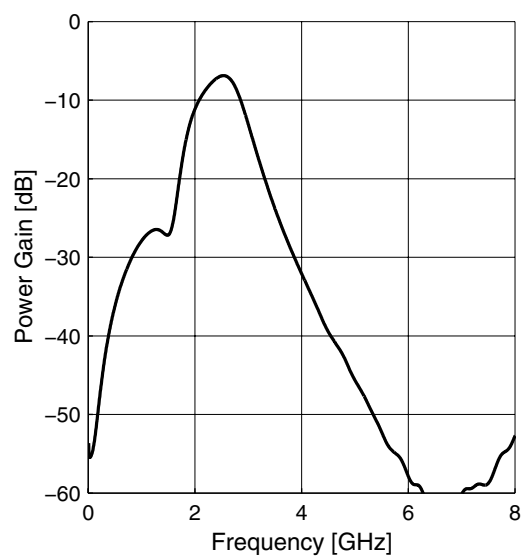

Measured Performance Band 7 Application Low Gain Mode vs. Frequency

Matching $|S_{11}| = f(f)$, $|S_{22}| = f(f)$

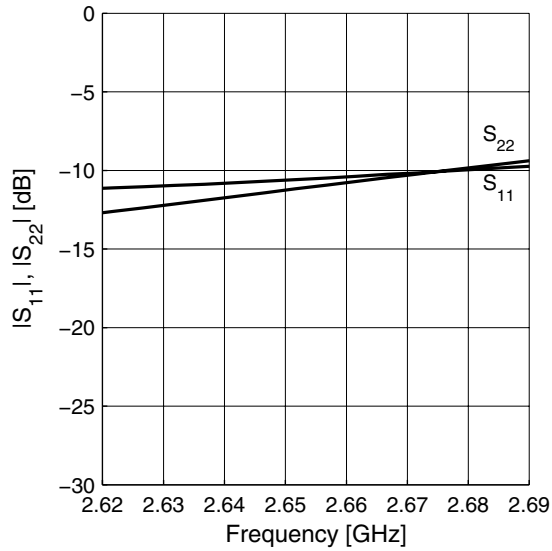

Noise Figure $NF = f(f)$

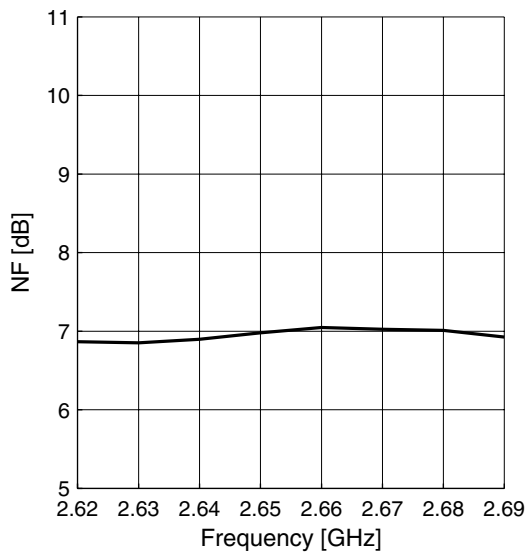

Input Compression $P1dB = f(f)$

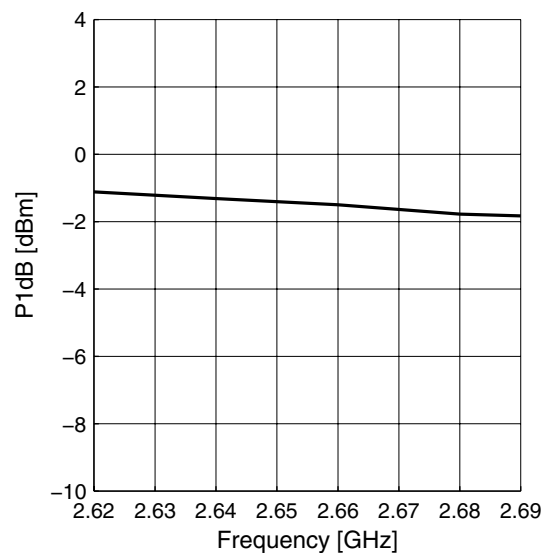

Measured Performance Band 7 Application Low Gain Mode vs. Temperature

2.15 Measured Performance Band 7 Application Low Gain Mode vs. Temperature

$V_{CC} = 2.8\text{ V}$, $V_{GS} = 0\text{ V}$, $V_{EN} = 2.8\text{ V}$, $f = 2650\text{ MHz}$

Power Gain $|S_{21}| = f(T_A)$

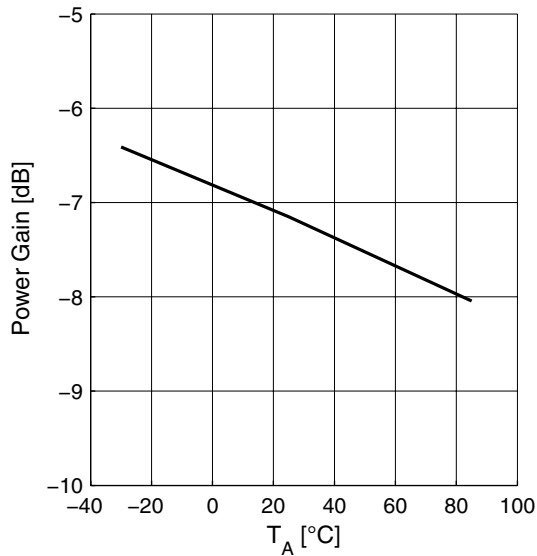

Supply Current $I_{CC} = f(T_A)$

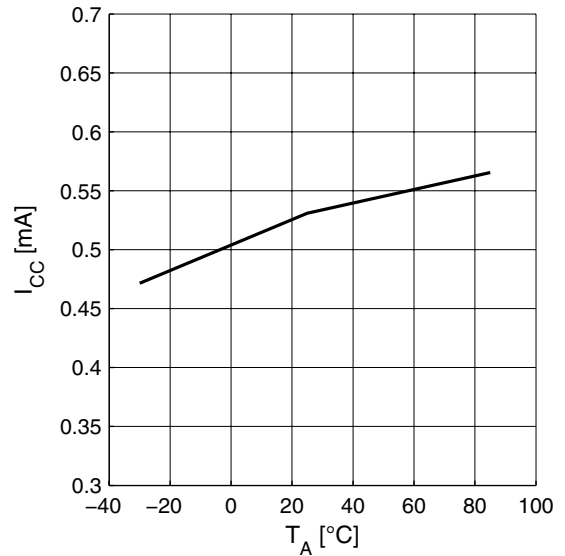

Noise Figure $NF = f(T_A)$

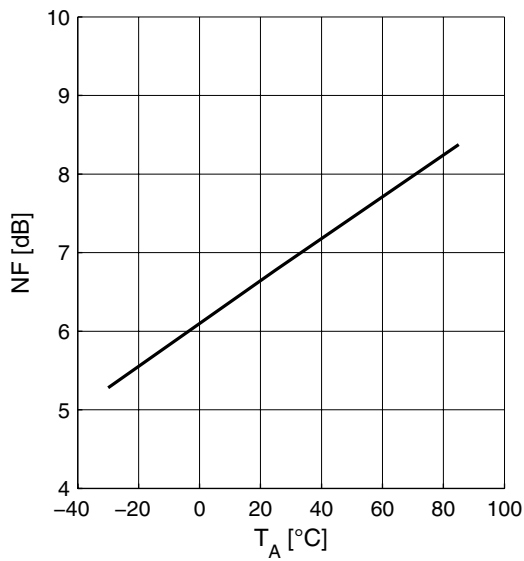

Input Compression $P1dB = f(T_A)$

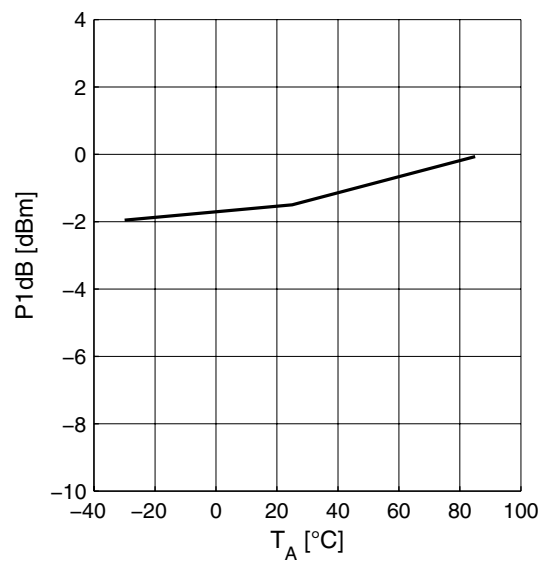

3 Application Circuit and Block Diagram

3.1 UMTS Band 7 Application Circuit Schematic

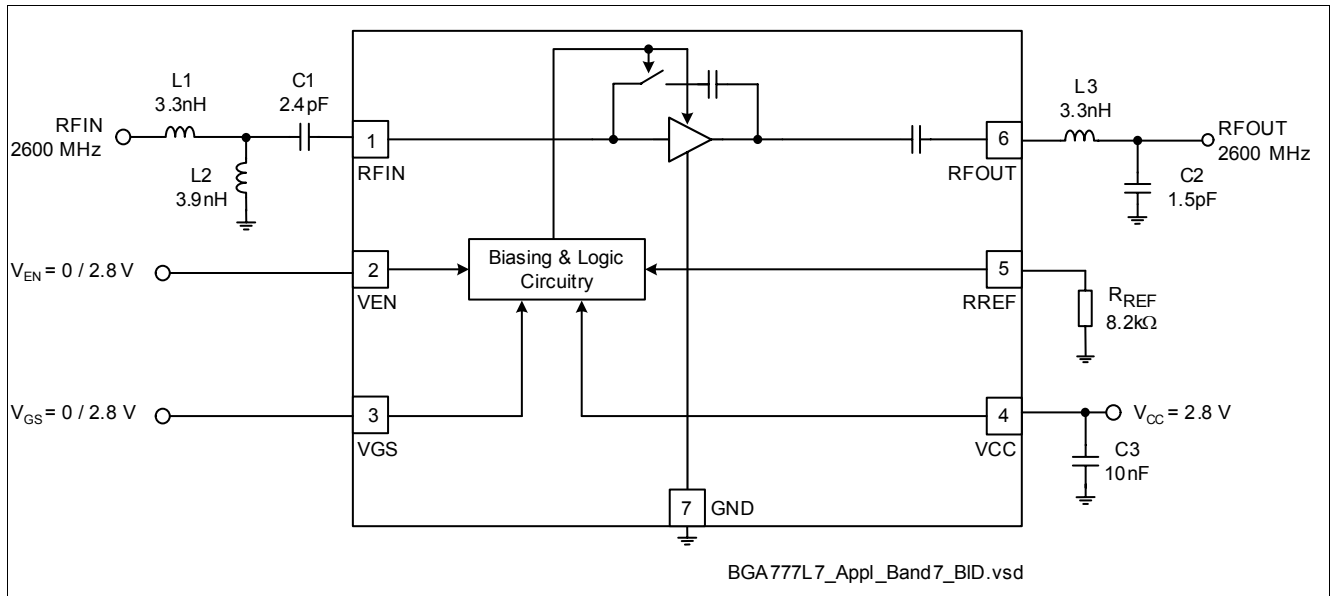

Figure 2 Application circuit with chip outline (top view)

Note: Package paddle (Pin 0) has to be RF grounded.

Table 10 Parts List

Part Number	Part Type	Manufacturer	Size	Comment
L1 ... L3	Chip inductor	Various	0402	Wirewound, $Q \approx 50$
C1 ... C3	Chip capacitor	Various	0402	
RREF	Chip resistor	Various	0402	

3.2 UMTS Band 38 Application Circuit Schematic

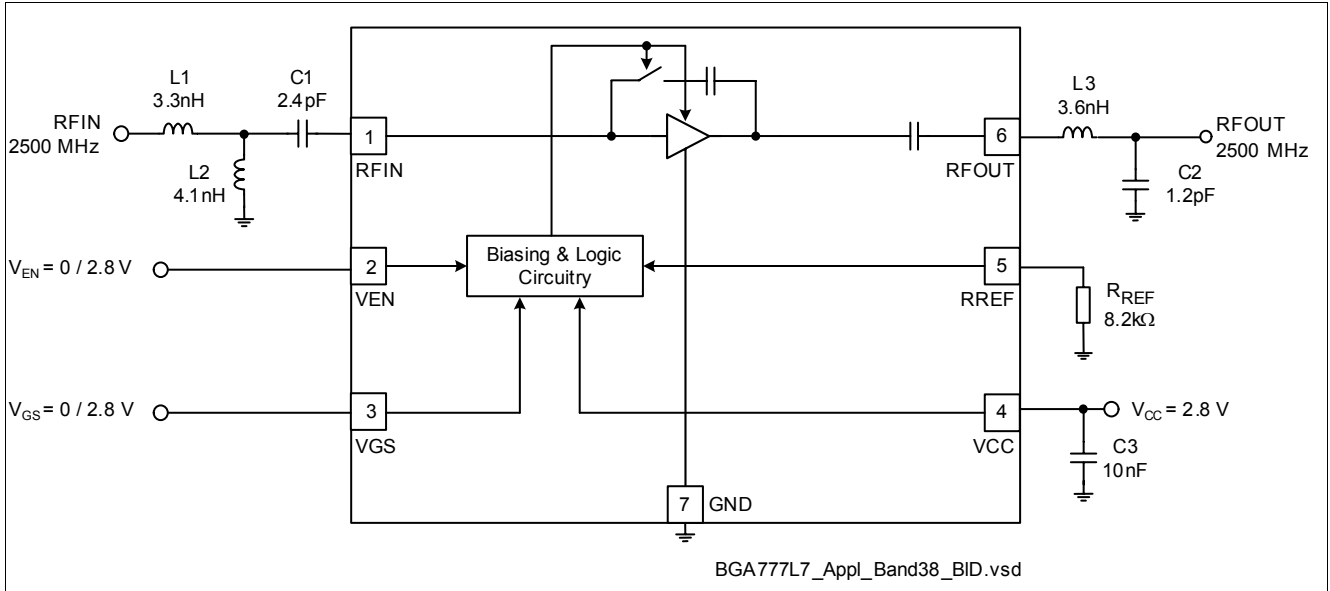

Figure 3 Application circuit with chip outline (top view)

Note: Package paddle (Pin 0) has to be RF grounded.

Table 11 Parts List

Part Number	Part Type	Manufacturer	Size	Comment
L1 ... L3	Chip inductor	Various	0402	Wirewound, Q ≈ 50
C1 ... C3	Chip capacitor	Various	0402	
RREF	Chip resistor	Various	0402	

3.3 UMTS Band 40 Application Circuit Schematic

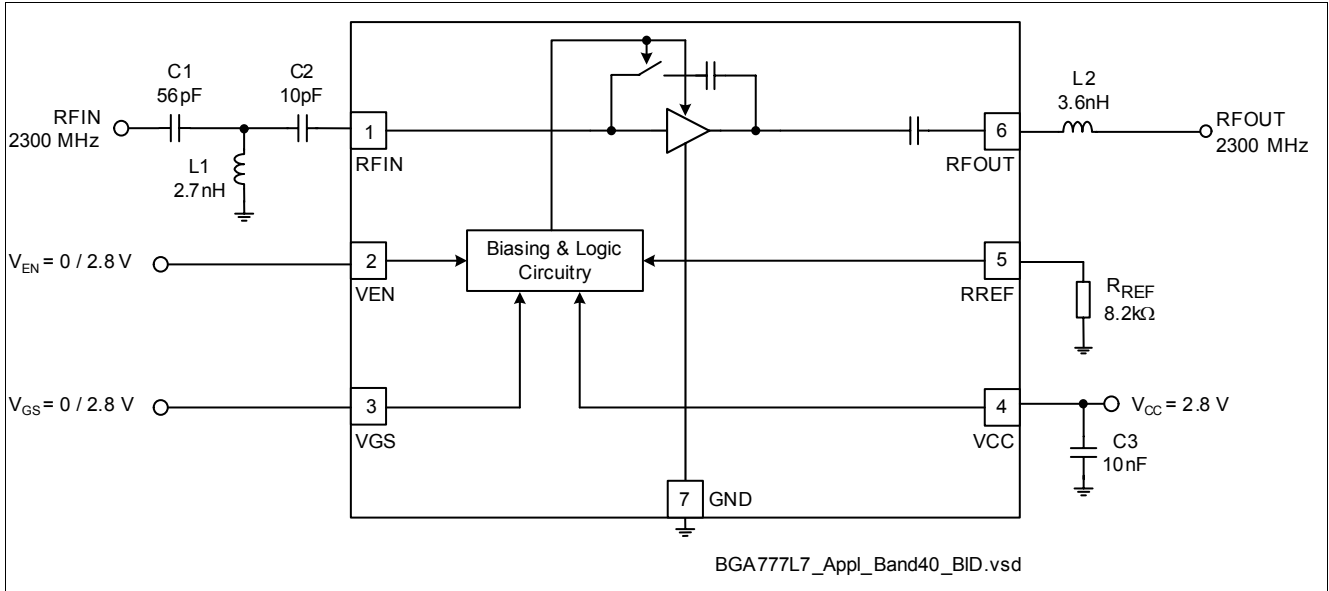

Figure 4 Application circuit with chip outline (top view)

Note: Package paddle (Pin 0) has to be RF grounded.

Table 12 Parts List

Part Number	Part Type	Manufacturer	Size	Comment
L1 ... L2	Chip inductor	Various	0402	Wirewound, Q ≈ 50
C1 ... C3	Chip capacitor	Various	0402	
RREF	Chip resistor	Various	0402	

3.4 Pin Definition

Table 13 Pin Definition and Function

Pin Number	Symbol	Function
1	RFIN	LNA input (2600 MHz)
2	VEN	Band select control
3	VGS	Gain step control
4	VCC	Supply voltage
5	RREF	Bias current reference resistor (high gain mode)
6	RFOUT	LNA output (2600 MHz)
7	GND	Package paddle; ground connection for LNA and control circuitry

3.5 Application Board

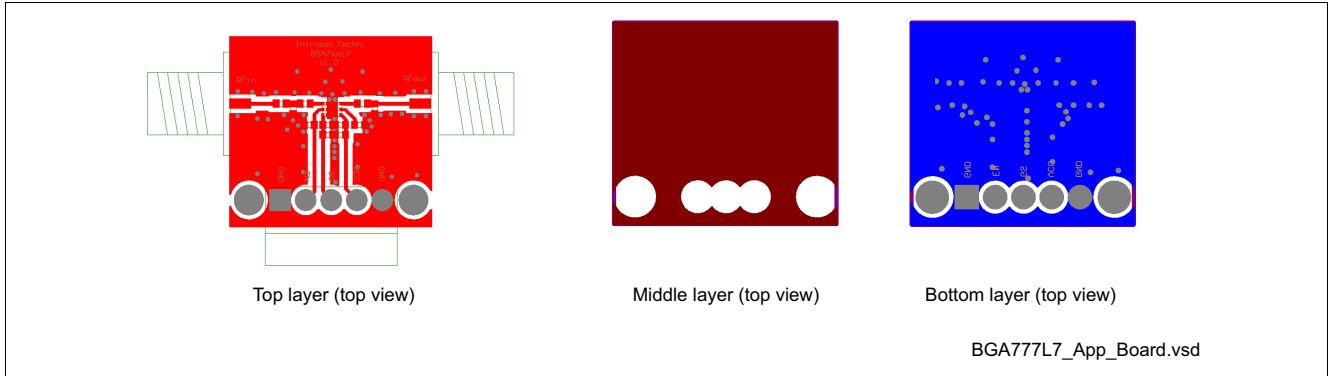

Figure 5 Application board layout on 3-layer FR4. Top layer thickness: 0.2 mm, bottom layer thickness: 0.8 mm, 35 μm Cu metallization, gold plated. Board size: 21 x 19 mm

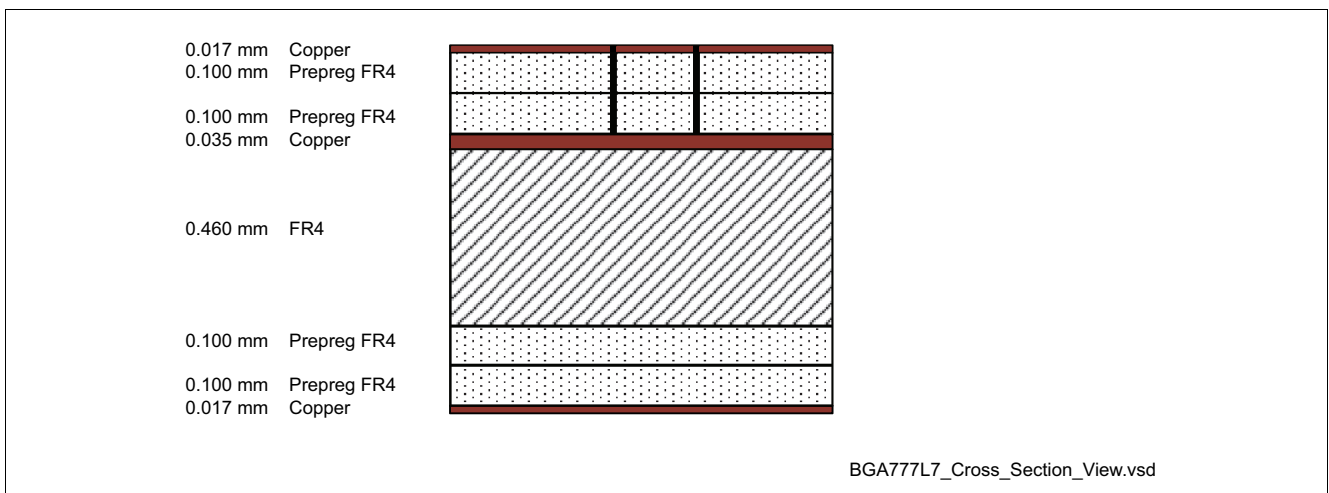

Figure 6 Cross-section view of application board

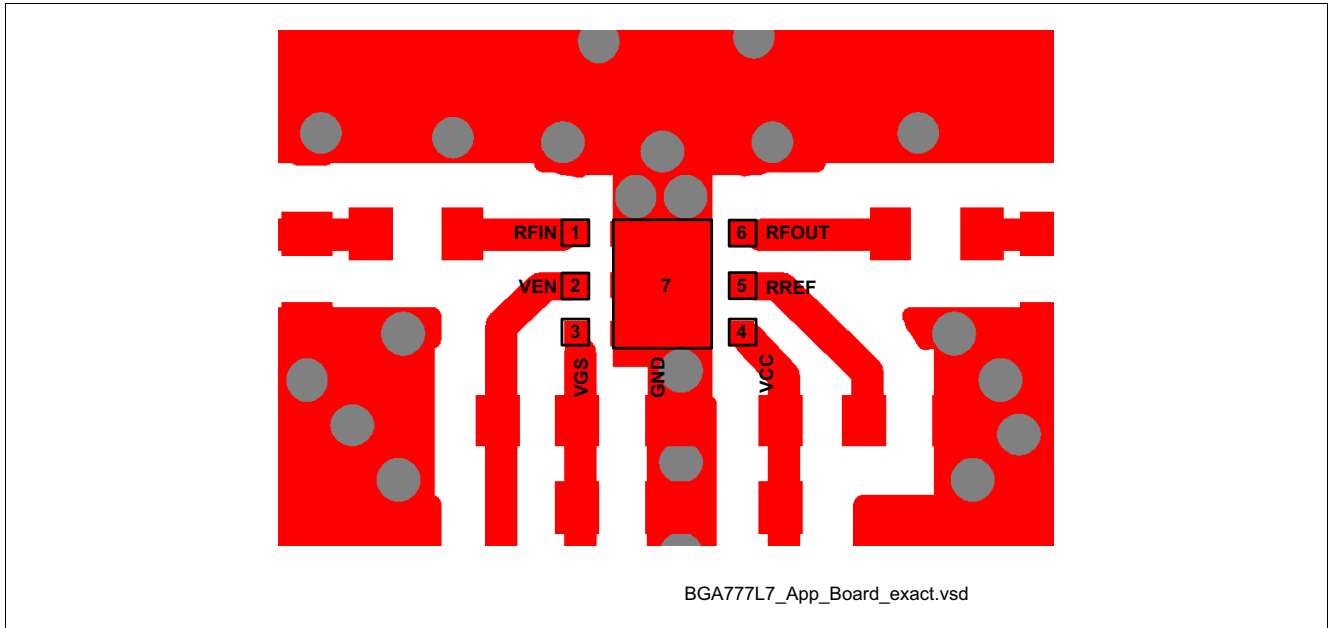

Figure 7 Detail of application board layout

Note: In order to achieve the same performance as given in this datasheet please follow the suggested PCB-layout as closely as possible. The position of the GND vias is critical for RF performance.

4 Physical Characteristics

4.1 Package Dimensions

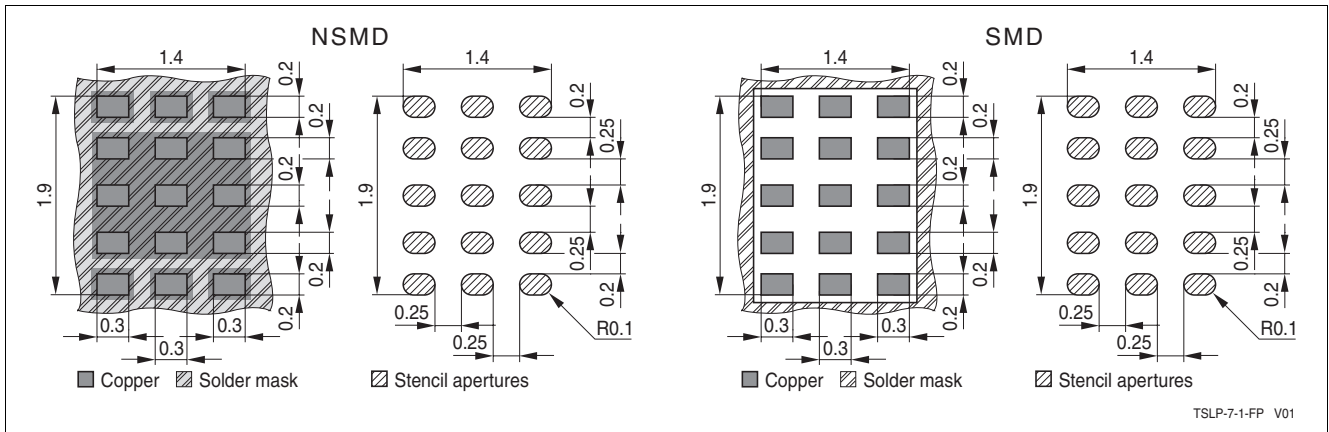

Figure 8 Recommended footprint and stencil layout for the TSLP-7-1 package

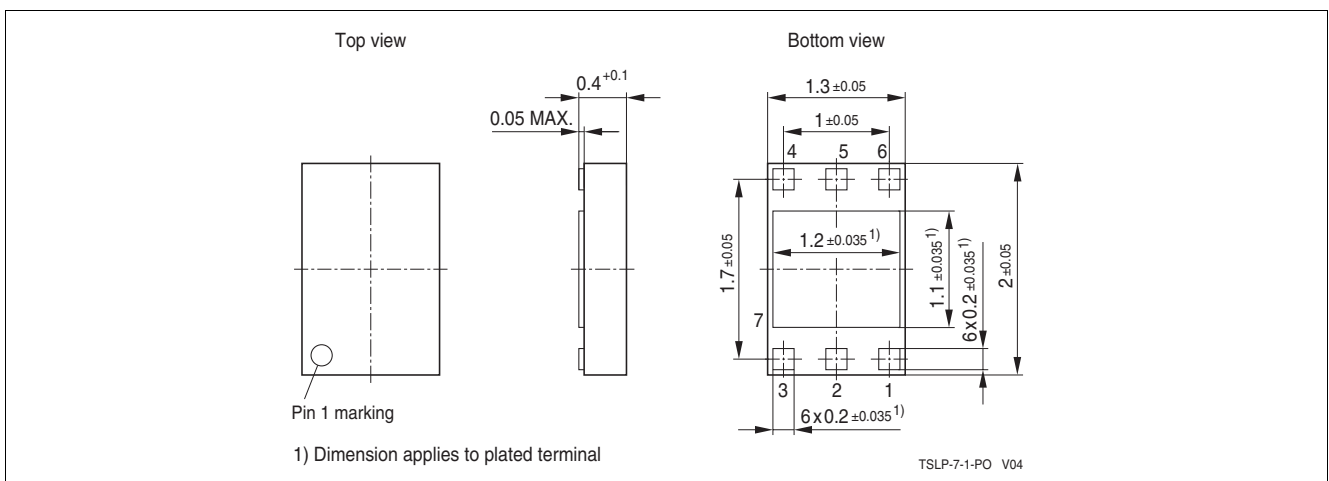

Figure 9 Package outline (top, side and bottom view)

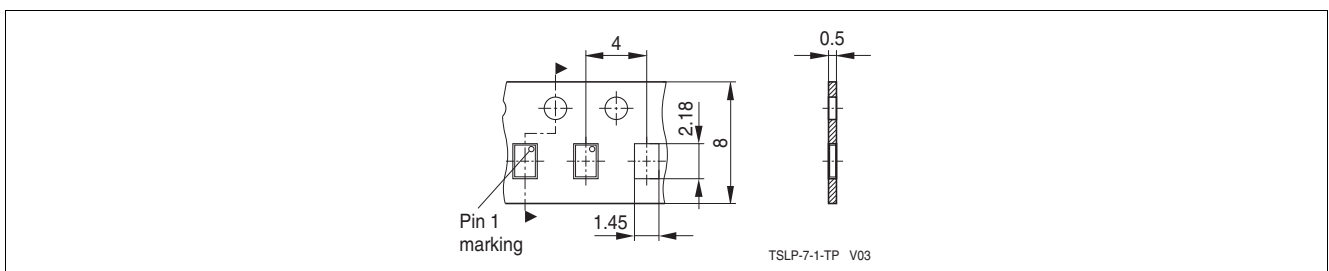

Figure 10 Tape & reel dimensions

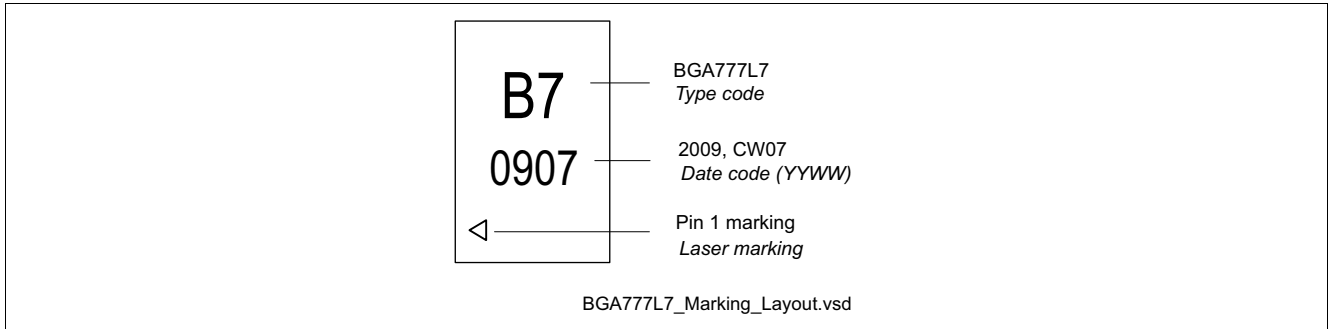

Figure 11 Marking layout

www.infineon.com

Published by Infineon Technologies AG

Mouser Electronics

Authorized Distributor

Click to View Pricing, Inventory, Delivery & Lifecycle Information:

[Infineon:](#)

[BGA 777L7 E6327](#)