

Micro-Power Voltage Detectors

General Description

The RT9819 is a micro-power voltage detector supervising the power supply voltage level for microprocessors (μ P) or digital systems. It provides internally fixed threshold levels with 0.1V per step ranging from 1.2V to 5V, which covers most digital applications. It features low supply current of 3 μ A. The RT9819 performs supervisory function by sending out a reset signal whenever the V_{DD} voltage falls below a preset threshold level. This reset signal will last the whole period before V_{DD} recovering. Once V_{DD} recovered upcrossing the threshold level, the reset signal will be released after a certain delay time. The RT9819 is provided in SC-70-3, SC-82, SOT-23-3 and WDFN-6L 1.6x1.6 packages.

Ordering Information

RT9819	□	□	□	□	□
	Package Type				
	U3 : SC-70-3				
	V : SOT-23-3				
	VL : SOT-23-3 (L-Type)				
	Y : SC-82				
	YR : SC-82 (R-Type)				
	QW : WDFN-6L 1.6x1.6 (W-Type)				
	Lead Plating System				
	P : Pb Free				
	G : Green (Halogen Free and Pb Free)				
	Threshold Voltage				
	12 : 1.2V				
	13 : 1.3V				
	:				
	49 : 4.9V				
	50 : 5.0V				
	Reset Active Timeout Period				
	A = 0ms ($\overline{\text{RESET}}$)				
	B = 55ms ($\overline{\text{RESET}}$)				
	C = 220ms ($\overline{\text{RESET}}$)				
	D = 450ms ($\overline{\text{RESET}}$)				
	E = 0ms (RESET)				
	F = 55ms (RESET)				
	G = 220ms (RESET)				
	H = 450ms (RESET)				

Note :

Richtek products are :

- ▶ RoHS compliant and compatible with the current requirements of IPC/JEDEC J-STD-020.
- ▶ Suitable for use in SnPb or Pb-free soldering processes.

Features

- Internally Fixed Threshold 1.2V to 5V in 0.1V Step
- High Accuracy $\pm 1.5\%$
- Low Supply Current 3 μ A
- No External Components Required
- Quick Reset within 20 μ s
- Built-in Recovery Delay Include 0ms, 55ms, 220ms, 450ms Options
- Low Functional Supply Voltage 0.9V
- CMOS Push-Pull Output
- Small SC-70-3, SC-82, SOT-23-3 and WDFN-6L 1.6x1.6 Packages
- RoHS Compliant and Halogen Free

Applications

- Computers
- Controllers
- Intelligent Instruments
- Critical μ P and μ C Power Monitoring
- Portable/Battery-Powered Equipment

Typical Application Circuit

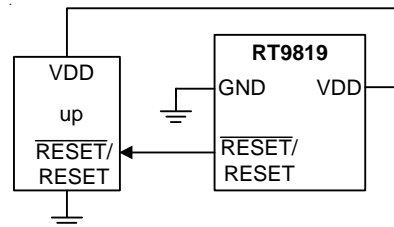

Marking Information

For marking information, contact our sales representative directly or through a Richtek distributor located in your area.

Pin Configurations

(TOP VIEW)

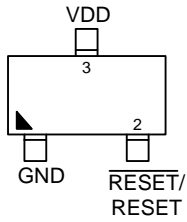

SC-70-3

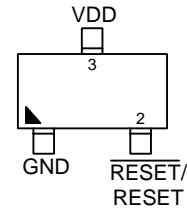

SOT-23-3

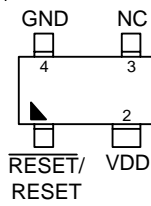

SC-82

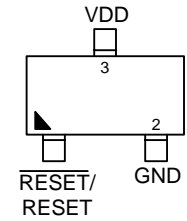

SOT-23-3 (L-Type)

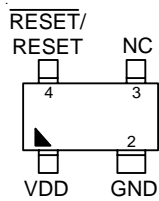

SC-82 (R-Type)

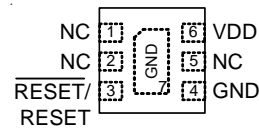

WDFN-6L 1.6x1.6

Functional Pin Description

Pin Name	Pin Function
GND	Ground.
$\overline{\text{RESET}}$	Active Low Push-Pull Reset Output.
RESET	Active High Push-Pull Reset Output
VDD	Power Input.
NC	No Internal Connection.

Function Block Diagram

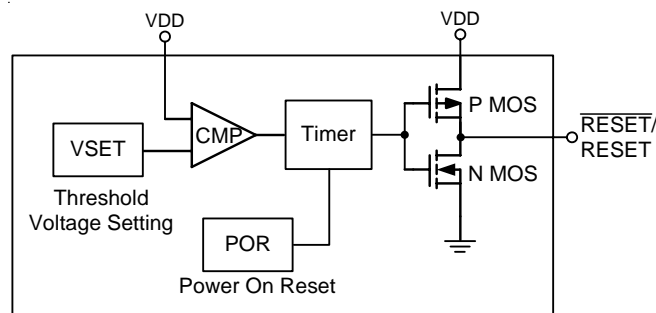

Absolute Maximum Ratings (Note 1)

- Terminal Voltage (with Respect to GND)
 - V_{DD} ----- -0.3V to 6V
- All Other Inputs ----- -0.3V to ($V_{DD} + 0.3V$)
- Input Current, I_{VDD} ----- 20mA
- Power Dissipation, PD @ $T_A = 25^{\circ}C$
 - SC-70-3/SC-82 ----- 0.25W
 - SOT-23-3 ----- 0.4W
 - WDFN-6L 1.6x1.6 ----- 1.7W
- Package Thermal Resistance (Note 2)
 - SC-70-3/SC-82, θ_{JA} ----- 400 $^{\circ}C/W$
 - SOT-23-3, θ_{JA} ----- 250 $^{\circ}C/W$
 - WDFN-6L 1.6x1.6, θ_{JA} ----- 58.5 $^{\circ}C/W$
- Lead Temperature (Soldering, 10sec.) ----- 260 $^{\circ}C$
- Storage Temperature Range ----- -65 $^{\circ}C$ to 125 $^{\circ}C$
- ESD Susceptibility (Note 3)
 - HBM (Human Body Model) ----- 2kV
 - MM (Machine Model) ----- 200V

Recommended Operating Conditions (Note 4)

- Junction Temperature Range ----- -40 $^{\circ}C$ to 125 $^{\circ}C$
- Ambient Temperature Range ----- -40 $^{\circ}C$ to 85 $^{\circ}C$

Electrical Characteristics

($V_{DD} = 3V$, $T_A = 25^{\circ}C$, unless otherwise specified)

Parameter	Symbol	Test Conditions	Min	Typ	Max	Unit	
Operating V_{DD} (V_{OUT}) Range	V_{DD}	RT9819A/B/C/D	0.9	--	6	V	
		RT9819E/F/G/H	1.1	--	6		
Supply Current	I_{DD}	$V_{TH} = 3V$, $V_{DD} = 4.5V$	--	3	8	μA	
Reset Threshold	V_{TH}		--	1.2 to 5	--	V	
Threshold Voltage Accuracy	ΔV_{TH}		-1.5	--	1.5	%	
Threshold Voltage Hysteresis	V_{HYS}		--	0.01 V_{TH}	--	V	
V_{DD} Drop to Reset Delay	t_{RD}	Drop = $V_{TH} - 125mV$	--	20	--	μs	
Reset Active Time Out Period	RT9819A/E	t_{RP}	$V_{DD} \geq 1.02 \times V_{TH}$	--	0	--	ms
	RT9819B/F			35	55	75	ms
	RT9819C/G			143	220	297	ms
	RT9819D/H			292	450	608	ms

Parameter	Symbol	Test Conditions	Min	Typ	Max	Unit
RESET Output Voltage Low	V _{OL}	V _{DD} < V _{TH(MIN)} , I _{SINK} = 3.5mA, V _{TH} ≥ 3V	--	--	0.4	V
		V _{DD} < V _{TH(MIN)} , I _{SINK} = 1.2mA, V _{TH} ≥ 1.8V	--	--	0.3	
		V _{TH(MIN)} > V _{DD} > 1V, I _{SINK} = 0.5mA	--	--	0.3	
RESET Output Voltage High	V _{OH}	V _{DD} > V _{TH(MAX)} , I _{SOURCE} = 800μA, V _{TH} ≥ 3V	V _{DD} - 1.5	--	--	V
		V _{DD} > V _{TH(MAX)} , I _{SOURCE} = 500μA, V _{TH} ≥ 1.8V	0.8 V _{DD}	--	--	
		V _{DD} > V _{TH(MAX)} , I _{SOURCE} = 200μA, V _{TH} ≥ 1.1V	0.8 V _{DD}	--	--	
RESET Output Voltage Low	V _{OL}	V _{DD} > V _{TH(MAX)} , I _{SINK} = 3.5mA, V _{TH} ≥ 3V	--	--	0.4	V
		V _{DD} > V _{TH(MAX)} , I _{SINK} = 1.2mA, V _{TH} ≥ 1.8V	--	--	0.3	
		V _{DD} > V _{TH(MAX)} , I _{SINK} = 0.5mA, V _{TH} ≥ 1.2V	--	--	0.3	
RESET Output Voltage High	V _{OH}	1.1V < V _{DD} < V _{TH(MIN)} , I _{SOURCE} = 200μA	0.8 V _{DD}	--	--	V
		1.8V < V _{DD} < V _{TH(MIN)} , I _{SOURCE} = 500μA	0.8 V _{DD}	--	--	
		3V < V _{DD} < V _{TH(MIN)} , I _{SOURCE} = 800μA	V _{DD} - 1.5	--	--	

Note 1. Stresses beyond those listed “Absolute Maximum Ratings” may cause permanent damage to the device. These are stress ratings only, and functional operation of the device at these or any other conditions beyond those indicated in the operational sections of the specifications is not implied. Exposure to absolute maximum rating conditions may affect device reliability.

Note 2. θ_{JA} is measured at T_A = 25°C on a single-layer and four-layer test board of JEDEC 51.

Note 3. Devices are ESD sensitive. Handling precaution is recommended.

Note 4. The device is not guaranteed to function outside its operating conditions.

Typical Operating Characteristics

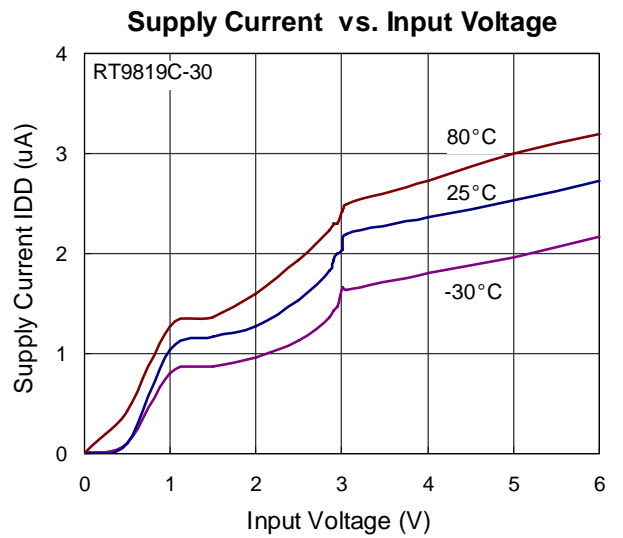
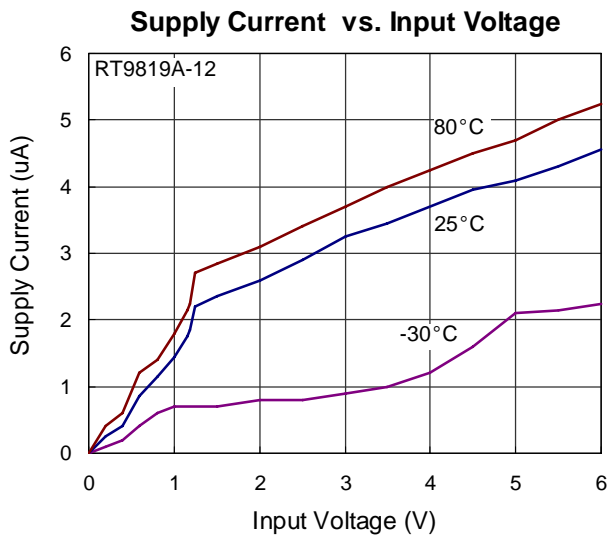
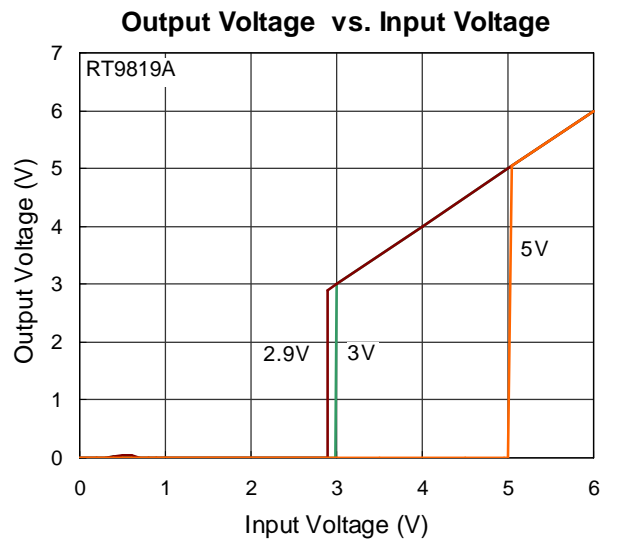
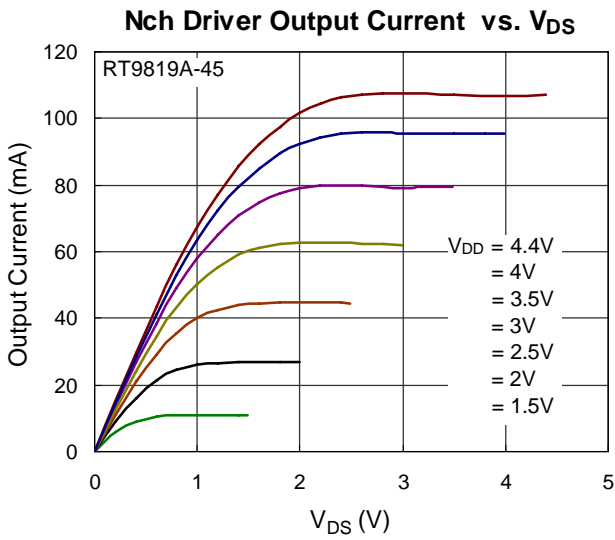
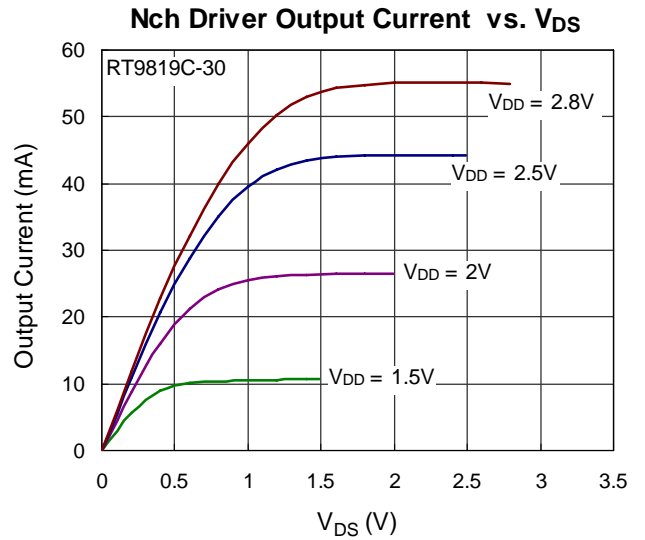
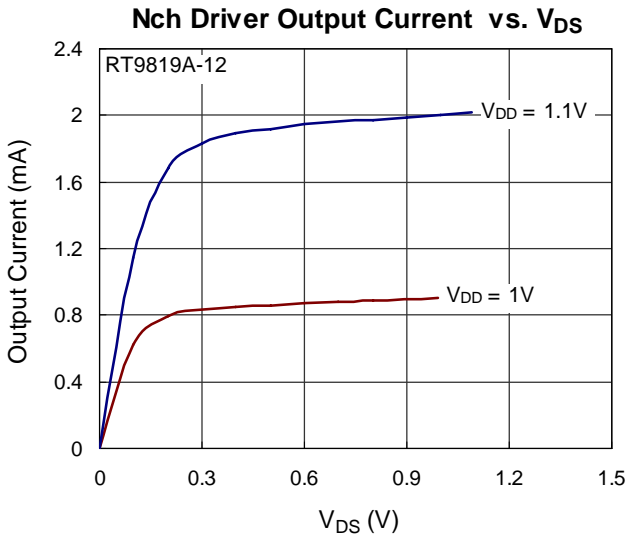

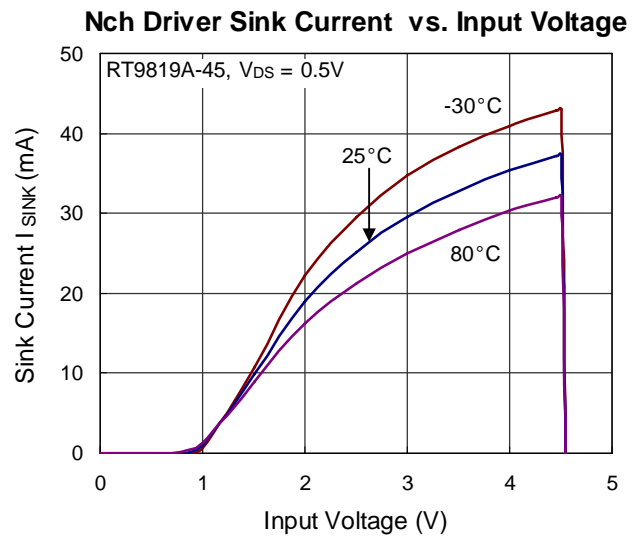
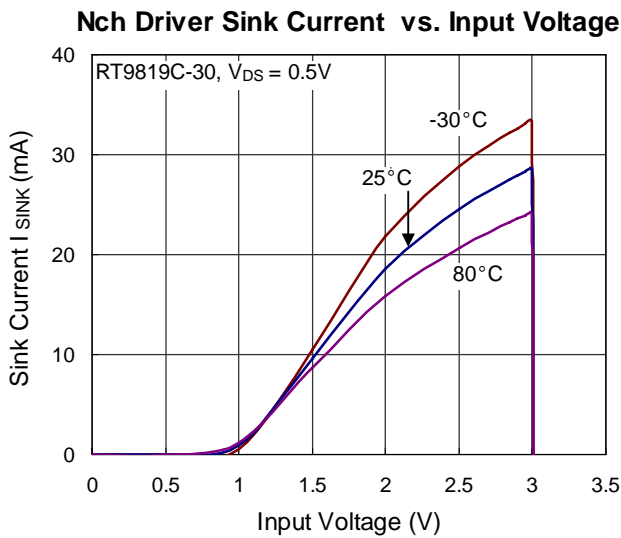
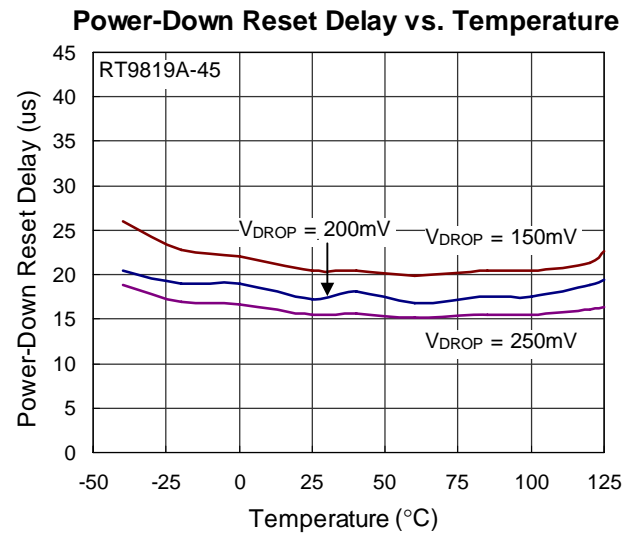
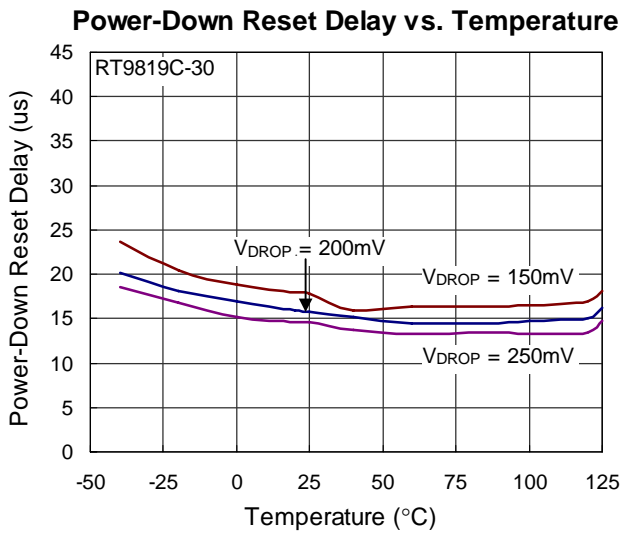
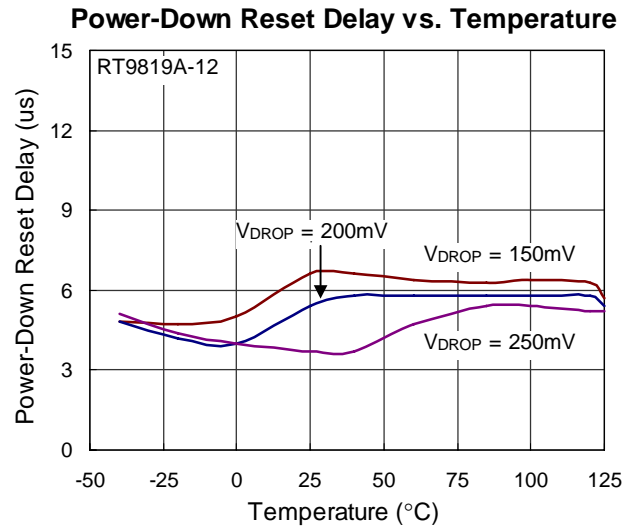
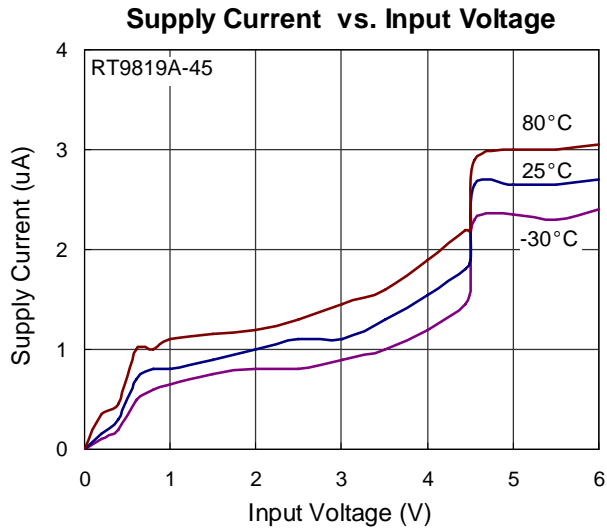

Reset Threshold Deviation vs. Temperature

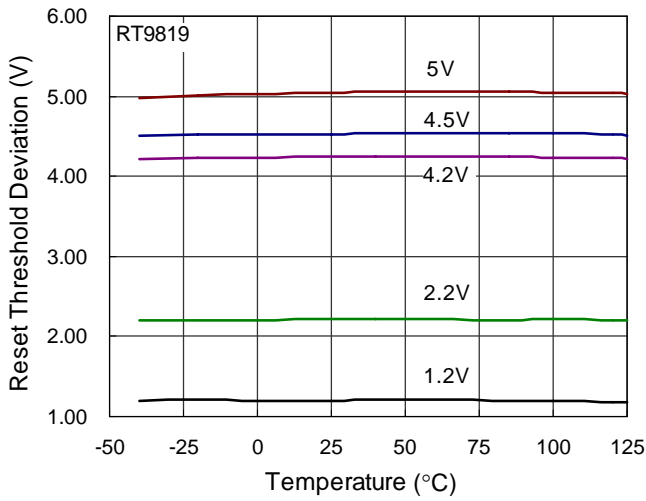

Pch Driver Output Current vs. Input Voltage

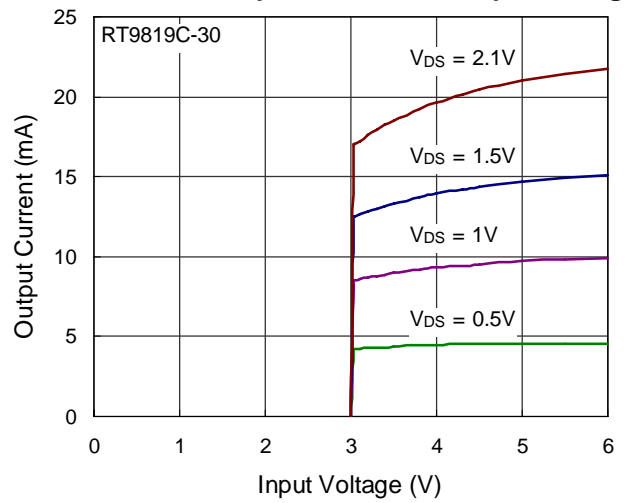

Power-Up Reset Time-Out vs. Temperature

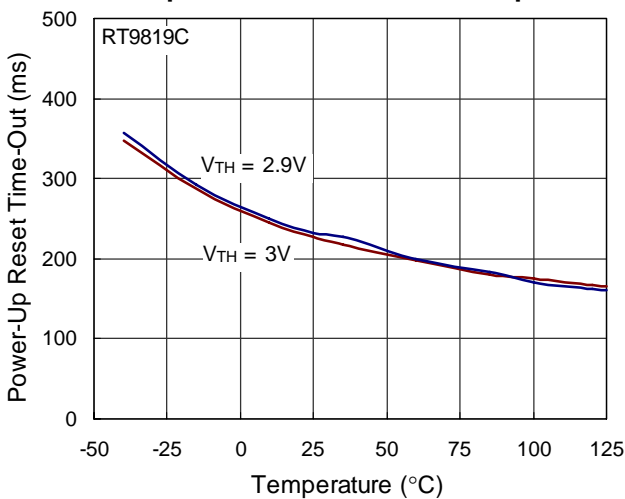

Power-Up Reset Time-Out vs. Temperature

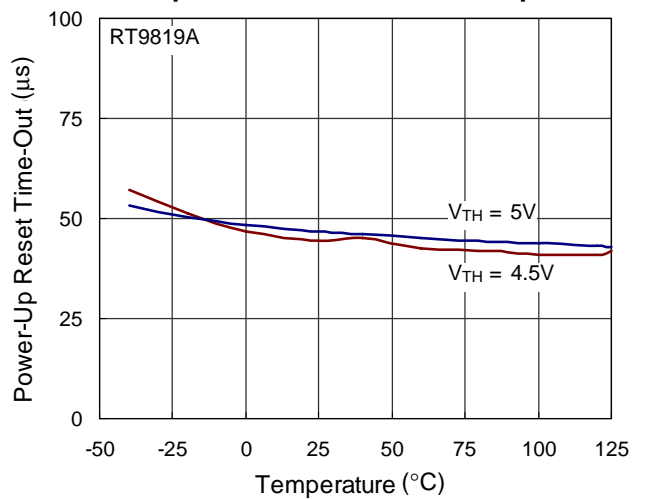

Output Delay Time vs. Load Capacitance

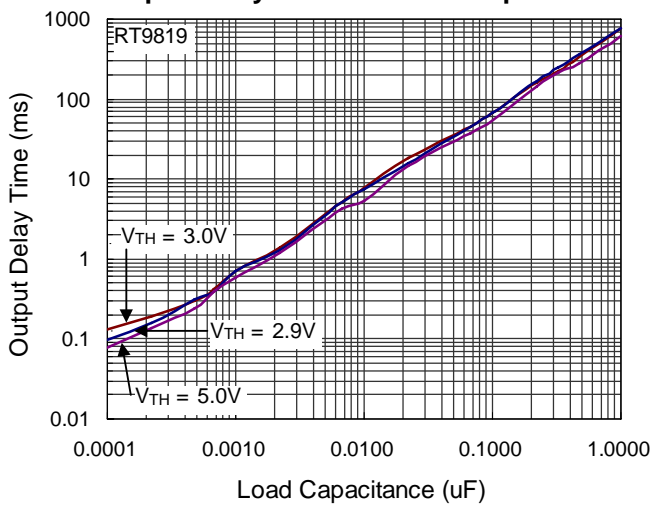

Nch Driver Output Current vs. V_{DS}

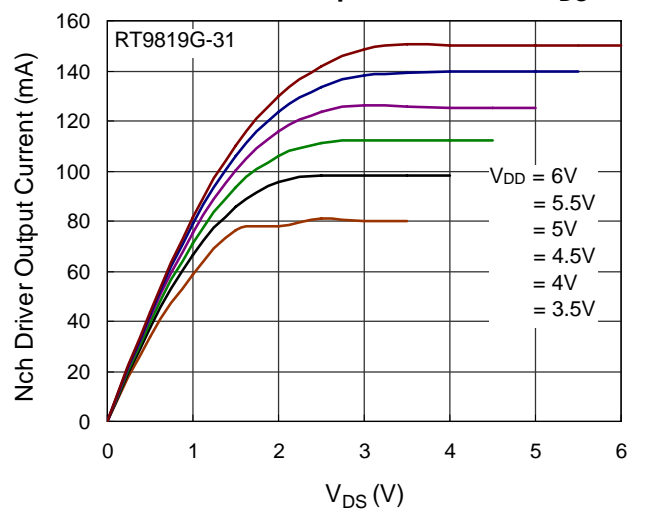

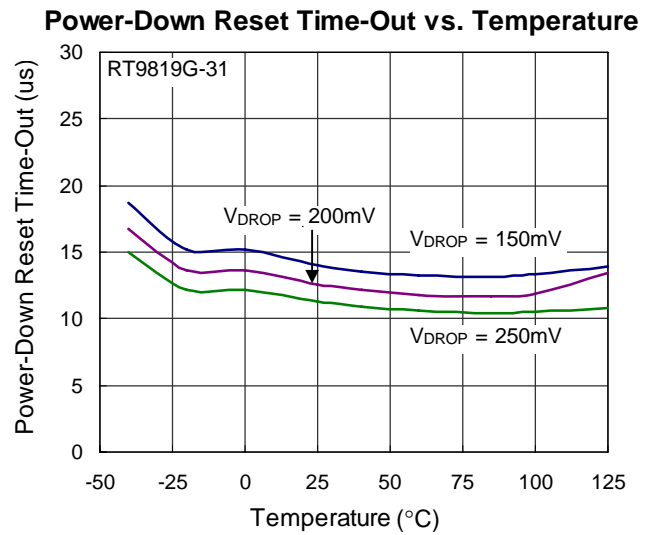
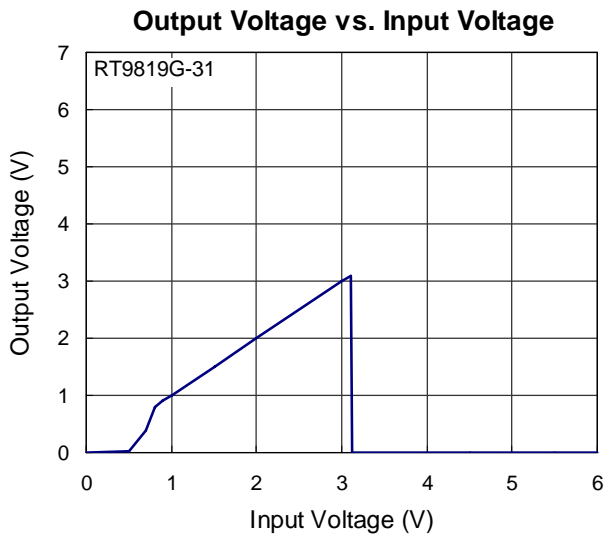
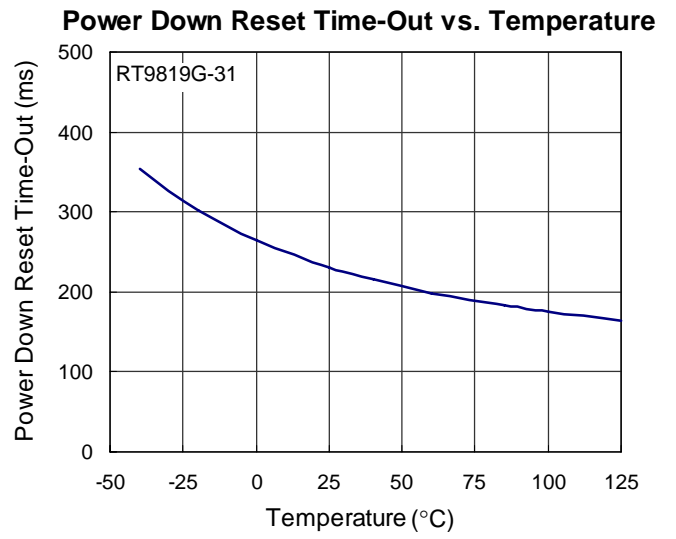
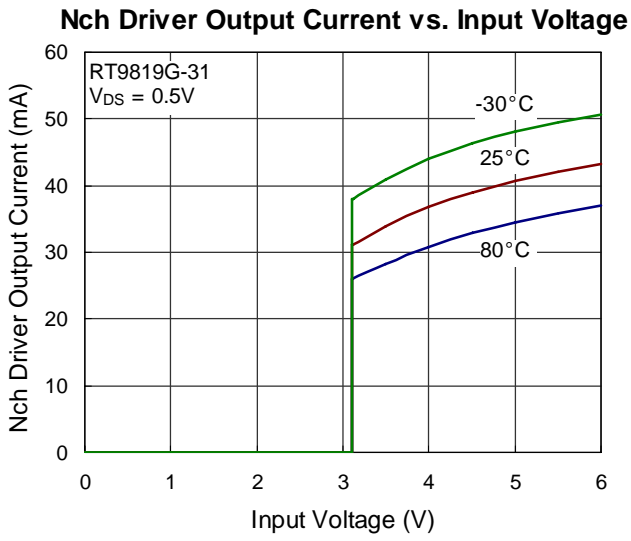

Application Information

Benefits of Highly Accurate Reset Threshold

Most μ P supervisor ICs have reset threshold voltages between 1% and 1.5% below the value of nominal supply voltages. This ensures a reset will not occur within 1% of the nominal supply, but will occur when the supply is 1.5% below nominal.

Outline Dimension

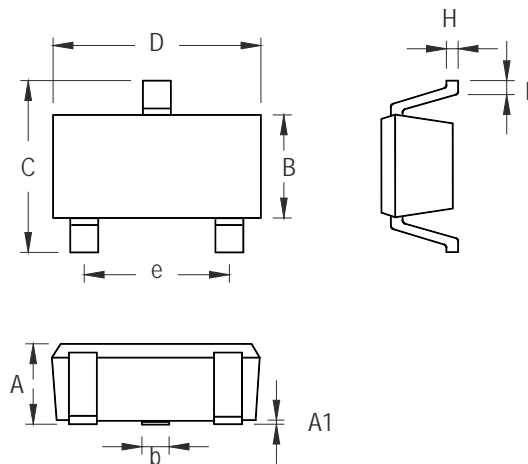

Symbol	Dimensions In Millimeters		Dimensions In Inches	
	Min	Max	Min	Max
A	0.800	1.100	0.031	0.044
A1	0.000	0.100	0.000	0.004
B	1.150	1.350	0.045	0.054
b	0.150	0.400	0.006	0.016
C	1.800	2.450	0.071	0.096
D	1.800	2.250	0.071	0.089
e	1.300		0.051	
H	0.080	0.260	0.003	0.010
L	0.210	0.460	0.008	0.018

SC-70-3 Surface Mount Package

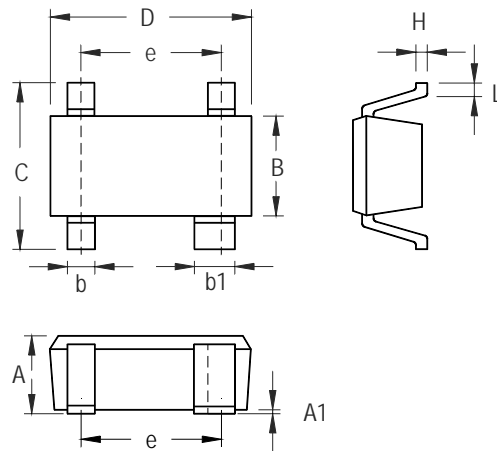

Symbol	Dimensions In Millimeters		Dimensions In Inches	
	Min	Max	Min	Max
A	0.800	1.100	0.031	0.043
A1	0.000	0.100	0.000	0.004
B	1.150	1.350	0.045	0.053
b	0.150	0.400	0.006	0.016
b1	0.350	0.500	0.014	0.020
C	1.800	2.450	0.071	0.096
D	1.800	2.200	0.071	0.087
e	1.300		0.051	
H	0.080	0.260	0.003	0.010
L	0.200	0.460	0.008	0.018

SC-82 Surface Mount Package

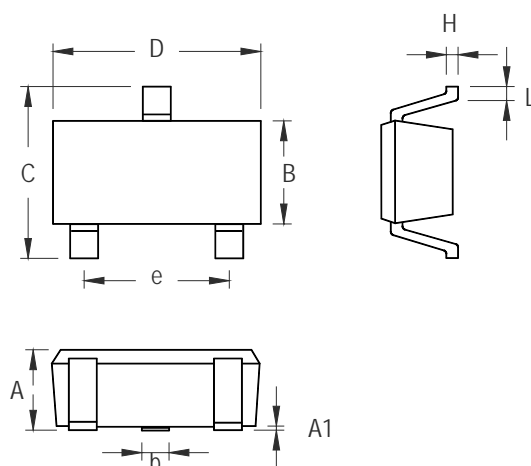

Symbol	Dimensions In Millimeters		Dimensions In Inches	
	Min	Max	Min	Max
A	0.889	1.295	0.035	0.051
A1	0.000	0.152	0.000	0.006
B	1.397	1.803	0.055	0.071
b	0.356	0.508	0.014	0.020
C	2.591	2.997	0.102	0.118
D	2.692	3.099	0.106	0.122
e	1.803	2.007	0.071	0.079
H	0.080	0.254	0.003	0.010
L	0.300	0.610	0.012	0.024

SOT-23-3 Surface Mount Package

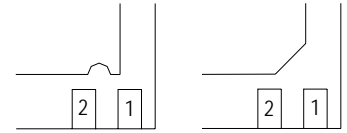
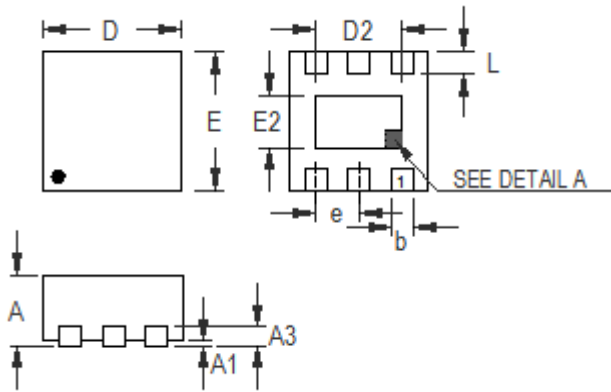

DETAILA

Pin #1 ID and Tie Bar Mark Options

Note : The configuration of the Pin #1 identifier is optional, but must be located within the zone indicated.

Symbol	Dimensions In Millimeters		Dimensions In Inches	
	Min	Max	Min	Max
A	0.700	0.800	0.028	0.031
A1	0.000	0.050	0.000	0.002
A3	0.175	0.250	0.007	0.010
b	0.200	0.300	0.008	0.012
D	1.550	1.650	0.061	0.065
D2	0.950	1.050	0.037	0.041
E	1.550	1.650	0.061	0.065
E2	0.550	0.650	0.022	0.026
e	0.500		0.020	
L	0.190	0.290	0.007	0.011

W-Type 6L DFN 1.6x1.6 Package

Richtek Technology Corporation

5F, No. 20, Taiyuen Street, Chupei City
 Hsinchu, Taiwan, R.O.C.
 Tel: (8863)5526789

Richtek products are sold by description only. Richtek reserves the right to change the circuitry and/or specifications without notice at any time. Customers should obtain the latest relevant information and data sheets before placing orders and should verify that such information is current and complete. Richtek cannot assume responsibility for use of any circuitry other than circuitry entirely embodied in a Richtek product. Information furnished by Richtek is believed to be accurate and reliable. However, no responsibility is assumed by Richtek or its subsidiaries for its use; nor for any infringements of patents or other rights of third parties which may result from its use. No license is granted by implication or otherwise under any patent or patent rights of Richtek or its subsidiaries.