

### FEATURES

- Fully differential
- Extremely low power with power-down feature
  - 2.6 mA quiescent supply current @ 5 V
  - 450  $\mu$ A in power-down mode @ 5 V
- High speed
  - 110 MHz large signal 3 dB bandwidth @  $G = 1$
  - 450 V/ $\mu$ s slew rate
- 12-bit SFDR performance @ 500 kHz
- Fast settling time: 100 ns to 0.02%
- Low input offset voltage:  $\pm 2.6$  mV max
- Low input offset current: 0.45  $\mu$ A max
- Differential input and output
- Differential-to-differential or single-ended-to-differential operation
- Rail-to-rail output
- Adjustable output common-mode voltage
- Externally adjustable gain
- Wide supply voltage range: 2.7 V to 12 V
- Available in small SOIC package
- Qualified for automotive applications

### APPLICATIONS

- ADC drivers
- Automotive vision and safety systems
- Automotive infotainment systems
- Portable instrumentation
- Battery-powered applications
- Single-ended-to-differential converters
- Differential active filters
- Video amplifiers
- Level shifters

### GENERAL DESCRIPTION

The AD8137 is a low cost differential driver with a rail-to-rail output that is ideal for driving ADCs in systems that are sensitive to power and cost. The AD8137 is easy to apply, and its internal common-mode feedback architecture allows its output common-mode voltage to be controlled by the voltage applied to one pin. The internal feedback loop also provides inherently balanced outputs as well as suppression of even-order harmonic distortion products. Fully differential and single-ended-to-differential gain configurations are easily realized by the AD8137. External feedback networks consisting of four resistors determine the

### FUNCTIONAL BLOCK DIAGRAM

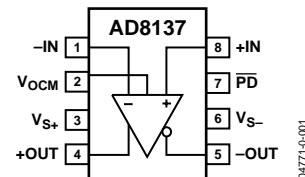

Figure 1.

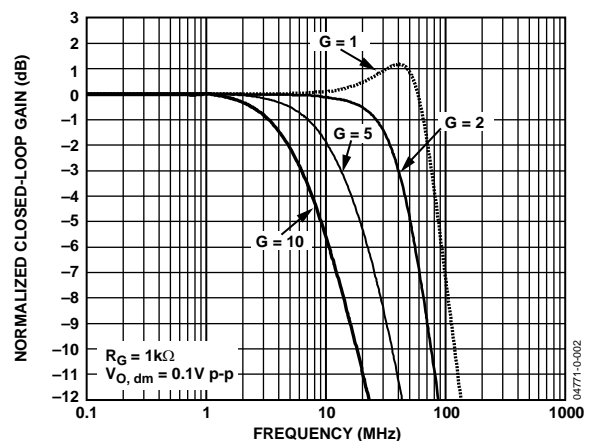

Figure 2. Small Signal Response for Various Gains

closed-loop gain of the amplifier. The power-down feature is beneficial in critical low power applications.

The AD8137 is manufactured on Analog Devices, Inc., proprietary second-generation XFCB process, enabling it to achieve high levels of performance with very low power consumption.

The AD8137 is available in the small 8-lead SOIC package and 3 mm  $\times$  3 mm LFCSP package. It is rated to operate over the extended industrial temperature range of  $-40^{\circ}\text{C}$  to  $+125^{\circ}\text{C}$ .

#### Rev. E

Information furnished by Analog Devices is believed to be accurate and reliable. However, no responsibility is assumed by Analog Devices for its use, nor for any infringements of patents or other rights of third parties that may result from its use. Specifications subject to change without notice. No license is granted by implication or otherwise under any patent or patent rights of Analog Devices. Trademarks and registered trademarks are the property of their respective owners.

# IMPORTANT LINKS for the [AD8137](#)\*

Last content update 10/24/2013 10:31 am

**NEWER ALTERNATIVES:** [ADA4940-1](#): (single) and [ADA4940-2](#): (dual): Ultralow Power, Low Distortion ADC Driver

## SIMILAR PRODUCTS & PARAMETRIC SELECTION TABLES

Find Similar Products By Operating Parameters

High Speed Amplifiers Selection Table

[ADA4932-1](#): (single) and [ADA4932-2](#): (dual): Low Cost / Low Power Differential ADC Driver

[ADA4937-1](#): (single) and [ADA4937-2](#): (dual): Ultralow Distortion Differential ADC Driver

[ADA4938-1](#): (single) and [ADA4938-2](#): (dual): Ultralow Distortion Differential ADC Driver

[ADA4927-1](#): (single) and [ADA4927-2](#): (dual): Ultralow Distortion Current Feedback Differential ADC Driver

[ADA4930-1](#): (single) and [ADA4930-2](#): (dual): Ultralow Noise Drivers for Low Voltage ADCs

## DESIGN TOOLS, MODELS, DRIVERS & SOFTWARE

Analog Filter Wizard 2.0

ADI DiffAmpCalc™

AD8137 SPICE Macro-Model, Rev D

## DESIGN COLLABORATION COMMUNITY



[Collaborate Online](#) with the ADI support team and other designers about select ADI products.

Follow us on Twitter: [www.twitter.com/ADI\\_News](http://www.twitter.com/ADI_News)

Like us on Facebook: [www.facebook.com/AnalogDevicesInc](http://www.facebook.com/AnalogDevicesInc)

## DOCUMENTATION

**AN-1026:** High Speed Differential ADC Driver Design Considerations

**AN-0990:** Terminating a Differential Amplifier in Single-Ended Input Applications

**AN-0992:** Active Filter Evaluation Board for Differential Amplifiers

**AN-649:** Using the Analog Devices Active Filter Design Tool

**AN-584:** Using the AD813X Differential Amplifier

**MT-218:** Multiple Feedback Band-Pass Design Example

**MT-076:** Differential Driver Analysis

**MT-075:** Differential Drivers for High Speed ADCs Overview

A Stress-Free Method for Choosing High-Speed Op Amps

**UG-474:** Evaluation Board for Differential Amplifiers Offered in 8-Lead SOIC Packages

**UG-190:** Differential Amplifier Evaluation Board for Single 8-lead LFCSP Packages

**UG-130:** Differential Amplifier Evaluation Board for 8-lead SOIC and MSOP Packages

"Rules of the Road" for High-Speed Differential ADC Drivers

AD8139/AD8137: Differential Amplifiers For ADC Driving

Industrial Applications Booklet

Industrial Applications Technical Presentation

## DESIGN SUPPORT

Submit your support request here:

[Linear and Data Converters](#)  
[Embedded Processing and DSP](#)

Telephone our Customer Interaction Centers toll free:

Americas:	1-800-262-5643
Europe:	00800-266-822-82
China:	4006-100-006
India:	1800-419-0108
Russia:	8-800-555-45-90

[Quality and Reliability](#)  
[Lead\(Pb\)-Free Data](#)

## SAMPLE & BUY

### AD8137

- View Price & Packaging
- Request Evaluation Board
- Request Samples
- Check Inventory & Purchase

[Find Local Distributors](#)

## EVALUATION KITS & SYMBOLS & FOOTPRINTS

View the Evaluation Boards and Kits page for documentation and purchasing

Symbols and Footprints

\* This page was dynamically generated by Analog Devices, Inc. and inserted into this data sheet.  
Note: Dynamic changes to the content on this page (labeled 'Important Links') does not constitute a change to the revision number of the product data sheet.  
This content may be frequently modified.

## TABLE OF CONTENTS

Features .....	1
Applications .....	1
Functional Block Diagram .....	1
General Descripton .....	1
Revision History .....	2
Specifications .....	3
Absolute Maximum Ratings .....	9
Thermal Resistance .....	9
Maximum Power Dissipation .....	9
ESD Caution .....	9
Pin Configuration and Function Descriptions .....	10
Typical Performance Characteristics .....	11

## REVISION HISTORY

### 7/12—Rev. D to Rev. E

Changes to Features Section and Applications Section .....	1
Added AD8137W .....	Universal
Updated Outline Dimensions .....	28
Changes to Ordering Guide .....	29
Added Automotive Products Section .....	29

### 7/10—Rev. C to Rev. D

Changes to Power-Down Section, Added Figure 68, Renumbered Subsequent Figures .....	24
Changes to Ordering Guide .....	27

### 12/09—Rev. B to Rev. C

Changes to Product Title, Applications Section, and General Description Section .....	1
Changes to Input Resistance Parameter Unit, Table 3 .....	5
Added EPAD Mnemonic/Description, Table 6 .....	7
Added Figure 61; Renumbered Sequentially .....	17
Moved Test Circuits Section .....	18
Changes to Power Down Section .....	24
Updated Outline Dimensions .....	26

### 7/05—Rev. A to Rev. B

Changes to Ordering Guide .....	24
---------------------------------	----

Test Circuits .....	21
Theory of Operation .....	22
Applications Information .....	23
Analyzing a Typical Application with Matched $R_F$ and $R_G$ Networks .....	23
Estimating Noise, Gain, and Bandwidth with Matched Feedback Networks .....	23
Driving an ADC with Greater than 12-Bit Performance .....	27
Outline Dimensions .....	29
Ordering Guide .....	30
Automotive Products .....	30

### 8/04—Rev. 0 to Rev. A.

Added 8-Lead LFCSP .....	Universal
Changes to Layout .....	Universal
Changes to Product Title and Figure 1 .....	1
Changes to Specifications .....	3
Changes to Absolute Maximum Ratings .....	6
Changes to Figure 4 and Figure 5 .....	7
Added Figure 6, Figure 20, Figure 23, Figure 35, Figure 48, and Figure 58; Renumbered Sequentially .....	7
Changes to Figure 32 .....	12
Changes to Figure 40 .....	13
Changes to Figure 55 .....	16
Changes to Table 7 and Figure 63 .....	18
Changes to Equation 19 .....	19
Changes to Figure 64 and Figure 65 .....	20
Changes to Figure 66 .....	22
Added Driving an ADC with Greater Than 12-Bit Performance Section .....	22
Changes to Ordering Guide .....	24
Updated Outline Dimensions .....	24

### 5/04—Revision 0: Initial Version

## SPECIFICATIONS

$V_S = \pm 5\text{ V}$ ,  $V_{OCM} = 0\text{ V}$  (@  $25^\circ\text{C}$ , differential gain = 1,  $R_{L, dm} = R_F = R_G = 1\text{ k}\Omega$ , unless otherwise noted,  $T_{MIN}$  to  $T_{MAX} = -40^\circ\text{C}$  to  $+125^\circ\text{C}$ ).

Table 1.

Parameter	Conditions	Min	Typ	Max	Unit
<b>DIFFERENTIAL INPUT PERFORMANCE</b>					
Dynamic Performance					
–3 dB Small Signal Bandwidth	$V_{O, dm} = 0.1\text{ V p-p}$	64	76		MHz
	AD8137W only: $T_{MIN}$ - $T_{MAX}$	63			MHz
–3 dB Large Signal Bandwidth	$V_{O, dm} = 2\text{ V p-p}$	79	110		MHz
	AD8137W only: $T_{MIN}$ - $T_{MAX}$	79			MHz
Slew Rate	$V_{O, dm} = 2\text{ V step}$		450		V/ $\mu\text{s}$
Settling Time to 0.02%	$V_{O, dm} = 3.5\text{ V step}$		100		Ns
Overdrive Recovery Time	$G = 2$ , $V_{l, dm} = 12\text{ V p-p triangle wave}$		85		Ns
Noise/Harmonic Performance					
SFDR	$V_{O, dm} = 2\text{ V p-p}$ , $f_c = 500\text{ kHz}$		90		dB
	$V_{O, dm} = 2\text{ V p-p}$ , $f_c = 2\text{ MHz}$		76		dB
Input Voltage Noise	$f = 50\text{ kHz to }1\text{ MHz}$		8.25		nV/ $\sqrt{\text{Hz}}$
Input Current Noise	$f = 50\text{ kHz to }1\text{ MHz}$		1		pA/ $\sqrt{\text{Hz}}$
DC Performance					
Input Offset Voltage	$V_{IP} = V_{IN} = V_{OCM} = 0\text{ V}$	–2.6	$\pm 0.7$	+2.6	mV
	AD8137W only: $T_{MIN}$ - $T_{MAX}$	–5.0		+5.0	mV
Input Offset Voltage Drift	$T_{MIN}$ to $T_{MAX}$		3		$\mu\text{V}/^\circ\text{C}$
Input Bias Current	$T_{MIN}$ to $T_{MAX}$		0.5	1.0	$\mu\text{A}$
Input Offset Current			0.1	0.45	$\mu\text{A}$
	AD8137W only: $T_{MIN}$ - $T_{MAX}$			0.45	$\mu\text{A}$
Open-Loop Gain			91		dB
Input Characteristics					
Input Common-Mode Voltage Range		–4		+4	V
	AD8137W only: $T_{MIN}$ - $T_{MAX}$	–4		+4	V
Input Resistance	Differential		800		k $\Omega$
	Common-mode		400		k $\Omega$
Input Capacitance	Common-mode		1.8		pF
CMRR	$\Delta V_{ICM} = \pm 1\text{ V}$	66	79		dB
	AD8137W only: $T_{MIN}$ - $T_{MAX}$	66			dB
Output Characteristics					
Output Voltage Swing	Each single-ended output, $R_{L, dm} = 1\text{ k}\Omega$	$V_{S-} + 0.55$		$V_{S+} - 0.55$	V
	AD8137W only: $T_{MIN}$ - $T_{MAX}$	$V_{S-} + 0.55$		$V_{S+} - 0.55$	V
Output Current			20		mA
Output Balance Error	$f = 1\text{ MHz}$		–64		dB
<b><math>V_{OCM}</math> to <math>V_{O, cm}</math> PERFORMANCE</b>					
$V_{OCM}$ Dynamic Performance					
–3 dB Bandwidth	$V_{O, cm} = 0.1\text{ V p-p}$		58		MHz
Slew Rate	$V_{O, cm} = 0.5\text{ V p-p}$		63		V/ $\mu\text{s}$
Gain		0.992	1.000	1.008	V/V
	AD8137W only: $T_{MIN}$ - $T_{MAX}$	0.990		1.008	V/V
$V_{OCM}$ Input Characteristics					
Input Voltage Range		–4		+4	V
	AD8137W only: $T_{MIN}$ - $T_{MAX}$	–4		+4	V
Input Resistance			35		k $\Omega$
Input Offset Voltage		–28	$\pm 11$	+28	mV
	AD8137W only: $T_{MIN}$ - $T_{MAX}$	–28		+28	mV
Input Voltage Noise	$f = 100\text{ kHz to }1\text{ MHz}$		18		nV/ $\sqrt{\text{Hz}}$

Parameter	Conditions	Min	Typ	Max	Unit
Input Bias Current	AD8137W only: $T_{MIN}-T_{MAX}$		0.3	1.1	$\mu A$
CMRR	$\Delta V_{O, dm}/\Delta V_{OCM}$ , $\Delta V_{OCM} = \pm 0.5 V$ AD8137W only: $T_{MIN}-T_{MAX}$	62	75	1.1	$\mu A$ dB dB
Power Supply					
Operating Range	AD8137W only: $T_{MIN}-T_{MAX}$	+2.7		$\pm 6$	V
Quiescent Current		+2.7	3.2	$\pm 6$	V mA
Quiescent Current, Disabled	AD8137W only: $T_{MIN}-T_{MAX}$ Power-down = low		750	3.60 3.65	mA $\mu A$
PSRR	AD8137W only: $T_{MIN}-T_{MAX}$ $\Delta V_S = \pm 1 V$	79	91	900	$\mu A$ dB
$\overline{PD}$ Pin	AD8137W only: $T_{MIN}-T_{MAX}$	79			dB
Threshold Voltage		$V_{S-} + 0.7$		$V_{S-} + 1.7$	V
Input Current	AD8137W only: $T_{MIN}-T_{MAX}$ Power-down = high/low AD8137W only: $T_{MIN}-T_{MAX}$	$V_{S-} + 0.7$	150/210	$V_{S-} + 1.7$ 170/240 180/245	V $\mu A$ $\mu A$
OPERATING TEMPERATURE RANGE		-40		+125	$^{\circ}C$

$V_S = 5\text{ V}$ ,  $V_{OCM} = 2.5\text{ V}$  (@  $25^\circ\text{C}$ , differential gain = 1,  $R_{L, dm} = R_F = R_G = 1\text{ k}\Omega$ , unless otherwise noted,  $T_{MIN}$  to  $T_{MAX} = -40^\circ\text{C}$  to  $+125^\circ\text{C}$ ).

Table 2.

Parameter	Conditions	Min	Typ	Max	Unit
<b>DIFFERENTIAL INPUT PERFORMANCE</b>					
Dynamic Performance					
–3 dB Small Signal Bandwidth	$V_{O, dm} = 0.1\text{ V p-p}$	63	75		MHz
	AD8137W only: $T_{MIN}$ – $T_{MAX}$	61			MHz
–3 dB Large Signal Bandwidth	$V_{O, dm} = 2\text{ V p-p}$	76	107		MHz
	AD8137W only: $T_{MIN}$ – $T_{MAX}$	76			MHz
Slew Rate	$V_{O, dm} = 2\text{ V step}$		375		V/ $\mu\text{s}$
Settling Time to 0.02%	$V_{O, dm} = 3.5\text{ V step}$		110		ns
Overdrive Recovery Time	$G = 2$ , $V_{i, dm} = 7\text{ V p-p triangle wave}$		90		ns
Noise/Harmonic Performance					
SFDR	$V_{O, dm} = 2\text{ V p-p}$ , $f_c = 500\text{ kHz}$		89		dB
	$V_{O, dm} = 2\text{ V p-p}$ , $f_c = 2\text{ MHz}$		73		dB
Input Voltage Noise	$f = 50\text{ kHz to }1\text{ MHz}$		8.25		nV/ $\sqrt{\text{Hz}}$
Input Current Noise	$f = 50\text{ kHz to }1\text{ MHz}$		1		pA/ $\sqrt{\text{Hz}}$
DC Performance					
Input Offset Voltage	$V_{IP} = V_{IN} = V_{OCM} = 0\text{ V}$	–2.7	$\pm 0.7$	+2.7	mV
	AD8137W only: $T_{MIN}$ – $T_{MAX}$	–5.0		+5.0	mV
Input Offset Voltage Drift	$T_{MIN}$ to $T_{MAX}$		3		$\mu\text{V}/^\circ\text{C}$
Input Bias Current	$T_{MIN}$ to $T_{MAX}$		0.5	0.9	$\mu\text{A}$
Input Offset Current			0.1	0.45	$\mu\text{A}$
	AD8137W only: $T_{MIN}$ – $T_{MAX}$			0.45	$\mu\text{A}$
Open-Loop Gain			89		dB
Input Characteristics					
Input Common-Mode Voltage Range		1		4	V
	AD8137W only: $T_{MIN}$ – $T_{MAX}$	1		4	V
Input Resistance	Differential		800		k $\Omega$
	Common-mode		400		k $\Omega$
Input Capacitance	Common-mode		1.8		pF
CMRR	$\Delta V_{ICM} = \pm 1\text{ V}$	64	90		dB
	AD8137W only: $T_{MIN}$ – $T_{MAX}$	64			dB
Output Characteristics					
Output Voltage Swing	Each single-ended output, $R_{L, dm} = 1\text{ k}\Omega$	$V_{S-} + 0.45$		$V_{S+} - 0.45$	V
	AD8137W only: $T_{MIN}$ – $T_{MAX}$	$V_{S-} + 0.45$		$V_{S+} - 0.45$	V
Output Current			20		mA
Output Balance Error	$f = 1\text{ MHz}$		–64		dB
<b><math>V_{OCM}</math> to <math>V_{O, cm}</math> PERFORMANCE</b>					
$V_{OCM}$ Dynamic Performance					
–3 dB Bandwidth	$V_{O, cm} = 0.1\text{ V p-p}$		60		MHz
Slew Rate	$V_{O, cm} = 0.5\text{ V p-p}$		61		V/ $\mu\text{s}$
Gain		0.980	1.000	1.020	V/V
	AD8137W only: $T_{MIN}$ – $T_{MAX}$	0.975		1.020	V/V
$V_{OCM}$ Input Characteristics					
Input Voltage Range		1		4	V
	AD8137W only: $T_{MIN}$ – $T_{MAX}$	1		4	V
Input Resistance			35		k $\Omega$
Input Offset Voltage		–25	$\pm 7.5$	+25	mV
	AD8137W only: $T_{MIN}$ – $T_{MAX}$	–25		+25	mV

Parameter	Conditions	Min	Typ	Max	Unit
Input Voltage Noise	f = 100 kHz to 5 MHz		18		nV/ $\sqrt{\text{Hz}}$
Input Bias Current			0.25	0.9	$\mu\text{A}$
CMRR	AD8137W only: $T_{\text{MIN}}-T_{\text{MAX}}$ $\Delta V_{\text{O,dm}} / \Delta V_{\text{OCM}}, \Delta V_{\text{OCM}} = \pm 0.5 \text{ V}$	62	75	0.9	$\mu\text{A}$
	AD8137W only: $T_{\text{MIN}}-T_{\text{MAX}}$	62			dB
Power Supply					
Operating Range		+2.7		$\pm 6$	V
Quiescent Current	AD8137W only: $T_{\text{MIN}}-T_{\text{MAX}}$	+2.7		$\pm 6$	V
			2.6	2.8	mA
Quiescent Current, Disabled	AD8137W only: $T_{\text{MIN}}-T_{\text{MAX}}$ Power-down = low		450	600	$\mu\text{A}$
	AD8137W only: $T_{\text{MIN}}-T_{\text{MAX}}$ Power-down = high			600	$\mu\text{A}$
PSRR	AD8137W only: $T_{\text{MIN}}-T_{\text{MAX}}$ $\Delta V_{\text{S}} = \pm 1 \text{ V}$	79	91		dB
	AD8137W only: $T_{\text{MIN}}-T_{\text{MAX}}$	79			dB
$\overline{\text{PD}}$ Pin					
Threshold Voltage		$V_{\text{S-}} + 0.7$		$V_{\text{S-}} + 1.5$	V
Input Current	AD8137W only: $T_{\text{MIN}}-T_{\text{MAX}}$ Power-down = high/low	$V_{\text{S-}} + 0.7$		$V_{\text{S-}} + 1.5$	V
	AD8137W only: $T_{\text{MIN}}-T_{\text{MAX}}$ Power-down = high		50/110	60/120	$\mu\text{A}$
	AD8137W only: $T_{\text{MIN}}-T_{\text{MAX}}$ Power-down = low			60/125	$\mu\text{A}$
OPERATING TEMPERATURE RANGE		-40		+125	$^{\circ}\text{C}$

$V_S = 3\text{ V}$ ,  $V_{OCM} = 1.5\text{ V}$  (@  $25^\circ\text{C}$ , differential gain = 1,  $R_{L, dm} = R_F = R_G = 1\text{ k}\Omega$ , unless otherwise noted,  $T_{MIN}$  to  $T_{MAX} = -40^\circ\text{C}$  to  $+125^\circ\text{C}$ ).

Table 3.

Parameter	Conditions	Min	Typ	Max	Unit
<b>DIFFERENTIAL INPUT PERFORMANCE</b>					
Dynamic Performance					
–3 dB Small Signal Bandwidth	$V_{O, dm} = 0.1\text{ V p-p}$	61	73		MHz
	AD8137W only: $T_{MIN}$ - $T_{MAX}$	58			MHz
–3 dB Large Signal Bandwidth	$V_{O, dm} = 2\text{ V p-p}$	62	93		MHz
	AD8137W only: $T_{MIN}$ - $T_{MAX}$	62			MHz
Slew Rate	$V_{O, dm} = 2\text{ V step}$		340		V/ $\mu\text{s}$
Settling Time to 0.02%	$V_{O, dm} = 3.5\text{ V step}$		110		Ns
Overdrive Recovery Time	$G = 2$ , $V_{l, dm} = 5\text{ V p-p triangle wave}$		100		Ns
Noise/Harmonic Performance					
SFDR	$V_{O, dm} = 2\text{ V p-p}$ , $f_c = 500\text{ kHz}$		89		dB
	$V_{O, dm} = 2\text{ V p-p}$ , $f_c = 2\text{ MHz}$		71		dB
Input Voltage Noise	$f = 50\text{ kHz to }1\text{ MHz}$		8.25		nV/ $\sqrt{\text{Hz}}$
Input Current Noise	$f = 50\text{ kHz to }1\text{ MHz}$		1		pA/ $\sqrt{\text{Hz}}$
<b>DC Performance</b>					
Input Offset Voltage	$V_{IP} = V_{IN} = V_{OCM} = 0\text{ V}$	–2.75	$\pm 0.7$	+2.75	mV
	AD8137W only: $T_{MIN}$ - $T_{MAX}$	–5.25		+5.25	mV
Input Offset Voltage Drift	$T_{MIN}$ to $T_{MAX}$		3		$\mu\text{V}/^\circ\text{C}$
Input Bias Current	$T_{MIN}$ to $T_{MAX}$		0.5	0.9	$\mu\text{A}$
Input Offset Current			0.1	0.4	$\mu\text{A}$
	AD8137W only: $T_{MIN}$ - $T_{MAX}$			0.4	$\mu\text{A}$
Open-Loop Gain			87		dB
<b>Input Characteristics</b>					
Input Common-Mode Voltage Range		1		2	V
	AD8137W only: $T_{MIN}$ - $T_{MAX}$	1		2	V
Input Resistance	Differential		800		k $\Omega$
	Common-mode		400		k $\Omega$
Input Capacitance	Common-mode		1.8		pF
CMRR	$\Delta V_{ICM} = \pm 1\text{ V}$	64	80		dB
	AD8137W only: $T_{MIN}$ - $T_{MAX}$	64			dB
<b>Output Characteristics</b>					
Output Voltage Swing	Each single-ended output, $R_{L, dm} = 1\text{ k}\Omega$	$V_{S-} + 0.37$		$V_{S+} - 0.37$	V
	AD8137W only: $T_{MIN}$ - $T_{MAX}$	$V_{S-} + 0.37$		$V_{S+} - 0.37$	V
Output Current			20		mA
Output Balance Error	$f = 1\text{ MHz}$		–64		dB
<b><math>V_{OCM}</math> to <math>V_{O, cm}</math> PERFORMANCE</b>					
$V_{OCM}$ Dynamic Performance					
–3 dB Bandwidth	$V_{O, cm} = 0.1\text{ V p-p}$		61		MHz
Slew Rate	$V_{O, cm} = 0.5\text{ V p-p}$		59		V/ $\mu\text{s}$
Gain		0.960	1.00	1.040	V/V
	AD8137W only: $T_{MIN}$ - $T_{MAX}$	0.955		1.040	V/V
$V_{OCM}$ Input Characteristics					
Input Voltage Range		1.0		2.0	V
	AD8137W only: $T_{MIN}$ - $T_{MAX}$	1.0		2.0	V
Input Resistance			35		k $\Omega$
Input Offset Voltage		–25	$\pm 5.5$	+25	mV
	AD8137W only: $T_{MIN}$ - $T_{MAX}$	–25		+25	mV
Input Voltage Noise	$f = 100\text{ kHz to }5\text{ MHz}$		18		nV/ $\sqrt{\text{Hz}}$
Input Bias Current			0.3	0.7	$\mu\text{A}$
	AD8137W only: $T_{MIN}$ - $T_{MAX}$			0.7	$\mu\text{A}$



Parameter	Conditions	Min	Typ	Max	Unit
CMRR	$\Delta V_{O, dm} / \Delta V_{OCM}, \Delta V_{OCM} = \pm 0.5 \text{ V}$	62	74		dB
	AD8137W only: $T_{MIN}-T_{MAX}$	62			dB
Power Supply					
Operating Range		+2.7		$\pm 6$	V
Quiescent Current	AD8137W only: $T_{MIN}-T_{MAX}$	+2.7		$\pm 6$	V
Quiescent Current, Disabled	AD8137W only: $T_{MIN}-T_{MAX}$		2.3	2.5	mA
PSRR	AD8137W only: $T_{MIN}-T_{MAX}$			2.5	mA
$\overline{\text{PD}}$ Pin	Power-down = low		345	460	$\mu\text{A}$
Threshold Voltage	AD8137W only: $T_{MIN}-T_{MAX}$			460	$\mu\text{A}$
Input Current	$\Delta V_S = \pm 1 \text{ V}$	78	90		dB
	AD8137W only: $T_{MIN}-T_{MAX}$	78			dB
		$V_{S-} + 0.7$		$V_{S-} + 1.5$	V
	AD8137W only: $T_{MIN}-T_{MAX}$	$V_{S-} + 0.7$		$V_{S-} + 1.5$	V
	Power-down = high/low		8/65	10/70	$\mu\text{A}$
	AD8137W only: $T_{MIN}-T_{MAX}$			10/75	$\mu\text{A}$
OPERATING TEMPERATURE RANGE		-40		+125	$^{\circ}\text{C}$

## ABSOLUTE MAXIMUM RATINGS

Table 4.

Parameter	Rating
Supply Voltage	12 V
$V_{OCM}$	$V_{S+}$ to $V_{S-}$
Power Dissipation	See Figure 3
Input Common-Mode Voltage	$V_{S+}$ to $V_{S-}$
Storage Temperature Range	-65°C to +125°C
Operating Temperature Range	-40°C to +125°C
Lead Temperature (Soldering, 10 sec)	300°C
Junction Temperature	150°C

Stresses above those listed under Absolute Maximum Ratings may cause permanent damage to the device. This is a stress rating only; functional operation of the device at these or any other conditions above those indicated in the operational section of this specification is not implied. Exposure to absolute maximum rating conditions for extended periods may affect device reliability.

### THERMAL RESISTANCE

$\theta_{JA}$  is specified for the worst-case conditions, that is,  $\theta_{JA}$  is specified for the device soldered in a circuit board in still air.

Table 5. Thermal Resistance

Package Type	$\theta_{JA}$	$\theta_{JC}$	Unit
8-Lead SOIC/2-Layer	157	56	°C/W
8-Lead SOIC/4-Layer	125	56	°C/W
8-Lead LFCSP/4-Layer	70	56	°C/W

### MAXIMUM POWER DISSIPATION

The maximum safe power dissipation in the AD8137 package is limited by the associated rise in junction temperature ( $T_j$ ) on the die. At approximately 150°C, which is the glass transition temperature, the plastic changes its properties. Even temporarily exceeding this temperature limit may change the stresses that the package exerts on the die, permanently shifting the parametric performance of the AD8137. Exceeding a junction temperature of 175°C for an extended period can result in changes in the silicon devices, potentially causing failure.

The power dissipated in the package ( $P_D$ ) is the sum of the quiescent power dissipation and the power dissipated in the package due to the load drive for all outputs. The quiescent power is the voltage between the supply pins ( $V_S$ ) times the quiescent current ( $I_S$ ). The load current consists of differential and common-mode currents flowing to the load, as well as currents flowing through the external feedback networks and the internal common-mode feedback loop. The internal resistor tap used in the common-mode feedback loop places a 1 k $\Omega$  differential load on the output. RMS output voltages should be considered when dealing with ac signals.

Airflow reduces  $\theta_{JA}$ . In addition, more metal directly in contact with the package leads from metal traces, through holes, ground, and power planes reduces the  $\theta_{JA}$ .

Figure 3 shows the maximum safe power dissipation in the package vs. the ambient temperature for the 8-lead SOIC (125°C/W) and 8-lead LFCSP ( $\theta_{JA} = 70^\circ\text{C}/\text{W}$ ) on a JEDEC standard 4-layer board.  $\theta_{JA}$  values are approximations.

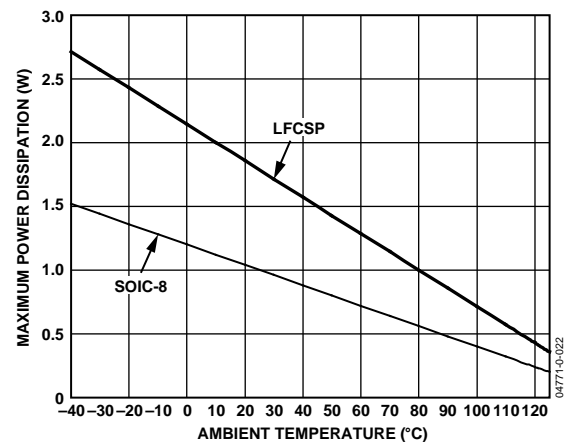

Figure 3. Maximum Power Dissipation vs. Ambient Temperature for a 4-Layer Board

### ESD CAUTION



**ESD (electrostatic discharge) sensitive device.** Charged devices and circuit boards can discharge without detection. Although this product features patented or proprietary protection circuitry, damage may occur on devices subjected to high energy ESD. Therefore, proper ESD precautions should be taken to avoid performance degradation or loss of functionality.

## PIN CONFIGURATION AND FUNCTION DESCRIPTIONS

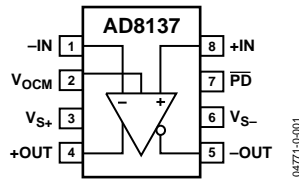

Figure 4. Pin Configuration

Table 6. Pin Function Descriptions

Pin No.	Mnemonic	Description
1	-IN	Inverting Input.
2	$V_{OCM}$	An internal feedback loop drives the output common-mode voltage to be equal to the voltage applied to the $V_{OCM}$ pin, provided the operation of the amplifier remains linear.
3	$V_{S+}$	Positive Power Supply Voltage.
4	+OUT	Positive Side of the Differential Output.
5	-OUT	Negative Side of the Differential Output.
6	$V_{S-}$	Negative Power Supply Voltage.
7	$\overline{PD}$	Power Down.
8	+IN	Noninverting Input.
	EPAD	Exposed paddle may be connected to either ground plane or power plane.

# TYPICAL PERFORMANCE CHARACTERISTICS

Unless otherwise noted, differential gain = 1,  $R_G = R_F = R_{L, dm} = 1\text{ k}\Omega$ ,  $V_S = 5\text{ V}$ ,  $T_A = 25^\circ\text{C}$ ,  $V_{OCM} = 2.5\text{V}$ . Refer to the basic test circuit in Figure 60 for the definition of terms.

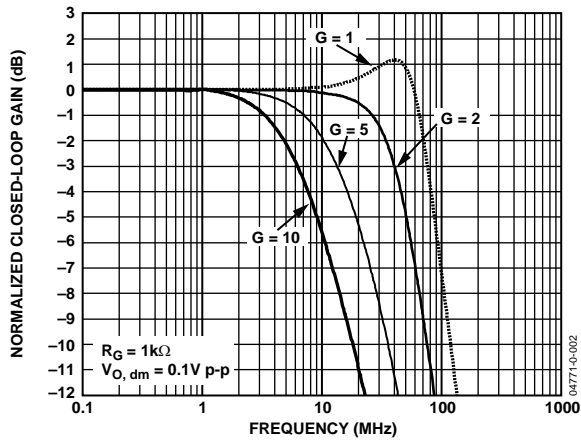

Figure 5. Small Signal Frequency Response for Various Gains

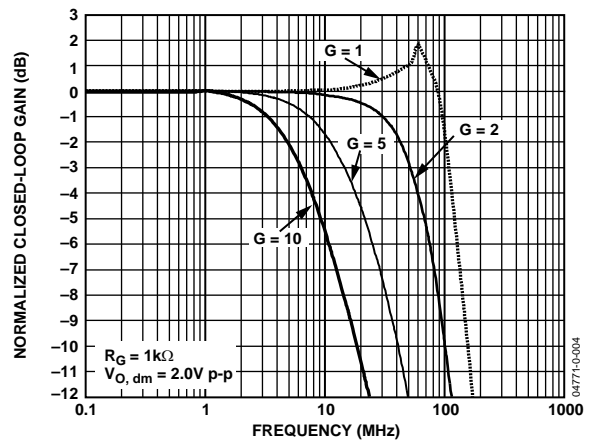

Figure 8. Large Signal Frequency Response for Various Gains

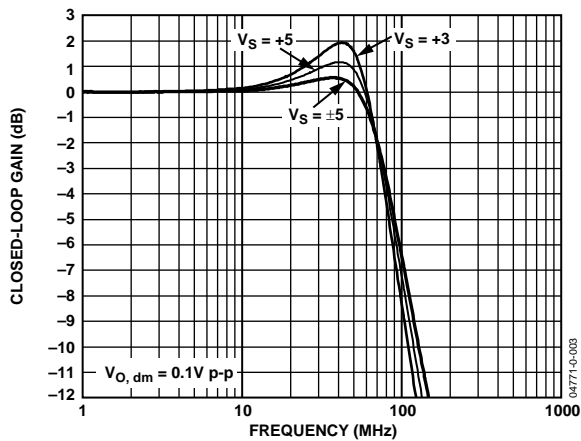

Figure 6. Small Signal Frequency Response for Various Power Supplies

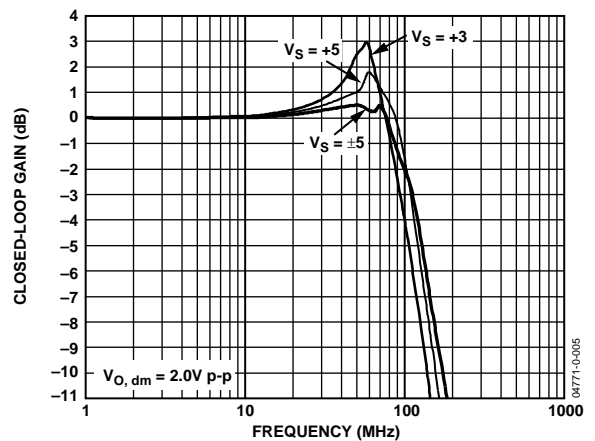

Figure 9. Large Signal Frequency Response for Various Power Supplies

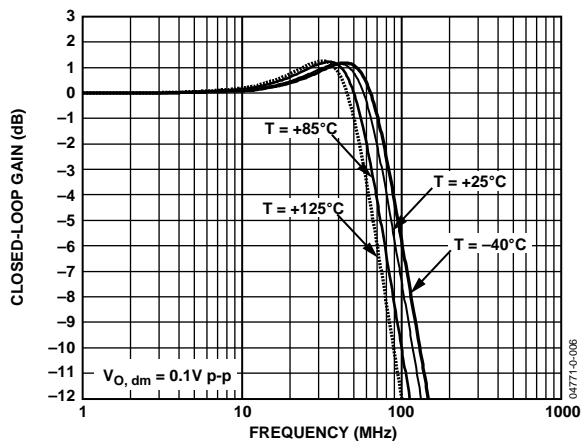

Figure 7. Small Signal Frequency Response at Various Temperatures

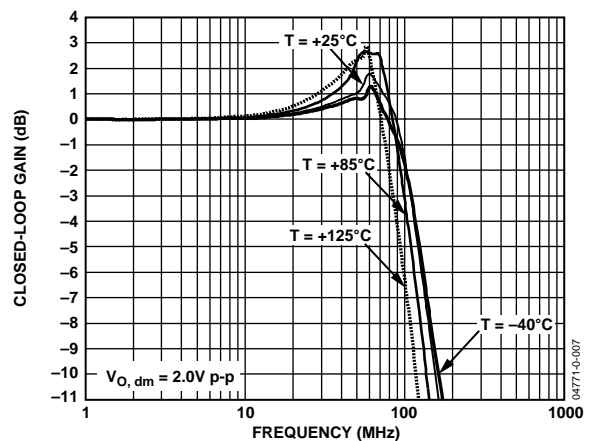

Figure 10. Large Signal Frequency Response at Various Temperatures

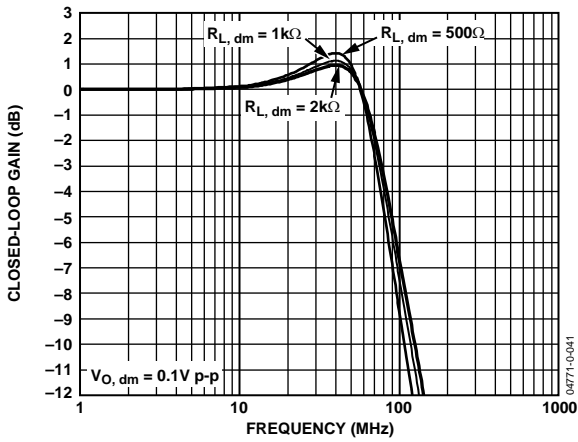

Figure 11. Small Signal Frequency Response for Various Loads

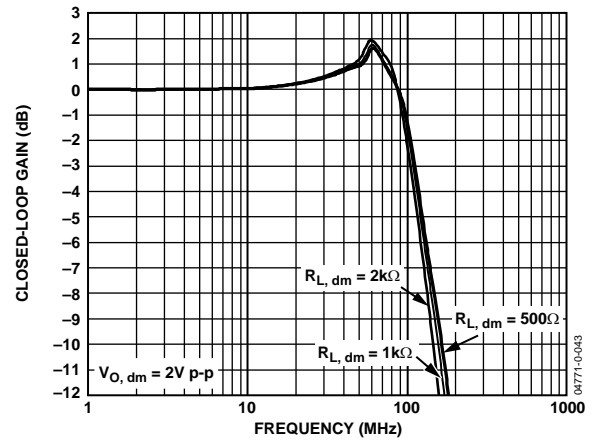

Figure 14. Large Signal Frequency Response for Various Loads

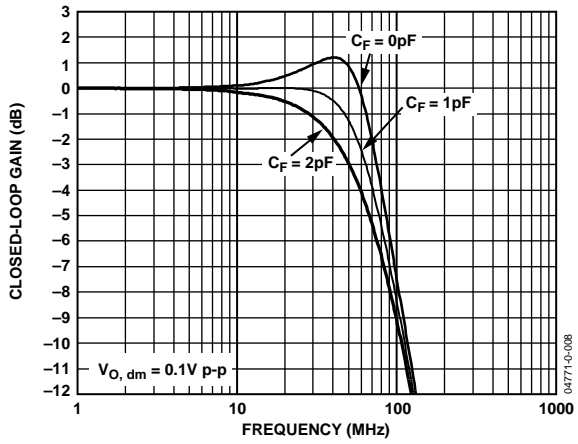

Figure 12. Small Signal Frequency Response for Various  $C_F$

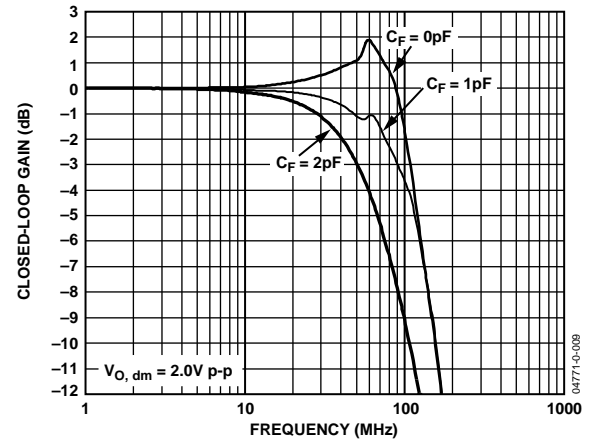

Figure 15. Large Signal Frequency Response for Various  $C_F$

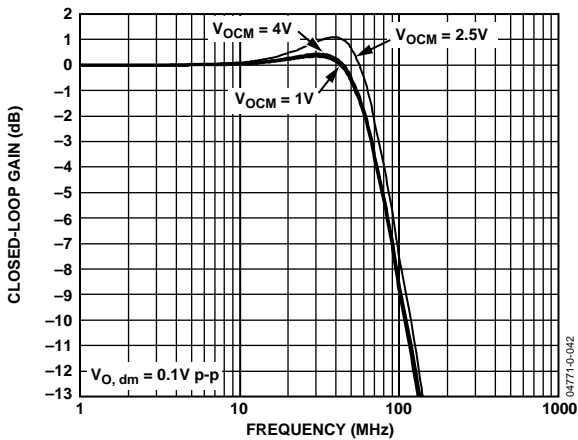

Figure 13. Small Signal Frequency Response at Various  $V_{OCM}$

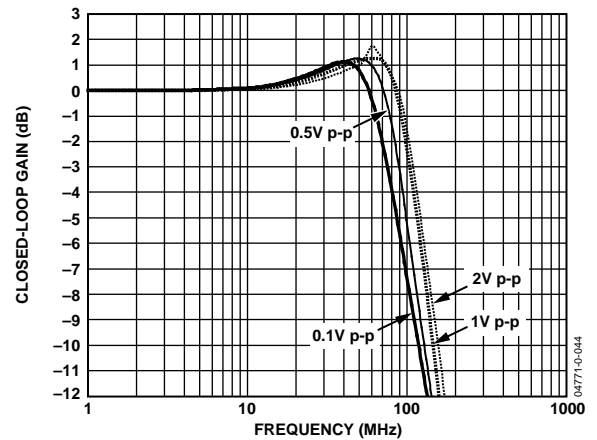

Figure 16. Frequency Response for Various Output Amplitudes

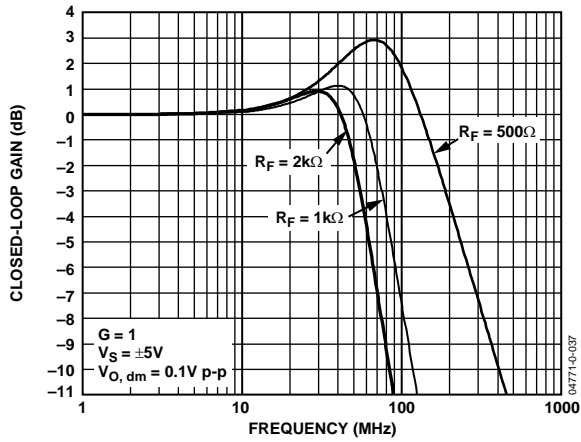

Figure 17. Small Signal Frequency Response for Various  $R_f$

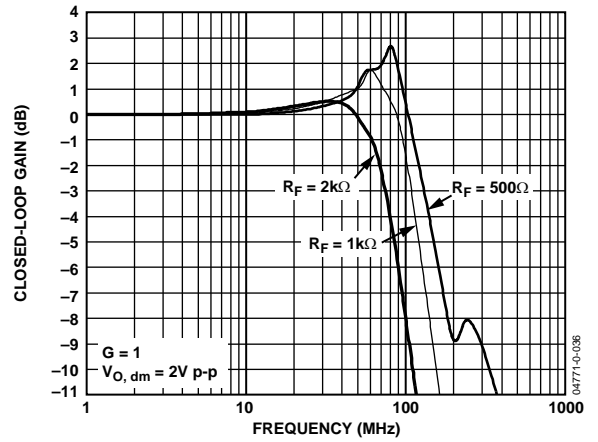

Figure 20. Large Signal Frequency Response for Various  $R_f$

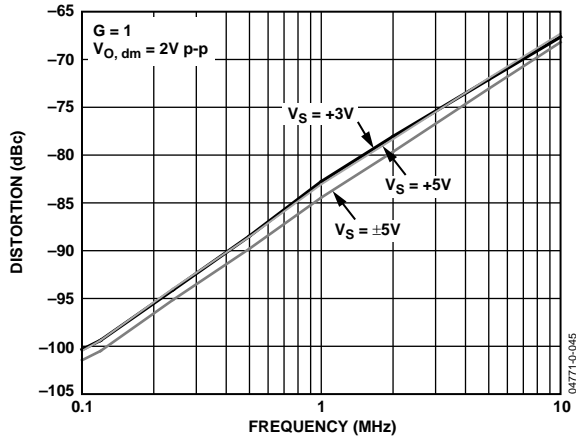

Figure 18. Second Harmonic Distortion vs. Frequency and Supply Voltage

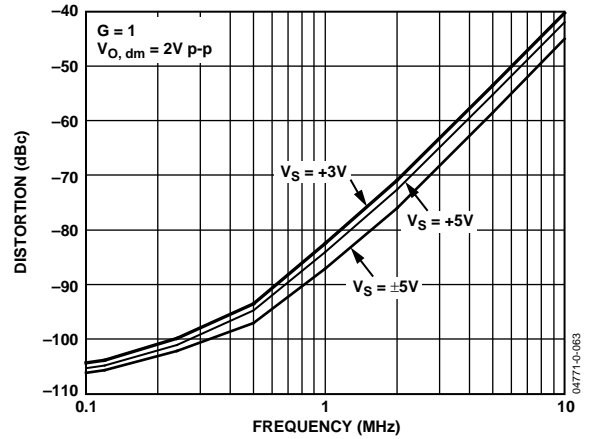

Figure 21. Third Harmonic Distortion vs. Frequency and Supply Voltage

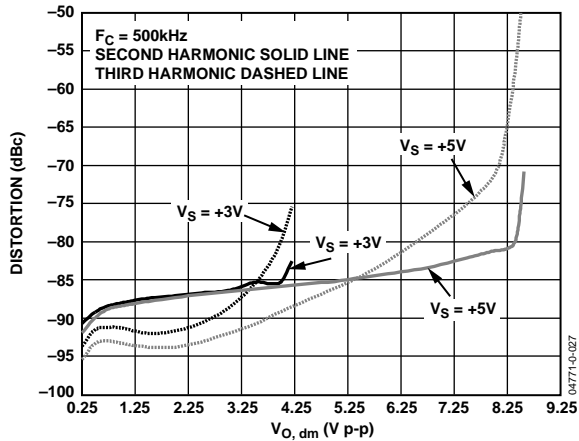

Figure 19. Harmonic Distortion vs. Output Amplitude and Supply,  $F_c = 500 \text{ kHz}$

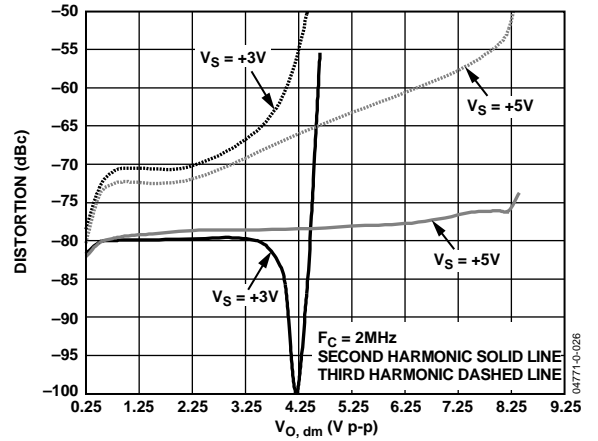

Figure 22. Harmonic Distortion vs. Output Amplitude and Supply,  $F_c = 2 \text{ MHz}$

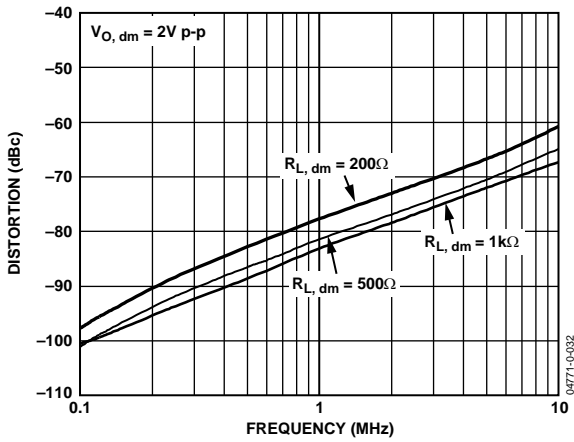

Figure 23. Second Harmonic Distortion at Various Loads

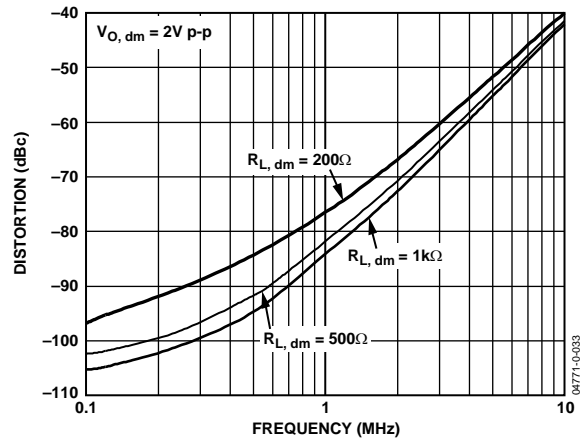

Figure 26. Third Harmonic Distortion at Various Loads

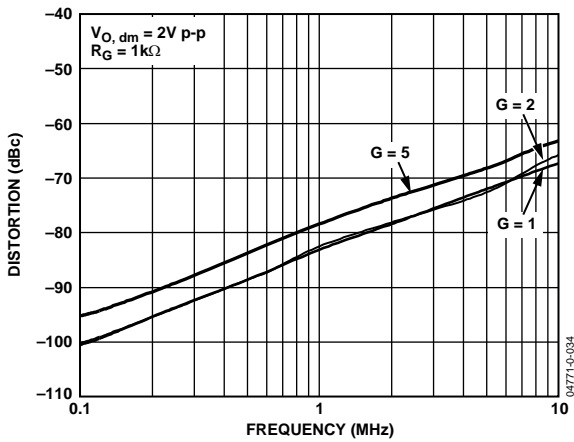

Figure 24. Second Harmonic Distortion at Various Gains

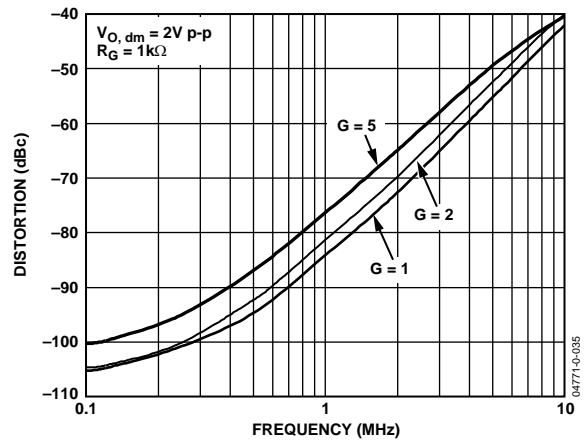

Figure 27. Third Harmonic Distortion at Various Gains

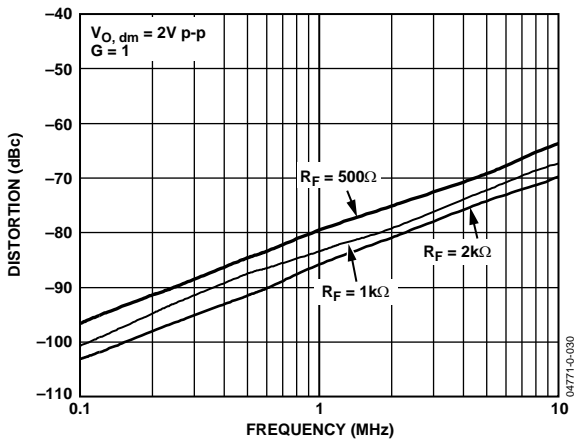

Figure 25. Second Harmonic Distortion at Various  $R_F$

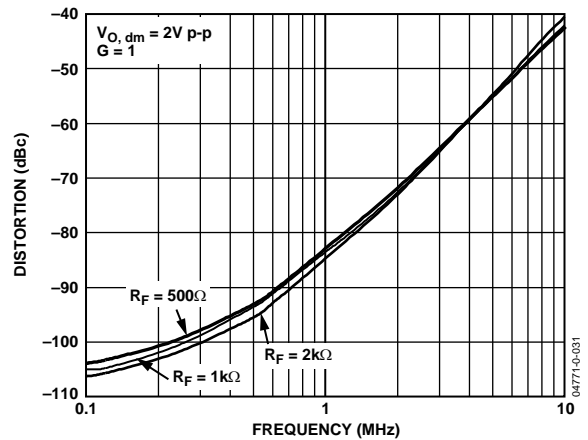

Figure 28. Third Harmonic Distortion at Various  $R_F$

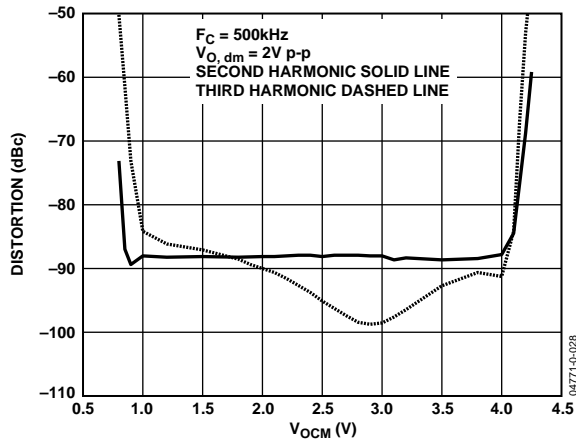

Figure 29. Harmonic Distortion vs.  $V_{OCM}$ ,  $V_S = 5 V$

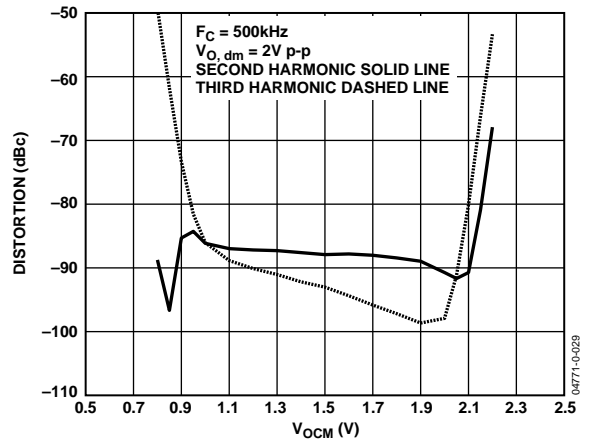

Figure 32. Harmonic Distortion vs.  $V_{OCM}$ ,  $V_S = 3 V$

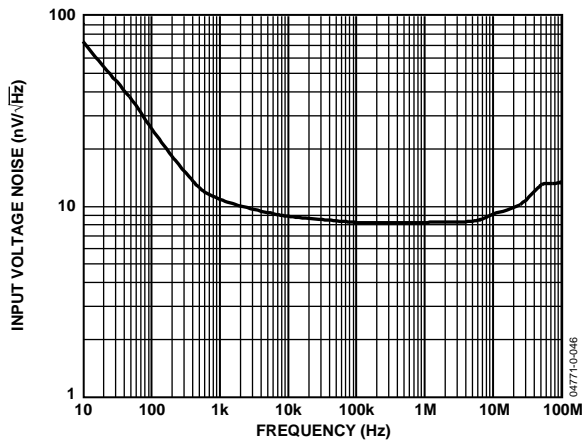

Figure 30. Input Voltage Noise vs. Frequency

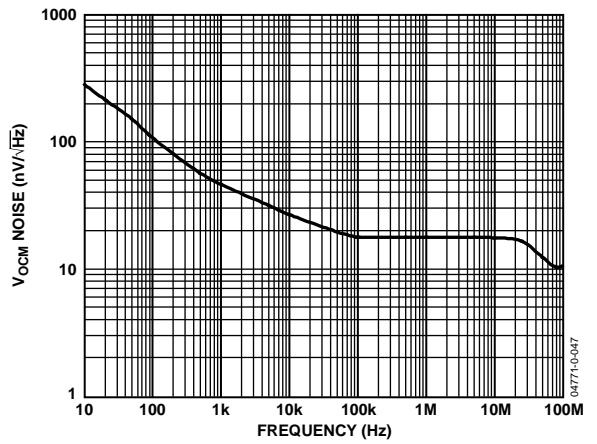

Figure 33.  $V_{OCM}$  Voltage Noise vs. Frequency

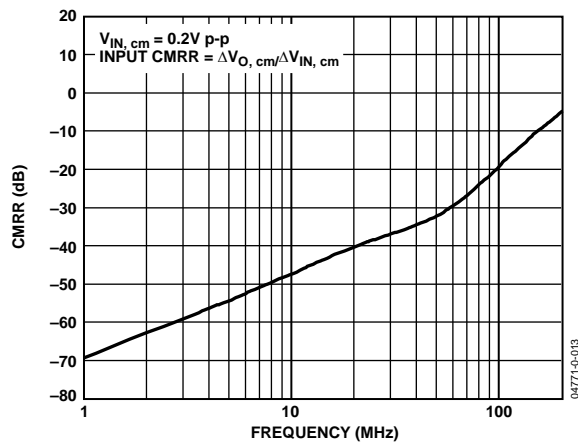

Figure 31. CMRR vs. Frequency

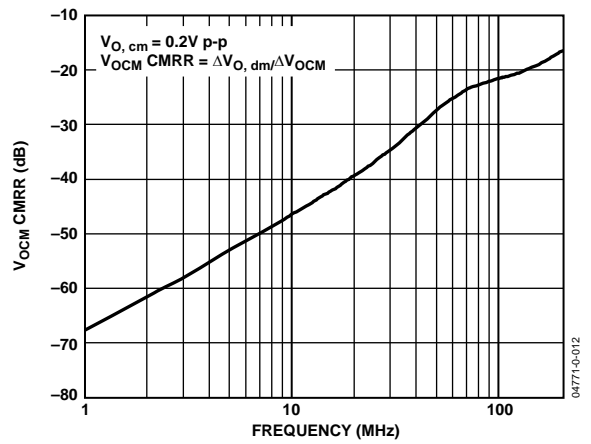

Figure 34.  $V_{OCM}$  CMRR vs. Frequency



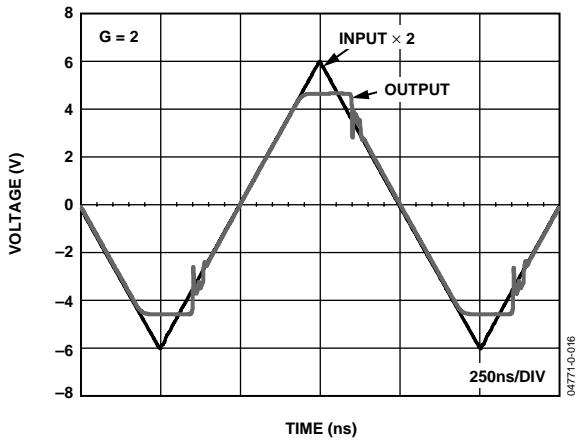

Figure 35. Overdrive Recovery

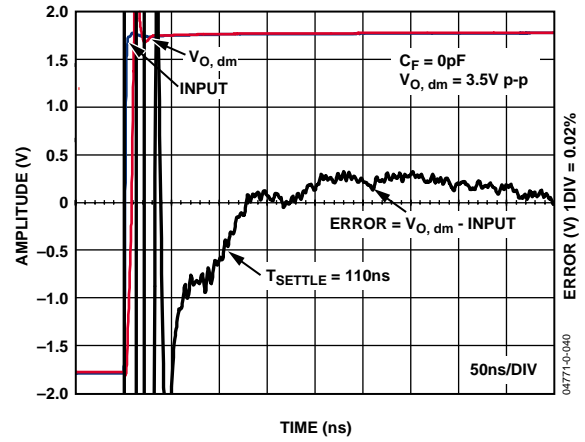

Figure 38. Settling Time (0.02%)

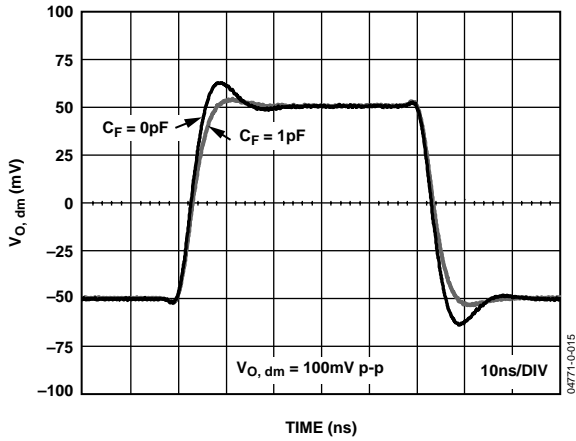

Figure 36. Small Signal Transient Response for Various Feedback Capacitances

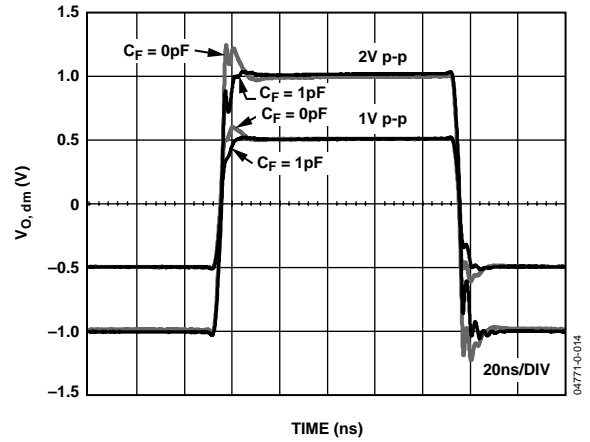

Figure 39. Large Signal Transient Response for Various Feedback Capacitances

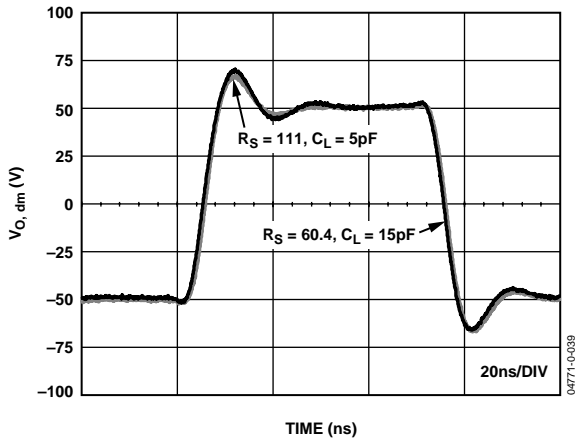

Figure 37. Small Signal Transient Response for Various Capacitive Loads

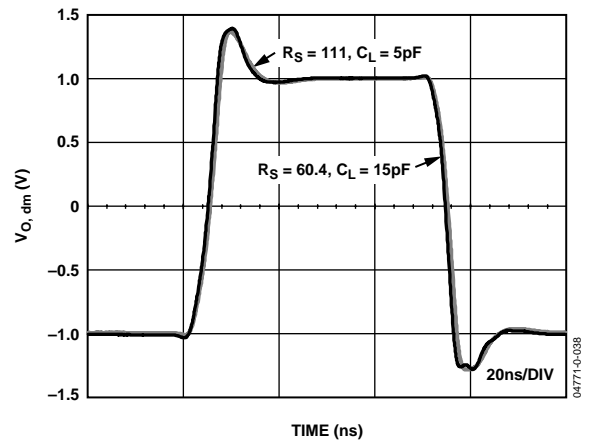

Figure 40. Large Signal Transient Response for Various Capacitive Loads

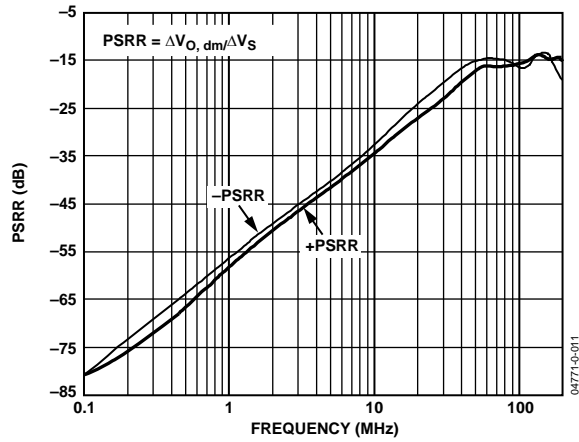

Figure 41. PSRR vs. Frequency

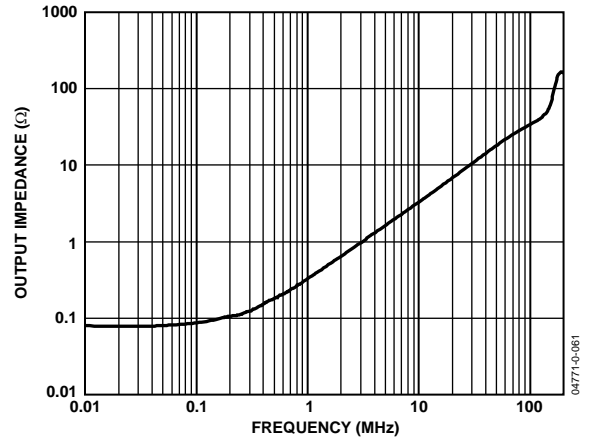

Figure 44. Single-Ended Output Impedance vs. Frequency

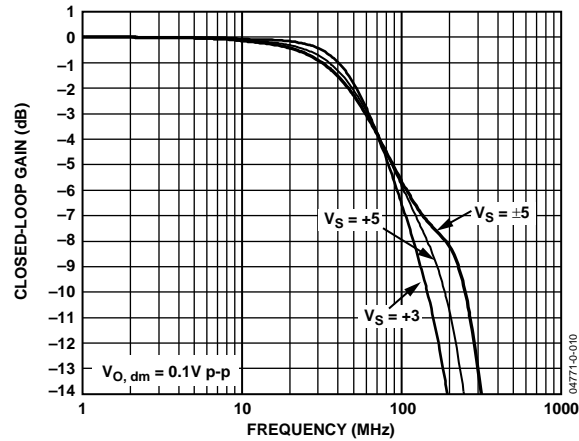

Figure 42.  $V_{OCM}$  Small Signal Frequency Response for Various Supply Voltages

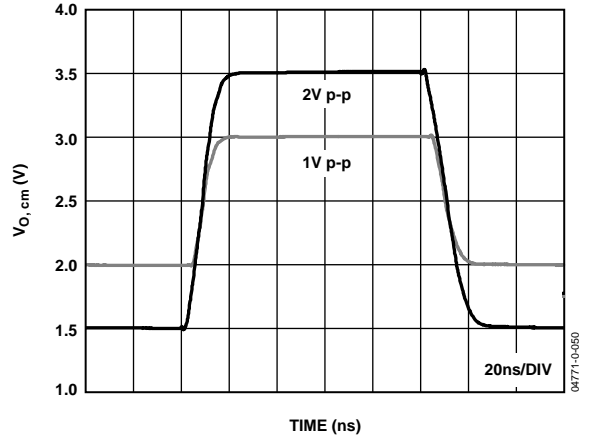

Figure 45.  $V_{OCM}$  Large Signal Transient Response

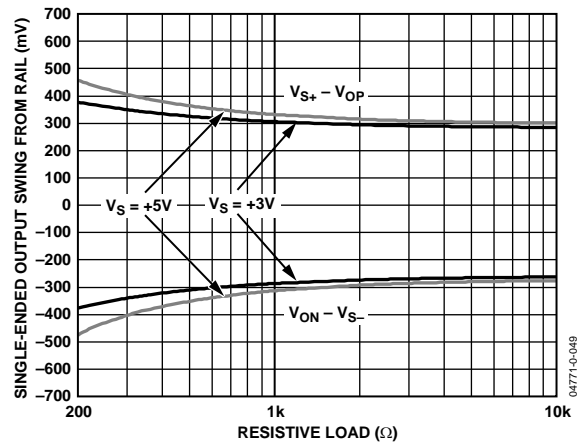

Figure 43. Output Saturation Voltage vs. Output Load

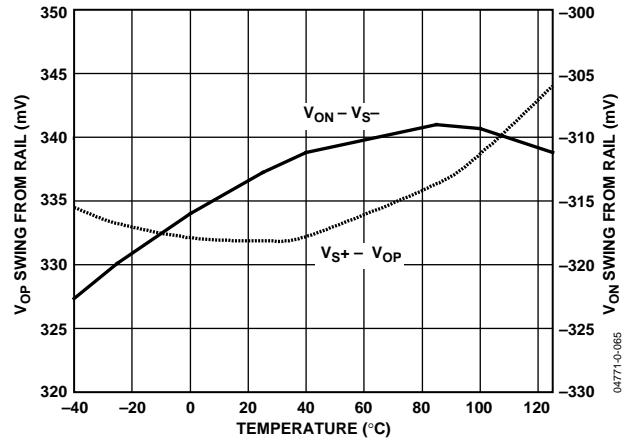

Figure 46. Output Saturation Voltage vs. Temperature

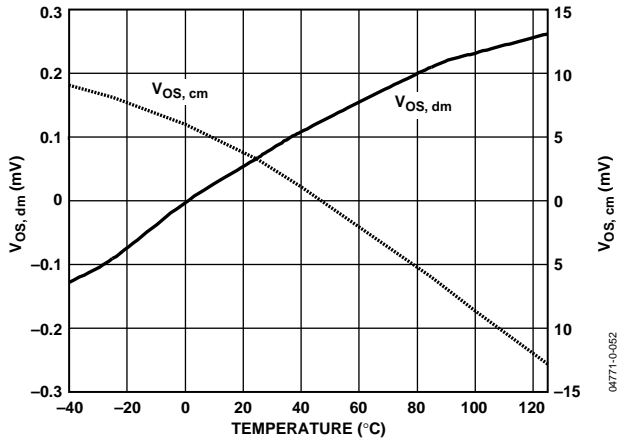

Figure 47. Offset Voltage vs. Temperature

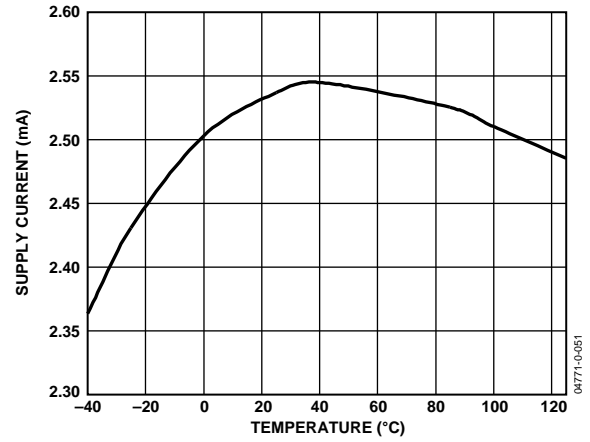

Figure 50. Supply Current vs. Temperature

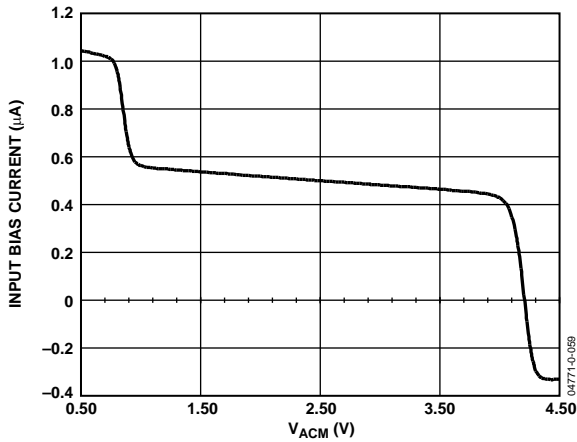

Figure 48. Input Bias Current vs. Input Common-Mode Voltage, V<sub>ACM</sub>

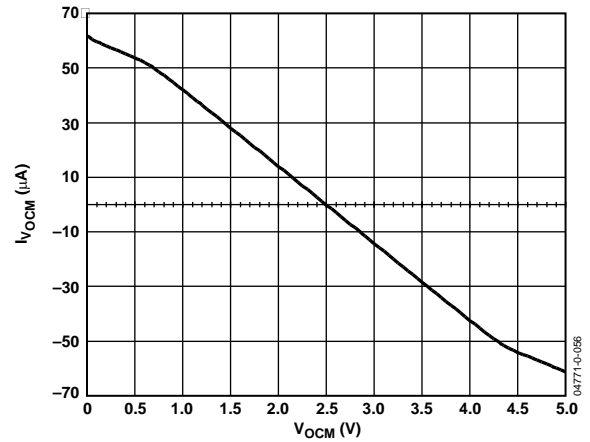

Figure 51. V<sub>OCM</sub> Bias Current vs. V<sub>OCM</sub> Input Voltage

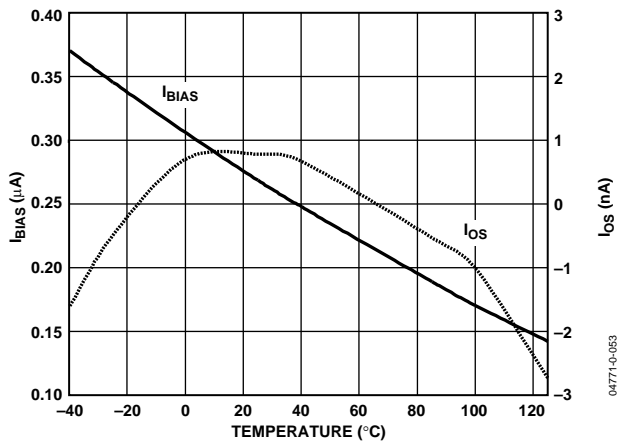

Figure 49. Input Bias and Offset Current vs. Temperature

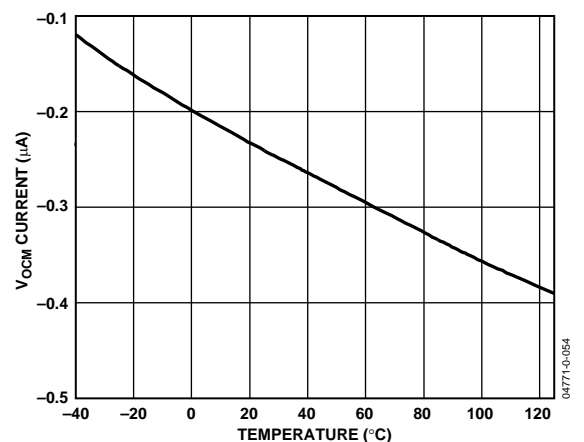

Figure 52. V<sub>OCM</sub> Bias Current vs. Temperature

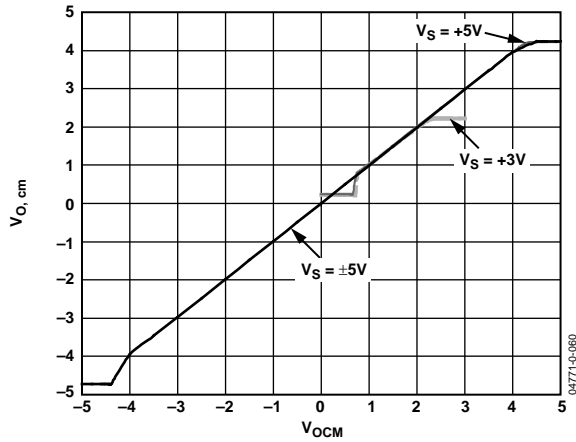

Figure 53.  $V_{O,cm}$  vs.  $V_{OCM}$  Input Voltage

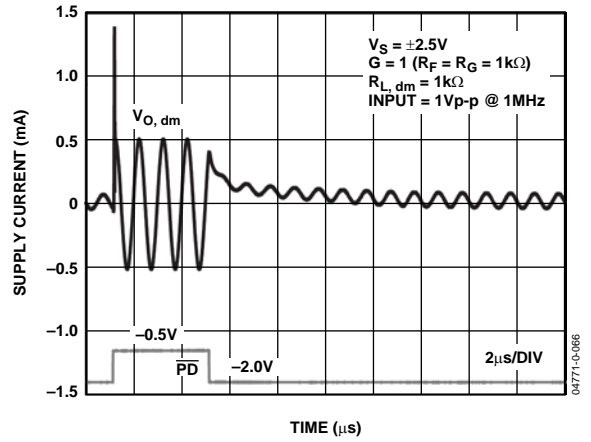

Figure 56. Power-Down Transient Response

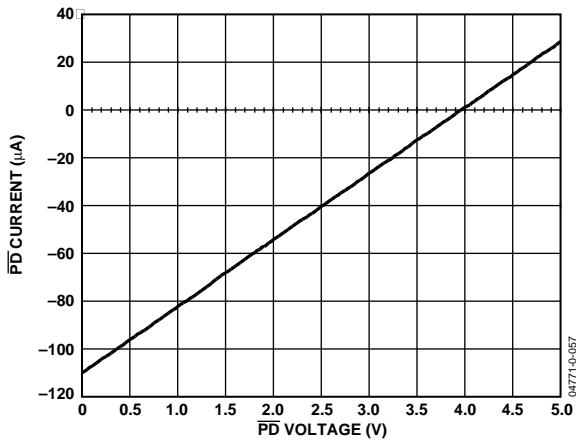

Figure 54.  $\overline{PD}$  Current vs.  $\overline{PD}$  Voltage

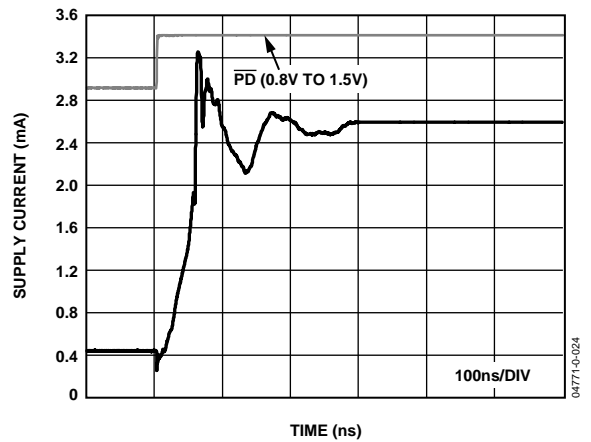

Figure 57. Power-Down Turn-On Time

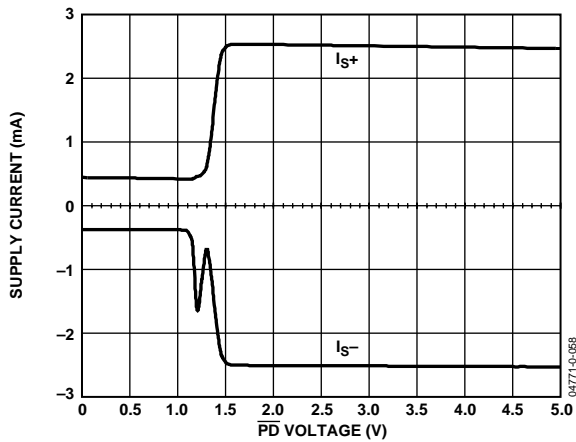

Figure 55. Supply Current vs.  $\overline{PD}$  Voltage

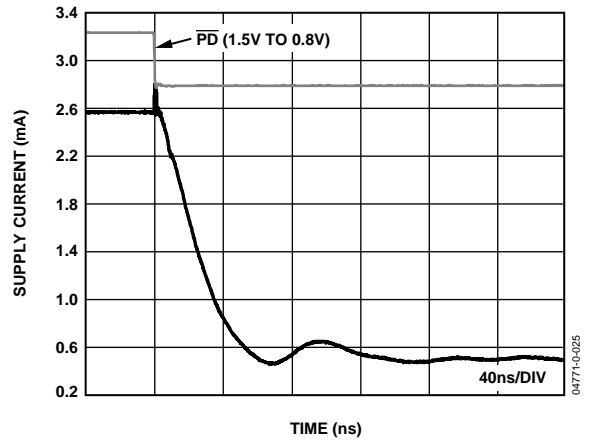

Figure 58. Power-Down Turn-Off Time

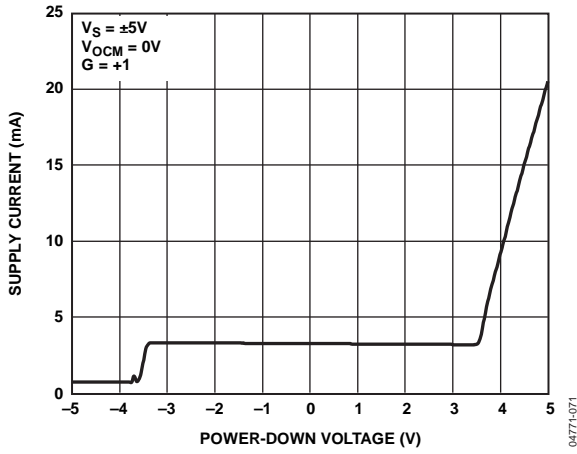

Figure 59. Supply Current vs. Power-Down Voltage

TEST CIRCUITS

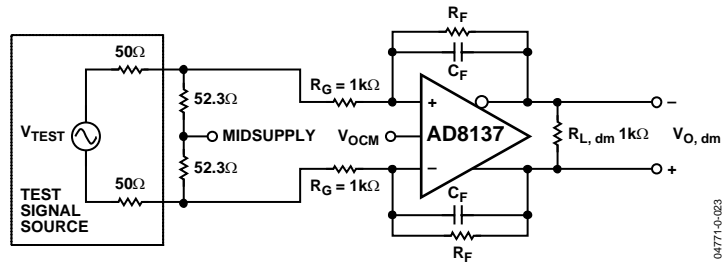

Figure 60. Basic Test Circuit

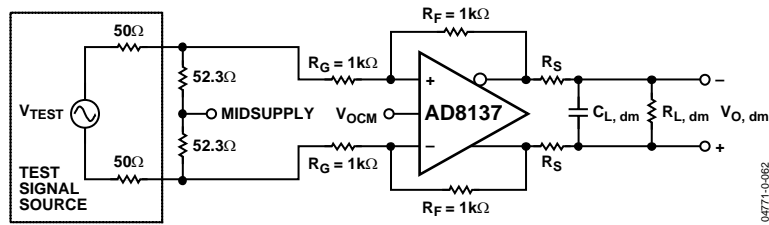

Figure 61. Capacitive Load Test Circuit,  $G = 1$

## THEORY OF OPERATION

The AD8137 is a low power, low cost, fully differential voltage feedback amplifier that features a rail-to-rail output stage, common-mode circuitry with an internally derived common-mode reference voltage, and bias shutdown circuitry. The amplifier uses two feedback loops to separately control differential and common-mode feedback. The differential gain is set with external resistors as in a traditional amplifier, and the output common-mode voltage is set by an internal feedback loop, controlled by an external  $V_{OCM}$  input. This architecture makes it easy to set arbitrarily the output common-mode voltage level without affecting the differential gain of the amplifier.

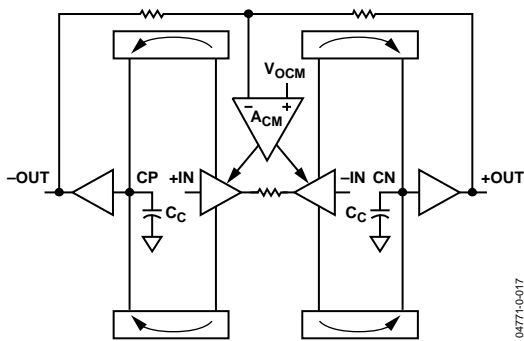

Figure 62. Block Diagram

From Figure 62, the input transconductance stage is an H-bridge whose output current is mirrored to high impedance nodes CP and CN. The output section is traditional H-bridge driven circuitry with common emitter devices driving nodes +OUT and -OUT. The 3 dB point of the amplifier is defined as

$$BW = \frac{g_m}{2\pi \times C_C}$$

where:

$g_m$  is the transconductance of the input stage.

$C_C$  is the total capacitance on node CP/CN (capacitances CP and CN are well matched).

For the AD8137, the input stage  $g_m$  is  $\sim 1$  mA/V and the capacitance  $C_C$  is 3.5 pF, setting the crossover frequency of the amplifier at 41 MHz. This frequency generally establishes an amplifier's unity gain bandwidth, but with the AD8137, the closed-loop bandwidth depends upon the feedback resistor value as well (see Figure 17). The open-loop gain and phase simulations are shown in Figure 63.

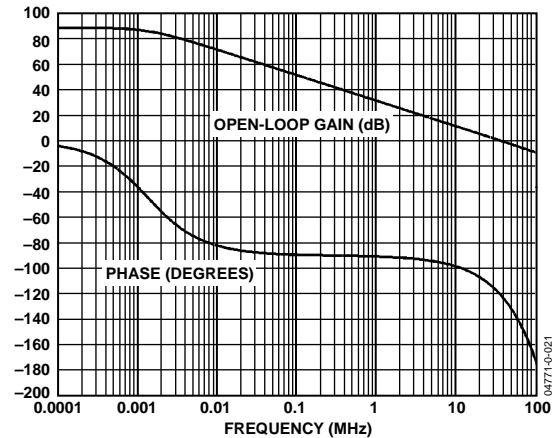

Figure 63. Open-Loop Gain and Phase

In Figure 62, the common-mode feedback amplifier  $A_{CM}$  samples the output common-mode voltage, and by negative feedback forces the output common-mode voltage to be equal to the voltage applied to the  $V_{OCM}$  input. In other words, the feedback loop serves the output common-mode voltage to the voltage applied to the  $V_{OCM}$  input. An internal bias generator sets the  $V_{OCM}$  level to approximately midsupply; therefore, the output common-mode voltage is set to approximately midsupply when the  $V_{OCM}$  input is left floating. The source resistance of the internal bias generator is large and can be overridden easily by an external voltage supplied by a source with a relatively small output resistance. The  $V_{OCM}$  input can be driven to within approximately 1 V of the supply rails while maintaining linear operation in the common-mode feedback loop.

The common-mode feedback loop inside the AD8137 produces outputs that are highly balanced over a wide frequency range without the requirement of tightly matched external components, because it forces the signal component of the output common-mode voltage to be zeroed. The result is nearly perfectly balanced differential outputs of identical amplitude and exactly  $180^\circ$  apart in phase.

## APPLICATIONS INFORMATION

### ANALYZING A TYPICAL APPLICATION WITH MATCHED $R_F$ AND $R_G$ NETWORKS

#### Typical Connection and Definition of Terms

Figure 64 shows a typical connection for the AD8137, using matched external  $R_F/R_G$  networks. The differential input terminals of the AD8137,  $V_{AP}$  and  $V_{AN}$ , are used as summing junctions. An external reference voltage applied to the  $V_{OCM}$  terminal sets the output common-mode voltage. The two output terminals,  $V_{OP}$  and  $V_{ON}$ , move in opposite directions in a balanced fashion in response to an input signal.

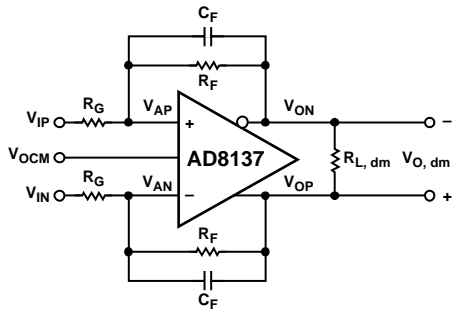

Figure 64. Typical Connection

The differential output voltage is defined as

$$V_{O, dm} = V_{OP} - V_{ON} \quad (1)$$

Common-mode voltage is the average of two voltages. The output common-mode voltage is defined as

$$V_{O, cm} = \frac{V_{OP} + V_{ON}}{2} \quad (2)$$

#### Output Balance

Output balance is a measure of how well  $V_{OP}$  and  $V_{ON}$  are matched in amplitude and how precisely they are  $180^\circ$  out of phase with each other. It is the internal common-mode feedback loop that forces the signal component of the output common-mode toward zero, resulting in the near perfectly balanced differential outputs of identical amplitude and are exactly  $180^\circ$  out of phase. The output balance performance does not require tightly matched external components, nor does it require that the feedback factors of each loop be equal to each other. Low frequency output balance is ultimately limited by the mismatch of an on-chip voltage divider.

Output balance is measured by placing a well-matched resistor divider across the differential voltage outputs and comparing the signal at the divider's midpoint with the magnitude of the differential output. By this definition, output balance is equal to the magnitude of the change in output common-mode voltage divided by the magnitude of the change in output differential mode voltage:

$$\text{Output Balance} = \frac{|\Delta V_{O, cm}|}{|\Delta V_{O, dm}|} \quad (3)$$

The differential negative feedback drives the voltages at the summing junctions  $V_{AN}$  and  $V_{AP}$  to be essentially equal to each other.

$$V_{AN} = V_{AP} \quad (4)$$

The common-mode feedback loop drives the output common-mode voltage, sampled at the midpoint of the two internal common-mode tap resistors in Figure 62, to equal the voltage set at the  $V_{OCM}$  terminal. This ensures that

$$V_{OP} = V_{OCM} + \frac{V_{O, dm}}{2} \quad (5)$$

and

$$V_{ON} = V_{OCM} - \frac{V_{O, dm}}{2} \quad (6)$$

### ESTIMATING NOISE, GAIN, AND BANDWIDTH WITH MATCHED FEEDBACK NETWORKS

#### Estimating Output Noise Voltage and Bandwidth

The total output noise is the root-sum-squared total of several statistically independent sources. Because the sources are statistically independent, the contributions of each must be individually included in the root-sum-square calculation. Table 7 lists recommended resistor values and estimates of bandwidth and output differential voltage noise for various closed-loop gains. For most applications, 1% resistors are sufficient.

Table 7. Recommended Values of Gain-Setting Resistors and Voltage Gain for Various Closed-Loop Gains

Gain	$R_G$ ( $\Omega$ )	$R_F$ ( $\Omega$ )	3 dB Bandwidth (MHz)	Total Output Noise (nV/ $\sqrt{\text{Hz}}$ )
1	1 k	1 k	72	18.6
2	1 k	2 k	40	28.9
5	1 k	5 k	12	60.1
10	1 k	10 k	6	112.0



The differential output voltage noise contains contributions from the AD8137's input voltage noise and input current noise as well as those from the external feedback networks.

The contribution from the input voltage noise spectral density is computed as

$$V_{O\_n1} = v_n \left( 1 + \frac{R_F}{R_G} \right), \text{ or equivalently, } v_n / \beta \quad (7)$$

where  $v_n$  is defined as the input-referred differential voltage noise. This equation is the same as that of traditional op amps.

The contribution from the input current noise of each input is computed as

$$V_{O\_n2} = i_n (R_F) \quad (8)$$

where  $i_n$  is defined as the input noise current of one input. Each input needs to be treated separately because the two input currents are statistically independent processes.

The contribution from each  $R_G$  is computed as

$$V_{O\_n3} = \sqrt{4kTR_G} \left( \frac{R_F}{R_G} \right) \quad (9)$$

This result can be intuitively viewed as the thermal noise of each  $R_G$  multiplied by the magnitude of the differential gain.

The contribution from each  $R_F$  is computed as

$$V_{O\_n4} = \sqrt{4kTR_F} \quad (10)$$

### Voltage Gain

The behavior of the node voltages of the single-ended-to-differential output topology can be deduced from the signal definitions and Figure 64. Referring to Figure 64,  $C_F = 0$  and setting  $V_{IN} = 0$ , one can write:

$$\frac{V_{IP} - V_{AP}}{R_G} = \frac{V_{AP} - V_{ON}}{R_F} \quad (11)$$

$$V_{AN} = V_{AP} = V_{OP} \left[ \frac{R_G}{R_F + R_G} \right] \quad (12)$$

Solving the previous two equations and setting  $V_{IP}$  to  $V_i$  gives the gain relationship for  $V_{O, dm} / V_i$ .

$$V_{OP} - V_{ON} = V_{O, dm} = \frac{R_F}{R_G} V_i \quad (13)$$

An inverting configuration with the same gain magnitude can be implemented by simply applying the input signal to  $V_{IN}$  and setting  $V_{IP} = 0$ . For a balanced differential input, the gain from  $V_{IN, dm}$  to  $V_{O, dm}$  is also equal to  $R_F / R_G$ , where  $V_{IN, dm} = V_{IP} - V_{IN}$ .

### Feedback Factor Notation

When working with differential drivers, it is convenient to introduce the feedback factor  $\beta$ , which is defined as

$$\beta \equiv \frac{R_G}{R_F + R_G} \quad (14)$$

This notation is consistent with conventional feedback analysis and is very useful, particularly when the two feedback loops are not matched.

### Input Common-Mode Voltage

The linear range of the  $V_{AN}$  and  $V_{AP}$  terminals extends to within approximately 1 V of either supply rail. Because  $V_{AN}$  and  $V_{AP}$  are essentially equal to each other, they are both equal to the amplifier's input common-mode voltage. Their range is indicated in the specifications tables as input common-mode range. The voltage at  $V_{AN}$  and  $V_{AP}$  for the connection diagram in Figure 64 can be expressed as

$$V_{AN} = V_{AP} = V_{ACM} = \left( \frac{R_F}{R_F + R_G} \times \frac{(V_{IP} + V_{IN})}{2} \right) + \left( \frac{R_G}{R_F + R_G} \times V_{OCM} \right) \quad (15)$$

where  $V_{ACM}$  is the common-mode voltage present at the amplifier input terminals.

Using the  $\beta$  notation, Equation (15) can be written as

$$V_{ACM} = \beta V_{OCM} + (1 - \beta) V_{ICM} \quad (16)$$

or equivalently,

$$V_{ACM} = V_{ICM} + \beta(V_{OCM} - V_{ICM}) \quad (17)$$

where  $V_{ICM}$  is the common-mode voltage of the input signal, that is

$$V_{ICM} \equiv \frac{V_{IP} + V_{IN}}{2}$$

For proper operation, the voltages at  $V_{AN}$  and  $V_{AP}$  must stay within their respective linear ranges.

### Calculating Input Impedance

The input impedance of the circuit in Figure 64 depends on whether the amplifier is being driven by a single-ended or a differential signal source. For balanced differential input signals, the differential input impedance ( $R_{IN, dm}$ ) is simply

$$R_{IN, dm} = 2R_G \quad (18)$$

For a single-ended signal (for example, when  $V_{IN}$  is grounded and the input signal drives  $V_{IP}$ ), the input impedance becomes

$$R_{IN} = \frac{R_G}{1 - \frac{R_F}{2(R_G + R_F)}} \quad (19)$$

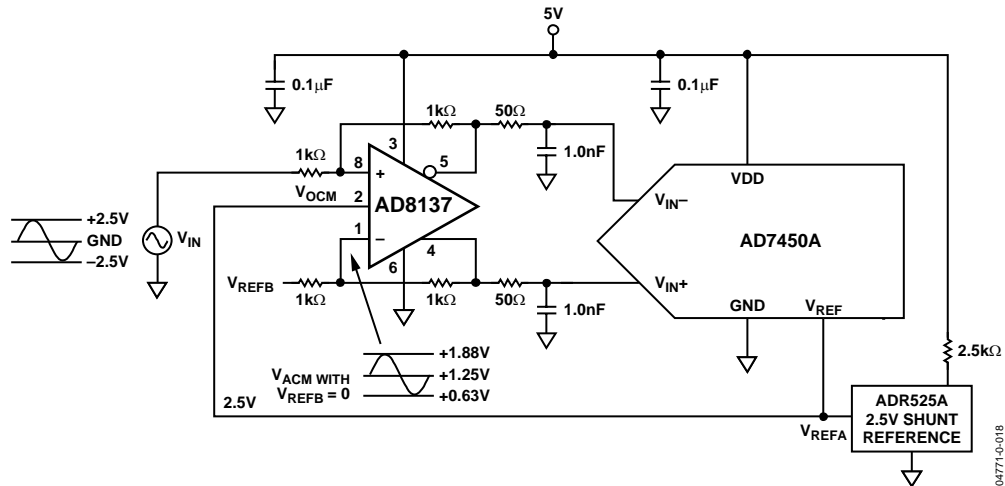

Figure 65. AD8137 Driving AD7450A, 12-Bit ADC

The input impedance of a conventional inverting op amp configuration is simply  $R_G$ ; however, it is higher in Equation 19 because a fraction of the differential output voltage appears at the summing junctions,  $V_{AN}$  and  $V_{AP}$ . This voltage partially bootstraps the voltage across the input resistor  $R_G$ , leading to the increased input resistance.

#### Input Common-Mode Swing Considerations

In some single-ended-to-differential applications, when using a single-supply voltage, attention must be paid to the swing of the input common-mode voltage,  $V_{ACM}$ .

Consider the case in Figure 65, where  $V_{IN}$  is 5 V p-p swinging about a baseline at ground and  $V_{REFB}$  is connected to ground. The input signal to the AD8137 is originating from a source with a very low output resistance.

The circuit has a differential gain of 1.0 and  $\beta = 0.5$ .  $V_{ICM}$  has an amplitude of 2.5 V p-p and is swinging about ground. Using the results in Equation 16, the common-mode voltage at the inputs of the AD8137,  $V_{ACM}$ , is a 1.25 V p-p signal swinging about a baseline of 1.25 V. The maximum negative excursion of  $V_{ACM}$  in this case is 0.63 V, which exceeds the lower input common-mode voltage limit.

One way to avoid the input common-mode swing limitation is to bias  $V_{IN}$  and  $V_{REF}$  at midsupply. In this case,  $V_{IN}$  is 5 V p-p swinging about a baseline at 2.5 V, and  $V_{REF}$  is connected to a low-Z 2.5 V source.  $V_{ICM}$  now has an amplitude of 2.5 V p-p and is swinging about 2.5 V. Using the results in Equation 17,  $V_{ACM}$  is calculated to be equal to  $V_{ICM}$  because  $V_{OCM} = V_{ICM}$ . Therefore,  $V_{ICM}$  swings from 1.25 V to 3.75 V, which is well within the input common-mode voltage limits of the AD8137. Another benefit seen by this example is that because  $V_{OCM} = V_{ACM} = V_{ICM}$ , no wasted common-mode current flows. Figure 66 illustrates a way to provide the low-Z bias voltage. For situations that do not require a precise reference, a simple voltage divider suffices to develop the input voltage to the buffer.

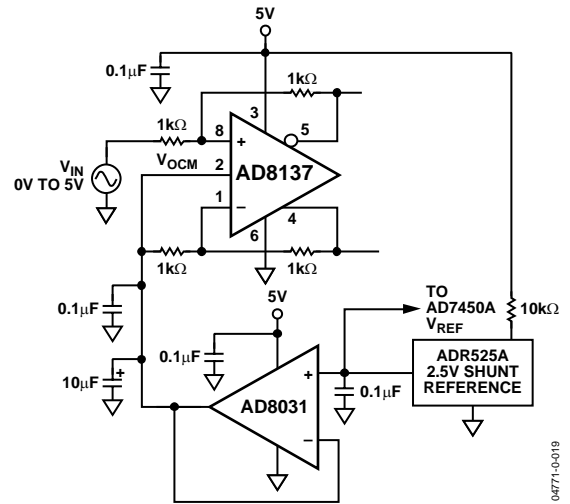

Figure 66. Low-Z Bias Source

Another way to avoid the input common-mode swing limitation is to use dual power supplies on the AD8137. In this case, the biasing circuitry is not required.

#### Bandwidth vs. Closed-Loop Gain

The 3 dB bandwidth of the AD8137 decreases proportionally to increasing closed-loop gain in the same way as a traditional voltage feedback operational amplifier. For closed-loop gains greater than 4, the bandwidth obtained for a specific gain can be estimated as

$$f_{-3dB}, V_{O, dm} = \frac{R_G}{R_G + R_F} \times (72 \text{ MHz}) \quad (20)$$

or equivalently,  $\beta(72 \text{ MHz})$ .

This estimate assumes a minimum 90° phase margin for the amplifier loop, a condition approached for gains greater than 4. Lower gains show more bandwidth than predicted by the equation due to the peaking produced by the lower phase margin.

### Estimating DC Errors

Primary differential output offset errors in the AD8137 are due to three major components: the input offset voltage, the offset between the  $V_{AN}$  and  $V_{AP}$  input currents interacting with the feedback network resistances, and the offset produced by the dc voltage difference between the input and output common-mode voltages in conjunction with matching errors in the feedback network.

The first output error component is calculated as

$$Vo_{e1} = V_{IO} \left( \frac{R_F + R_G}{R_G} \right), \text{ or equivalently as } V_{IO}/\beta \quad (21)$$

where  $V_{IO}$  is the input offset voltage.

The second error is calculated as

$$Vo_{e2} = I_{IO} \left( \frac{R_F + R_G}{R_G} \right) \left( \frac{R_G R_F}{R_F + R_G} \right) = I_{IO} (R_F) \quad (22)$$

where  $I_{IO}$  is defined as the offset between the two input bias currents.

The third error voltage is calculated as

$$Vo_{e3} = \Delta enr \times (V_{ICM} - V_{OCM}) \quad (23)$$

where  $\Delta enr$  is the fractional mismatch between the two feedback resistors.

The total differential offset error is the sum of these three error sources.

### Additional Impact of Mismatches in the Feedback Networks

The internal common-mode feedback network still forces the output voltages to remain balanced, even when the  $R_F/R_G$  feedback networks are mismatched. The mismatch, however, causes a gain error proportional to the feedback network mismatch.

Ratio-matching errors in the external resistors degrade the ability to reject common-mode signals at the  $V_{AN}$  and  $V_{IN}$  input terminals, similar to a four resistor, difference amplifier made from a conventional op amp. Ratio-matching errors also produce a differential output component that is equal to the  $V_{OCM}$  input voltage times the difference between the feedback factors ( $\beta$ s). In most applications using 1% resistors, this component amounts to a differential dc offset at the output that is small enough to be ignored.

### Driving a Capacitive Load

A purely capacitive load reacts with the bondwire and pin inductance of the AD8137, resulting in high frequency ringing in the transient response and loss of phase margin. One way to minimize this effect is to place a small resistor in series with each output to buffer the load capacitance. The resistor and load capacitance forms a first-order, low-pass filter; therefore, the resistor value should be as small as possible. In some cases, the ADCs require small series resistors to be added on their inputs.

Figure 37 and Figure 40 illustrate transient response vs. capacitive load and were generated using series resistors in each output and a differential capacitive load.

### Layout Considerations

Standard high speed PCB layout practices should be adhered to when designing with the AD8137. A solid ground plane is recommended and good wideband power supply decoupling networks should be placed as close as possible to the supply pins.

To minimize stray capacitance at the summing nodes, the copper in all layers under all traces and pads that connect to the summing nodes should be removed. Small amounts of stray summing-node capacitance cause peaking in the frequency response, and large amounts can cause instability. If some stray summing-node capacitance is unavoidable, its effects can be compensated for by placing small capacitors across the feedback resistors.

### Terminating a Single-Ended Input

Controlled impedance interconnections are used in most high speed signal applications, and they require at least one line termination. In analog applications, a matched resistive termination is generally placed at the load end of the line. This section deals with how to properly terminate a single-ended input to the AD8137.

The input resistance presented by the AD8137 input circuitry is seen in parallel with the termination resistor, and its loading effect must be taken into account. The Thevenin equivalent circuit of the driver, its source resistance, and the termination resistance must all be included in the calculation as well. An exact solution to the problem requires solution of several simultaneous algebraic equations and is beyond the scope of this data sheet. An iterative solution is also possible and is easier, especially considering the fact that standard resistor values are generally used.

Figure 67 shows the AD8137 in a unity-gain configuration, and with the following discussion, provides a good example of how to provide a proper termination in a 50  $\Omega$  environment.

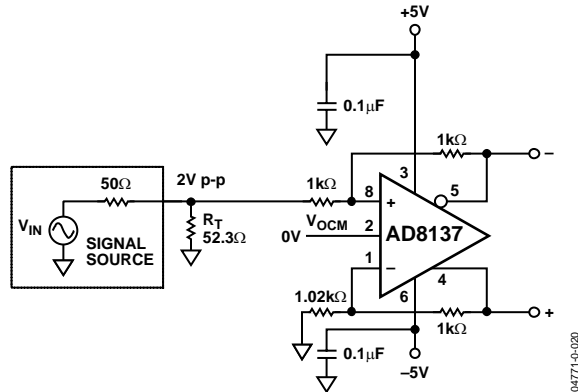

Figure 67. AD8137 with Terminated Input

The 52.3  $\Omega$  termination resistor,  $R_T$ , in parallel with the 1 k $\Omega$  input resistance of the AD8137 circuit, yields an overall input resistance of 50  $\Omega$  that is seen by the signal source. To have matched feedback loops, each loop must have the same  $R_G$  if it has the same  $R_F$ . In the input (upper) loop,  $R_G$  is equal to the 1 k $\Omega$  resistor in series with the (+) input plus the parallel combination of  $R_T$  and the source resistance of 50  $\Omega$ . In the upper loop,  $R_G$  is therefore equal to 1.03 k $\Omega$ . The closest standard value is 1.02 k $\Omega$  and is used for  $R_G$  in the lower loop.

Things become more complicated when it comes to determining the feedback resistor values. The amplitude of the signal source generator  $V_{IN}$  is two times the amplitude of its output signal when terminated in 50  $\Omega$ . Therefore, a 2 V p-p terminated amplitude is produced by a 4 V p-p amplitude from  $V_S$ . The Thevenin equivalent circuit of the signal source and  $R_T$  must be used when calculating the closed-loop gain because  $R_G$  in the upper loop is split between the 1 k $\Omega$  resistor and the Thevenin resistance looking back toward the source. The Thevenin voltage of the signal source is greater than the signal source output voltage when terminated in 50  $\Omega$  because  $R_T$  must always be greater than 50  $\Omega$ . In this case,  $R_T$  is 52.3  $\Omega$  and the Thevenin voltage and resistance are 2.04 V p-p and 25.6  $\Omega$ , respectively.

Now the upper input branch can be viewed as a 2.04 V p-p source in series with 1.03 k $\Omega$ . Because this is to be a unity-gain application, a 2 V p-p differential output is required, and  $R_F$  must therefore be  $1.03 \text{ k}\Omega \times (2/2.04) = 1.01 \text{ k}\Omega \approx 1 \text{ k}\Omega$ .

This example shows that when  $R_F$  and  $R_G$  are large compared to  $R_T$ , the gain reduction produced by the increase in  $R_G$  is essentially cancelled by the increase in the Thevenin voltage caused by  $R_T$  being greater than the output resistance of the signal source. In general, as  $R_F$  and  $R_G$  become smaller in terminated applications,  $R_T$  needs to be increased to compensate for the increase in  $R_G$ .

When generating the typical performance characteristics data, the measurements were calibrated to take the effects of the terminations on closed-loop gain into account.

## Power-Down

The AD8137 features a  $\overline{\text{PD}}$  pin that can be used to minimize the quiescent current consumed when the device is not being used.  $\overline{\text{PD}}$  is asserted by applying a low logic level to Pin 7. The threshold between high and low logic levels is nominally 1.1 V above the negative supply rail. See Table 1 to Table 3 for the threshold limits.

The AD8137  $\overline{\text{PD}}$  pin features an internal pull-up network that enables the amplifier for normal operation. The AD8137  $\overline{\text{PD}}$  pin can be left floating (that is, no external connection is required) and does not require an external pull-up resistor to ensure normal on operation (see Figure 68).

Do not connect the  $\overline{\text{PD}}$  pin directly to  $V_{S+}$  in  $\pm 5$  V applications. This can cause the amplifier to draw excessive supply current (see Figure 59) and may induce oscillations and/or stability issues.

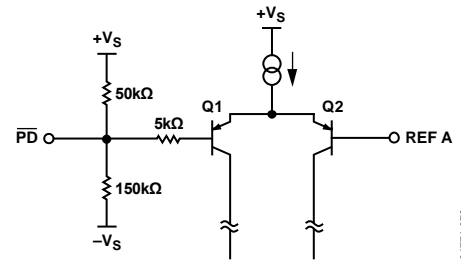

Figure 68.  $\overline{\text{PD}}$  Pin Circuit

## DRIVING AN ADC WITH GREATER THAN 12-BIT PERFORMANCE

Because the AD8137 is suitable for 12-bit systems, it is desirable to measure the performance of the amplifier in a system with greater than 12-bit linearity. In particular, the effective number of bits (ENOB) is most interesting. The AD7687, 16-bit, 250 KSPS ADC performance makes it an ideal candidate for showcasing the 12-bit performance of the AD8137.

For this application, the AD8137 is set in a gain of 2 and driven single-ended through a 20 kHz band-pass filter, while the output is taken differentially to the input of the AD7687 (see Figure 69). This circuit has mismatched  $R_G$  impedances and, therefore, has a dc offset at the differential output. It is included as a test circuit to illustrate the performance of the AD8137. Actual application circuits should have matched feedback networks.

For an AD7687 input range up to  $-1.82$  dBFS, the AD8137 power supply is a single 5 V applied to  $V_{S+}$ , with  $V_{S-}$  tied to ground. To increase the AD7687 input range to  $-0.45$  dBFS, the AD8137 supplies are increased to +6 V and  $-1$  V. In both cases, the  $V_{OCM}$  pin is biased with 2.5 V and the  $\overline{\text{PD}}$  pin is left floating. All voltage supplies are decoupled with 0.1  $\mu\text{F}$  capacitors. Figure 70 and Figure 71 show the performance of the  $-1.82$  dBFS setup and the  $-0.45$  dBFS setup, respectively.

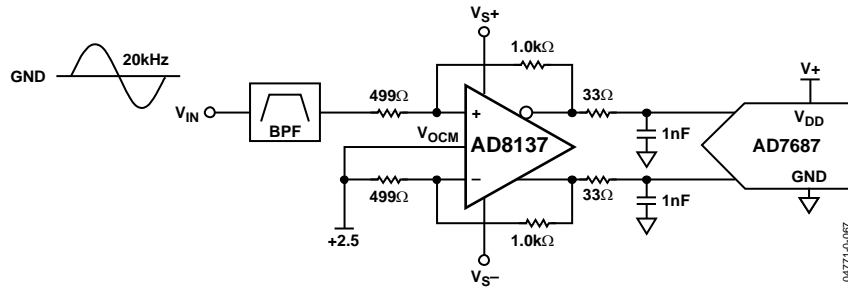

Figure 69. AD8137 Driving AD7687, 16-Bit 250 KSPS ADC

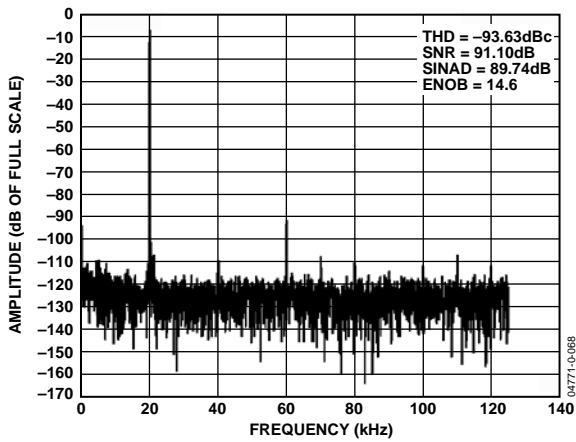

Figure 70. AD8137 Performance on Single 5 V Supply, -1.82 dBFS

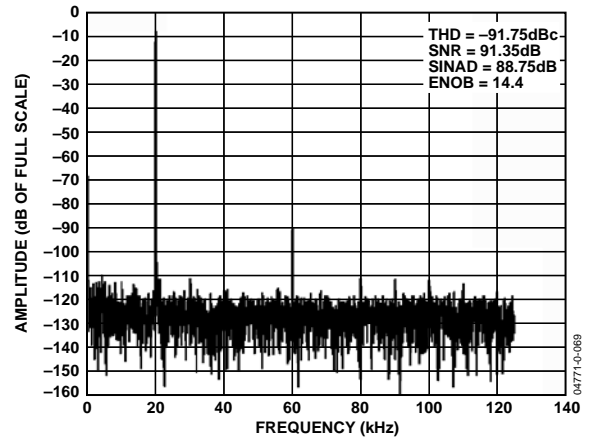
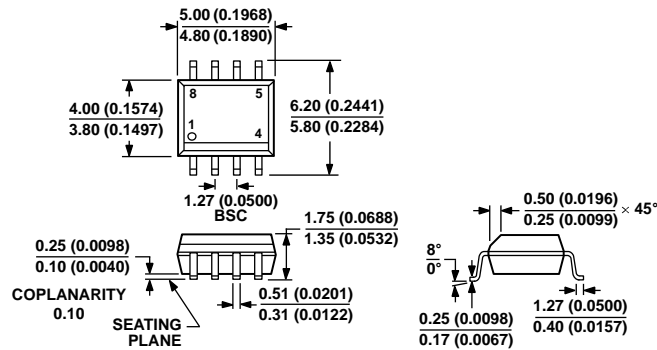

Figure 71. AD8137 Performance on +6 V, -1 V Supplies, -0.45 dBFS

OUTLINE DIMENSIONS



COMPLIANT TO JEDEC STANDARDS MS-012-AA  
 CONTROLLING DIMENSIONS ARE IN MILLIMETERS; INCH DIMENSIONS  
 (IN PARENTHESES) ARE ROUNDED-OFF MILLIMETER EQUIVALENTS FOR  
 REFERENCE ONLY AND ARE NOT APPROPRIATE FOR USE IN DESIGN.

012407-A

Figure 72. 8-Lead Standard Small Outline Package [SOIC\_N]  
 Narrow Body  
 (R-8)

Dimensions shown in millimeters and (inches)

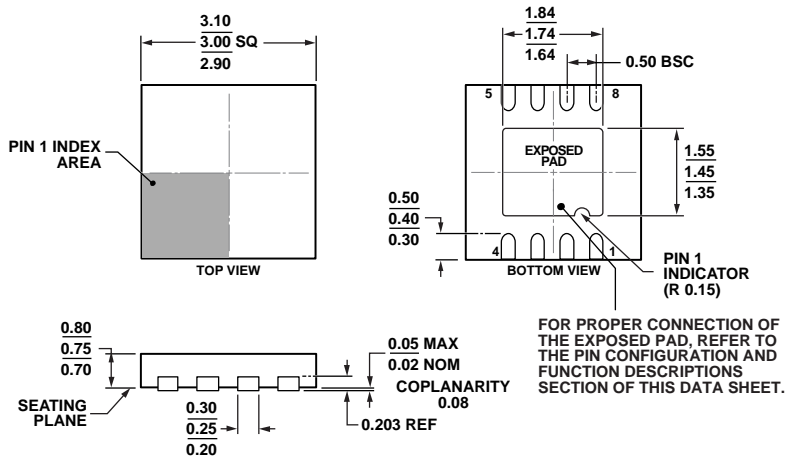

12-07-2010A

COMPLIANT TO JEDEC STANDARDS MO-229-WEED  
 Figure 73. 8-Lead Lead Frame Chip Scale Package [LFCSF\_WD]  
 3 mm x 3 mm Body, Very Very Thin, Dual Lead  
 (CP-8-13)

Dimensions shown in millimeters

**ORDERING GUIDE**

Model <sup>1, 2</sup>	Temperature Range	Package Description	Package Option	Branding
AD8137YR	–40°C to +125°C	8-Lead Standard Small Outline Package (SOIC_N)	R-8	
AD8137YR-REEL7	–40°C to +125°C	8-Lead Standard Small Outline Package (SOIC_N)	R-8	
AD8137YRZ	–40°C to +125°C	8-Lead Standard Small Outline Package (SOIC_N)	R-8	
AD8137YRZ-REEL	–40°C to +125°C	8-Lead Standard Small Outline Package (SOIC_N)	R-8	
AD8137YRZ-REEL7	–40°C to +125°C	8-Lead Standard Small Outline Package (SOIC_N)	R-8	
AD8137YCPZ-R2	–40°C to +125°C	8-Lead Lead Frame Chip Scale Package (LFCSP_WD)	CP-8-13	HFB#
AD8137YCPZ-REEL	–40°C to +125°C	8-Lead Lead Frame Chip Scale Package (LFCSP_WD)	CP-8-13	HFB#
AD8137YCPZ-REEL7	–40°C to +125°C	8-Lead Lead Frame Chip Scale Package (LFCSP_WD)	CP-8-13	HFB#
AD8137WYCPZ-R7	–40°C to +125°C	8-Lead Lead Frame Chip Scale Package (LFCSP_WD)	CP-8-13	H2G
AD8137YCP-EBZ		LFCSP Evaluation Board		
AD8137YR-EBZ		SOIC Evaluation Board		

<sup>1</sup> Z = RoHS Compliant Part; # denotes that RoHS part may be top or bottom marked.

<sup>2</sup> W = Qualified for Automotive Applications.

**AUTOMOTIVE PRODUCTS**

The AD8137W models are available with controlled manufacturing to support the quality and reliability requirements of automotive applications. Note that these automotive models may have specifications that differ from the commercial models; therefore, designers should review the Specifications section of this data sheet carefully. Only the automotive grade products shown are available for use in automotive applications. Contact your local Analog Devices account representative for specific product ordering information and to obtain the specific Automotive Reliability reports for these models.

**NOTES**



**NOTES**