

18000 series

Snap-action momentary pushbutton switches

Distinctive features and specifications

UG1006-A



- Panel and PC mount models
- Snap-in panel mounting version
- Tactile feedback

B

ELECTRICAL SPECIFICATIONS

- Max. current/voltage rating with resistive load :
 - gold plated brass contacts : 100mA - 30VDC
 - gold plated silver contacts : 1A 125VAC, 1A 30VDC
 - Initial contact resistance : 50 mΩ max.
 - Insulation resistance : 1.000 MΩ min.
 - Dielectric strength : 1.000 Vrms 50 Hz min.
 - Electrical life : 60.000 cycles at full load
- Models for high currents : see 18635A and 18645A at the end of the series.

MATERIALS

- Case : PBT
- Actuator : polyamide, glass filled
- Bushing : brass, nickel plated
- Housing : stainless steel
- Bracket : tin plated steel
- Contacts
 - AD** : silver, gold plated
 - CD** : brass, gold plated
- Terminal seal : epoxy

GENERAL SPECIFICATIONS

- Total travel : 0,5 mm (.019)
- Torque : 1,25 Nm (.922 Ft.lb) max. applied to nut
- Operating temperature : -30°C to +65°C
- Soldering : 300°C, 3 sec. max.



18000 series

Snap-action momentary pushbutton switches

Overview

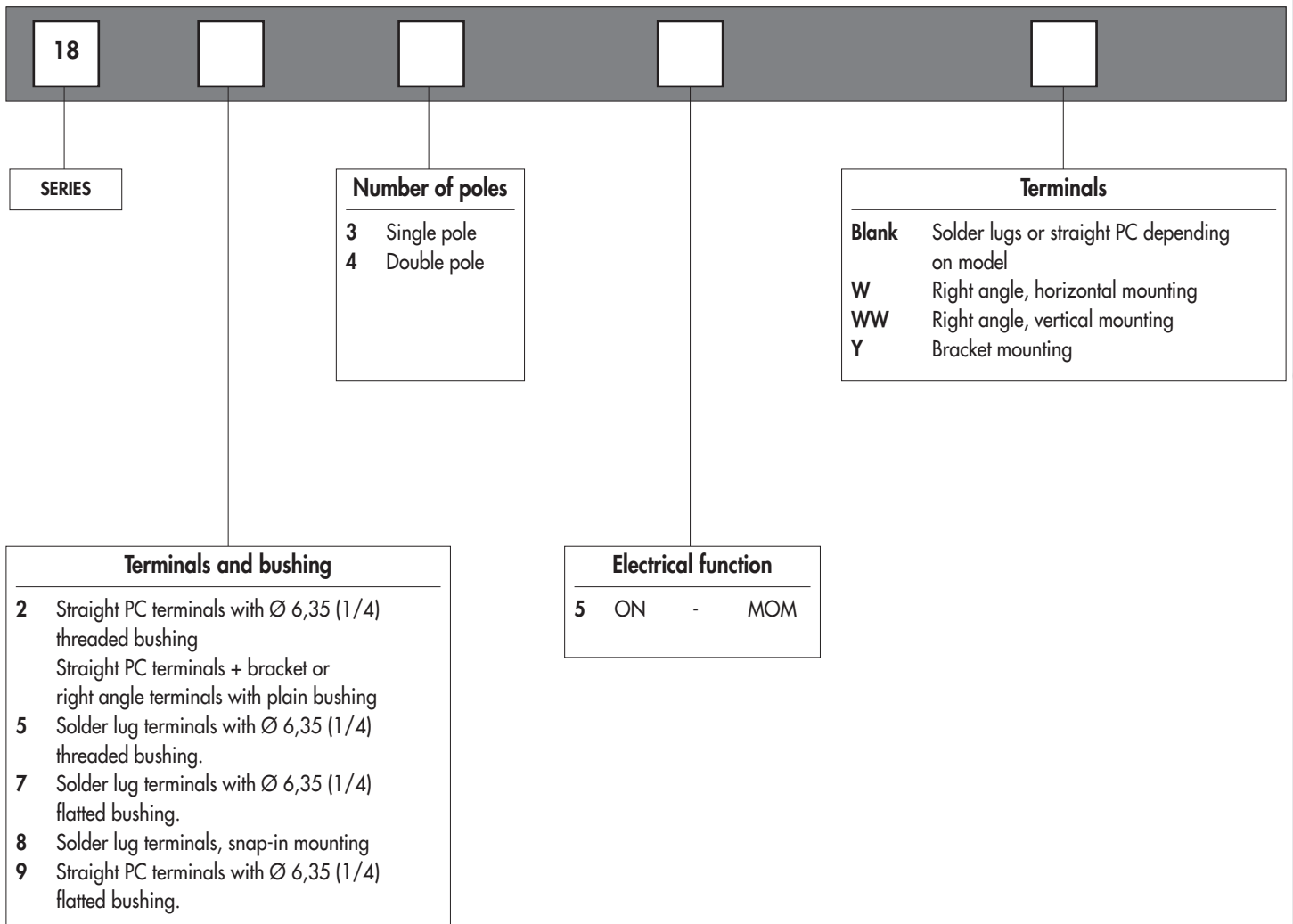

ABOUT THIS SERIES

On the following pages, you will find successively :

- model structure of switches
- options in the same order as in above chart

Dimensions : first dimensions are in mm while inches are shown as bracketed numbers.



NOTICE : please note that not all combinations of above numbers are available. Refer to the following pages for further information.

18000 series

Snap-action momentary pushbutton switches



Overview

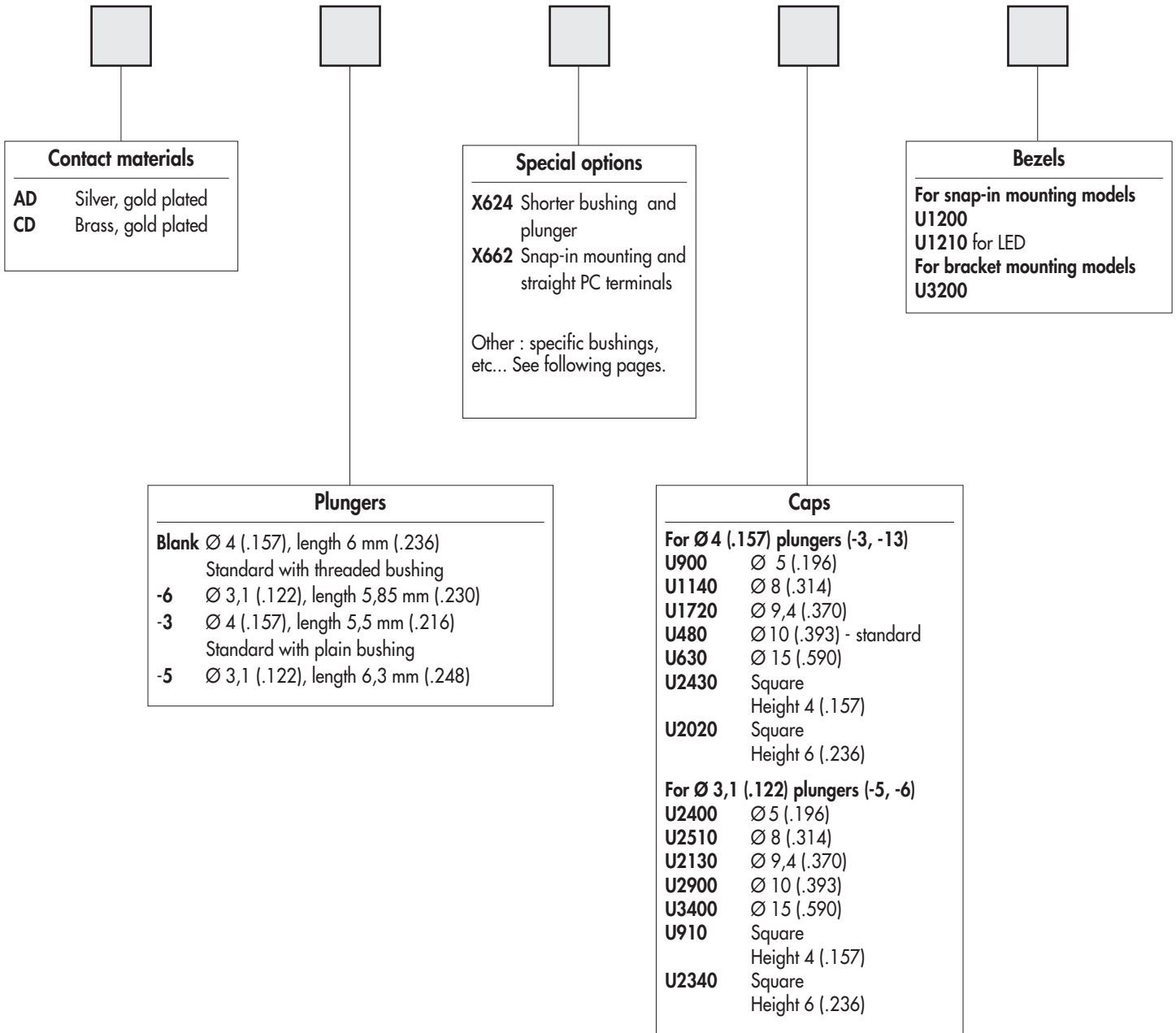

B



Sealing boots are available to protect the switches against dust and water. They are presented in section H.



Mounting accessories : standard hardware supplied with all models with Ø 6,35 (1/4) threaded bushing : 2 hex nuts 8 mm (.314) across flats, 1 locking ring and 1 lockwasher. Standard and special hardware available are presented in section I.



Packaging unit : 25 pieces for W, WW double pole and 18800 models
50 pieces for other models.



18000 series

Snap-action momentary pushbutton switches

Threaded bushing $\varnothing 6,35$ (1/4) : 18500 - 18700 - 18200

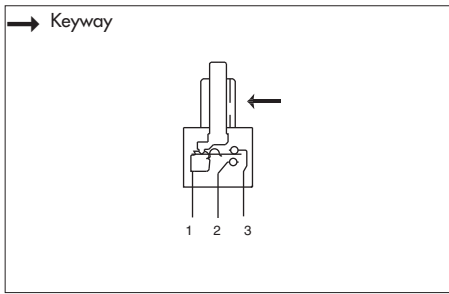

- Solder lug or straight PC terminals
- Epoxy sealed terminals standard

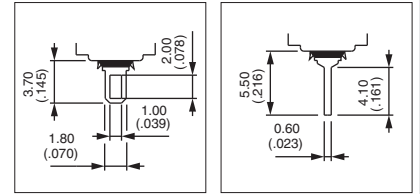

MODEL STRUCTURE

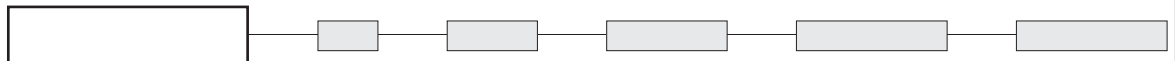

Shown with standard plunger

B

Solder lug terminals : 18500

→ Keyway



Single pole
18535

Double pole
18545



1-3

ON



1-2

MOM

ON

MOM

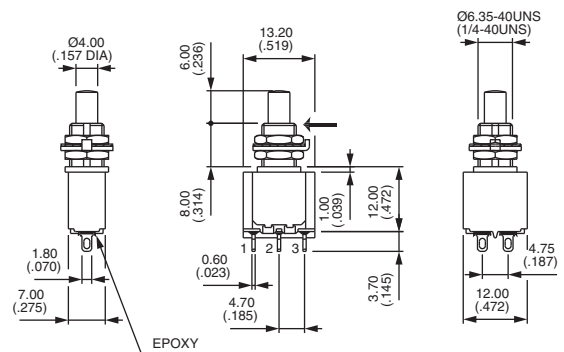

Flatted bushing - solder lug terminals : 18700

→ Flat



Single pole
18735

Double pole
18745



1-3

ON



1-2

MOM

ON

MOM

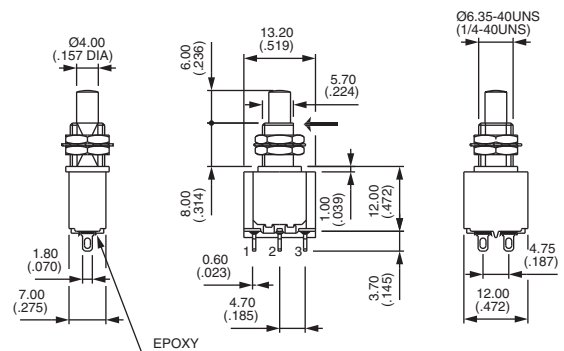

Straight PC terminals : 18200

→ Keyway



Single pole
18235

Double pole
18245



1-3

ON



1-2

MOM

ON

MOM

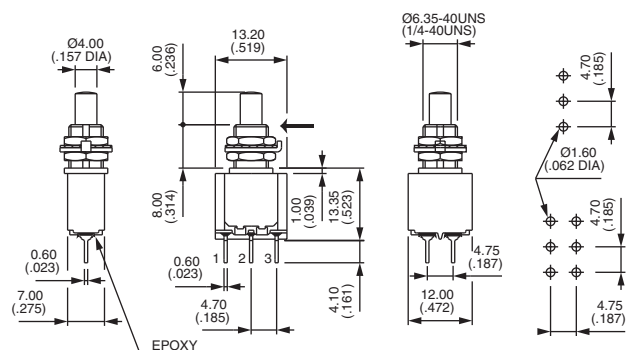

18000 series

Snap-action momentary pushbutton switches

Threaded bushing $\varnothing 6,35$ (1/4) : 18900 - Snap-in mounting : 18800

MODEL
STRUCTURE

Flatted bushing - straight PC terminals : 18900

→ Flat



Single pole
18935

Double pole
18945



1-3

ON



1-2

MOM

ON

MOM

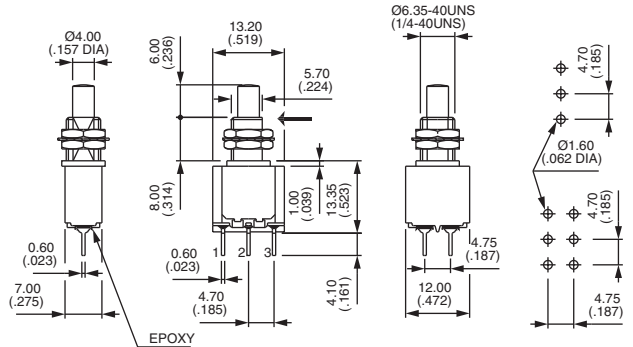

Snap-in mounting - solder lug terminals : 18800

Shown with cap U910 + U1200



Single pole
18835

Double pole
18845



1-3

ON



1-2

MOM

ON

MOM

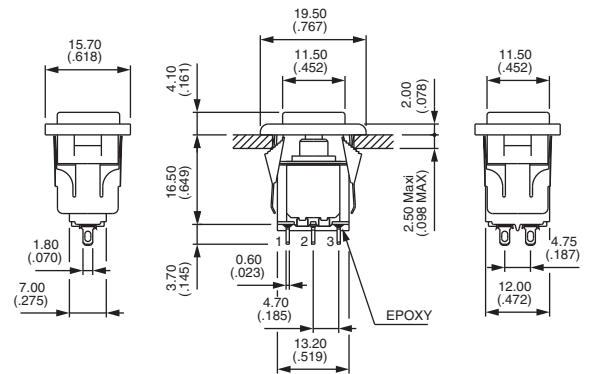

Available with straight PC terminals : see X662 under "Special options".

PANEL CUT-OUT

18500 - 18200

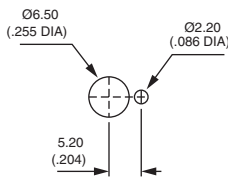

18700 - 18900

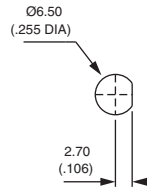

PANEL CUT-OUT

18800

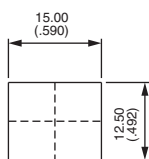

With bezel **U1200**

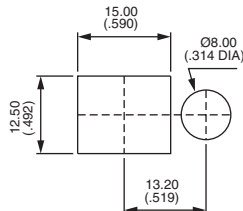

With bezel **U1210** for LED

B

18000 series

Snap-action momentary pushbutton switches



Right angle terminals - vertical : 18200WW



Single pole
18235WW

Double pole
18245WW

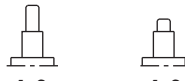

1-3	1-2
ON	MOM
ON	MOM

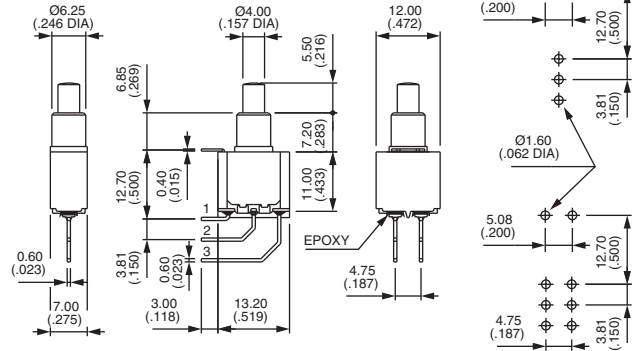

B

CONTACT MATERIALS



AD Silver, gold plated
CD Brass, gold plated

PLUNGERS



Dash compulsory before plunger code.

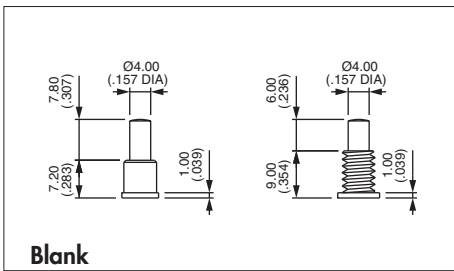

Blank

Ø 4 (.157) - standard with threaded bushing

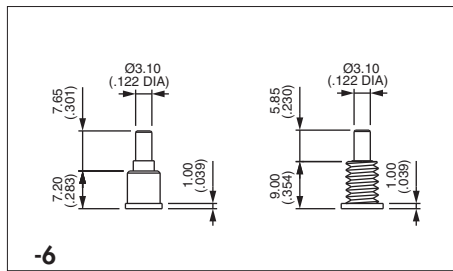

-6

Ø 3,1 (.122)

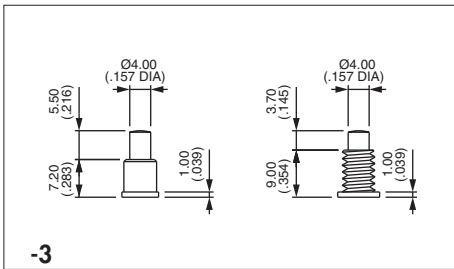

-3

Ø 4 (.157) - standard with plain bushing

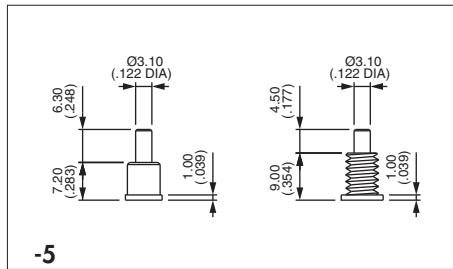

-5

Ø 3,1 (.122)



18000 series

Snap-action momentary pushbutton switches



SPECIAL OPTIONS





X624 Straight PC terminals - bracket mounting - with shorter bushing and plunger



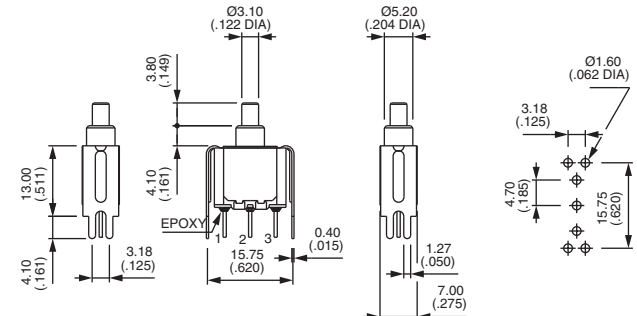

Single pole
18235Y -2X624

ON  MOM 





Double pole
18245Y -2X624

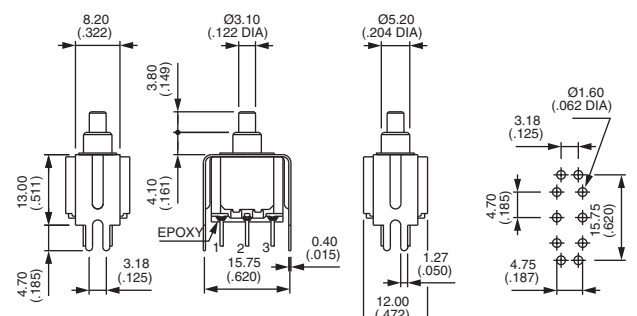

ON  MOM 





X662 Snap-in mounting - straight PC terminals



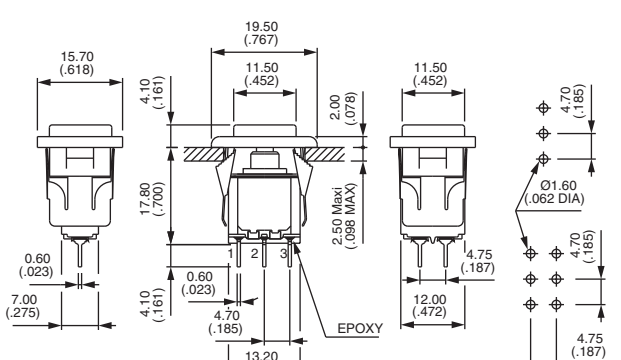

Single pole
18835 X662

ON  MOM 





Double pole
18845 X662

ON  MOM 

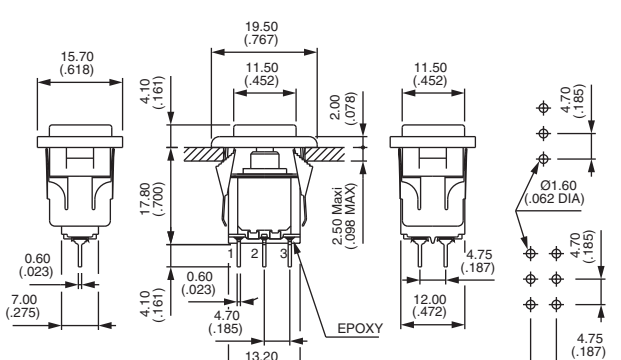

18000 series

Snap-action momentary pushbutton switches

OPTIONS



SPECIAL OPTIONS (continued)



X371 Plain bushing \varnothing 6,25 mm (.246) (instead of standard threaded bushing).

X372 Shorter threaded bushing \varnothing 6,35 (1/4). Height 7 mm (.274).

X386 Threaded bushing \varnothing 6,35 mm (1/4) to replace plain bushing on models W - WW and Y.

X438 Plain bushing \varnothing 6,25 mm (.246). Height 7,2 mm (.283) - without shoulder.

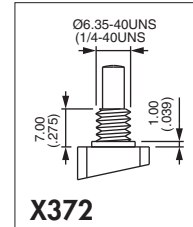

X372

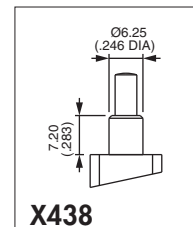

X438

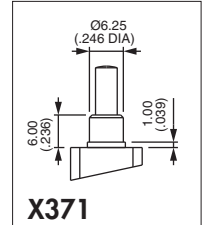

X371

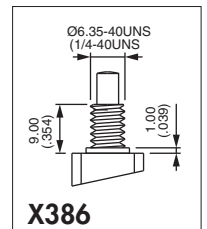

X386

CAPS

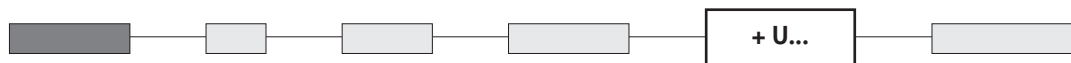

Caps for \varnothing 4 (.157) plungers (-13, -3)

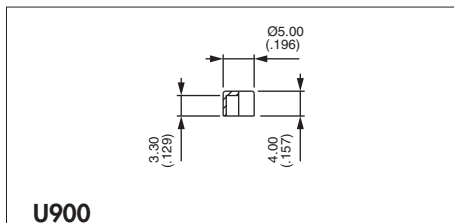

U900

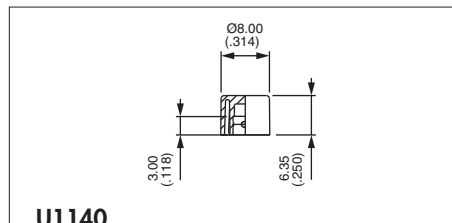

U1140

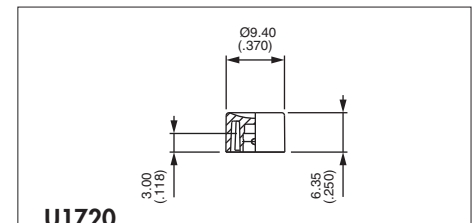

U1720

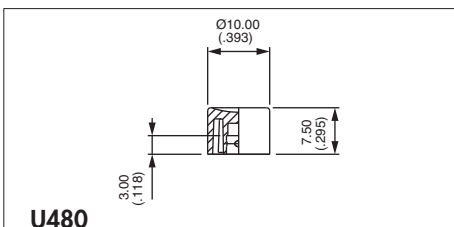

U480

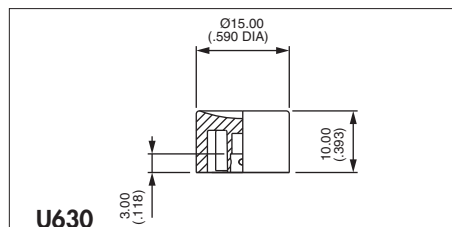

U630

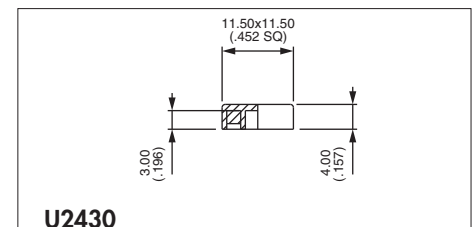

U2430

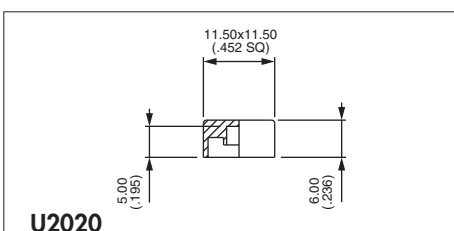

U2020

Square

Square

Cap colours

Replace last "0" by number

1	blue	5	yellow
1/4	dark blue	6	red
2	black	7	ivory
3	green	7/1	white
4	grey	9	orange



18000 series

Snap-action momentary pushbutton switches

CAPS (continued)

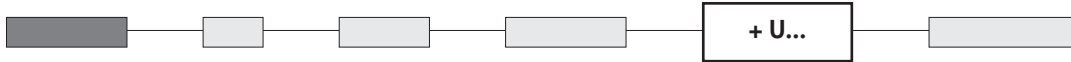

Caps for Ø 3,1 (.122) plungers (-5, -6)

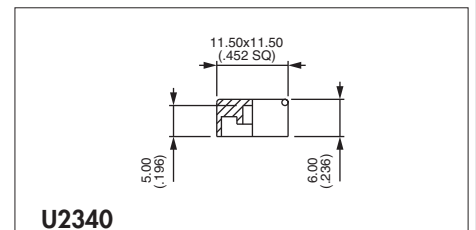
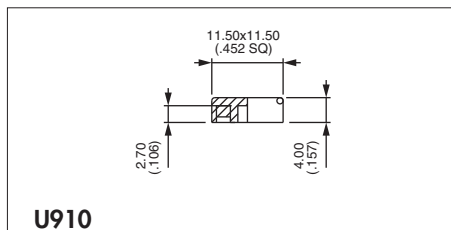
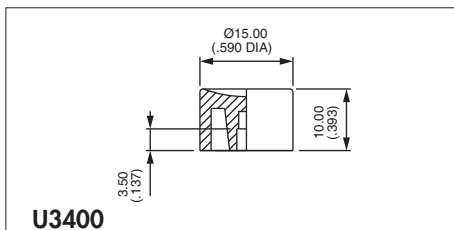
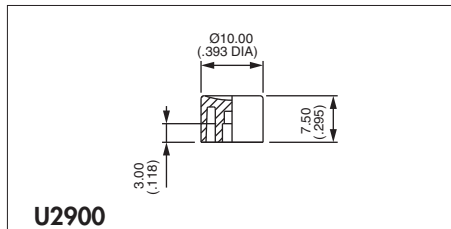
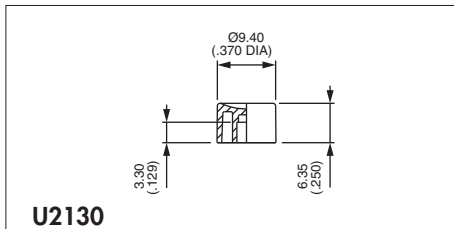
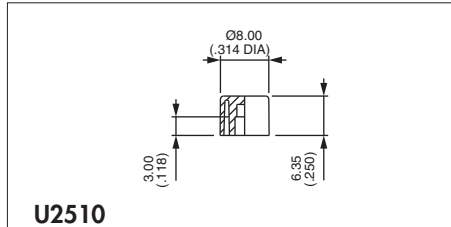
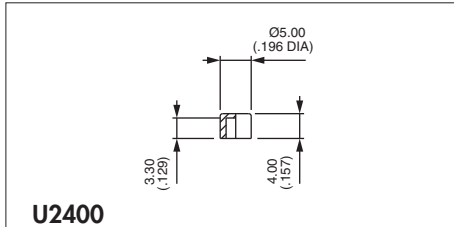

Cap colours	
Replace "0" by number	
1	blue
1/4	dark blue
2	black
3	green
4	grey
5	yellow
6	red
7	ivory
7/1	white
9	orange

Square

Square

Caps for 18800 and 18800X662 models

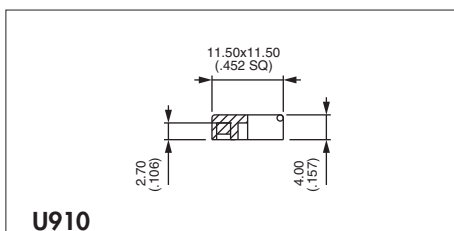

Square

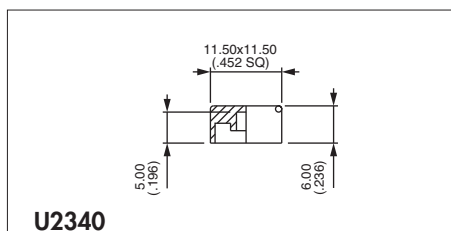

Square

18000 series

Snap-action momentary pushbutton switches

OPTIONS



DRESS NUTS

For models with threaded bushing (18500 - 18700 - 18200 - 18900)

Chrome plated - Order separately.

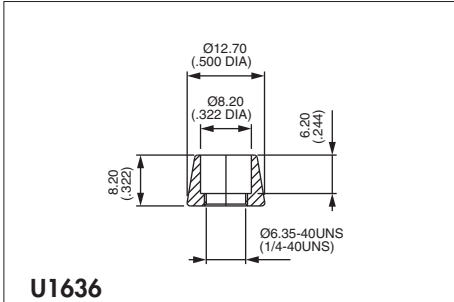

U1636

For caps U1140 and U2510

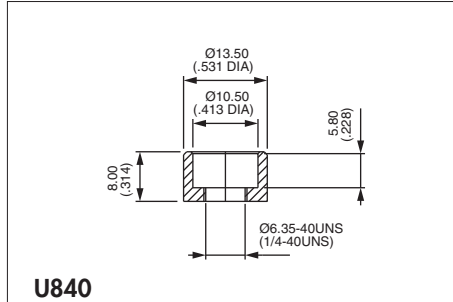

U840

For cap U480 and U2900

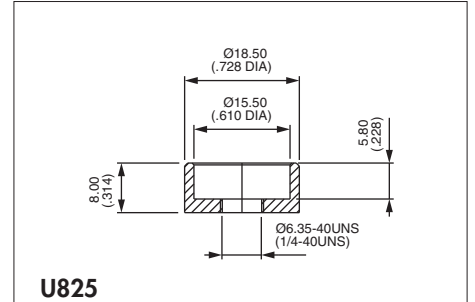

U825

For caps U630 and U3400

BEZELS



For snap-in models (18800 - 18800X662)

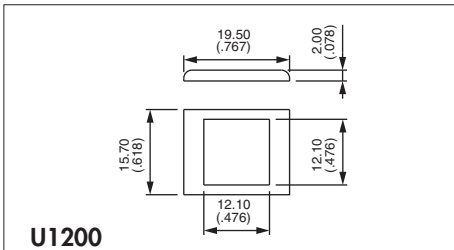

U1200

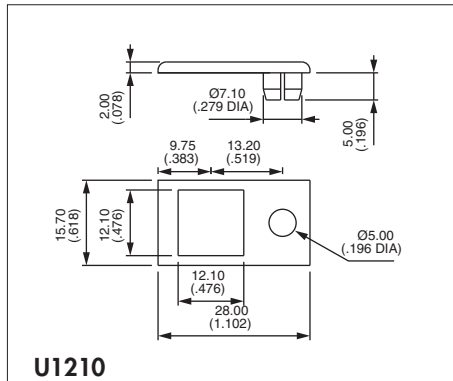

U1210

For LED Ø 5 - not supplied

Bezel colours

Replace last "0" by number

- 1 blue
- 1/4 dark blue
- 2 black
- 3 green
- 4 grey
- 5 yellow
- 6 red
- 7 ivory
- 7/1 white
- 9 orange

For bracket mounting models (18200Y & 18200YX624)

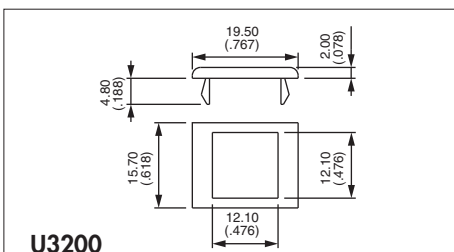

U3200

STANDARD PANEL MOUNTING

Panel thickness with bezel : 1 mm (.039) to 2,5 mm (.098)

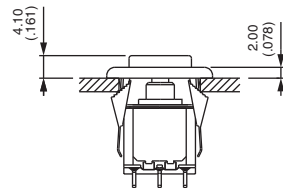

18800 + U910 + U1200

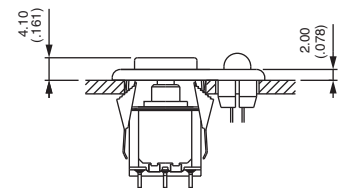

18800 + U910 + U1210

18000 series

Snap-action momentary pushbutton switches



For high currents

Tactile feedback

ELECTRICAL SPECIFICATIONS

- Max. current/voltage rating with resistive load :
3A 250VAC - 6A 125VAC - 7A 30VDC
- Initial contact resistance : 20 m Ω max. at 0,1A 3VDC
- Insulation resistance : 200.000 M Ω min. between terminals and frame
- Dielectric strength : 1.500 Vrms 50 Hz min.
- Electrical life : 60.000 cycles at full load

GENERAL SPECIFICATIONS

- Travel : 0,90 mm (.035) approx.
- Operating temperature :
-30°C to +85°C

MATERIALS

- Case : diallylphthalate (DAP)
- Actuator : glass filled polyester
- Bushing : brass, nickel plated
- Housing : stainless steel
- Contacts : silver
- Terminal seal : epoxy

B

18000 series

Snap-action momentary pushbutton switches

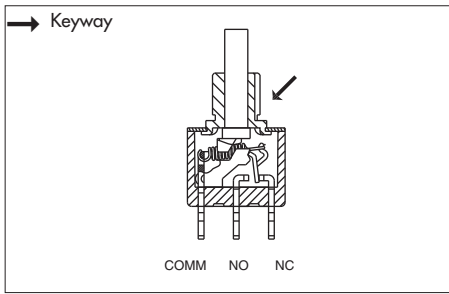

- Threaded bushing $\varnothing 6,35$ (1/4)
- Solder lug terminals
- Epoxy sealed terminals

MODEL STRUCTURE



B

Single pole



18635A

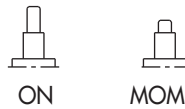

→ Keyway

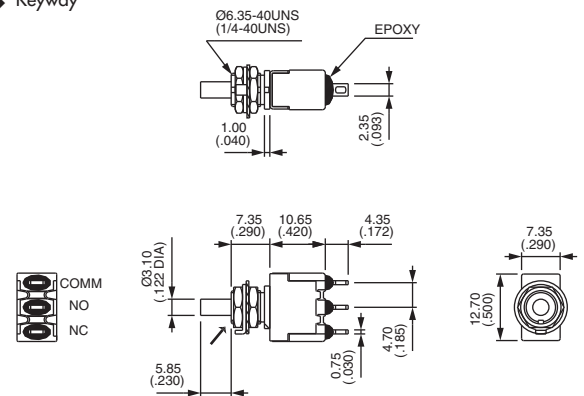

Double pole



18645A

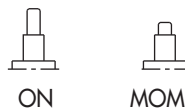

→ Keyway

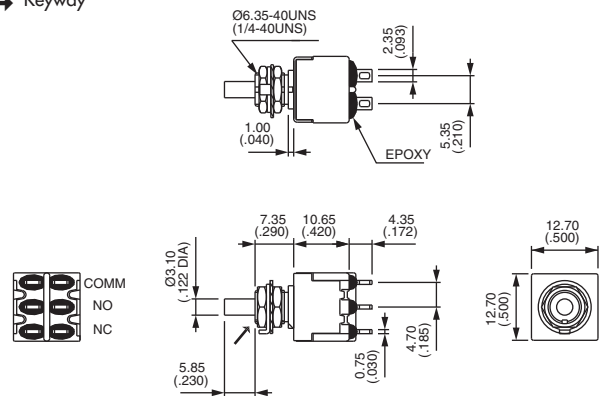

CAPS



Round

U2400	$\varnothing 5$ (.196)
U2510	$\varnothing 8$ (.314)
U2130	$\varnothing 9,4$ (.370)
U2900	$\varnothing 10$ (.393)
U3400	$\varnothing 15$ (.590)

Square

U910	Height 4 (.157)
U2340	Height 6 (.236)

PANEL CUT-OUT

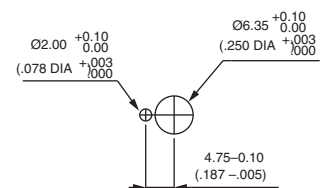

For cap dimensions, see "Caps for $\varnothing 3,1$ (.122) plungers" on the preceding pages.