

# C-Series Circuit Breaker

The C-Series hydraulic/magnetic circuit breakers are ideal for applications that require higher amperage and voltage handling capability in a smaller package. They are available in 1-6 poles, 0.02-100amps, UL Recognized up to 480VAC or 150VDC, UL489 Listed up to 240VAC or 125VDC, with choice of time delays, terminal options, actuator styles and colors.

## Product Highlights:

- The UL489 C-Series employs a unique arc chute design which allows for higher interrupting capacities of up to 10,000 amps. New thermoset glass filled polyester half shell construction provides for increased mechanical and electrical strength. The wiping contacts, mechanical linkage with two step actuation, clean contacts providing high, positive contact pressure and longer contact life
- Available with American Standard or Metric Threaded Stud terminals, or Saddle Clamp screw terminals. Optional mid-trip handle style actuator allows visual indication of electrical overload with or without alarm feature
- Available with new solid color rocker actuators and unique two-color Visi-rocker® actuators, which can be specified to indicate either the ON or TRIPPED/OFF mode
- Exclusive Rockerguard and Push-To-Reset bezel help prevent inadvertent actuation



HANDLE ACTUATOR



METAL TOGGLE ACTUATOR



PARALLEL POLE ACTUATOR

## Agency Certifications:

UL Recognized  
UL Standard 1077 | UL Standard 508  
UL Standard 1500  
UL Listed  
UL Standard 489 | UL Standard 489A  
CSA Accepted | CSA Certified  
TUV Certified | VDE Certified

\* For full Agency Certifications, please see pg. 6



**Carling Technologies®**

Innovative Designs. Powerful Solutions.

Innovative Designs. Powerful Solutions.

Carling Technologies, Inc.  
60 Johnson Avenue • Plainville, CT 06062-1177  
Phone: (860) 793-9281 • Fax: (860) 793-9231  
Email: [sales@carlingtech.com](mailto:sales@carlingtech.com) • [www.carlingtech.com](http://www.carlingtech.com)

## Electrical Tables

**Table A:** Lists UL Recognized & CSA Accepted configurations and performance capabilities as a Component Supplementary Protector

C-SERIES TABLE A: COMPONENT SUPPLEMENTARY PROTECTORS											
CIRCUIT CONFIGURATION	VOLTAGE			CURRENT RATING		SHORT CIRCUIT CAPACITY (AMPS)		APPLICATION CODES		NOTES	
	MAX. RATING	FREQUENCY	PHASE	FULL LOAD AMPS	GENERAL PURPOSE AMPS	UL/CSA		UL	CSA		
						WITH BACKUP FUSE <sup>1</sup>	WITHOUT BACKUP FUSE				
SERIES	32	DC	—	0.02 - 100	—	—	5000	TC1, OL1, U2	TC1, OL1, U2		
	48	DC	—	110 - 150	—	—	5000	TC1, OL1, U2	TC1, OL1, U2	Must Have Agency Code "L"	
	65	DC	—	0.02 - 70	—	—	5000	TC1,2, OL1,U1	TC1,2, OL1,U1		
				—	71 - 100	—	5000	TC1,2, OL0,U1	TC1,2, OL0,U1		
	80	DC	—	0.02 - 70	—	—	7500	TC1,2, OL1,U1	TC1,2, OL1,U1		
				—	71 - 100	—	7500	TC1,2, OL0,U1	TC1,2, OL0,U1		
	80	DC	—	0.02 - 70	—	—	10,000	TC1,2, OL1,U1	TC1,2, OL1,U1	Must Have Agency Code "L"	
				—	71 - 100	—	10,000	TC1,2, OL0,U1	TC1,2, OL0,U1	Must Have Agency Code "L"	
	125	DC	—	0.02 - 50	—	—	5000	TC1,2,OL1,U1	TC1,2,OL1,U1	Must Have Agency Code "L"	
	125 / 250	DC	—	0.02 - 50	—	—	5000	TC1,2,OL1,U1	TC1,2,OL1,U1	Must Have Agency Code "L"	
	250	DC	—	0.02 - 50	—	—	5000	TC1,2,OL1,U1	TC1,2,OL1,U1	Must Have Agency Code "L", 2 Pole Break Required for 250 Volts	
	125	50 / 60	1	0.02 - 100	—	—	3000	TC1, OL1, U2	TC1, OL1, U2	Per Pole Rating	
				0.02 - 100	—	—	5000	TC1,2,OL1,U1	TC1,2,OL1,U1	Must Have Agency Code "L"	
	150	DC	—	—	80-100	—	5000	TC1, OLO, U3	—	Agency Code "L"	
	150	DC	—	—	101-175	—	5000	TC, OLO, U3	—	Agency Code "L" Parallel Pole	
	125 / 250	50 / 60	1	0.02 - 100	—	—	3500	TC1, OL1, U2	TC1, OL1, U2		
				0.02 - 50	—	—	3000	TC1,2,OL1,U1	TC1,2,OL1,U1	2 or 3 poles breaking single phase	
				51 - 100	—	—	1000	TC1,2,OL1,U1	TC1,2,OL1,U1	2 or 3 poles breaking single phase	
				0.02 - 100	—	—	5000	TC1,1,OL1,U2	TC1,1,OL1,U2	2 or 3 poles breaking single phase, "L" Agency Code	
		250	50 / 60	1	0.02 - 50	—	—	3500	TC1, OL1, U2	TC1, OL1, U2	Per Pole Rating
					0.02 - 100	—	—	5000	TC1,2,OL1,U1	TC1,2,OL1,U1	Must Have Agency Code "L"
					51 - 70	—	5000	—	TC1,2,OL1,C1	TC1,2,OL1,C1	
					0.02 - 100	—	—	3000	TC1, OL0, U2	TC1, OL0, U2	
				3	0.02 - 70	—	5000	—	TC1,2,OL1,C1	TC1,2,OL1,C1	3 poles breaking 3 phase
0.02 - 90					—	—	5000	TC1,2,OL1,U1	TC1,2,OL1,U1	Must Have Agency Code "L"	
0.02 - 50					—	5000	—	TC1,2,OL1,C1	TC1,2,OL1,C1	3 poles breaking 3 phase	
0.02 - 30					—	5000	—	TC1,2,OL0,C1	TC1,2,OL0,C1	2 poles breaking 1 phase	
277	50 / 60	1	0.02 - 50	—	5000	—	TC1,2,OL1,C1	TC1,2,OL1,C1	3 poles breaking 3 phase		
480 / 277	50 / 60	3	0.02 - 30	—	5000	—	TC1,2,OL0,C1	TC1,2,OL0,C1	3 poles breaking 3 phase		
480	50 / 60	1	0.02 - 30	—	5000	—	TC1,2,OL0,C1	TC1,2,OL0,C1	2 poles breaking 1 phase		
DUAL COIL	80	DC	—	0.02 - 50	—	—	7500	TC1,2, OL1,U1	TC1,2, OL1,U1		
	125	50 / 60	1	0.02 - 50	—	—	3000	TC1, OL1, U2	TC1, OL1, U2	Per Pole Rating	
	125 / 250	50 / 60	1	0.02 - 50	—	—	3500	TC1, OL1, U2	TC1, OL1, U2	2 or 3 poles breaking single phase	
				0.02 - 50	—	—	3000	TC1,2,OL1,U1	TC1,2,OL1,U1	2 or 3 poles breaking single phase	
	250	50 / 60	3	0.02 - 50	—	—	3500	TC1, OL1, U2	TC1, OL1, U2	Per Pole Rating	
				0.02 - 50	—	—	3000	TC1, OL0, U2	TC1, OL0, U2	3 poles breaking 3 phase	
277	50 / 60	1	0.02 - 50	—	5000	—	TC1,2,OL1,C1	TC1,2,OL1,C1	3 poles breaking 3 phase		
SHUNT	80	DC	—	0.02 - 50	—	—	7500	TC1,2, OL1,U1	TC1,2, OL1,U1		
	277	50 / 60	1	0.02 - 50	—	5000	—	TC1,2,OL1,C1	TC1,2,OL1,C1		
	250	50 / 60	3	0.02 - 50	—	5000	—	TC1,2,OL1,C1	TC1,2,OL1,C1	3 poles breaking 3 phase	
				0.02 - 30	—	5000	—	TC1,2,OL1,C1	TC1,2,OL1,C1	3 poles breaking 3 phase	
	480	50 / 60	1	0.02 - 30	—	5000	—	TC1,2,OL0,C1	TC1,2,OL0,C1	2 poles breaking 1 phase	
SWITCH ONLY	80	DC	—	0.02 - 50	—	—	7500	TC1,2, OL1,U1	TC1,2, OL1,U1		
	277	50 / 60	1	0.02 - 50	—	5000	—	TC1,2,OL1,C1	TC1,2,OL1,C1		
	250	50 / 60	3	0.02 - 50	—	5000	—	TC1,2,OL1,C1	TC1,2,OL1,C1	3 poles breaking 3 phase	
SWITCH ONLY	65	DC	—	0.02 - 70	—	—	—	—	—		
				—	71 - 100	—	—	—	—		
	80	DC	—	0.02 - 70	—	—	—	—	—		
				—	71 - 100	—	—	—	—		
	125	50 / 60	1	0.02 - 100	—	—	—	—	—		
	125 / 250	50 / 60	1	0.02 - 100	—	—	—	—	—	—	2 or 3 poles breaking single phase
				0.02 - 100	—	—	—	—	—	—	
	250	50 / 60	3	0.02 - 70	—	—	—	—	—	—	
0.02 - 50				—	—	—	—	—	—		
277	50 / 60	1	0.02 - 50	—	—	—	—	—			
480 / 277	50 / 60	3	0.02 - 30	—	—	—	—	—	3 poles breaking 3 phase		

Notes for Table A:

- <sup>1</sup> Requires branch circuit backup with a UL LISTED Type K5 or RK5 fuse rated 15A minimum and no more than 4 times full load amps not to exceed 125A for 50 Amp or less rating and not to exceed 175 for 51 through 100 Amp rating

\*Manufacturer reserves the right to change product specification without prior notice.

## Electrical Tables

**Table B:** Lists UL Recognized and CSA Accepted configurations and performance capabilities as a Manual Motor Controller.

C-SERIES TABLE B: MANUAL MOTOR CONTROLLERS					
CIRCUIT CONFIGURATION	VOLTAGE			CURRENT RATING	HORSEPOWER RATINGS
	MAX. RATING	FREQUENCY	PHASE	FULL LOAD AMPS	MAX HP
SERIES, SHUNT & RELAY SWITCH ONLY	120 <sup>1</sup>	50 / 60	1	0.02 - 50	7 1/2
	250 <sup>1</sup>	50 / 60	1	0.02 - 20	3
			3	0.02 - 20	5
	277 <sup>1</sup>	50 / 60	1	0.02 - 20	3
480 <sup>2</sup>	50 / 60	3	0.02 - 20	5	

Notes for Table B:

- 1 UL recognized and CSA Accepted at 480V refers to 3 & 4 pole versions used in a 3Ø, wye connected circuit or 2-pole version connected with 2 poles breaking. 1Ø and backed up with series fusing as stated above in note 1.
- \* Series, Shunt and Relay Trip - Voltage Coil Construction not current coils

**Table C:** Lists UL Recognized, CSA Accepted, VDE and TUV Certified configurations and performance capabilities as a Component Supplementary Protector.

C-SERIES TABLE C: COMPONENT SUPPLEMENTARY PROTECTORS																
CIRCUIT CONFIGURATION	VOLTAGE			CURRENT RATING		SHORT CIRCUIT CAPACITY (AMPS)						APPLICATION CODES		CONSTRUCTION NOTES		
	MAX. RATING	FREQUENCY	PHASE	FULL LOAD AMPS	GENERAL PURPOSE AMPS <sup>1</sup>	UL/CSA		VDE		TUV		UL	CSA			
						WITH BACKUP FUSE	WITHOUT BACKUP FUSE	(Inc) WITH BACKUP FUSE	(Icn) WITHOUT BACKUP FUSE	(Inc) WITH BACKUP FUSE	(Icn) WITHOUT BACKUP FUSE					
SERIES	80	DC	---	0.10 - 70	---	---	7500	---	5000	5000	1500	TC1,2, OL1,U1	TC1,2, OL1,U1			
			---	71 - 100	71-100	---	10,000	---	5000	---	5000	TC1,2, OL0,U1	TC1,2, OL0,U1	Agency Code F, H, J or R Only		
	125	DC	---	1 - 50	---	---	5000	---	---	---	5000	TC1,2, OL1,U1	TC1,2, OL1,U1	Agency Code J or R Only		
			---	0.10 - 50	---	---	5000	---	---	---	5000	TC1,2, OL1,U1	TC1,2, OL1,U1	Agency Code J or R Only, 2P		
	250	50 / 60	1	---	0.10 - 70	---	---	5000	3000	1500	3000	1500	TC1,2, OL1,U1	TC1,2, OL1,U1		
				---	0.10 - 100	---	---	5000	---	---	5000	5000	TC1,2, OL1,U1	TC1,2, OL1,U1	Agency Code J or R Only	
	415	50 / 60	3	---	0.10 - 90	---	---	5000	---	---	5000	5000	TC1,2, OL1,U1	TC1,2, OL1,U1	Agency Code J or R Only	
				---	0.10 - 30	---	---	5000	---	3000	1500	3000	1500	TC1,2, OL1,C1	TC1,2, OL1,C1	Rocker
DUAL COIL	80	DC	---	0.10 - 30	---	---	7500	---	1500	5000	1500	TC1,2, OL1,U1	TC1,2, OL1,U1			
			---	0.10 - 30	---	---	5000	3000	1500	3000	1500	TC1,2, OL1,U1	TC1,2, OL1,U1			
SHUNT	250	50 / 60	1 & 3	---	0.10 - 70	---	---	5000	3000	1500	3000	1500	TC1,2, OL1,U1	TC1,2, OL1,U1		
				---	0.10 - 30	---	---	5000	---	3000	1500	3000	1500	TC1,2, OL1,C1	TC1,2, OL1,C1	Rocker
SHUNT	415	50 / 60	3	---	0.10 - 30	---	---	5000	---	3000	1500	3000	1500	TC1,2, OL1,C1	TC1,2, OL1,C1	Handle/ Agency F, H, J, or R
				---	0.10 - 30	---	---	5000	---	5000	2500	3000	1500	TC1,2, OL1,C1	TC1,2, OL1,C1	Handle/ Agency F, H, J, or R

Notes for Table C:

- 1 General Purpose ratings for UL/CSA only.
- 2 Requires branch circuit backup with a UL LISTED Type K5 or RK5 fuse rated 15A minimum and no more than 4 times full load amps not to exceed 125A for 50 Amp or less rating and not to exceed 175 for 51 through 100 Amp rating.

## Electrical Tables

**Table D:** Lists UL Listed (489), CSA Certified (C22.2 No. 5.1-M) configuration and performance capabilities as a Molded Case Circuit Breaker.

C SERIES TABLE D : UL489 LISTED BRANCH CIRCUIT BREAKERS						
CIRCUIT CONFIGURATION	VOLTAGE			CURRENT RATING FULL LOAD AMPS	INTERRUPTING CAPACITY (AMPS) WITHOUT BACKUP FUSE	CONSTRUCTION NOTES
	MAX. RATING	FREQUENCY	PHASE			
SERIES	80	DC	---	0.10 - 100	50,000 <sup>1</sup> 10,000	Limited to 2 Poles Max from 71 - 100 Amps. Limited to 2 Poles Max from 71 - 100 Amps.
	125	DC	---	0.10 - 100	5,000	1 - 3 Poles
	125 / 250	DC	---	0.10 - 50	5,000	1 or 2 Poles (2 Poles Required for 250 Volts)
	120	50 / 60	1	0.10 - 50	10,000	1 - 3 Poles
				51 - 70	5,000	1 - 3 Poles
	120 / 240	50 / 60	1	0.10 - 50	5,000	2 or 3 Poles. 1 Pole of a 3 Pole Unit is Neutral
				0.10 - 50	10000 <sup>1</sup>	2 or 3 Poles. 1 Pole of a 3 Pole Unit is Neutral
	240	50 / 60	1	0.10 - 30	5,000	1Pole
240	50 / 60	1	0.10 - 20	5,000	2 Pole	
277	50 / 60	1	0.10 - 20	10,000	1Pole	
DUAL COIL	120	50 / 60	1	0.10 - 30	10,000	---

Notes from Table D:

1 Special catalog number required. Consult factory.

**Table E:** Lists UL Recognized, CSA Accepted configurations and performance capabilities as Protectors, Supplementary for Marine Electrical and Fuel Systems (Guide PEQ22, File E75596). Ignition Protected per UL 1500. UL Classified Small Craft Electrical Devices, Marine in accordance with ISO 8846 (Guide UZMK, File MQ1515) as Marine Supplementary Protectors.

C-SERIES TABLE E: UL1500 (Marine Ignition Protected)								
CIRCUIT CONFIGURATION	VOLTAGE			CURRENT RATING FULL LOAD AMPS	INTERRUPTING CAPACITY (AMPS) WITHOUT BACKUP FUSE	APPLICATION CODES		CONSTRUCTION NOTES
	MAX. RATING	FREQUENCY	PHASE			UL	CSA	
SERIES	48	DC	---	0.02 - 100	5000	TC1,2,OL1,U1	TC1,2,OL1,U1	--
				101 - 150	5000	TC1,2,OL1,U1	TC1,2,OL1,U1	--
	65	DC	---	0.02 - 100	1500	TC1,2,OL0,U1	TC1,2,OL0,U1	--
	80	DC	---	0.02 - 70	1500	TC1,2,OL1,U1	TC1,2,OL1,U1	--
	125	50 / 60	1	0.02 - 70	5000	TC1,2,OL1,U1	TC1,2,OL1,U1	--
				71 - 100	1500	TC1,2,OL1,U1	TC1,2,OL1,U1	--
	250	50 / 60	1	0.02 - 70	1500	TC1,2,OL1,U1	TC1,2,OL1,U1	--
				71 - 100	1500	TC1,2,OL1,U1	TC1,2,OL1,U1	2 Poles Breaking Single Phase

**Table F:** Lists UL Listed configurations and performance capabilities as Circuit Breakers for use in Communications Equipment (Guide DITT, File E189195), under UL489A.

C-SERIES TABLE F : PARALLEL POLE CONSTRUCTION UL489A LISTED FOR COMMUNICATIONS EQUIPMENT				
CIRCUIT CONFIGURATION	VOLTAGE		CURRENT RATING GENERAL PURPOSE AMPS	INTERRUPTING CAPACITY (AMPS) WITHOUT BACKUP FUSE
	MAX. RATING	FREQUENCY		
SERIES	80	DC	110 - 250	10,000

## Electrical

Maximum Voltage	AC, 480 WYE/277 VAC, 50/60 Hz (see Table A.) UL489: AC,240 VAC. (Table D), 50/60 Hz, 125 VDC, UL 1077, 150 VDC, 277 VAC
Current Rating	Standard current coils: 0.100, 0.250, 0.500, 0.750, 1.00, 2.50, 5.00, 7.50, 10.0, 15.0, 25.0, 30.0, 35.0, 40.0, 50.0, 60.0, 70.0, 80.0, 90.0 and 100 amps. Other ratings available, see Ordering Scheme.
Standard Voltage Coils	DC - 6V, 12V; AC - 120V; other ratings available, see Ordering Scheme.
Auxiliary Switch Rating	SPDT; 10.1 amps-250VAC, DC Aux. Switch 1.0A, 65 VDC. 0.5A, 80VDC, 1/4 HP, 125VAC, VDE & TUV 1.0 125 VAC.
Insulation Resistance Dielectric Strength	Minimum of 100 Megohms at 500 VDC. UL, CSA: 1960 V 50/60 Hz for one minute between all electrically isolated terminals. C-Series Circuit Breakers comply with the 8mm spacing and 3750V 50/60 Hz dielectric requirements from hazardous voltage to operator accessible surfaces, between adjacent poles and from main circuits to auxiliary circuits per Publications EN 60950 and VDE 0805.
Resistance, Impedance	Values from Line to Load Terminal based on Series Trip Circuit Breaker.

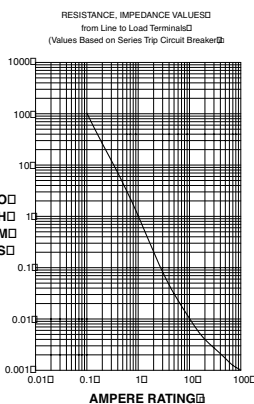

CURRENT (AMPS)	TOLERANCE (%)
0.10 - 5.0	± 15%
5.1 - 20.0	± 25%
20.1 - 100.0	± 35%

## Pulse Tolerance Curves

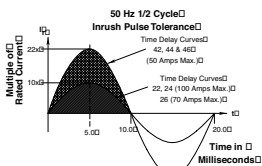
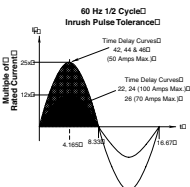

## Mechanical

Endurance	10,000 ON-OFF operations @ 6 per minute; with rated current & voltage
Trip Free	All C-Series circuit breakers will trip on overload, even when actuator is forcibly held in the ON position.
Trip Indication	The operating actuator moves positively to the OFF position when an overload causes the breaker to trip. With mid-trip, handle moves to the mid position on electrical trip of the circuit breaker. With mid trip handle with alarm switch, handle moves to the mid position and the alarm switch actuates when the circuit breaker is electrically tripped.

## Physical

Number of Poles	1-6 poles ≤ 50A; 1-4 poles @ 51-70A; 1-2 poles 71-100A. UL489 Handle: 1 pole ≤ 100A, 2 pole ≤ 50A; Rocker: 1 pole ≤ 100A.
Internal Circuit Configuration	Series (with or without auxiliary switch, mid trip & mid trip with alarm switch) Shunt & Relay with current or voltage trip coils, Dual Coil, Switch Only (with or without aux. switch). UL489: Series (with or without auxiliary switch, mid-trip & mid-trip with alarm switch).
Weight	Approx. 112 grams/pole ( 3.95 oz).
Standard Colors	Housing: Black

## Environmental

Designed and tested in accordance with requirements of specification MIL-PRF-55629 & MIL-STD-202 as follows:	
Shock	Withstands 100 Gs, 6ms sawtooth while carrying rated current per Method 213, Test Condition "I". Instantaneous and ultrashort curves tested @ 90% of rated current.
Vibration	Withstands 0.060" excursion from 10-55 Hz & 10 Gs 55-500 Hz, @ rated current per Method 204C, Test Cond. A. Instantaneous & ultrashort curves tested @ 90% of rated current.
Moisture Resistance	Method 106D, i.e., ten 24-hour cycles @ +25°C to +65°C, 80-98% RH.
Salt Spray	Method 101, Condition A (90-95% RH @ 5% NaCl Solution, 96 hrs). Method 107D, Condition A (five cycles @ -55°C to +25°C to +85°C to +25°C).
Thermal Shock	
Operating Temperature	-40°C to +85°C

**Agency Certifications:**

**UL Recognized**

UL Standard 1077      Component Recognition Program  
as Protectors, Supplementary  
(Guide CCN/QVNU2, File E75596)



UL Standard 508      Motor Controllers, Manual  
(Guide CCN/NLRV2, File E135367)



UL Standard 1500      Protectors, Supplementary for  
Marine Electrical & Fuel Systems  
(Guide PEQZ2, File E75596)  
Ignition Protection



**UL Listed**

UL Standard 489      Circuit Breakers, Molded Case,  
(Guide DIVQ, File E129899)



UL Standard 489A      Communications Equipment  
(Guide CCN/DITT, File E189195)



**CSA Accepted**      Component Supplementary Protector  
under Class 3215 30,  
File 047848 0 000  
CSA Standard C22.2 No. 235



**CSA Certified**      Circuit Breaker Model Case  
(Class 1432 01, File 093910),  
CSA Standard C22.2 No. 5.1 - M



**TUV Certified**      EN60934, under License No.  
R72041016



**VDE Certified**      EN60934, VDE 0642 under File No.  
10537



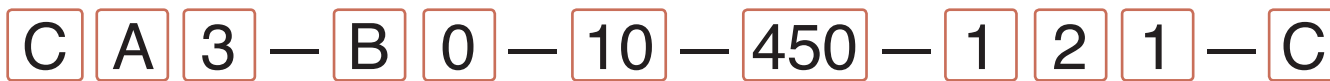

1 Series 2 Actuator 3 Poles 4 Circuit 5 Aux/Alarm Switch 6 Frequency & Delay 7 Current Rating 8 Terminal 9 Actuator Color 10 Mounting Bezel/Barrier 11 Agency Approval

**1 SERIES**

**C**

**2 ACTUATOR<sup>1</sup>**

- A** Handle, one per pole
- B** Handle, one per multipole unit
- S** Mid-Trip Handle, one per pole
- T** Mid-Trip, one per pole & Alarm Switch

**3 POLES<sup>2</sup>**

- |              |                |               |
|--------------|----------------|---------------|
| <b>1</b> One | <b>3</b> Three | <b>5</b> Five |
| <b>2</b> Two | <b>4</b> Four  | <b>6</b> Six  |

**4 CIRCUIT<sup>3</sup>**

- |  |   |
|--|---|
| <b>A<sup>3</sup></b> Switch Only (no coil) | <b>F<sup>4</sup></b> Relay Trip (current)                     |
| <b>B</b> Series Trip (current)             | <b>G<sup>4</sup></b> Relay Trip (voltage)                     |
| <b>C</b> Series Trip (voltage)             | <b>H<sup>4,5</sup></b> Dual Coil with Shunt Trip Voltage Coil |
| <b>D<sup>4</sup></b> Shunt Trip (current)  | <b>K<sup>4,5</sup></b> Dual Coil with Relay Trip Voltage Coil |
| <b>E<sup>4</sup></b> Shunt Trip (voltage)  |   |

**5 AUXILIARY/ALARM SWITCH**

- |   |   |
|---|---|
| <b>0</b> w/o Aux Switch                             | <b>5</b> S.P.S.T., 0.110 Q.C. Term. (Gold Contacts) |
| <b>2</b> S.P.D.T., 0.110 Q.C. Term.                 | <b>6</b> S.P.S.T., 0.139 Solder Lug                 |
| <b>3</b> S.P.D.T., 0.139 Solder Lug                 | <b>7</b> S.P.S.T., 0.110 Q.C. Term. (Gold Contacts) |
| <b>4</b> S.P.D.T., 0.110 Q.C. Term. (Gold Contacts) | <b>8</b> S.P.S.T., 0.187 Q.C. Term.                 |
|   | <b>9</b> S.P.D.T., 0.187 Q.C. Term.                 |

**6 FREQUENCY & DELAY**

- |   |   |
|---|---|
| <b>03<sup>3</sup></b> DC 50/60Hz, Switch Only | <b>30</b> DC 50/60Hz Instantaneous              |
| <b>10<sup>7</sup></b> DC Instantaneous        | <b>31</b> DC 50/60Hz Ultra Short                |
| <b>11</b> DC Ultra Short                      | <b>32</b> DC 50/60Hz Short                      |
| <b>12</b> DC Short                            | <b>34</b> DC 50/60Hz Medium                     |
| <b>14</b> DC Medium                           | <b>36</b> DC 50/60Hz Long                       |
| <b>16</b> DC Long                             | <b>42<sup>8</sup></b> 50/60Hz Short, Hi-Inrush  |
| <b>20<sup>7</sup></b> 50/60Hz Instantaneous   | <b>44<sup>8</sup></b> 50/60Hz Medium, Hi-Inrush |
| <b>21</b> 50/60Hz Ultra Short                 | <b>46<sup>8</sup></b> 50/60Hz Long, Hi-Inrush   |
| <b>22</b> 50/60Hz Short                       | <b>52<sup>8</sup></b> DC Short, Hi-Inrush       |
| <b>24</b> 50/60Hz Medium                      | <b>54<sup>8</sup></b> DC Medium, Hi-Inrush      |
| <b>26</b> 50/60Hz Long                        | <b>56</b> DC Long, Hi-Inrush                    |

Notes:

- 1 Actuator Code:  
A: Handle tie pin spacer(s) and retainers provided assembled with multi-pole units.  
B: Handle location as viewed from front of breaker:  
2 pole - left pole    3 pole - center pole    4 pole - two handles at center poles  
5 pole - three handles at center poles    6 pole - four handles at center poles  
S: Handle moves to mid-position only upon electrical trip of the breaker. Available with circuit codes B, C, D, E, F, G, H and K.  
T: Handle moves to mid-position and alarm switch activates only upon electrical trip of the breaker. Available with circuit codes B & C.
- 2 Standard multipole units have all poles identical except when specifying auxiliary switch and/or mixed poles. 4 pole max w/VDE. 5th pole available as Series Trip w/Voltage Coil only.
- 3 Switch Only circuits, rated up to 50 amps and 6 poles, and only available with VDE Certification when tied to a protected pole (Circuit Code B, C, D or H.). For .02 to 30 amps, select Current Code 630. For 35 - 50 amps, select Current Code 650. For 55-70 amps, select Current Code 670. For 75-100 amps, select Current Code 810.
- 4 Circuit Codes D,E,F,G,H & K available with Terminal Codes 1,2,4 & 5 only. Circuit Codes D, F, H & K available up to 50 amps maximum Current Rating.
- 5 Consult factory for available Dual Coil options, as special catalog number is required. Dual Coil Voltage Coils with Shunt Trip Construction trip instantaneously on line voltage. Dual Coil Voltage Coils require 30VA minimum power to trip instantaneously and are rated for intermittent duty only.
- 6 ers, one aux. switch is supplied, mounted in the extreme right pole. Voltage coils not rated for continuous duty. Available only with delay codes 10 and 20.
- 7 Available with Circuit Codes B & D only, and up to 50 amps maximum.
- 8 Current Ratings 60 - 70 are available up to four poles maximum. Ratings 71 - 100 are available up to two poles maximum.
- 9 Terminal Code 1 available to 60 amps maximum.
- 10 Terminal Codes 2,4,5 and C available to 50 amps maximum.
- 11 Terminal Codes 3,6 & 9 available to 100 amps maximum.
- 12 Terminal Code 7 available to 25 amps maximum.
- 13 Terminal Code A available to 100 amps maximum.
- 14 Terminal Codes 7,8,9 & C are not VDE approved.
- 15 No marking available. Consult factory. VDE/TUV Approval requires dual (I-O, ON-OFF) or I-O markings on all handles.
- 16 Single pole only.
- 17 VDE/TUV: 30 amps max.; UL/CSA: 50 amps max.; Available in 2 - 4 poles only and limited to AC Delays. "General Purpose amps" not rated for "full load amps" or to be used in applications with a motor.
- 18

**7 CURRENT RATING (AMPERES)**

CODE	AMPERES				
020	0.020	235	0.350	430	3.000
025	0.025	240	0.400	435	3.500
030	0.030	245	0.450	440	4.000
035	0.035	250	0.500	445	4.500
040	0.040	255	0.550	450	5.000
045	0.045	260	0.600	455	5.500
050	0.050	265	0.650	460	6.000
055	0.055	270	0.700	465	6.500
060	0.060	275	0.750	470	7.000
065	0.065	280	0.800	475	7.500
070	0.070	285	0.850	480	8.000
075	0.075	290	0.900	485	8.500
080	0.080	295	0.950	490	9.000
085	0.085	410	1.000	495	9.500
090	0.090	512	1.250	610	10.000
095	0.095	415	1.500	710	10.500
210	0.100	517	1.750	611	11.000
215	0.150	420	2.000	711	11.500
220	0.200	522	2.250	612	12.000
225	0.250	425	2.500	712	12.500
230	0.300	527	2.750	613	13.000

**VOLTAGE COIL (NOMINAL RATED VOLTAGE)<sup>7</sup>**

CODE	RATING				
A06	6DC	A32	32DC	J12	12AC
A12	12DC	A48	48DC	J18	18AC
A18	18DC	A65	65DC	J24	24AC
A24	24DC	J06	6AC	J48	48AC
				J65	65AC
				K20	120AC
				L40	240AC

**8 TERMINAL<sup>15</sup>**

- |  |   |
|--|---|
| <b>1<sup>10</sup></b> Stud 10-32, threaded     | <b>6<sup>12</sup></b> Screw M6, threaded            |
| <b>2<sup>11</sup></b> Screw 10-32              | <b>7<sup>13,15</sup></b> 0.250 Double Click Connect |
| <b>3<sup>12</sup></b> Screw 1/4-20, threaded   | <b>8<sup>15</sup></b> 1/4" Clip Terminal            |
| <b>4<sup>11</sup></b> Screw M5 x 0.8, threaded | <b>9<sup>12,15</sup></b> 7/16" Clip Terminal        |
| <b>5<sup>11</sup></b> Screw M5 x 0.8           | <b>A<sup>14</sup></b> Plug-In Stud                  |
|  | <b>C<sup>11,15</sup></b> 5/16" Clip Terminal        |

**9 ACTUATOR COLOR & LEGEND<sup>16</sup>**

Actuator Color	I-O	ON-OFF	Dual	Legend Color
White	<b>A</b>	<b>B</b>	<b>1</b>	Black
Black	<b>C</b>	<b>D</b>	<b>2</b>	White
Red	<b>F</b>	<b>G</b>	<b>3</b>	White
Green	<b>H</b>	<b>J</b>	<b>4</b>	White
Blue	<b>K</b>	<b>L</b>	<b>5</b>	White
Yellow	<b>M</b>	<b>N</b>	<b>6</b>	Black
Gray	<b>P</b>	<b>Q</b>	<b>7</b>	Black
Orange	<b>R</b>	<b>S</b>	<b>8</b>	Black
Black (short handle) <sup>17</sup>	<b>T</b>	<b>U</b>	<b>9</b>	White

**10 MOUNTING/BARRIERS**

	MOUNTING STYLE	BARRIERS	VOLTAGE
	<b>Threaded Insert</b>		
<b>1</b>	6-32 x 0.195 inches	no	< 300
<b>A</b>	6-32 x 0.195 inches	yes	< 300
<b>C<sup>18</sup></b>	6-32 x 0.195 inches	yes	≥ 300
<b>2</b>	ISO M3 x 5mm	no	< 300
<b>B</b>	ISO M3 x 5mm	yes	< 300
<b>D<sup>18</sup></b>	ISO M3 x 5mm	yes	≥ 300
<b>E<sup>17</sup></b>	<b>Front Panel Snap-In, 1.00" [25.4mm] wide bezel with Handeguard</b>	no	< 300

**11 AGENCY APPROVAL**

- C** UL Recognized, CSA Accepted
- D** VDE Certified, UL Recognized, CSA Accepted
- E** TUV Certified, UL Recognized, CSA Accepted
- H** UL489 Construction: VDE Certified, UL Recognized, CSA Accepted
- I** UL Rec. STD 1077, UL Rec. 1500 (ignition protected), CSA Accepted
- L** UL489 Construction: UL Recognized, CSA Accepted
- R** UL489 Construction: TUV Certified, UL Recognized, CSA Accepted

# 8 | C-Series Handle Parallel Pole UL489A Listed – Ordering Scheme

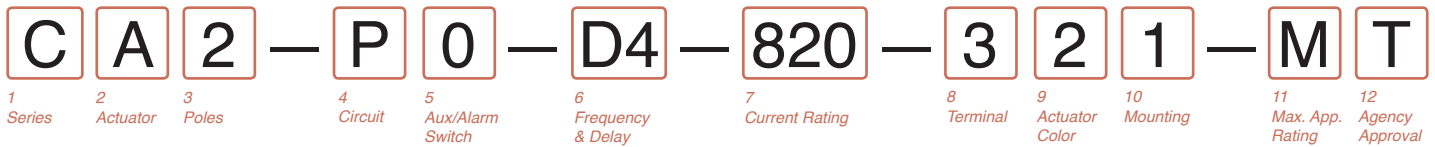

**1 SERIES**  
**C**

**2 ACTUATOR<sup>1</sup>**  
**A** Handle, one per pole  
**S** Mid-Trip Handle, one per pole  
**T** Mid-Trip, one per pole & Alarm Switch

**3 POLES<sup>3</sup>**  
**2** Two                                **3** Three

**4 CIRCUIT**  
**P** Series Trip (parallel pole)

**5 AUXILIARY/ALARM SWITCH**

<b>0</b> w/o Aux Switch	<b>5</b> S.P.S.T., 0.110 Q.C. Term. (Gold Contacts)
<b>2</b> S.P.D.T., 0.110 Q.C. Term.	<b>6</b> S.P.S.T., 0.139 Solder Lug
<b>3</b> S.P.D.T., 0.139 Solder Lug	<b>7</b> S.P.S.T., 0.110 Q.C. Term. (Gold Contacts)
<b>4</b> S.P.D.T., 0.110 Q.C. Term. (Gold Contacts)	<b>8</b> S.P.S.T., 0.187 Q.C. Term.
	<b>9</b> S.P.D.T., 0.187 Q.C. Term.

**6 FREQUENCY & DELAY**

<b>D1</b> DC Ultra Short	<b>D4</b> DC Medium
<b>D2</b> DC Short	<b>D6</b> DC Long

**7 CURRENT RATING (AMPERES)**

CODE		AMPERES	
<b>811</b>	110.000	<b>814</b>	140.000
<b>812</b>	120.000	<b>815</b>	150.000
<b>813</b>	130.000	<b>817</b>	170.000
		<b>819</b>	190.000
		<b>820</b>	200.000
		<b>922<sup>3</sup></b>	225.000
		<b>825<sup>3</sup></b>	250.000

**8 TERMINAL<sup>2</sup>**  
**3** 1/4-20, threaded  
**6** M6, threaded  
**A** Plug-In Stud

**9 ACTUATOR COLOR**

LEGEND			
ON-OFF			
		Dual	Legend Color
White	<b>B</b>	<b>1</b>	Black
Black	<b>D</b>	<b>2</b>	White
Red	<b>G</b>	<b>3</b>	White
Green	<b>J</b>	<b>4</b>	White
Blue	<b>L</b>	<b>5</b>	White
Yellow	<b>N</b>	<b>6</b>	Black
Gray	<b>Q</b>	<b>7</b>	Black
Orange	<b>S</b>	<b>8</b>	Black

**10 MOUNTING/BARRIERS**

**MOUNTING STYLE**  
**Threaded Insert**

**1** 6-32 x 0.195 inches  
**2** ISO M3 x 5mm

**11 MAXIMUM APPLICATION RATING**  
**M** 80 DC

**12 AGENCY APPROVAL**  
**T** UL489A Listed (up to 250 amps)  
**K** UL489A Listed, VDE Certified (up to 200 amps)  
**7** UL489A Listed, TUV Certified (up to 250 amps)

**Notes:**

- 1 Actuator Code:  
**A:** Handle tie pin spacer(s) and retainers provided assembled with multi-pole units.  
**S:** Handle moves to mid-position only upon electrical trip of the breaker.  
**T:** Handle moves to mid-position and alarm switch activates only upon electrical trip of the breaker.
- 2 Terminal Code:  
**3 & 6:** Supplied with bus bars connecting the Line and Load Terminals.  
**A:** Line and Load Terminals must be connected to a copper bus bar having a minimum cross section of 0.078 square inches.
- 3 Above 200 amps, 3 poles are required.





1 Series      2 Actuator      3 Poles      4 Circuit      5 Aux/Alarm Switch      6 Frequency & Delay      7 Current Rating      8 Terminal      9 Actuator Color      10 Mounting/ Barriers      11 Max. App. Rating      12 Agency Approval

**1 SERIES**  
C

**2 ACTUATOR<sup>1</sup>**  
A Handle, one per pole  
B Handle, one per multipole unit  
S Mid-Trip Handle, one per pole  
T Mid-Trip, one per pole & Alarm Switch

**3 POLES<sup>2</sup>**  
1 One                                      2 Two                                      3 Three

**4 CIRCUIT**  
B Series Trip (current)

**5 AUXILIARY/ALARM SWITCH<sup>3</sup>**

0	w/o Aux Switch	5	S.P.S.T., 0.110 Q.C. Term. (Gold Contacts)
2	S.P.D.T., 0.110 Q.C. Term.	6	S.P.S.T., 0.139 Solder Lug
3	S.P.D.T., 0.139 Solder Lug	7	S.P.S.T., 0.110 Q.C. Term. (Gold Contacts)
4	S.P.D.T., 0.110 Q.C. Term. (Gold Contacts)	8	S.P.S.T., 0.187 Q.C. Term.
		9	S.P.D.T., 0.187 Q.C. Term.

**6 FREQUENCY & DELAY**

11	DC Ultra Short	26	50/60Hz Long
12	DC Short	42 <sup>4</sup>	50/60Hz Short, Hi-Inrush
14	DC Medium	44 <sup>4</sup>	50/60Hz Medium, Hi-Inrush
16	DC Long	46 <sup>4</sup>	50/60Hz Long, Hi-Inrush
21	50/60Hz Ultra Short	52 <sup>4</sup>	DC Short, Hi-Inrush
22	50/60Hz Short	54 <sup>4</sup>	DC Medium, Hi-Inrush
24	50/60Hz Medium	56 <sup>4</sup>	DC Long, Hi-Inrush

Notes:

- 1 Actuator Code:  
A: Handle tie pin spacer(s) and retainers provided assembled with multi-pole units.  
B: Handle located, as viewed from front of breaker in left pole. 2 pole maximum.  
S: Handle moves to mid-position only upon electrical trip of the breaker.  
T: Handle moves to mid-position and alarm switch activates only upon electrical trip of the breaker.
- 2 Standard multipole units have all poles identical except when specifying auxiliary switch and/or mixed poles.  
2 & 3 pole circuit breakers required for 120/240 VAC (Maximum application rating code C) applications, have all poles identical except when specifying auxiliary / alarm switch which is normally supplied in extreme right pole per figure B. Terminal barriers are required on all multipole breakers.  
Third pole is for 120/240 VAC applications requiring neutral disconnect. The 3rd pole has the same construction as poles 1 & 2.
- 3 On multi-pole breakers, one auxiliary switch is supplied, mounted in the extreme right pole.  
VDE approval on auxiliary switch codes 2, 3 & 4 only.  
Auxiliary / Alarm Switch with Independent Circuit ie: separate from breaker circuit, only available with circuit breakers rated 50 amp maximum at 80 VDC, 125 VDC, and 120 VAC. Auxiliary / Alarm Switch with Dependent Circuit ie: same as circuit breaker, is supplied from factory with common terminal of auxiliary / alarm switch connected to line terminal on 120/240 and 240 VAC ratings. Circuit breakers rated 120 VAC 50 amp maximum can be supplied with Auxiliary/Alarm switch common terminal connected to breaker line terminal. Consult factory for special catalog number.
- 4 Available up to 50 amps maximum.
- 5 Current ratings 71 - 100 with VDE approvals are available up to two poles maximum.
- 6 Terminal Codes 8, 9 & C are not VDE approved.
- 7 Terminal Code 1 available to 60 amps maximum.
- 8 Terminal Codes 2, 4, 5 & C available to 50 amps maximum.
- 9 Terminal Codes 3, 6 & 9 available to 100 amps maximum.
- 10 Terminal Code A available to 100 amps maximum.
- 11 VDE and TUV approvals require Dual (I-O, ON-OFF) markings on all handles.
- 12 Barriers supplied on multi-pole units only.

**7 CURRENT RATING (AMPERES)<sup>5</sup>**

CODE	AMPERES				
210	0.100	295	0.950	470	7.000
215	0.150	410	1.000	475	7.500
220	0.200	512	1.250	480	8.000
225	0.250	415	1.500	485	8.500
230	0.300	517	1.750	490	9.000
235	0.350	420	2.000	495	9.500
240	0.400	522	2.250	610	10.000
245	0.450	425	2.500	710	10.500
250	0.500	527	2.750	611	11.000
255	0.550	430	3.000	711	11.500
260	0.600	435	3.500	612	12.000
265	0.650	440	4.000	712	12.500
270	0.700	445	4.500	613	13.000
275	0.750	450	5.000	614	14.000
280	0.800	455	5.500	615	15.000
285	0.850	460	6.000	616	16.000
290	0.900	465	6.500	617	17.000
				618	18.000
				620	20.000
				622	22.000
				624	24.000
				625	25.000
				630	30.000
				635	35.000
				640	40.000
				660	60.000
				670	70.000
				680	80.000
				685	85.000
				690	90.000
				695	95.000
				810	100.000

**8 TERMINAL<sup>6</sup>**

1 <sup>7</sup>	Stud 10-32, threaded	6 <sup>9</sup>	Screw M6, threaded
2 <sup>8</sup>	Screw 10-32	8	1/4" Clip Terminal
3 <sup>9</sup>	Screw 1/4-20, threaded	9 <sup>9</sup>	7/16" Clip Terminal
4 <sup>8</sup>	Screw M5 x 0.8, threaded	A <sup>10</sup>	Plug-In Stud
5 <sup>8</sup>	Screw M5 x 0.8	C	5/16" Clip Terminal

**9 ACTUATOR COLOR & LEGEND<sup>11</sup>**

Actuator Color	ON-OFF	Dual	Legend Color
White	B	1	Black
Black	D	2	White
Red	G	3	White
Green	J	4	White
Blue	L	5	White
Yellow	N	6	Black
Gray	Q	7	Black
Orange	S	8	Black

**10 MOUNTING/BARRIERS**

	MOUNTING STYLE <i>Threaded Insert</i>	BARRIERS <sup>12</sup>
1	6-32 x 0.195 inches	yes
2	ISO M3 x 5mm	yes

**11 MAXIMUM APPLICATION RATING**

A	65 DC
B	125 DC
C	120/240 AC <sup>2</sup>
D	240 AC
K	120 AC
M	80 DC

**12 AGENCY APPROVAL<sup>11</sup>**

A	w/o approvals
F	UL489 Listed, VDE Certified, CSA Accepted
G	UL489 Listed, CSA Accepted
J	UL489 Listed, TUV Certified, CSA Accepted

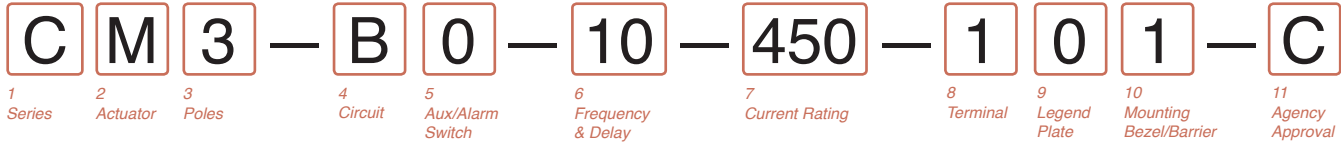

**1 SERIES**  
**C**

**2 ACTUATOR<sup>1</sup>**  
**M** Sealed Toggle, one per pole

**3 POLES**

**1** One                              **2** Two                              **3** Three

**4 CIRCUIT**

<b>A</b> <sup>2</sup>	Switch Only (no coil)	<b>F</b> <sup>3</sup>	Relay Trip (current)
<b>B</b>	Series Trip (current)	<b>G</b> <sup>3</sup>	Relay Trip (voltage)
<b>C</b>	Series Trip (voltage)	<b>H</b> <sup>3,4</sup>	Dual Coil with Shunt Trip Voltage Coil
<b>D</b> <sup>3</sup>	Shunt Trip (current)	<b>K</b> <sup>3,4</sup>	Dual Coil with Relay Trip Voltage Coil
<b>E</b> <sup>3</sup>	Shunt Trip (voltage)		

**5 AUXILIARY/ALARM SWITCH**

<b>0</b>	w/o Aux Switch	<b>5</b>	S.P.S.T., 0.110 Q.C. Term. (Gold Contacts)
<b>2</b>	S.P.D.T., 0.110 Q.C. Term.	<b>6</b>	S.P.S.T., 0.139 Solder Lug
<b>3</b>	S.P.D.T., 0.139 Solder Lug	<b>7</b>	S.P.S.T., 0.110 Q.C. Term. (Gold Contacts)
<b>4</b>	S.P.D.T., 0.110 Q.C. Term. (Gold Contacts)	<b>8</b>	S.P.S.T., 0.187 Q.C. Term.
		<b>9</b>	S.P.D.T., 0.187 Q.C. Term.

**6 FREQUENCY & DELAY**

<b>03</b> <sup>2</sup>	DC 50/60Hz, Switch Only	<b>30</b>	DC 50/60Hz Instantaneous
<b>10</b> <sup>6</sup>	DC Instantaneous	<b>31</b>	DC 50/60Hz Ultra Short
<b>11</b>	DC Ultra Short	<b>32</b>	DC 50/60Hz Short
<b>12</b>	DC Short	<b>34</b>	DC 50/60Hz Medium
<b>14</b>	DC Medium	<b>36</b>	DC 50/60Hz Long
<b>16</b>	DC Long	<b>42</b> <sup>7</sup>	50/60Hz Short, Hi-Inrush
<b>20</b> <sup>6</sup>	50/60Hz Instantaneous	<b>44</b> <sup>7</sup>	50/60Hz Medium, Hi-Inrush
<b>21</b>	50/60Hz Ultra Short	<b>46</b> <sup>7</sup>	50/60Hz Long, Hi-Inrush
<b>22</b>	50/60Hz Short	<b>52</b> <sup>7</sup>	DC Short, Hi-Inrush
<b>24</b>	50/60Hz Medium	<b>54</b> <sup>7</sup>	DC Medium, Hi-Inrush
<b>26</b>	50/60Hz Long	<b>56</b>	DC Long, Hi-Inrush

- Notes:
- 1 Actuator Code M: Handle location as viewed from front of breaker: 2 pole - right pole    3 pole - center pole
  - 2 Switch Only circuits, rated up to 50 amps and 3 poles, and only available with VDE. For .02 to 30 amps, select Current Code 630. For 35 - 50 amps, select Current Code 650. For 55-70 amps, select Current Code 670. For 75-100 amps, select Current Code 810.
  - 3 Circuit Codes D,E,F,G,H & K available with Terminal Codes 1,2,4 & 5 only.
  - 4 Consult factory for available Dual Coil options, as special catalog number is required. Dual Coil Voltage Coils with Shunt Trip Construction trip instantaneously on line voltage. Dual Coil Voltage Coils require 30VA minimum power to trip instantaneously and are rated for intermittent duty only.
  - 5 Auxiliary Switch available with Series Trip and Switch Only circuits. On multi-pole breakers, one aux. switch is supplied, mounted in the extreme right pole.
  - 6 Voltage coils not rated for continuous duty. Available only with delay codes 10 and 20.
  - 7 Available with Circuit Codes B & D only, and up to 50 amps maximum.
  - 8 Consult factory for current ratings 71-100, in three pole units, available as special catalog number only.
  - 9 Terminal Code 1 available to 60 amps maximum.
  - 10 Terminal Codes 2,4,5 and C available to 50 amps maximum.
  - 11 Terminal Codes 3,6 & 9 available to 100 amps maximum.
  - 12 Terminal Code 7 available to 25 amps maximum.
  - 13 Terminal Code A available to 100 amps maximum.

**7 CURRENT RATING (AMPERES)<sup>9</sup>**

CODE	AMPERES						
020	0.020	235	0.350	430	3.000	614	14.000
025	0.025	240	0.400	435	3.500	615	15.000
030	0.030	245	0.450	440	4.000	616	16.000
035	0.035	250	0.500	445	4.500	617	17.000
040	0.040	255	0.550	450	5.000	618	18.000
045	0.045	260	0.600	455	5.500	620	20.000
050	0.050	265	0.650	460	6.000	622	22.000
055	0.055	270	0.700	465	6.500	624	24.000
060	0.060	275	0.750	470	7.000	625	25.000
065	0.065	280	0.800	475	7.500	630	30.000
070	0.070	285	0.850	480	8.000	635	35.000
075	0.075	290	0.900	485	8.500	640	40.000
080	0.080	295	0.950	490	9.000	650	50.000
085	0.085	410	1.000	495	9.500	660 <sup>9</sup>	60.000
090	0.090	512	1.250	610	10.000	670 <sup>9</sup>	70.000
095	0.095	415	1.500	710	10.500	680 <sup>9</sup>	80.000
210	0.100	517	1.750	611	11.000	685 <sup>9</sup>	85.000
215	0.150	420	2.000	711	11.500	690 <sup>9</sup>	90.000
220	0.200	522	2.250	612	12.000	695 <sup>9</sup>	95.000
225	0.250	425	2.500	712	12.500	810 <sup>9</sup>	100.000
230	0.300	527	2.750	613	13.000		

**VOLTAGE COIL (NOMINAL RATED VOLTAGE)<sup>7</sup>**

CODE	RATING						
A06	6DC	A32	32DC	J12	12AC	J65	65AC
A12	12DC	A48	48DC	J18	18AC	K20	120AC
A18	18DC	A65	65DC	J24	24AC	L40	240AC
A24	24DC	J06	6AC	J48	48AC		

**8 TERMINAL**

<b>1</b> <sup>9</sup>	Stud 10-32, threaded	<b>6</b> <sup>11</sup>	Screw M6, threaded
<b>2</b> <sup>10</sup>	Screw 10-32	<b>7</b> <sup>12</sup>	0.250 Double Click Connect
<b>3</b> <sup>11</sup>	Screw 1/4-20, threaded	<b>8</b>	1/4" Clip Terminal
<b>4</b> <sup>10</sup>	Screw M5 x 0.8, threaded	<b>9</b> <sup>11</sup>	7/16" Clip Terminal
<b>5</b> <sup>10</sup>	Screw M5 x 0.8	<b>A</b> <sup>13</sup>	Plug-In Stud
		<b>C</b> <sup>10</sup>	5/16" Clip Terminal

**9 LEGEND PLATE**

**0** No Legend

**10 MOUNTING/BARRIERS**

	<b>MOUNTING STYLE</b>	<b>BARRIERS</b>
<b>1</b>	Standard Hex Nut	no
<b>A</b>	Standard Hex Nut (multi-pole units only)	yes

**11 AGENCY APPROVAL**

<b>C</b>	UL Recognized, CSA Accepted
<b>L</b>	UL Recognized, CSA Accepted with listed construction
<b>I</b>	UL Recognized, CSA Accepted, UL1500 ignition protection

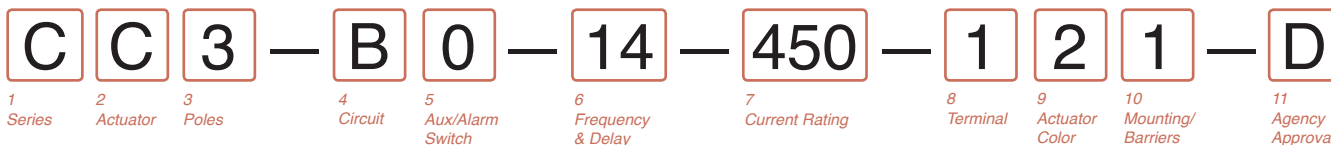

**1 SERIES**

**C**

**2 ACTUATOR<sup>1</sup>**

**Two Color Visi-Rocker**

- C** Indicate ON, vertical legend
- D** Indicate ON, horizontal legend
- E** Indicate ON, no legend
- F** Indicate OFF, vertical legend
- G** Indicate OFF, horizontal legend
- H** Indicate OFF, no legend

**Single color**

- J** Vertical legend
- K** Horizontal legend
- L** No legend

**Push-To-Reset, Single color**

- R** Vertical legend
- U** Horizontal legend
- V** No legend

**Push-To-Reset, Visi-Rocker**

- N** Indicate OFF, vertical legend
- O** Indicate OFF, horizontal legend
- P** Indicate OFF, no legend

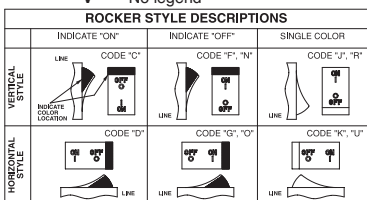

**3 POLES<sup>2</sup>**

- 1** One
- 2** Two
- 3** Three

**4 CIRCUIT**

- A<sup>3</sup>** Switch Only (No Coil)
- B** Series Trip (Current)
- C** Series Trip (Voltage)
- D<sup>4</sup>** Shunt Trip (Current)
- E<sup>4</sup>** Shunt Trip (Voltage)

- F<sup>4</sup>** Relay Trip (Current)
- G<sup>4</sup>** Relay Trip (Voltage)
- H<sup>4,5</sup>** Dual Coil with Shunt Trip Voltage Coil
- K<sup>4,5</sup>** Dual Coil with Relay Trip Voltage Coil

**5 AUXILIARY/ALARM SWITCH<sup>5</sup>**

- 0** w/o Aux Switch
- 2** S.P.D.T., 0.110 Q.C. Term.
- 3** S.P.D.T., 0.139 Solder Lug
- 4** S.P.D.T., 0.110 Q.C. Term. (Gold Contacts)

- 5** S.P.S.T., 0.110 Q.C. Term. (Gold Contacts)
- 6** S.P.S.T., 0.139 Solder Lug
- 7** S.P.S.T., 0.110 Q.C. Term. (Gold Contacts)
- 8** S.P.S.T., 0.187 Q.C. Term.
- 9** S.P.D.T., 0.187 Q.C. Term.

**6 FREQUENCY & DELAY**

- 03** DC 50/60Hz, Switch Only
- 10<sup>7</sup>** DC Instantaneous
- 11** DC Ultra Short
- 12** DC Short
- 14** DC Medium
- 16** DC Long
- 20<sup>7</sup>** 50/60Hz Instantaneous
- 21** 50/60Hz Ultra Short
- 22** 50/60Hz Short
- 24** 50/60Hz Medium
- 26** 50/60Hz Long

- 30** DC 50/60Hz Instantaneous
- 31** DC 50/60Hz Ultra Short
- 32** DC 50/60Hz Short
- 34** DC 50/60Hz Medium
- 36** DC 50/60Hz Long
- 42<sup>8</sup>** 50/60Hz Short, Hi-Inrush
- 44<sup>8</sup>** 50/60Hz Medium, Hi-Inrush
- 46<sup>8</sup>** 50/60Hz Long, Hi-Inrush
- 52<sup>8</sup>** DC Short, Hi-Inrush
- 54<sup>8</sup>** DC Medium, Hi-Inrush
- 56<sup>8</sup>** DC Long, Hi-Inrush

Notes:

- 1 Push-To-Reset actuators have OFF portion of rocker shrouded.
- 2 Multi-pole breakers have all poles identical except when specifying Aux. switch and/or mixed poles, and have one rocker per breaker. Rocker location as viewed from front panel: 2 pole – left pole; 3 pole – center pole.
- 3 Switch Only circuits, rated up to 50 amps and 3 poles, and only available with VDE Certification when tied to a protected pole (Circuit Code B, C, D or H). For .02 to 30 amps, select Current Code 630. For 35 - 50 amps, select Current Code 650. For 55-70 amps, select Current Code 670. For 75-100 amps, select Current Code 810.
- 4 Circuit Codes D, E, F, G, H & K available with Terminal Codes 1, 2, 4 & 5 only. Circuit Codes D, F, H & K available up to 50 amps maximum Current Rating.
- 5 Consult factory for available Dual Coil options, as special catalog number is required. Dual Coil Voltage Coils with Shunt Trip Construction trip instantaneously on line voltage. Dual Coil Voltage Coils require 30VA minimum power to trip instantaneously and are rated for intermittent duty only. Auxiliary Switch available with Series Trip and Switch Only circuits. On multi-pole breakers, one aux. switch is supplied, mounted in the extreme right pole. Auxiliary switch codes 2, 3 & 4 are VDE approved.
- 6 Voltage coils not rated for continuous duty. Available only with delay codes 10 and 20.
- 7 Available with Circuit Codes B & D only, and up to 50 amps maximum.
- 8 Current Ratings 60-70 are available up to four poles maximum. Ratings 71-100 are available up to two poles maximum.
- 9 Terminal Code 1 available to 60 amps maximum.
- 10 Terminal Codes 2, 4, 5 & C available to 50 amps maximum.
- 11 Terminal Codes 3, 6 & 9 available to 100 amps maximum.
- 12 Terminal Code 7 available to 25 amps maximum.
- 13 Terminal Code A available to 100 amps maximum.
- 14 Terminal Codes 7, 8, 9 & C are not VDE approved.
- 15 Color shown is visi and legend with remainder of rocker black
- 16 Legend on Push-to-reset bezel/shroud is white when single color rocker is ordered. Dual = ON-OFF/I-O legend with actuator codes C - G, and J, K, N, O, R, & U. None = no legend with actuator codes H, L, P, V. Rocker-guard available with actuator codes C - L. Push-to-reset available with actuator codes N, O, P, R, U, V.
- 17 VDE/TUV approval requires Dual (I-O, ON-OFF) or I-O markings on rocker.
- 18 VDE/TUV: 30 amps max.; UL/CSA: 50 amps max.; Available in 2 - 4 poles only and limited to AC Delays.
- 19 "General Purpose amps" not rated for "full load amps" or to be used in applications with a motor.

**7 CURRENT RATING (AMPERES)**

CODE	AMPERES				
020	0.020	235	0.350	430	3.000
025	0.025	240	0.400	435	3.500
030	0.030	245	0.450	440	4.000
035	0.035	250	0.500	445	4.500
040	0.040	255	0.550	450	5.000
045	0.045	260	0.600	455	5.500
050	0.050	265	0.650	460	6.000
055	0.055	270	0.700	465	6.500
060	0.060	275	0.750	470	7.000
065	0.065	280	0.800	475	7.500
070	0.070	285	0.850	480	8.000
075	0.075	290	0.900	485	8.500
080	0.080	295	0.950	490	9.000
085	0.085	410	1.000	495	9.500
090	0.090	512	1.250	610	10.000
095	0.095	415	1.500	710	10.500
210	0.100	517	1.750	611	11.000
215	0.150	420	2.000	711	11.500
220	0.200	522	2.250	612	12.000
225	0.250	425	2.500	712	12.500
230	0.300	527	2.750	613	13.000

**VOLTAGE COIL (NOMINAL RATED VOLTAGE<sup>9</sup>)**

CODE	RATING				
A06	6DC	A32	32DC	J12	12AC
A12	12DC	A48	48DC	J18	18AC
A18	18DC	A65	65DC	J24	24AC
A24	24DC	J06	6AC	J48	48AC
				J65	65AC
				K20	120AC
				L40	240AC

**8 TERMINAL**

- 1<sup>10</sup>** Stud 10-32, threaded
- 2<sup>11</sup>** Screw 10-32
- 3<sup>12</sup>** Stud 1/4-20, threaded
- 4<sup>11</sup>** Stud M5 x 0.8, threaded
- 5<sup>11</sup>** Screw M5 x 0.8
- 6<sup>12</sup>** Stud M6, threaded
- 7<sup>13</sup>** 0.250 Double Quick Connect
- 8** 1/4" Clip Terminal
- 9** 7/16" Clip Terminal
- A<sup>14</sup>** Plug-In Stud
- C** 5/16" Clip Terminal

**9 ACTUATOR COLOR & LEGEND<sup>16,17,18</sup>**

Actuator or Visi-Color	Marking:	Marking Color:	Single Color Rocker/Handle	Visi-Rocker
Color:	I-O	ON-OFF	Dual/None	
White	A	B	1	Black
Black	C	D	2	White
Red	F	G	3	White
Green	H	J	4	White
Blue	K	L	5	White
Yellow	M	N	6	Black
Gray	P	Q	7	Black
Orange	R	S	8	Black

**10 MOUNTING/BARRIERS<sup>1</sup>**

	Standard Rocker Bezel	BARRIERS
<b>1</b>	6-32 x 0.195 inches	no
<b>2</b>	6-32 x 0.195 inches	yes
<b>3<sup>19</sup></b>	6-32 x 0.195 inches	yes
<b>4</b>	ISO M3 x 5mm	no
<b>5</b>	ISO M3 x 5mm	yes
<b>6<sup>19</sup></b>	ISO M3 x 5mm	yes
	<b>Rockerguard Bezel</b>	
<b>A</b>	6-32 x 0.195 inches	no
<b>B</b>	6-32 x 0.195 inches	yes
<b>C</b>	6-32 x 0.195 inches	yes
<b>E<sup>19</sup></b>	6-32 x 0.195 inches	yes
<b>G</b>	ISO M3 x 5mm	no
<b>J</b>	ISO M3 x 5mm	yes
<b>L<sup>19</sup></b>	ISO M3 x 5mm	yes
	<b>Push-To-Reset Bezel</b>	
<b>D</b>	6-32 x 0.195 inches	no
<b>F<sup>19</sup></b>	6-32 x 0.195 inches	yes
<b>H</b>	ISO M3 x 5mm	no
<b>I</b>	ISO M3 x 5mm	yes
<b>M<sup>19</sup></b>	ISO M3 x 5mm	yes

**11 AGENCY APPROVAL**

- C** UL Recognized, CSA Accepted
- D** VDE Certified, UL Recognized, CSA Accepted
- E** TUV Certified, UL Recognized, CSA Accepted
- H** UL489 Construction: VDE Certified, UL Recognized, CSA Accepted
- I** UL Rec. STD 1077, UL Rec. 1500 (ignition protected), CSA Accepted
- L** UL489 Construction: UL Recognized, CSA Accepted
- R** UL489 Construction: TUV Certified, UL Recognized, CSA Accepted

**C C 3 – B 0 – 14 – 450 – 1 2 A – K G**

1 Series    2 Actuator    3 Poles    4 Circuit    5 Aux/Alarm Switch    6 Frequency & Delay    7 Current Rating    8 Terminal    9 Actuator Color    10 Mounting/Barriers    11 Max. App. Rating    12 Agency Approval

**1 SERIES**  
**C**

**2 ACTUATOR<sup>1</sup>**

**Two Color Visi-Rocker**

- C** Indicate ON, vertical legend
- D** Indicate ON, horizontal legend
- F** Indicate OFF, vertical legend
- G** Indicate OFF, horizontal legend

- Single color**
- J** Vertical legend
  - K** Horizontal legend

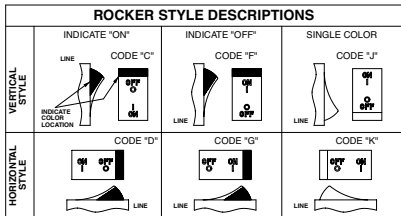

**3 POLES<sup>1</sup>**

- 1** One
- 2** Two
- 3** Three

**4 CIRCUIT**

- B** Series Trip (current)

**5 AUXILIARY/ALARM SWITCH<sup>2</sup>**

- 0** w/o Aux Switch
- 2** S.P.D.T., 0.110 Q.C. Term.
- 3** S.P.D.T., 0.139 Solder Lug
- 4** S.P.D.T., 0.110 Q.C. Term. (Gold Contacts)
- 5** S.P.S.T., 0.110 Q.C. Term. (Gold Contacts)
- 6** S.P.S.T., 0.139 Solder Lug
- 7** S.P.S.T., 0.110 Q.C. Term. (Gold Contacts)
- 8** S.P.S.T., 0.187 Q.C. Term.
- 9** S.P.D.T., 0.187 Q.C. Term.

**6 FREQUENCY & DELAY**

- 11** DC Ultra Short
- 12** DC Short
- 14** DC Medium
- 16** DC Long
- 21** 50/60Hz Ultra Short
- 22** 50/60Hz Short
- 24** 50/60Hz Medium
- 26** 50/60Hz Long
- 42<sup>B</sup>** 50/60Hz Short, Hi-Inrush
- 44<sup>B</sup>** 50/60Hz Medium, Hi-Inrush
- 46<sup>B</sup>** 50/60Hz Long, Hi-Inrush
- 52<sup>B</sup>** DC Short, Hi-Inrush
- 54<sup>B</sup>** DC Medium, Hi-Inrush
- 56** DC Long, Hi-Inrush

- Notes:
- 1 Multi-pole breakers have all breakers identical except when specifying Aux. switch and/or mixed poles, and have one rocker per breaker.
  - 2 On multi-pole breakers, one aux. switch is supplied, mounted in the extreme right pole.
  - 3 Available up to 50 amps maximum.
  - 4 Current ratings 71 - 100 with VDE approvals are available up to two poles maximum.
  - 5 Terminal Code 1 available to 60 amps maximum.
  - 6 Terminal Codes 2, 4, 5 & C available to 50 amps maximum.
  - 7 Terminal Codes 3, 6, 9 & A available to 100 amps maximum.
  - 8 Terminal Codes 8, 9 & C are not VDE approved.
  - 9 Color shown is visi and legend with remainder of rocker black
  - 10 Dual = ON-OFF/I-O legend on actuator.
  - 11 VDE and TUV approval requires Dual (I-O, ON-OFF) markings on rocker.
  - 12 Rockerguard available with all actuator codes.
  - 13 Barriers supplied on multi-pole units only.
  - 14 2 & 3 pole circuit breakers required for 120/240 AC rating.

**7 CURRENT RATING (AMPERES)<sup>4</sup>**

CODE	AMPERES						
210	0.100	295	0.950	470	7.000	618	18.000
215	0.150	410	1.000	475	7.500	620	20.000
220	0.200	512	1.250	480	8.000	622	22.000
225	0.250	415	1.500	485	8.500	624	24.000
230	0.300	517	1.750	490	9.000	625	25.000
235	0.350	420	2.000	495	9.500	630	30.000
240	0.400	522	2.250	610	10.000	635	35.000
245	0.450	425	2.500	710	10.500	640	40.000
250	0.500	527	2.750	611	11.000	650	50.000
255	0.550	430	3.000	711	11.500	660	60.000
260	0.600	435	3.500	612	12.000	670	70.000
265	0.650	440	4.000	712	12.500	680	80.000
270	0.700	445	4.500	613	13.000	685	85.000
275	0.750	450	5.000	614	14.000	690	90.000
280	0.800	455	5.500	615	15.000	695	95.000
285	0.850	460	6.000	616	16.000	100	100.000
290	0.900	465	6.500	617	17.000		

**8 TERMINAL**

- 1<sup>5</sup> Stud 10-32, threaded
- 2<sup>6</sup> Screw 8-32 w/saddle & washer clamps
- 3<sup>7</sup> Stud 1/4-20, threaded
- 4<sup>6</sup> Stud M5 x 0.8, threaded
- 5<sup>6</sup> Screw M5 x 0.8 w/saddle & washer clamps
- 6<sup>7</sup> Stud M6, threaded
- 8<sup>8</sup> 1/4" Clip Terminal
- 9<sup>7,8</sup> 7/16" Clip Terminal
- A<sup>7,8</sup> Plug-In Stud
- C<sup>8,9</sup> 5/16" Clip Terminal

**9 ACTUATOR COLOR & LEGEND<sup>11</sup>**

Actuator or Visi-Color <sup>9</sup>	Marking:	Marking Color:		
<b>Color:</b>	<b>ON-OFF</b>	<b>Dual<sup>10</sup></b>	<b>Single Color Rocker/Handle</b>	<b>Visi-Rocker</b>
White	<b>B</b>	<b>1</b>	Black	White
Black	<b>D</b>	<b>2</b>	White	n/a
Red	<b>G</b>	<b>3</b>	White	Red
Green	<b>J</b>	<b>4</b>	White	Green
Blue	<b>L</b>	<b>5</b>	White	Blue
Yellow	<b>N</b>	<b>6</b>	Black	Yellow
Gray	<b>Q</b>	<b>7</b>	Black	Gray
Orange	<b>S</b>	<b>8</b>	Black	Orange

**10 MOUNTING/BARRIERS<sup>12</sup>**

	Standard Rocker Bezel Threaded Insert, 2 per pole	BARRIERS <sup>13</sup>
<b>A</b>	6-32 x 0.195 inches	yes
<b>C</b>	ISO M3 x 5mm	yes
	<b>Rockerguard Bezel Threaded Insert, 2 per pole</b>	
<b>B</b>	6-32 x 0.195 inches	yes
<b>D</b>	ISO M3 x 5mm	yes

**11 MAXIMUM APPLICATION RATING**

- A** 65 DC
- B** 125 DC
- C** 120/240 AC<sup>14</sup>
- D** 240 AC
- K** 120 AC
- M** 80 DC

**12 AGENCY APPROVAL**

- A** without approvals
- F** UL 489 Listed, CSA Certified, & VDE Certified
- G** UL 489 Listed & CSA Certified
- J** UL489 Listed, CSA Certified & TUV Certified

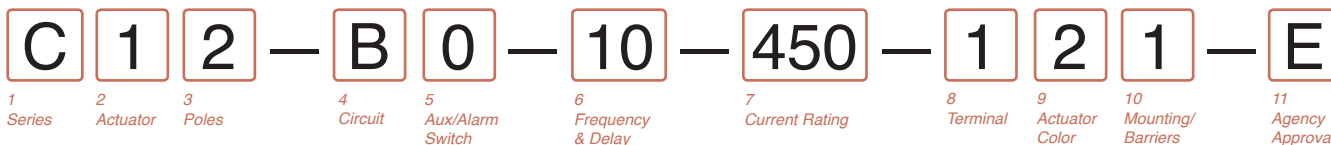

**1 SERIES**  
**C**

**2 ACTUATOR<sup>1</sup>**

**Two Color Visi-Rocker**

- 1 Indicate OFF, vertical legend
- 2 Indicate OFF, horizontal legend

**Single color**

- 3 Vertical legend
- 4 Horizontal legend
- Push-To-Reset, Visi-Rocker**
- 5 Indicate OFF, vertical legend
- 6 Indicate OFF, horizontal legend
- Push-To-Reset, Single color**
- 7 Vertical legend
- 8 Horizontal legend

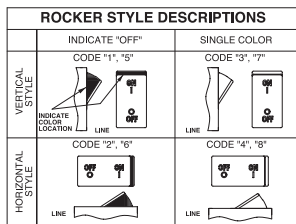

**3 POLES<sup>2</sup>**

- 1 One
- 2 Two
- 3 Three

**4 CIRCUIT**

- A<sup>3</sup> Switch Only (No Coil)
- B Series Trip (Current)
- C Series Trip (Voltage)
- D<sup>4</sup> Shunt Trip (Current)
- E<sup>4</sup> Shunt Trip (Voltage)
- F<sup>4</sup> Relay Trip (Current)
- G<sup>4</sup> Relay Trip (Voltage)
- H<sup>4,5</sup> Dual Coil with Shunt Trip Voltage Coil
- K<sup>4,5</sup> Dual Coil with Relay Trip Voltage Coil

**5 AUXILIARY/ALARM SWITCH<sup>6</sup>**

- 0 w/o Aux Switch
- 2 S.P.D.T., 0.110 Q.C. Term.
- 3 S.P.D.T., 0.139 Solder Lug
- 4 S.P.D.T., 0.110 Q.C. Term. (Gold Contacts)
- 5 S.P.S.T., 0.110 Q.C. Term. (Gold Contacts)
- 6 S.P.S.T., 0.139 Solder Lug
- 7 S.P.S.T., 0.110 Q.C. Term. (Gold Contacts)
- 8 S.P.S.T., 0.187 Q.C. Term.
- 9 S.P.D.T., 0.187 Q.C. Term.

**6 FREQUENCY & DELAY**

- 03 DC 50/60Hz, Switch Only
- 10<sup>7</sup> DC Instantaneous
- 11 DC Ultra Short
- 12 DC Short
- 14 DC Medium
- 16 DC Long
- 20<sup>7</sup> 50/60Hz Instantaneous
- 21 50/60Hz Ultra Short
- 22 50/60Hz Short
- 24 50/60Hz Medium
- 26 50/60Hz Long
- 30 DC 50/60Hz Instantaneous
- 31 DC 50/60Hz Ultra Short
- 32 DC 50/60Hz Short
- 34 DC 50/60Hz Medium
- 36 DC 50/60Hz Long
- 42<sup>8</sup> 50/60Hz Short, Hi-Inrush
- 44<sup>8</sup> 50/60Hz Medium, Hi-Inrush
- 46<sup>8</sup> 50/60Hz Long, Hi-Inrush
- 52<sup>8</sup> DC Short, Hi-Inrush
- 54<sup>8</sup> DC Medium, Hi-Inrush
- 56<sup>8</sup> DC Long, Hi-Inrush

Notes:

- 1 Push-to-reset actuators have OFF portion of rocker shrouded.
- 2 Multi-pole breakers have all poles identical except when specifying Aux. switch and/or mixed poles, and have one rocker per breaker. Rocker location as viewed from front panel: 2 pole – left pole, 3 pole – center pole.
- 3 Switch Only circuits, rated up to 50 amps and 3 poles, and only available with VDE Certification when tied to a protected pole (Circuit Code B, C, D or H). For .02 to 30 amps, select Current Code 630. For 35 - 50 amps, select Current Code 650. For 55-70 amps, select Current Code 670. For 75-100 amps, select Current Code 810. Circuit Codes D,E,F,G,H & K available with Terminal Codes 1,2,4 & 5 only. Circuit Codes D,F,H & K available up to 50 amps maximum Current Rating.
- 5 Consult factory for available Dual Coil options, as special catalog number is required. Dual Coil Voltage Coils with Shunt Trip Construction trip instantaneously on line voltage. Dual Coil Voltage Coils require 30VA minimum power to trip instantaneously and are rated for intermittent duty only.
- 6 Auxiliary Switch available with Series Trip and Switch Only circuits. On multi-pole breakers, one aux. switch is supplied, mounted in the extreme right pole. Auxiliary switch codes 2,3 & 4 are VDE approved.
- 7 Voltage coils not rated for continuous duty. Available only with delay codes 10 and 20.
- 8 Available with Circuit Codes B & D only, and up to 50 amps maximum.
- 9 Current ratings 60-70 are available up to four poles maximum. Current ratings 71 - 100 are available up to two poles maximum.
- 10 Terminal Code 1 available to 60 amps maximum.
- 11 Terminal Codes 2,4,5 & C available to 50 amps maximum.
- 12 Terminal Codes 3,6 & 9 available to 100 amps maximum.
- 13 Terminal Code 7 available to 25 amps maximum.
- 14 Terminal Code A available to 100 amps maximum.
- 15 Terminal Codes 7,8,9 & C are not VDE approved.
- 16 Color shown is visi & legend with remainder of rocker black. Dual = ON-OFF/I-O legend.
- 17 Legend on Push-to-reset bezel/shroud is white with single color actuator codes 7 & 8. Legend on Push-to-reset bezel/shroud matches visi-color of rocker with actuator codes 5 & 6.
- 18 VDE/TUV approval requires Dual (I-O, ON-OFF) or I-O markings on rocker.
- 19 VDE/TUV: 30 amps max.; UL/CSA: 50 amps max.; Available in 2 & 3 poles only and limited to AC Delays. "General Purpose amps" not rated for "full load amps" or to be used in applications with a motor.
- 20 Recessed "OFF SIDE" available with actuator codes 1,2,3&4. Legends on rocker are available in ink stamping only.

**7 CURRENT RATING (AMPERES)<sup>9</sup>**

CODE	AMPERES				
020	0.020	235	0.350	430	3.000
025	0.025	240	0.400	435	3.500
030	0.030	245	0.450	440	4.000
035	0.035	250	0.500	445	4.500
040	0.040	255	0.550	450	5.000
045	0.045	260	0.600	455	5.500
050	0.050	265	0.650	460	6.000
055	0.055	270	0.700	465	6.500
060	0.060	275	0.750	470	7.000
065	0.065	280	0.800	475	7.500
070	0.070	285	0.850	480	8.000
075	0.075	290	0.900	485	8.500
080	0.080	295	0.950	490	9.000
085	0.085	410	1.000	495	9.500
090	0.090	512	1.250	610	10.000
095	0.095	415	1.500	710	10.500
210	0.100	517	1.750	611	11.000
215	0.150	420	2.000	711	11.500
220	0.200	522	2.250	612	12.000
225	0.250	425	2.500	712	12.500
230	0.300	527	2.750	613	13.000
				614	14.000
				615	15.000
				616	16.000
				617	17.000
				618	18.000
				620	20.000
				622	22.000
				624	24.000
				625	25.000
				630	30.000
				635	35.000
				640	40.000
				650	50.000
				660 <sup>9</sup>	60.000
				670 <sup>9</sup>	70.000
				680 <sup>9</sup>	80.000
				685 <sup>9</sup>	85.000
				690 <sup>9</sup>	90.000
				695 <sup>9</sup>	95.000
				810 <sup>9</sup>	100.000

**VOLTAGE COIL (NOMINAL RATED VOLTAGE)<sup>7</sup>**

CODE	RATING				
A06	6DC	A32	32DC	J12	12AC
A12	12DC	A48	48DC	J18	18AC
A18	18DC	A65	65DC	J24	24AC
A24	24DC	J06	6AC	J48	48AC
				J65	65AC
				K20	120AC
				L40	240AC

**8 TERMINAL**

- 1<sup>10</sup> Stud 10-32, threaded
- 2<sup>11</sup> Screw 10-32
- 3<sup>12</sup> Stud 1/4-20, threaded
- 4<sup>11</sup> Stud M5 x 0.8, threaded
- 5<sup>11</sup> Screw M5 x 0.8
- 6<sup>12</sup> Stud M6, threaded
- 7<sup>13</sup> 0.250 Double Quick Connect
- 8 1/4" Clip Terminal
- 9 7/16" Clip Terminal
- A<sup>14</sup> Plug-In Stud
- C 5/16" Clip Terminal

**9 ACTUATOR COLOR & LEGEND<sup>15,17,18</sup>**

Actuator or Visi-Color	Marking:	Marking Color:
Color:	I-O	ON-OFF
	A B	Dual/None
White	C	1
	D	2
Black	F	3
	G	4
Red	H	5
	J	6
Green	K	7
	L	8
Blue	M	9
	N	10
Yellow	P	11
	Q	12
Gray	R	13
	S	14
Orange		15
		16

**10 MOUNTING/BARRIERS<sup>1</sup>**

	Standard Rocker Bezel	BARRIERS	VOLTAGE
1	6-32 x 0.195 inches	no	< 300
2	6-32 x 0.195 inches	yes	< 300
3 <sup>19</sup>	6-32 x 0.195 inches	yes	≥ 300
4	ISO M3 x 5mm	no	< 300
5	ISO M3 x 5mm	yes	< 300
6 <sup>19</sup>	ISO M3 x 5mm	yes	≥ 300
	<b>Rockerguard Bezel</b>		
7	6-32 x 0.195 inches	no	< 300
8	6-32 x 0.195 inches	yes	< 300
9	6-32 x 0.195 inches	yes	≥ 300
A	ISO M3 x 5mm	no	< 300
C	ISO M3 x 5mm	yes	< 300
E	ISO M3 x 5mm	yes	≥ 300
	<b>Push-To-Reset Bezel</b>		
B	6-32 x 0.195 inches	no	< 300
D	6-32 x 0.195 inches	yes	< 300
H <sup>19</sup>	6-32 x 0.195 inches	yes	≥ 300
F	ISO M3 x 5mm	no	< 300
J	ISO M3 x 5mm	yes	< 300
M <sup>19</sup>	ISO M3 x 5mm	yes	≥ 300

**11 AGENCY APPROVAL**

- C UL Recognized, CSA Accepted
- E TUV Certified, UL Recognized, CSA Accepted
- I UL Rec. STD 1077, UL Rec. 1500 (ignition protected), CSA Accepted
- L UL489 Construction: UL Recognized, CSA Accepted
- R UL489 Construction: TUV Certified, UL Recognized, CSA Accepted

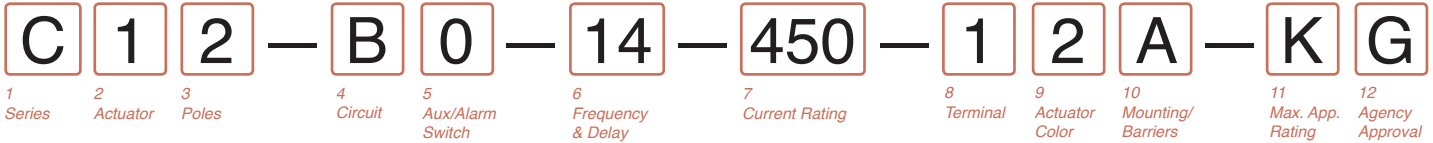

**1 SERIES**  
C

**2 ACTUATOR<sup>1</sup>**

**Two Color Visi-Rocker**

- 1 Indicate OFF, vertical legend
- 2 Indicate OFF, horizontal legend

**Single color**

- 3 Vertical legend
- 4 Horizontal legend

**Push-To-Reset, Visi-Rocker**

- 5 Indicate OFF, vertical legend
- 6 Indicate OFF, horizontal legend

**Push-To-Reset, Single color**

- 7 Vertical legend
- 8 Horizontal legend

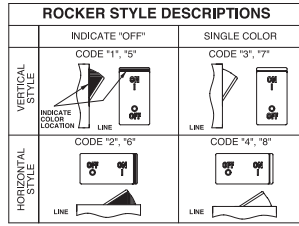

**3 POLES<sup>2</sup>**

- 1 One
- 2 Two
- 3 Three

**4 CIRCUIT**

- B Series Trip (current)

**5 AUXILIARY/ALARM SWITCH<sup>2</sup>**

- 0 w/o Aux Switch
- 2 S.P.D.T., 0.110 Q.C. Term.
- 3 S.P.D.T., 0.139 Solder Lug
- 4 S.P.D.T., 0.110 Q.C. Term. (Gold Contacts)
- 5 S.P.S.T., 0.110 Q.C. Term. (Gold Contacts)
- 6 S.P.S.T., 0.139 Solder Lug
- 7 S.P.S.T., 0.110 Q.C. Term. (Gold Contacts)
- 8 S.P.S.T., 0.187 Q.C. Term.
- 9 S.P.D.T., 0.187 Q.C. Term.

**6 FREQUENCY & DELAY**

- 11 DC Ultra Short
- 12 DC Short
- 14 DC Medium
- 16 DC Long
- 21 50/60Hz Ultra Short
- 22 50/60Hz Short
- 24 50/60Hz Medium
- 26 50/60Hz Long
- 42<sup>4</sup> 50/60Hz Short, Hi-Inrush
- 44<sup>4</sup> 50/60Hz Medium, Hi-Inrush
- 46<sup>4</sup> 50/60Hz Long, Hi-Inrush
- 52<sup>4</sup> DC Short, Hi-Inrush
- 54<sup>4</sup> DC Medium, Hi-Inrush
- 56<sup>4</sup> DC Long, Hi-Inrush

Notes:

- 1 Push-to-reset actuators have OFF portion of rocker shrouded.
- 2 Multi-pole breakers have all breakers identical except when specifying Aux. switch and/or mixed poles, and have one rocker per breaker.
- 3 On multi-pole breakers, one aux. switch is supplied, mounted in the extreme right pole.
- 4 Available up to 50 amps maximum.
- 5 Current ratings 71 - 100 with VDE approvals are available up to two poles maximum.
- 6 Terminal Code 1 available to 60 amps maximum.
- 7 Terminal Codes 2, 4, 5 & C available to 50 amps maximum.
- 8 Terminal Codes 3, 6, 9 & A available to 100 amps maximum.
- 9 Terminal Codes 8, 9 & C are not VDE approved.
- 10 Color shown is visi and legend with remainder of rocker black
- 11 Dual = ON-OFF/I-O legend on actuator.
- 12 VDE and TUV approval requires Dual (I-O, ON-OFF) markings on rocker.
- 13 Legend on push-to-reset bezel/shroud is white when single color rocker is ordered. Legend on push-to-reset bezel/shroud matches visi-color of rocker with actuator codes 5 & 6.
- 14 Recessed "OFF-SIDE" available with actuator codes 1, 2, 3, & 4. Legends on rocker are available in ink stamping only.
- 15 Barriers supplied on multi-pole units only.
- 16 2 & 3 pole circuit breakers required for 120/240 AC rating.

**7 CURRENT RATING (AMPERES)<sup>5</sup>**

CODE	AMPERES				
210	0.100	295	0.950	470	7.000
215	0.150	410	1.000	475	7.500
220	0.200	512	1.250	480	8.000
225	0.250	415	1.500	485	8.500
230	0.300	517	1.750	490	9.000
235	0.350	420	2.000	495	9.500
240	0.400	522	2.250	610	10.000
245	0.450	425	2.500	710	10.500
250	0.500	527	2.750	611	11.000
255	0.550	430	3.000	711	11.500
260	0.600	435	3.500	612	12.000
265	0.650	440	4.000	712	12.500
270	0.700	445	4.500	613	13.000
275	0.750	450	5.000	614	14.000
280	0.800	455	5.500	615	15.000
285	0.850	460	6.000	616	16.000
290	0.900	465	6.500	617	17.000

**8 TERMINAL**

- 1<sup>6</sup> Stud 10-32, threaded .625 long
- 2<sup>7</sup> Screw 8-32 w/saddle & washer clamps
- 3<sup>8</sup> Stud 1/4-20, threaded .625 long
- 4<sup>7</sup> Stud M5 x 0.8, threaded .625 long
- 5<sup>7</sup> Screw M5 x 0.8 w/saddle & washer clamps
- 6<sup>8</sup> Stud M6, threaded 17mm long
- 8<sup>9</sup> 1/4" Clip Terminal
- 9<sup>8,9</sup> 7/16" Clip Terminal
- A<sup>8,9</sup> Plug-In Stud
- C<sup>7,9</sup> 5/16" Clip Terminal

**9 ACTUATOR COLOR & LEGEND<sup>12</sup>**

Actuator or Visi-Color <sup>9</sup>	Marking:	Marking Color:
<b>Color:</b>	<b>ON-OFF</b>	<b>Dual<sup>11</sup></b>
	<b>Single Color Rocker/Handle</b>	<b>Visi-Rocker</b>
White	B	1
Black	D	2
Red	G	3
Green	J	4
Blue	L	5
Yellow	N	6
Gray	Q	7
Orange	S	8

**10 MOUNTING/BARRIERS<sup>12</sup>**

	Standard Rocker Bezel Threaded Insert, 2 per pole	BARRIERS <sup>15</sup>
A	6-32 x 0.195 inches	yes
C	ISO M3 x 5mm	yes
	<b>Recessed Off Rocker<sup>14</sup></b> Threaded Insert, 2 per pole	
E	6-32 x 0.195 inches	yes
F	ISO M3 x 5mm	yes
	<b>Push-To-Reset Bezel</b> Threaded Insert, 2 per pole	
B	6-32 x 0.195 inches	yes
D	ISO M3 x 5mm	yes

**11 MAXIMUM APPLICATION RATING**

- A 65 DC
- B 125 DC
- C 120/240 AC<sup>16</sup>
- D 240 AC
- K 120 AC
- M 80 DC

**12 AGENCY APPROVAL**

- A without approvals
- G UL 489 Listed & CSA Certified
- J UL489 Listed, CSA Certified & TUV Certified

DESCRIPTION	CODE	DIMENSIONAL DETAIL	RATING (AMPS)		
			25	50	100
#10-32 STUD	1				
M5 STUD	4				
#1/4-20 STUD	3				
M6 STUD	6				
#1/4-20 STUD	3				
M6 STUD	6				
#10-32 SCREW	2				
M-5 SCREW	5				

DESCRIPTION	CODE	DIMENSIONAL DETAIL	RATING (AMPS)		
			25	50	100
.250 DOUBLE Q.C.	7				
7/16" CLIP TERMINALS	9				
PUSH-IN STUD	A				

NOTES: TOLERANCE ON STUD LENGTHS IS ±.031 [±.79] UNLESS OTHERWISE SPECIFIED.

AUXILIARY / ALARM SWITCH TERMINAL DETAIL<sup>3</sup>

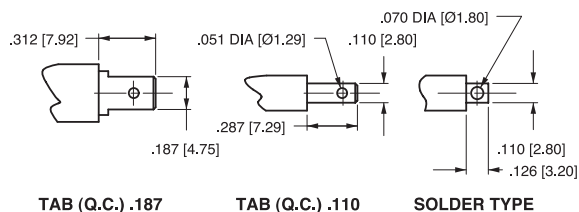

TIGHTENING TORQUE SPECIFICATIONS	
THREAD SIZE	TORQUE
#6-32 [M3] MOUNTING INSERTS	7-9 IN-LBS [0.8-1.0 NM]
#10-32 & M5 THD STUDS	15-20 IN-LBS [1.7-2.3 NM]
#10-32 THD SCREW	15-20 IN-LBS [1.7-2.3 NM]
#1/4-20 & M6 THD STUDS	30-35 IN-LBS [3.4-4.0 NM]

TERMINAL HARDWARE				
TERMINAL DESCRIPTION	CODE	AGENCY APPROVAL	AMPERE RATING	HARDWARE SUPPLIED
#10-32 STUD	1	ALL	.02 - 50	LOCK WASHER - FLAT WASHER - NUT
M5 STUD	4	ALL	.02 - 50	LOCK WASHER - FLAT WASHER - NUT
#1/4-20 STUD	3	ALL	.02 - 80	LOCK WASHER - FLAT WASHER - NUT
			81 - 100	LOCK WASHER - NUT - (2)FLAT WASHER - NUT
M6 STUD	6	ALL	.02 - 80	LOCK WASHER - FLAT WASHER - NUT
			81 - 100	LOCK WASHER - NUT - (2)FLAT WASHER - NUT
#10-32 SCREW	2 & 5	UL RECOGNIZED	.02 - 50	* SADDLE CLAMP - FLAT WASHER - SCREW
		UL-489 LISTED	.02 - 50	LOCK WASHER - FLAT WASHER - SCREW
		TUV & VDE CERTIFIED	.02 - 16	* SADDLE CLAMP - FLAT WASHER - SCREW
		TUV & VDE CERTIFIED	16.1 - 50	LOCK WASHER - FLAT WASHER - SCREW

\* THE SADDLE CLAMP IS FOR DIRECT WIRE CONNECTION USE. DISCARD SADDLE CLAMP IF WIRE TERMINAL LUG IS USED

- Notes:  
 1 All dimensions are in inches [millimeters].  
 2 Tolerance ±.020 [.51] unless otherwise specified.  
 3 Available on Series Trip and Switch Only Circuits when called for on multi-pole units. Only one aux. switch is normally supplied, as viewed in multi-pole identification scheme.

CIRCUIT SCHEMATIC	CIRCUIT SCHEMATIC		CIRCUIT CODE	AUX SWITCH CODE	CIRCUIT SCHEMATIC		CIRCUIT CODE	AUX SWITCH CODE
	ANSI	IEC			ANSI	IEC		
			LINE	O			B	O
			LOAD	2 3 4			B	2 3 4
			D	0			H	0
			F	G			K	0

HANDLE POSITION VS. AUX/ALARM SWITCH MODE					
CIRCUIT BREAKER MODE	STANDARD C/B		MID TRIP C/B		
	HANDLE POSITION	AUX. SWITCH MODE	HANDLE POSITION	STANDARD ALARM SWITCH MODE	REVERSE ALARM SWITCH MODE <sup>4</sup>
OFF					
ON					
ELECTRICAL TRIP					

Notes:

- 1 All dimensions are in inches [millimeters].
- 2 Tolerance  $\pm .020$  [.51] unless otherwise specified.
- 3 Schematic shown represents current trip circuits.
- 4 Available only as special catalog number.



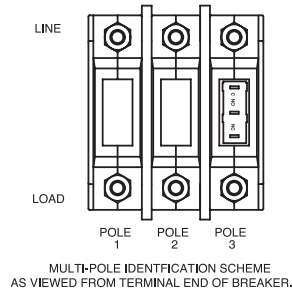
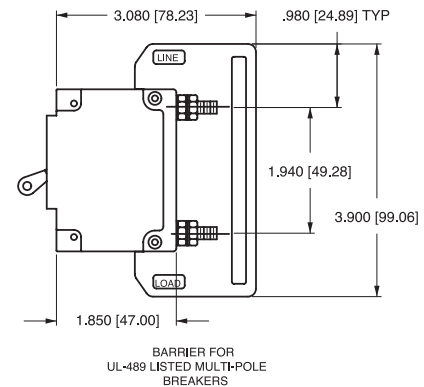
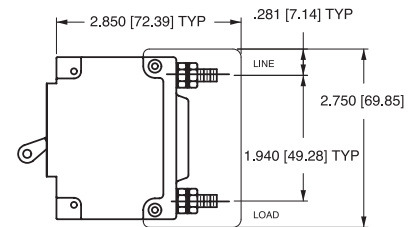
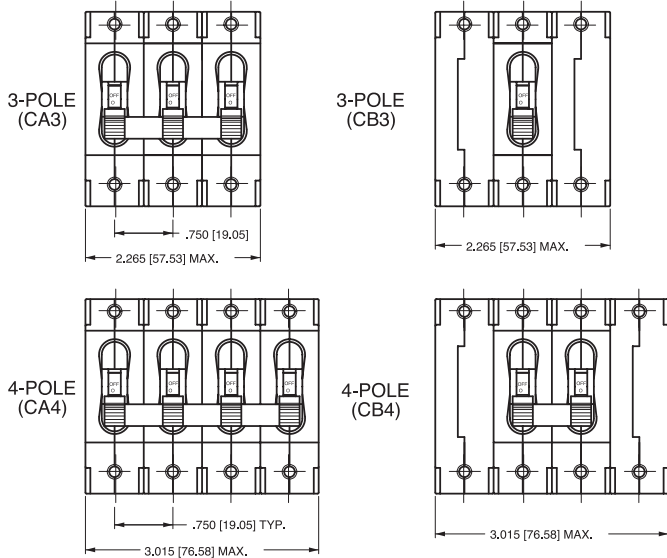
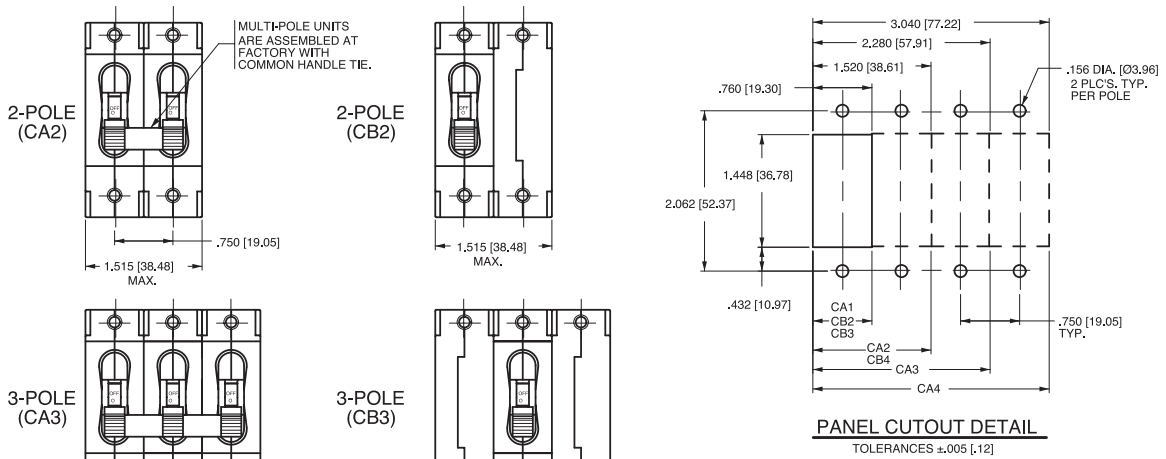
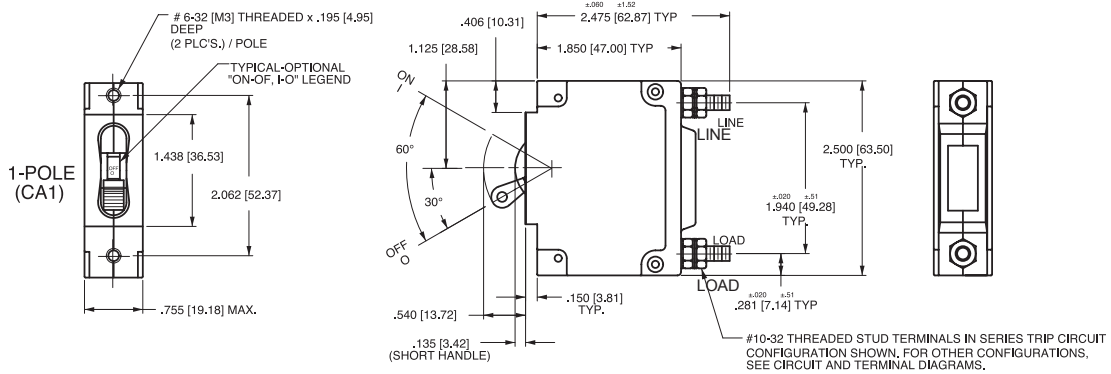

- Notes:
- 1 All dimensions are in inches [millimeters].
  - 2 Tolerance ±.020 [.51] unless otherwise specified.

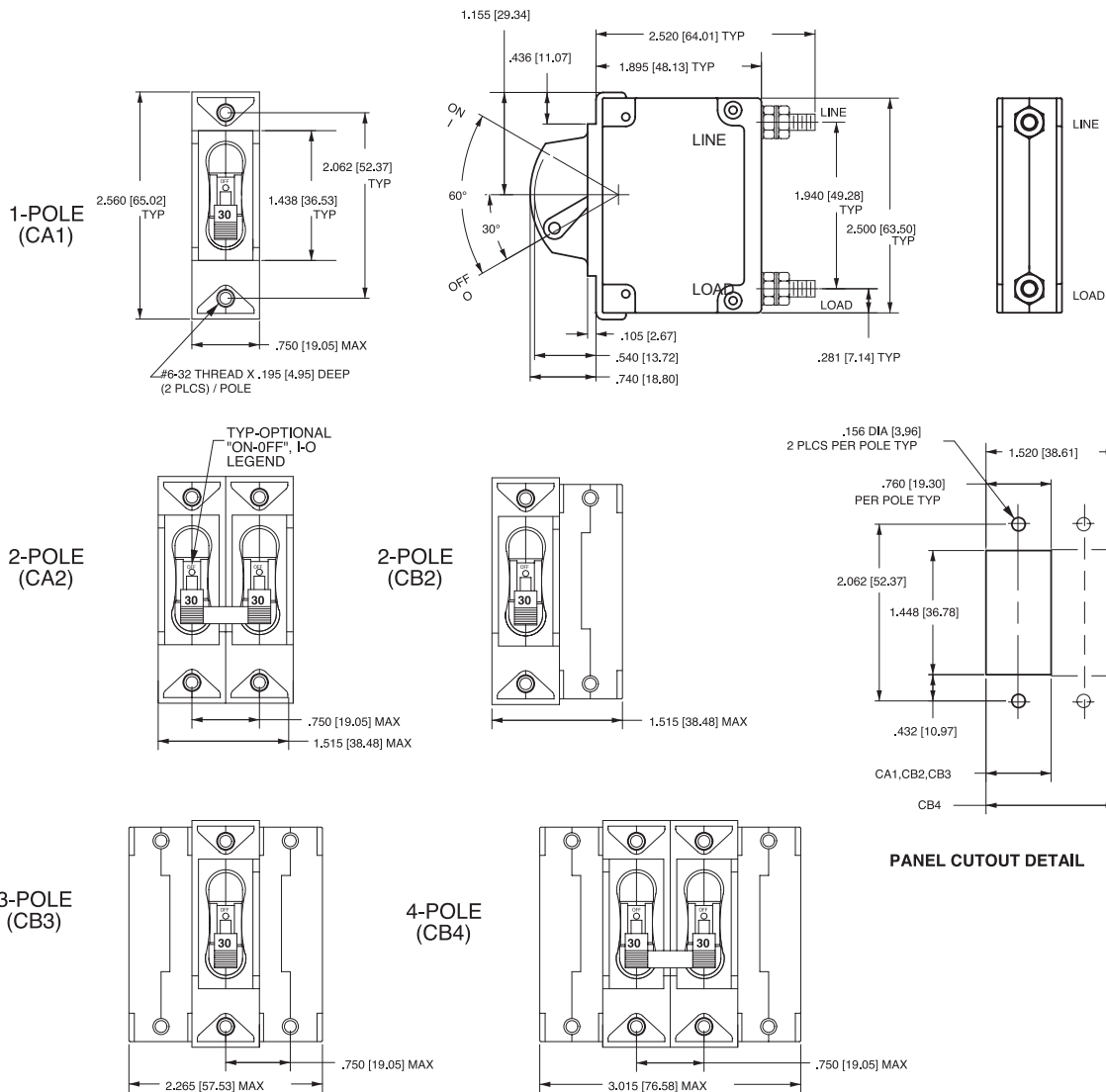

\*Handleguard available as special catalog number only

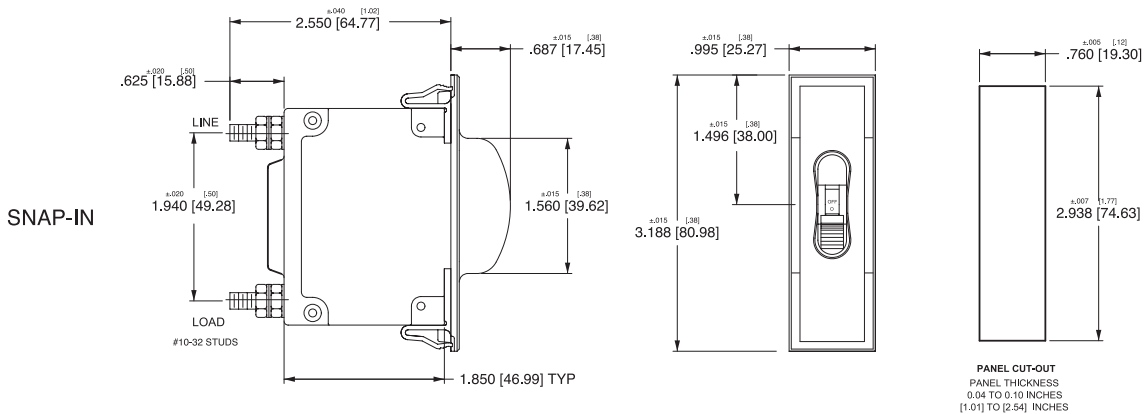

- Notes:  
 1 All dimensions are in inches [millimeters].  
 2 Tolerance  $\pm 0.020$  [.51] unless otherwise specified.

**PARALLEL POLE  
(CA2-P)**

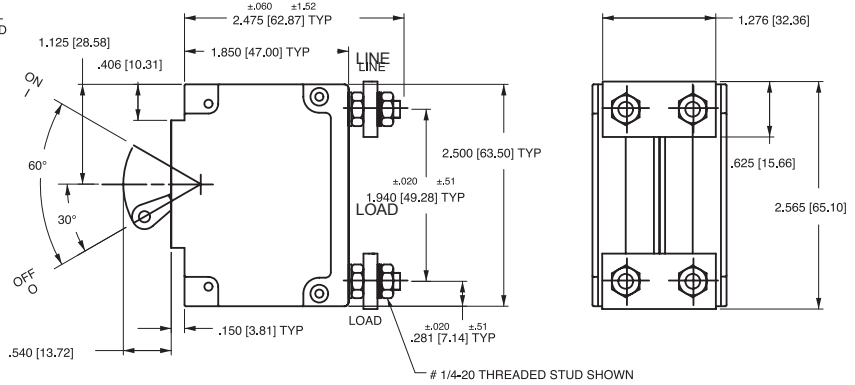
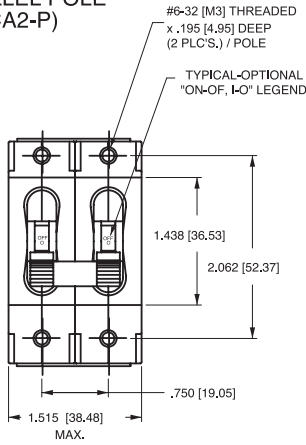

**PARALLEL POLE  
(CA3-P)**

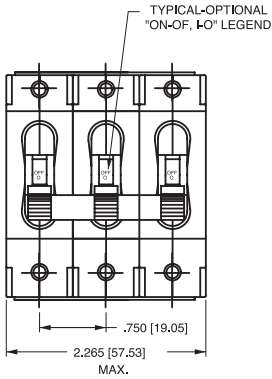

CIRCUIT BREAKER PROFILE	CIRCUIT SCHEMATIC (CA2-P SHOWN)		CIRCUIT CODE	AUX SWITCH CODE
	ANSI	IEC		
	<b>SERIES TRIP</b> 		P	0
	<b>SERIES TRIP WITH AUXILIARY SWITCH</b> 		P	2 3 4

**TERMINAL DETAILS**

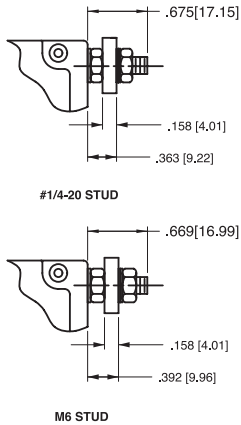
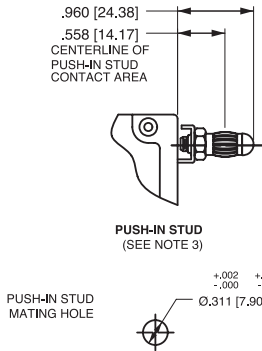

**PANEL CUTOUT DETAIL**

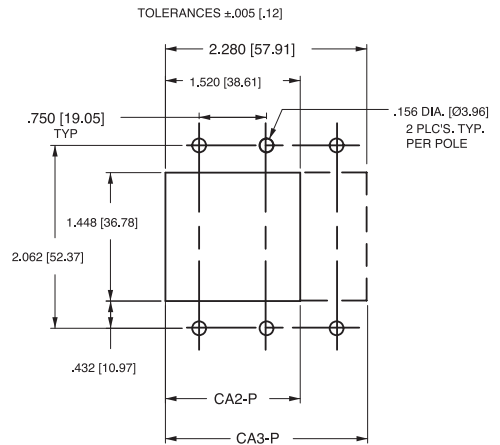

- Notes:
- 1 All dimensions are in inches [millimeters].
  - 2 Tolerance ±.020 [.51] unless otherwise specified.

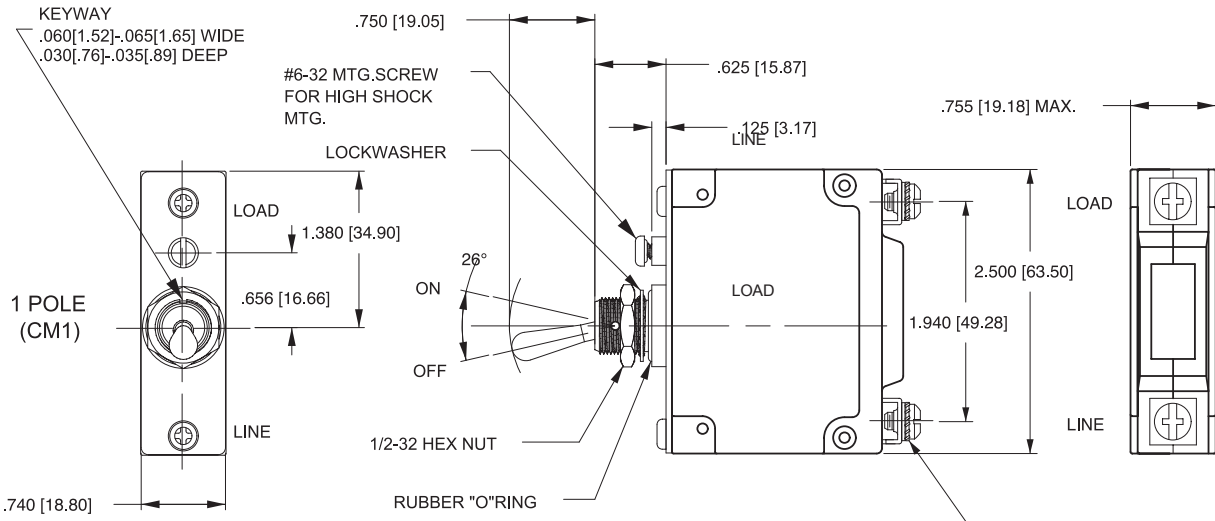

SCREW TYPE TERMINALS IN SERIES TRIP CIRCUIT CONFIGURATION SHOWN. FOR OTHER CONFIGURATIONS SEE CIRCUIT & TERMINAL DIAGRAMS

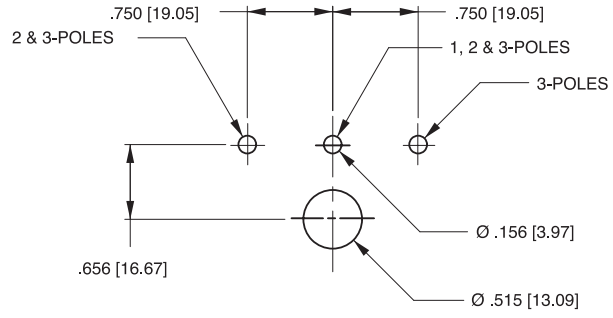
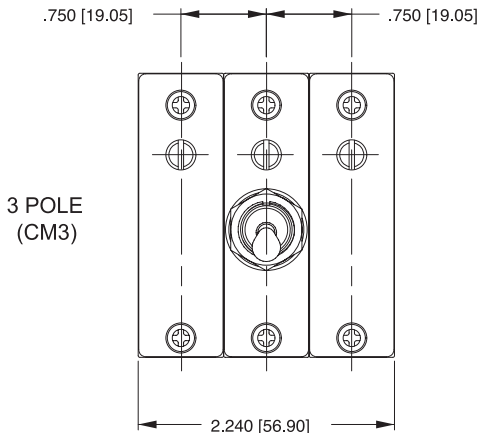
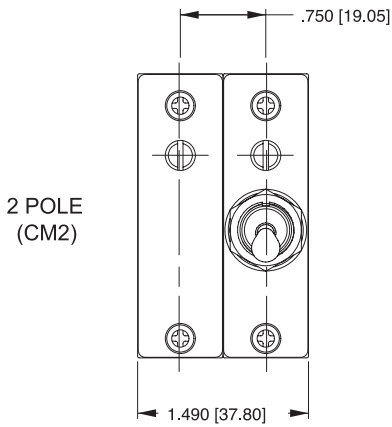

PANEL CUTOUT DETAIL  
TOLERANCES ±.005[.13]

- Notes:
- 1 All dimensions are in inches [millimeters].
  - 2 Tolerance ±.020 [.51] unless otherwise specified.

CIRCUIT BREAKER PROFILE	CIRCUIT SCHEMATIC		CIRCUIT CODE	AUX. SWITCH CODE	CIRCUIT SCHEMATIC		CIRCUIT CODE	AUX. SWITCH CODE
	ANSI	IEC			ANSI	IEC		
<p>SERIES TRIP (2 TERMS.)</p>	<p>SWITCH ONLY (NO COIL)</p>		LINE	0	<p>SWITCH TRIP</p>		BC	0
<p>SERIES TRIP W/AUX. SWITCH (5 TERMS.)</p>	<p>SWITCH ONLY (NO COIL) WITH AUXILIARY SWITCH</p>		LOAD	2 3 4	<p>SERIES TRIP WITH AUXILIARY SWITCH</p>		BC	2 3 4
<p>SHUNT TRIP (3 TERMS.)</p>	<p>SHUNT TRIP</p>		DE	0	<p>DUAL COIL; SERIES TRIP CURRENT COIL, SHUNT TRIP VOLTAGE COIL</p>		H	0
<p>SHUNT TRIP (4 TERMS.)</p>	<p>RELAY TRIP</p>		FG	0	<p>DUAL COIL; SERIES TRIP CURRENT COIL, RELAY TRIP VOLTAGE COIL</p>		K	0

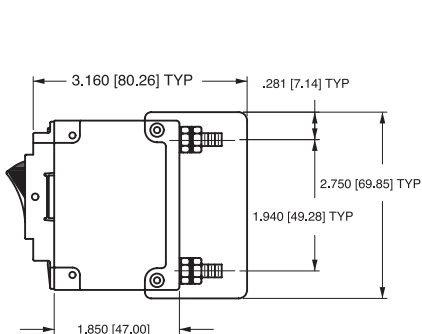

BARRIER FOR UL-RECOGNIZED MULTI-POLE BREAKERS

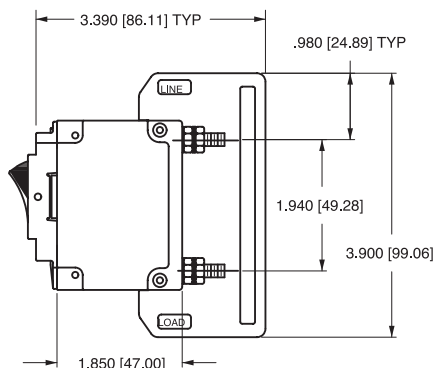

BARRIER FOR UL-489 LISTED MULTI-POLE BREAKERS

Notes:

- 1 All dimensions are in inches [millimeters].
- 2 Tolerance  $\pm .020$  [.51] unless otherwise specified.
- 3 Schematic shown represents current trip circuit.

**INDICATE "ON"**

SCREW TYPE TERMINALS IN SERIES TRIP CIRCUIT CONFIGURATION SHOWN, FOR OTHER CONFIGURATIONS SEE CIRCUIT AND TERMINAL DIAGRAMS.

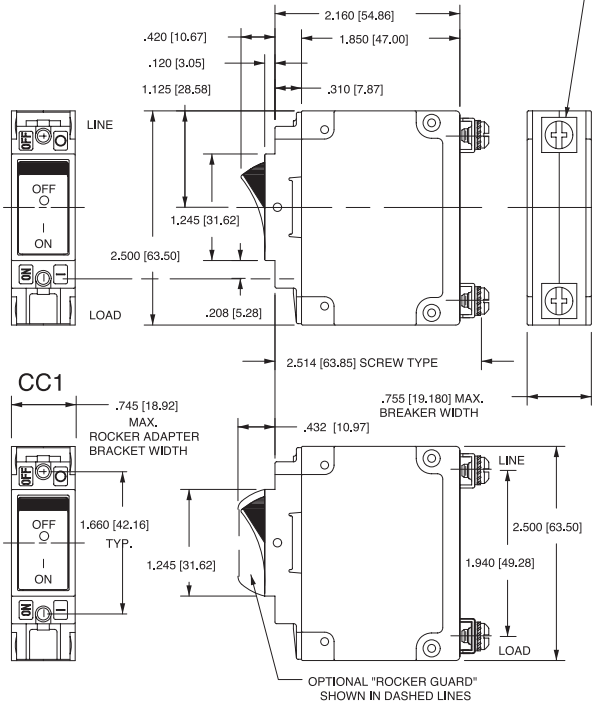

**INDICATE "OFF" & SINGLE COLOR**

(INDICATE "OFF" SHOWN)

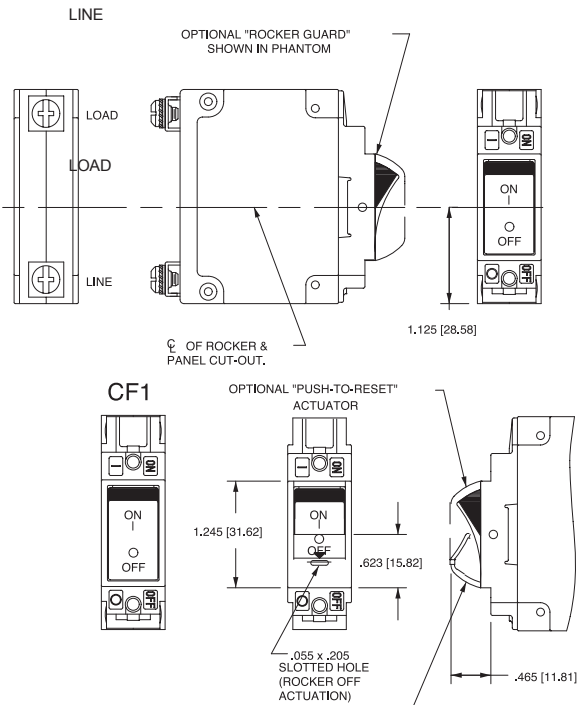

**CC1**

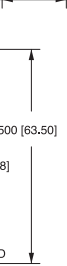
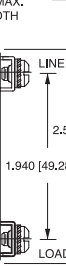
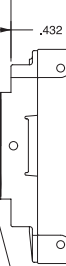
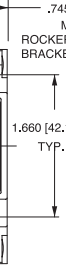

**CF1**

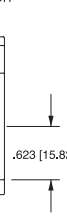
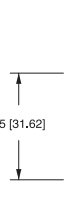

**CC2**

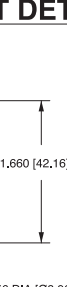
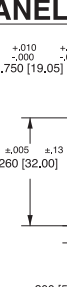
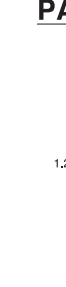
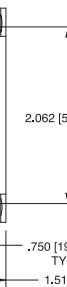

**PANEL CUT-OUT DETAIL**

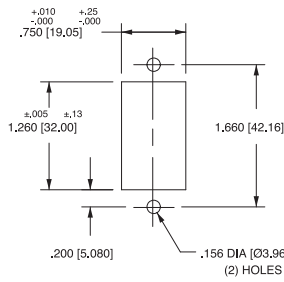

**CC3**

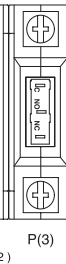
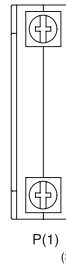
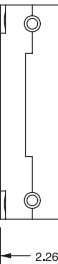

**CF2**



**CF3**

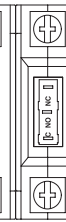
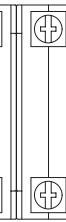
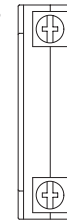

REAR VIEW OF INDICATE "ON" SERIES TRIP W/ AUX SWITCH CIRCUIT CONFIGURATION.

REAR VIEW OF INDICATE "OFF" SERIES TRIP W/ AUX SWITCH CIRCUIT CONFIGURATION.

**Notes:**

- 1 Dimensions apply to all variations shown. Notice that circuit breaker line and load terminal orientation on indicate OFF is opposite of indicate ON.
- 2 For pole orientation with horizontal legend, rotate front view clockwise 90°.
- 3 All dimensions are in inches [millimeters].
- 4 Tolerance ±.020 [.51] unless otherwise specified.

INDICATE "OFF" & SINGLE COLOR

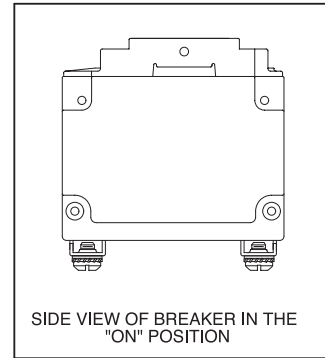
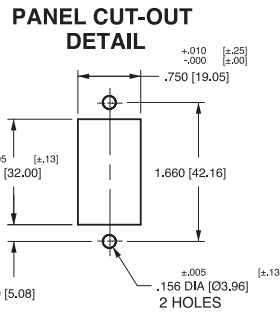
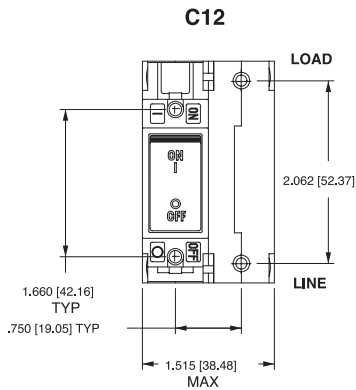
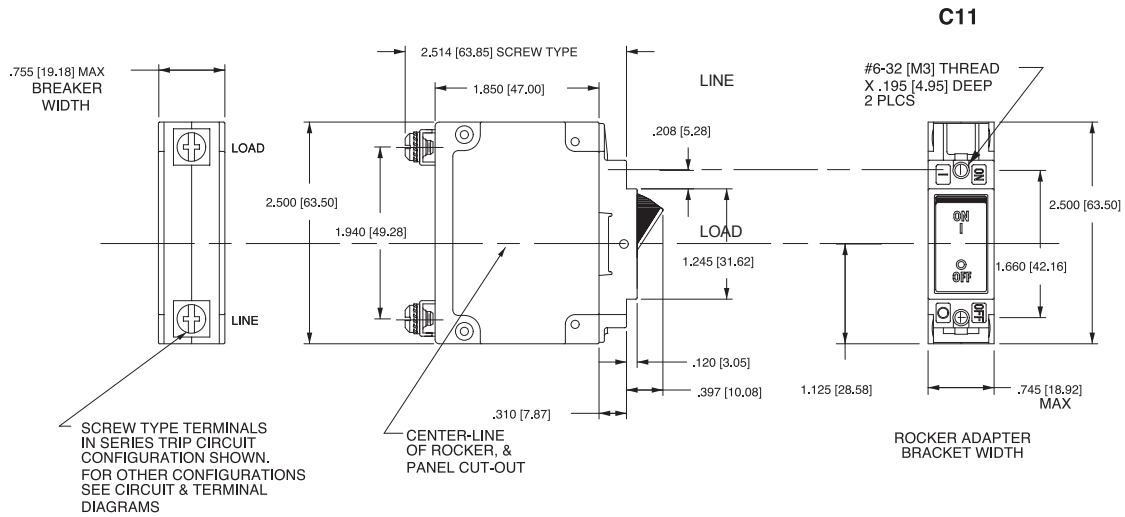

**PUSH-TO-RESET ACTUATOR**

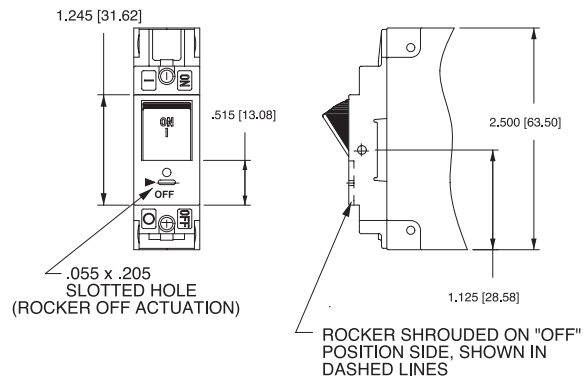
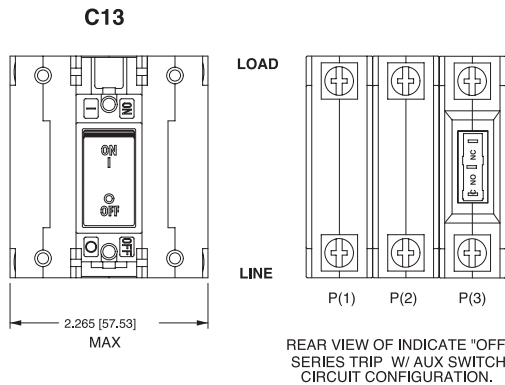

**ACTUATOR SIDE VIEW (SURFACE CONTOURS)**

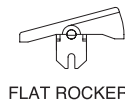

- Notes:
- 1 For pole orientation with horizontal legend, rotate front view clockwise 90°.
  - 2 All dimensions are in inches [millimeters].
  - 3 Tolerance  $\pm .020$  [.51] unless otherwise specified.

### **Worldwide Headquarters**

Carling Technologies, Inc.  
60 Johnson Avenue • Plainville, CT 06062-1177  
Phone: (860) 793-9281 • Fax: (860) 793-9231  
Email: sales@carlingtech.com • www.carlingtech.com

East Region Sales Office, CT • ersm@carlingtech.com  
Midwest Region Sales Office, IL • mrs@carlingtech.com  
West Region Sales Office, CA • wrsm@carlingtech.com

### **Asia-Pacific Headquarters**

Carling Technologies, Asia-Pacific Ltd.,  
Kowloon, Hong Kong  
Int + 852-2737-2277 • Fax: Int + 852-2736-9332  
Email: sales@carlingtech.com.hk

Shenzhen, China • shenzhen@carlingtech.com  
Shanghai, China • shanghai@carlingtech.com  
Pune, India • india@carlingtech.com  
Kaohsiung, Taiwan • taiwan@carlingtech.com  
Yokohama, Japan • japan@carlingtech.com

### **Europe / Middle East / Africa Headquarters**

Carling Technologies, Ltd.,  
Devon, England 06062-1177  
Int + 44 1392-364422 • Fax: Int + 44 1392-364477  
Email: ltd.sales@carlingtech.com

GmbH, Germany • gmbh@carlingtech.com  
SAS, France • sas@carlingtech.com

REV\_CB\_C\_0312



**Carling Technologies™**

Innovative Designs. Powerful Solutions.

Innovative Designs. Powerful Solutions.