

EVALUATION KIT  
AVAILABLE

# MAXIM

## 330MHz, Gain of +1/Gain of +2 Closed-Loop Buffers

MAX4178/MAX4278

### General Description

The MAX4178/MAX4278 are  $\pm 5V$ , wide-bandwidth, fast-settling, closed-loop buffers featuring high slew rate, high precision, high output current, low noise, and low differential gain and phase errors. The MAX4178, with a -3dB bandwidth of 330MHz, is preset for unity voltage gain (0dB). The MAX4278 is preset for a voltage gain of +2 (6dB) and has a 310MHz -3dB bandwidth.

The MAX4178/MAX4278 feature the high slew rate and low power that are characteristic of current-mode feedback amplifiers. However, unlike conventional current-mode feedback amplifiers, these devices have a unique input stage that combines the benefits of current-feedback topology with those of the traditional voltage-feedback topology. This combination results in low input offset voltage and bias current, low noise, and high gain precision and power-supply rejection.

The MAX4178/MAX4278 are ideally suited for driving  $50\Omega$  or  $75\Omega$  loads. They are the perfect choice for high-speed cable-driving applications, such as video routing. The MAX4178/MAX4278 are available in DIP, SO, space-saving  $\mu$ MAX, and SOT23 packages.

### Applications

Broadcast and High-Definition TV Systems  
Video Switching and Routing  
High-Speed Cable Drivers  
Communications  
Medical Imaging  
Precision High-Speed DAC/ADC Buffers

### Typical Operating Circuit

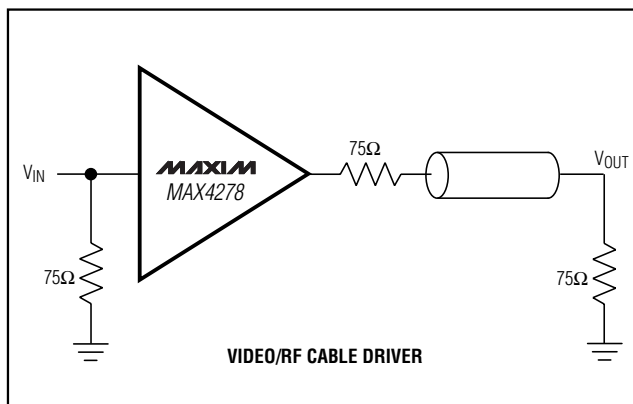

### Features

- ◆ High Speed
  - 330MHz -3dB Bandwidth (MAX4178)
  - 310MHz -3dB Bandwidth (MAX4278)
  - 250MHz Full-Power Bandwidth ( $V_{OUT} = 2V_{p-p}$ )
  - 150MHz 0.1dB Flatness Bandwidth
  - 1300V/ $\mu$ s Slew Rate (MAX4178)
  - 1600V/ $\mu$ s Slew Rate (MAX4278)
- ◆ Low Differential Phase/Gain Error: 0.01°/0.04%
- ◆ 8mA Supply Current
- ◆ 1 $\mu$ A Input Bias Current
- ◆ 0.5mV Input Offset Voltage
- ◆ 5nV/ $\sqrt{Hz}$  Input-Referred Voltage Noise
- ◆ 2pA/ $\sqrt{Hz}$  Input-Referred Current Noise
- ◆ 1.0% Max Gain Error with 100 $\Omega$  Load
- ◆ Short-Circuit Protected
- ◆ 8000V ESD Protection
- ◆ Available in Space-Saving SOT23 Package

### Ordering Information

PART	TEMP. RANGE	PIN-PACKAGE	SOT TOP MARK
MAX4178EPA	-40°C to +85°C	8 Plastic DIP	—
MAX4178ESA	-40°C to +85°C	8 SO	—
MAX4178EUA	-40°C to +85°C	8 $\mu$ MAX	—
MAX4178EUK-T	-40°C to +85°C	5 SOT23-5	ABYX
MAX4178MJA	-55°C to +125°C	8 CERDIP	—

Ordering Information continued at end of data sheet.

### Pin Configurations

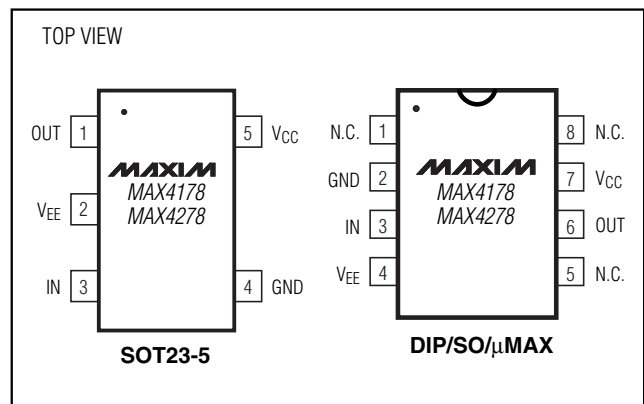

MAXIM

Maxim Integrated Products 1

For pricing, delivery, and ordering information, please contact Maxim/Dallas Direct! at 1-888-629-4642, or visit Maxim's website at [www.maxim-ic.com](http://www.maxim-ic.com).

# 330MHz, Gain of +1/Gain of +2 Closed-Loop Buffers

## ABSOLUTE MAXIMUM RATINGS

Supply Voltage (V <sub>CC</sub> to V <sub>EE</sub> )	12V
Input Voltage	(V <sub>CC</sub> + 0.3V) to (V <sub>EE</sub> - 0.3V)
Output Short-Circuit Duration (to GND)	Continuous
Continuous Power Dissipation (T <sub>A</sub> = +70°C)	
SOT23 (derate 7.10mW/°C above +70°C)	571mW
Plastic DIP (derate 9.09mW/°C above +70°C)	727mW
SO (derate 5.88mW/°C above +70°C)	471mW
μMAX (derate 4.10mW/°C above +70°C)	330mW
CERDIP (derate 8.00mW/°C above +70°C)	640mW

### Operating Temperature Ranges (Note 1)

MAX4178E_A/MAX4278E_A	-40°C to +85°C
MAX4178EUK/MAX4278EUK	-40°C to +85°C
MAX4178MJA/MAX4278MJA	-55°C to +125°C
Storage Temperature Range	-65°C to +160°C
Lead Temperature (soldering, 10s)	+300°C

**Note 1:** Specifications for the MAX4\_78EUK (SOT23 packages) are 100% tested at T<sub>A</sub> = +25°C, and guaranteed by design over temperature.

Stresses beyond those listed under "Absolute Maximum Ratings" may cause permanent damage to the device. These are stress ratings only, and functional operation of the device at these or any other conditions beyond those indicated in the operational sections of the specifications is not implied. Exposure to absolute maximum rating conditions for extended periods may affect device reliability.

## DC ELECTRICAL CHARACTERISTICS

(V<sub>CC</sub> = +5V, V<sub>EE</sub> = -5V, V<sub>OUT</sub> = 0, R<sub>L</sub> = ∞, T<sub>A</sub> = T<sub>MIN</sub> to T<sub>MAX</sub>, unless otherwise noted. Typical values are at T<sub>A</sub> = +25°C.)

PARAMETER	SYMBOL	CONDITIONS		MIN	TYP	MAX	UNITS	
Input Voltage Range	V <sub>IN</sub>	MAX4178		±2.5	±3.0		V	
		MAX4278		±1.25	±1.5			
Input Offset Voltage	V <sub>OS</sub>	T <sub>A</sub> = +25°C	MAX4_78ESA/EPA/EUA/MJA		0.5	2.0	mV	
			MAX4_78EUK		0.5	3.0		
		T <sub>A</sub> = T <sub>MIN</sub> to T <sub>MAX</sub>	MAX4_78ESA/EPA/EUA/MJA			3.0		
			MAX4_78EUK			5.0		
Input Offset Voltage Drift	TCV <sub>OS</sub>				2		μV/°C	
Input Bias Current	I <sub>B</sub>	T <sub>A</sub> = +25°C			1	3	μA	
		T <sub>A</sub> = T <sub>MIN</sub> to T <sub>MAX</sub>				5		
Input Resistance	R <sub>IN</sub>				1		MΩ	
Power-Supply Rejection Ratio	PSRR	V <sub>S</sub> = ±4.5V to ±5.5V		70	90		dB	
Voltage Gain	A <sub>v</sub>	MAX4178 (Note 2)	R <sub>L</sub> = 100Ω	+0.990		+1.000	V/V	
			R <sub>L</sub> = 50Ω	+0.985		+1.000		
		MAX4278 (Note 3)	R <sub>L</sub> = 100Ω	+1.98		+2.01		
			R <sub>L</sub> = 50Ω	+1.97		+2.01		
Gain Linearity	A <sub>V(LIN)</sub>	V <sub>OUT</sub> = ±1mV to ±2V			0.01		%	
Output Resistance	R <sub>OUT</sub>	f = DC			0.1		Ω	
Minimum Output Current	I <sub>OUT</sub>	T <sub>A</sub> = -40°C to +85°C		70	100		mA	
Short-Circuit Output Current	I <sub>SC</sub>	Short to GND			150		mA	
Output Voltage Swing	V <sub>OUT</sub>	R <sub>L</sub> = 100Ω		±2.5	±3.0		V	
		R <sub>L</sub> = 50Ω		±2.0	±2.5			
Quiescent Supply Current	I <sub>SY</sub>	T <sub>A</sub> = +25°C			8	10	mA	
		T <sub>A</sub> = T <sub>MIN</sub> to T <sub>MAX</sub>	MAX4_78E_ _					12
			MAX4_78MJA					14

**Note 2:** Voltage Gain = (V<sub>OUT</sub> - V<sub>OS</sub>) / V<sub>IN</sub> measured at V<sub>IN</sub> = ±2.5V.

**Note 3:** Voltage Gain = (V<sub>OUT</sub> - V<sub>OS</sub>) / V<sub>IN</sub> measured at V<sub>IN</sub> = ±1.25V.

# 330MHz, Gain of +1/Gain of +2 Closed-Loop Buffers

MAX4178/MAX4278

## AC ELECTRICAL CHARACTERISTICS

(V<sub>CC</sub> = +5V, V<sub>EE</sub> = -5V, R<sub>L</sub> = 100Ω, T<sub>A</sub> = +25°C, unless otherwise noted.)

PARAMETER	SYMBOL	CONDITIONS	MIN	TYP	MAX	UNITS
Small-Signal, -3dB Bandwidth	BW	V <sub>OUT</sub> ≤ 0.1Vp-p	MAX4178	330		MHz
			MAX4278	310		
Small-Signal, ±0.1dB Bandwidth	BW(0.1dB)	V <sub>OUT</sub> ≤ 0.1Vp-p	MAX4178	150		MHz
			MAX4278	150		
Full-Power Bandwidth	FPBW	V <sub>OUT</sub> = 2Vp-p	MAX4178	250		MHz
			MAX4278	250		
Slew Rate	SR	V <sub>OUT</sub> = ±2Vp-p	MAX4178	1300		V/μs
			MAX4278	1600		
Settling Time	t <sub>s</sub>	V <sub>OUT</sub> = 2V step	to 0.1%	10		ns
			to 0.01%	12		
Rise/Fall Times	t <sub>R</sub> , t <sub>F</sub>	V <sub>OUT</sub> = 2V step		2		ns
Input Capacitance	C <sub>IN</sub>			1		pF
Input Voltage Noise Density	e <sub>n</sub>	f = 10MHz		5		nV/√Hz
Input Current Noise Density	i <sub>n</sub>	f = 10MHz		2		pA/√Hz
Differential Gain (Note 4)	DG	f = 3.58MHz	MAX4178	0.04		%
			MAX4278	0.04		
Differential Phase (Note 4)	DP	f = 3.58MHz	MAX4178	0.01		degrees
			MAX4278	0.01		
Total Harmonic Distortion	THD	f <sub>C</sub> = 10MHz, V <sub>OUT</sub> = 2Vp-p	MAX4178	-58		dB
			MAX4278	-59		
Spurious-Free Dynamic Range	SFDR	f = 5MHz, V <sub>OUT</sub> = 2Vp-p	MAX4178	-81		dBC
			MAX4278	-74		
Third-Order Intercept	IP3	f <sub>C</sub> = 10MHz, V <sub>OUT</sub> = 2Vp-p	MAX4178	36		dBm
			MAX4278	31		

**Note 4:** Tested with a 3.58MHz video test signal with an amplitude of 40IRE superimposed on a linear ramp (0 to 100IRE). An IRE is a unit of video signal amplitude developed by the Institute of Radio Engineers; 140IRE = 1V in color systems.

# 330MHz, Gain of +1/Gain of +2 Closed-Loop Buffers

## Typical Operating Characteristics

( $V_{CC} = +5V$ ,  $V_{EE} = -5V$ ,  $R_L = 100\Omega$ ,  $C_L = 0pF$ ,  $T_A = +25^\circ C$ , unless otherwise noted.)

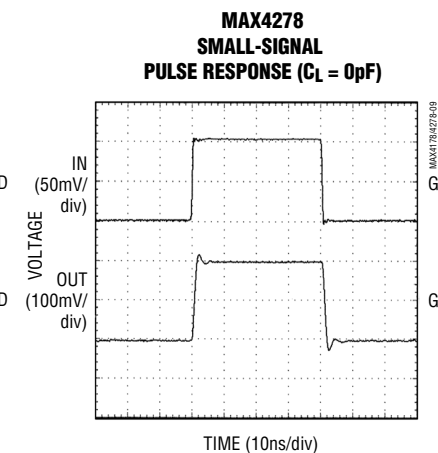
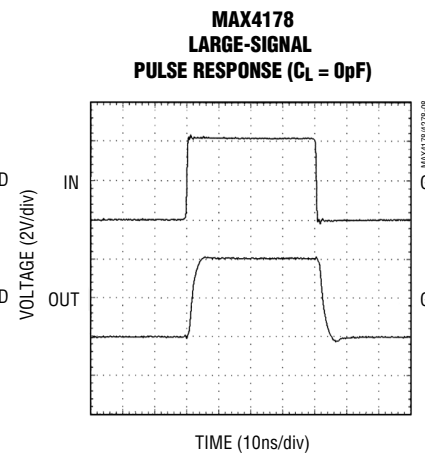
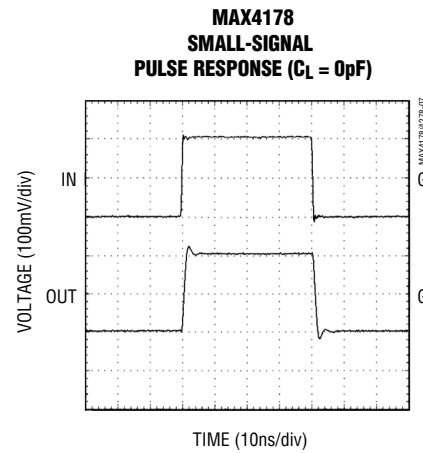
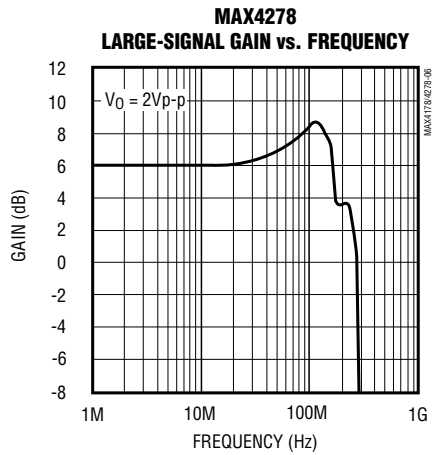
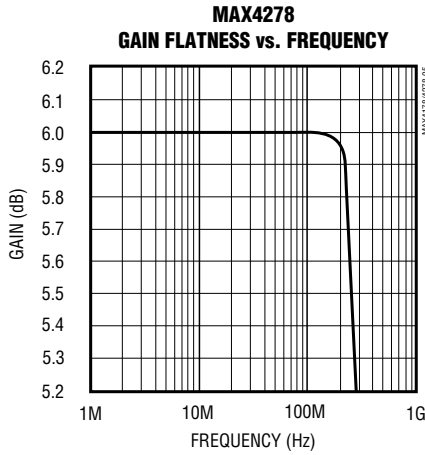
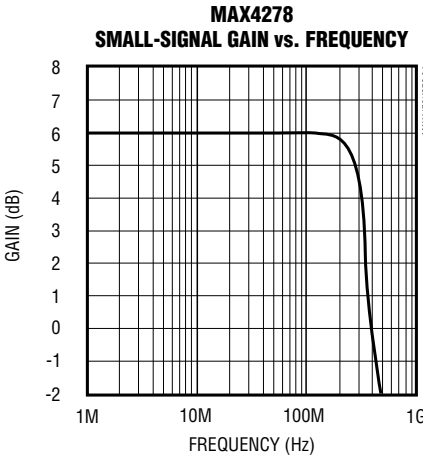
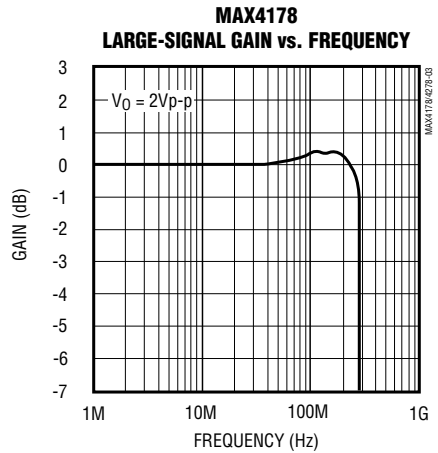
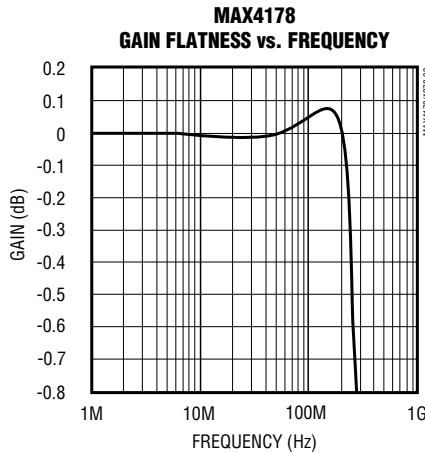
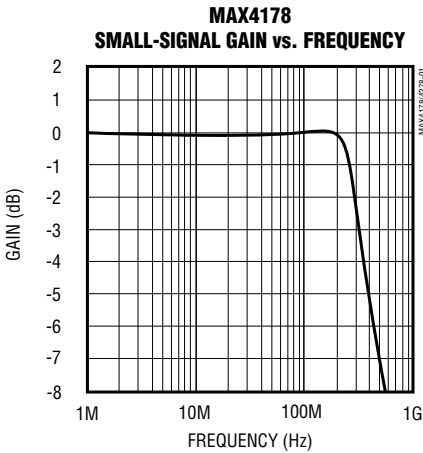

# 330MHz, Gain of +1/Gain of +2 Closed-Loop Buffers

## Typical Operating Characteristics (continued)

( $V_{CC} = +5V$ ,  $V_{EE} = -5V$ ,  $R_L = 100\Omega$ ,  $C_L = 0pF$ ,  $T_A = +25^\circ C$ , unless otherwise noted.)

**MAX4178/MAX4278**

**MAX4278  
LARGE-SIGNAL  
PULSE RESPONSE ( $C_L = 0pF$ )**

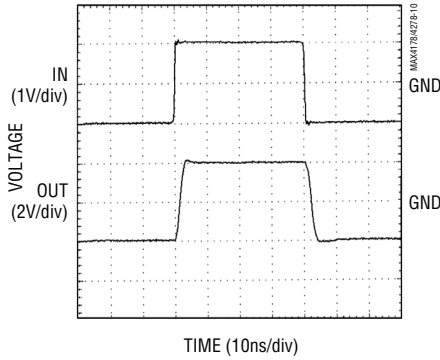

**MAX4178  
SMALL-SIGNAL  
PULSE RESPONSE ( $C_L = 50pF$ )**

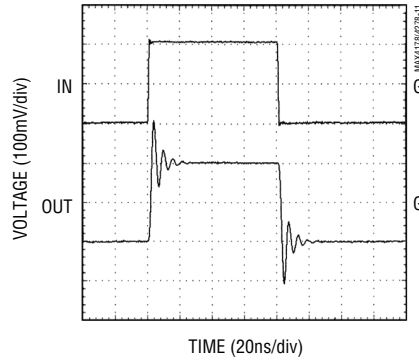

**MAX4178  
LARGE-SIGNAL  
PULSE RESPONSE ( $C_L = 50pF$ )**

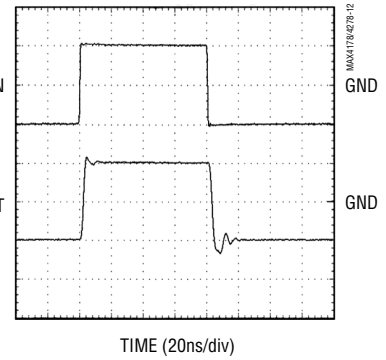

**MAX4178  
SMALL-SIGNAL  
PULSE RESPONSE ( $C_L = 100pF$ )**

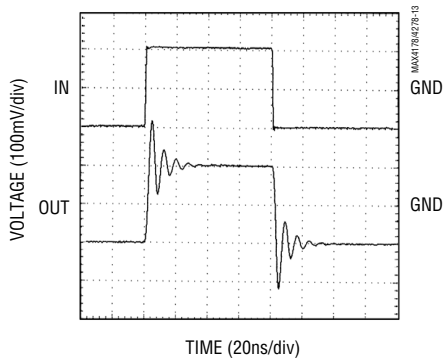

**MAX4178  
LARGE-SIGNAL  
PULSE RESPONSE ( $C_L = 100pF$ )**

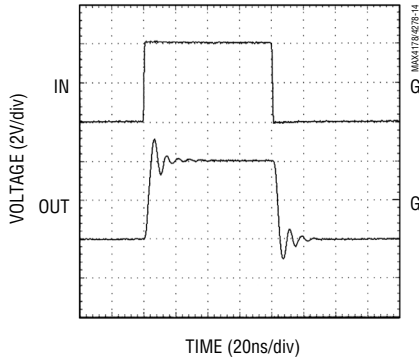

**MAX4278  
SMALL-SIGNAL  
PULSE RESPONSE ( $C_L = 50pF$ )**

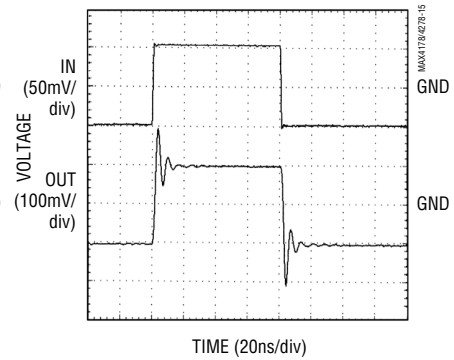

**MAX4278  
LARGE-SIGNAL  
PULSE RESPONSE ( $C_L = 50pF$ )**

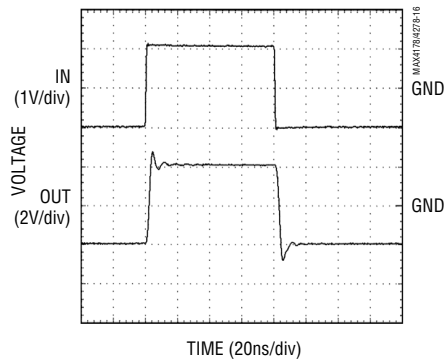

**MAX4278  
SMALL-SIGNAL  
PULSE RESPONSE ( $C_L = 100pF$ )**

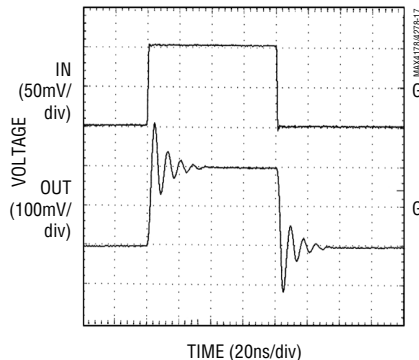

**MAX4278  
LARGE-SIGNAL  
PULSE RESPONSE ( $C_L = 100pF$ )**

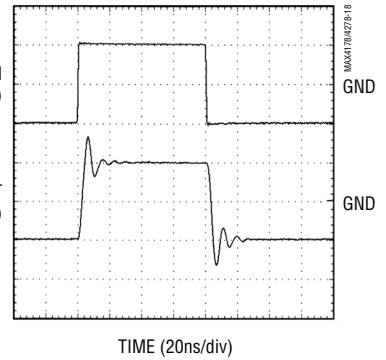

# 330MHz, Gain of +1/Gain of +2 Closed-Loop Buffers

## Typical Operating Characteristics (continued)

( $V_{CC} = +5V$ ,  $V_{EE} = -5V$ ,  $R_L = 100\Omega$ ,  $C_L = 0pF$ ,  $T_A = +25^\circ C$ , unless otherwise noted.)

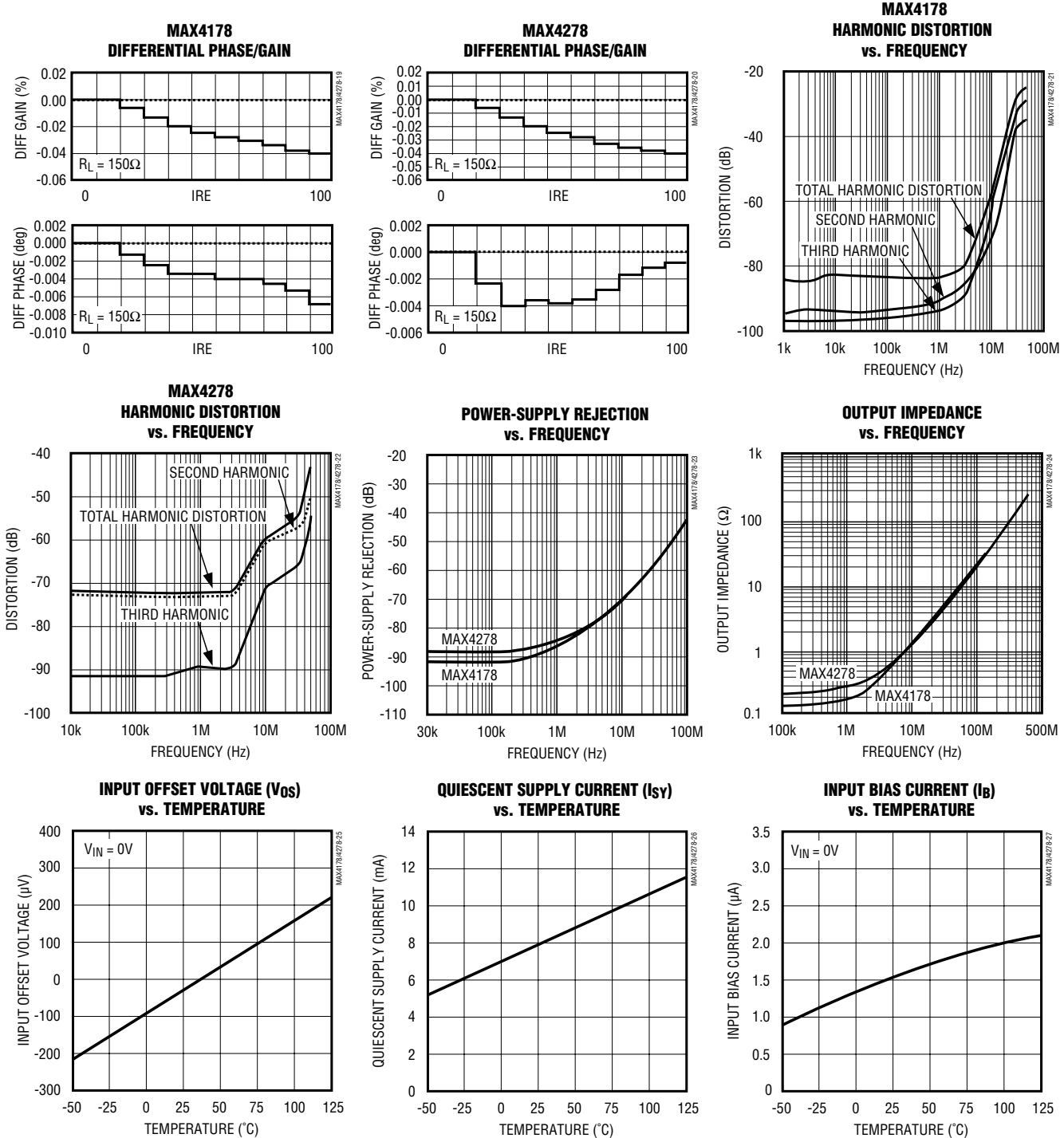

# 330MHz, Gain of +1/Gain of +2 Closed-Loop Buffers

MAX4178/MAX4278

## Typical Operating Characteristics (continued)

( $V_{CC} = +5V$ ,  $V_{EE} = -5V$ ,  $R_L = 100\Omega$ ,  $C_L = 0pF$ ,  $T_A = +25^\circ C$ , unless otherwise noted.)

**OUTPUT VOLTAGE SWING  
vs. TEMPERATURE**

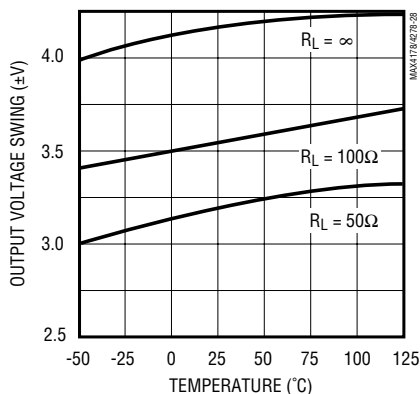

**INPUT VOLTAGE RANGE  
vs. TEMPERATURE**

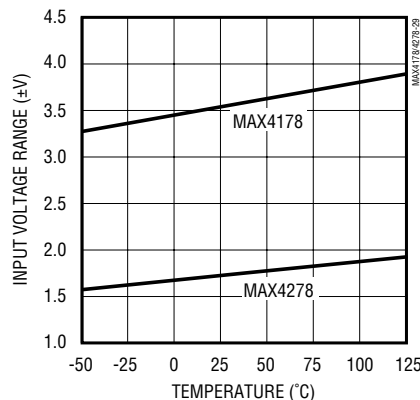

## Pin Description

PIN		NAME	FUNCTION
SO/ $\mu$ MAX/DIP	SOT23		
1, 5, 8	—	N.C.	No Connection
2	4	GND	Ground
3	3	IN	Input
4	2	$V_{EE}$	Negative Power Supply. Connect to -5V.
6	1	OUT	Output
7	5	$V_{CC}$	Positive Power Supply. Connect to +5V.

## Detailed Description

The MAX4178/MAX4278 are  $\pm 5V$ , wide-bandwidth, fast-settling, closed-loop buffers featuring high slew rate, high precision, high output current, low noise, and low differential gain and phase errors. The MAX4178, with a -3dB bandwidth of 330MHz, is preset for unity voltage gain (0dB). The MAX4278 is preset for a voltage gain of +2 (6dB) and has a 310MHz -3dB bandwidth.

These devices have a unique input stage that combines the benefits of a current-mode-feedback topology (high slew rate and low power) with those of a traditional voltage-feedback topology. This combination of architectures results in low input offset voltage and bias current, and high gain precision and power-supply rejection.

Under short-circuit conditions, the output current is typically limited to 150mA. This is low enough that a short to ground of any duration will not cause permanent damage to the chip. However, a short to either supply will create double the allowable power dissipation and may cause permanent damage if allowed to exist for longer than approximately 10 seconds. The high output-current capability is an advantage in systems that transmit a signal to several loads. See the *High-Performance Video Distribution Amplifier* section.

# 330MHz, Gain of +1/Gain of +2 Closed-Loop Buffers

## Applications Information

### Grounding, Bypassing, and PC Board Layout

In order to obtain the MAX4178/MAX4278s' full 330MHz/310MHz bandwidths, microstrip and stripline techniques are recommended in most cases. To ensure that the PC board does not degrade the amplifier's performance, it's a good idea to design the board for a frequency greater than 1GHz. Even with very short traces, it's good practice to use these techniques at critical points, such as inputs and outputs. Whether you use a constant-impedance board or not, observe the following guidelines when designing the board:

- Do not use wire-wrap boards. They are too inductive.
- Do not use IC sockets. They increase parasitic capacitance and inductance.
- In general, surface-mount components have shorter leads and lower parasitic reactance, giving better high-frequency performance than through-hole components.
- The PC board should have at least two layers, with one side a signal layer and the other a ground plane.
- Keep signal lines as short and straight as possible. Do not make 90° turns; round all corners.
- The ground plane should be as free from voids as possible.

On Maxim's evaluation kit, the ground plane has been removed from areas where keeping the trace capacitance to a minimum is more important than maintaining ground continuity.

### Driving Capacitive Loads

The MAX4178/MAX4278 provide maximum AC performance with no output load capacitance. This is the case when the MAX4178/MAX4278 are driving a correctly terminated transmission line (e.g., a back-terminated 75Ω cable). However, the MAX4178/MAX4278 are capable of driving capacitive loads up to 100pF without oscillations, but with reduced AC performance.

Driving large capacitive loads increases the chance of oscillations in most amplifier circuits. This is especially true for circuits with high loop gains, such as voltage followers. The amplifier's output resistance and the load

capacitor combine to add a pole and excess phase to the loop response. If the frequency of this pole is low enough and if phase margin is degraded sufficiently, oscillations may occur.

A second problem when driving capacitive loads results from the amplifier's output impedance, which looks inductive at high frequency. This inductance forms an L-C resonant circuit with the capacitive load, which causes peaking in the frequency response and degrades the amplifier's gain margin.

The MAX4178/MAX4278 drive capacitive loads up to 100pF without oscillation. However, some peaking (in the frequency domain) or ringing (in the time domain) may occur. This is shown in Figures 2a and 2b and the in the Small- and Large-Signal Pulse Response graphs in the *Typical Operating Characteristics*.

To drive larger-capacitance loads or to reduce ringing, add an isolation resistor between the amplifier's output and the load, as shown in Figure 1.

The value of  $R_{ISO}$  depends on the circuit's gain and the capacitive load. Figures 3a and 3b show the Bode plots that result when a 20Ω isolation resistor is used with a voltage follower driving a range of capacitive loads. At the higher capacitor values, the bandwidth is dominated by the RC network, formed by  $R_{ISO}$  and  $C_L$ ; the bandwidth of the amplifier itself is much higher. Note that adding an isolation resistor degrades gain accuracy. The load and isolation resistor form a divider that decreases the voltage delivered to the load.

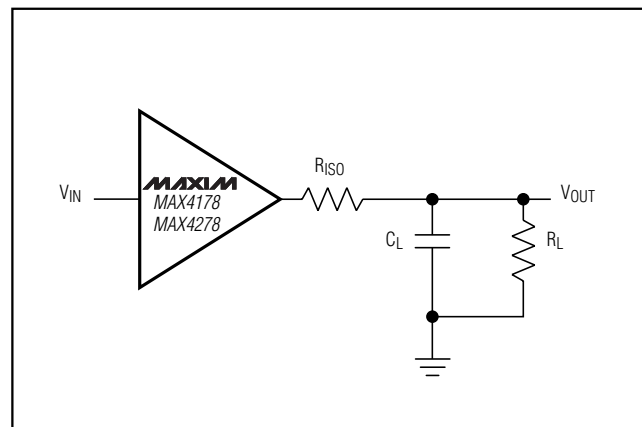

Figure 1. Capacitive-Load Driving Circuit



# 330MHz, Gain of +1/Gain of +2 Closed-Loop Buffers

**MAX4178/MAX4278**

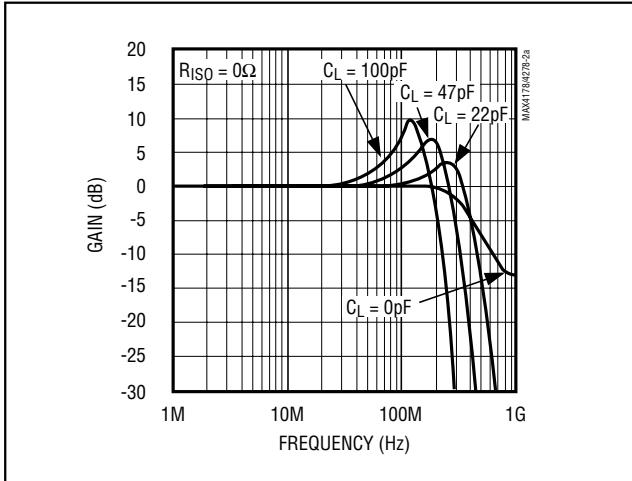

Figure 2a. MAX4178 Small-Signal Gain vs. Frequency with Capacitive Load

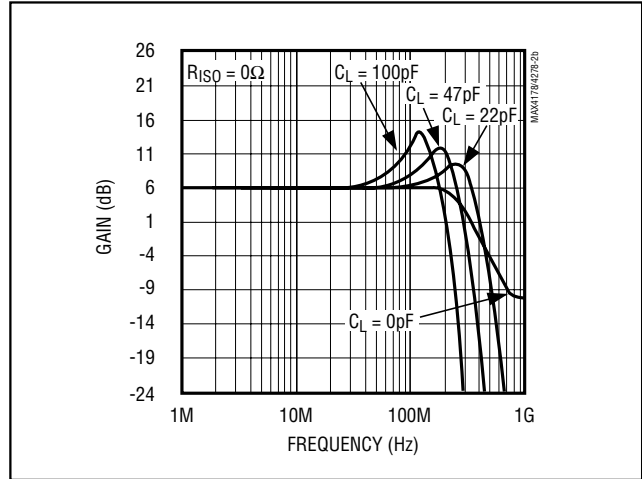

Figure 2b. MAX4278 Small-Signal Gain vs. Frequency with Capacitive Load

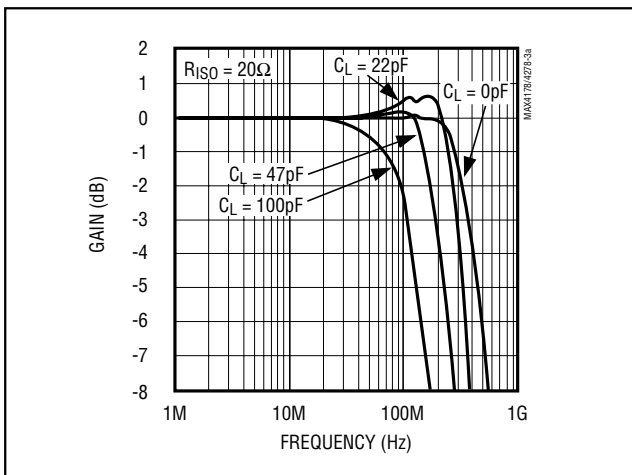

Figure 3a. MAX4178 Small-Signal Gain vs. Frequency with Capacitive Load and Isolation Resistor ( $R_{ISO}$ )

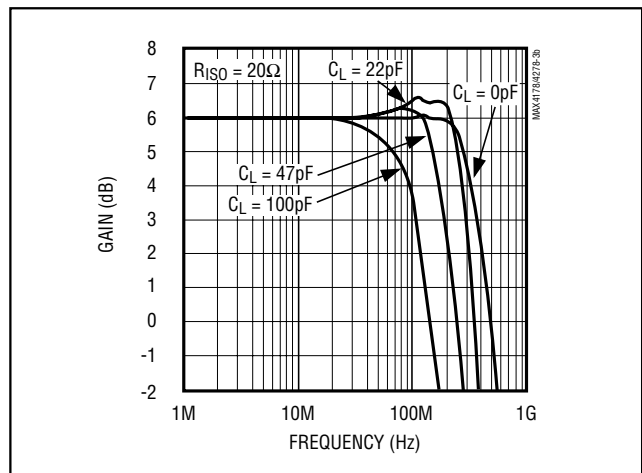

Figure 3b. MAX4278 Small-Signal Gain vs. Frequency with Capacitive Load and Isolation Resistor ( $R_{ISO}$ )

# 330MHz, Gain of +1/Gain of +2 Closed-Loop Buffers

## Flash ADC Preamp

The MAX4178/MAX4278s' high current-drive capability makes them well suited for buffering the low-impedance input of a high-speed flash ADC. With their low output impedance, these buffers can drive the inputs of the ADC with no loss of accuracy. Figure 4 shows a preamp for digitizing video, using the 250Mps MAX100 and the 500Mps MAX101 flash ADCs. Both of these ADCs have a 50Ω input resistance and a 1.2GHz input bandwidth.

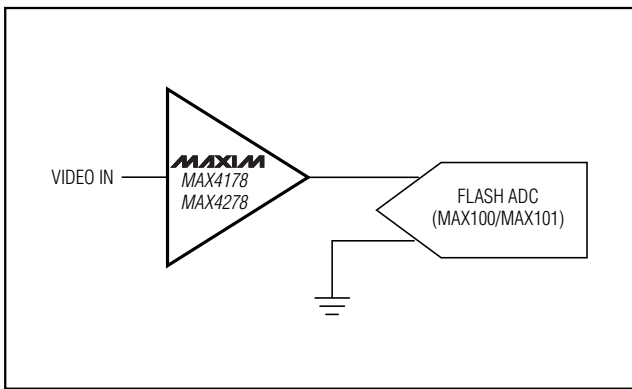

Figure 4. Preamp for Video Digitizer

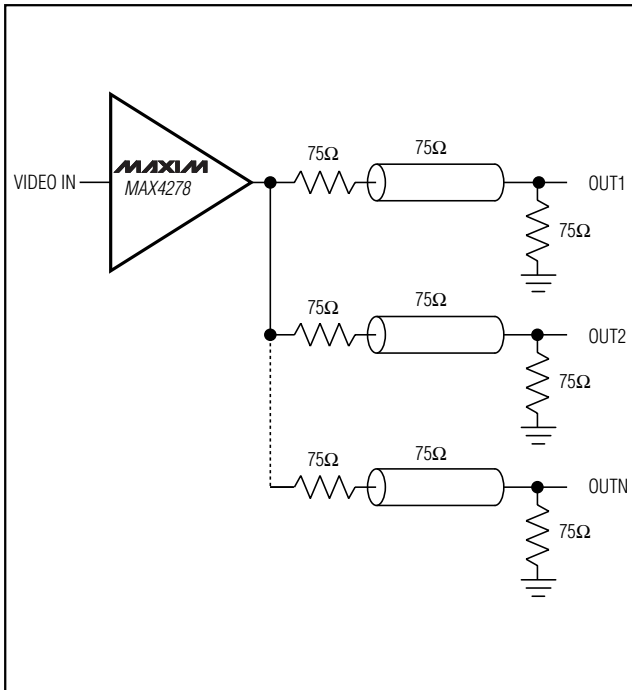

Figure 5. High-Performance Video Distribution Amplifier

## High-Performance Video Distribution Amplifier

The MAX4278 ( $A_V = +2$ ) makes an excellent driver for multiple back-terminated 75Ω video coaxial cables (Figure 5). The high current-output capability allows the attachment of up to six  $\pm 2V_{p-p}$ , 150Ω loads to the MAX4278 at +25°C. With the output limited to  $\pm 1V_{p-p}$ , the number of loads may double. For multiple gain-of-2 video line drivers in a single package, refer to the MAX496/MAX497 data sheet.

## Ordering Information (continued)

PART	TEMP. RANGE	PIN-PACKAGE	SOT TOP MARK
MAX4278EPA	-40°C to +85°C	8 Plastic DIP	—
MAX4278ESA	-40°C to +85°C	8 SO	—
MAX4278EUA	-40°C to +85°C	8 μMAX	—
MAX4278EUK-T	-40°C to +85°C	5 SOT23-5	ABYY
MAX4278MJA	-55°C to +125°C	8 CERDIP	—

## Chip Information

TRANSISTOR COUNT: 175

SUBSTRATE CONNECTED TO V<sub>EE</sub>

# 330MHz, Gain of +1/Gain of +2 Closed-Loop Buffers

## Package Information

(The package drawing(s) in this data sheet may not reflect the most current specifications. For the latest package outline information go to [www.maxim-ic.com/packages](http://www.maxim-ic.com/packages).)

MAX4178/MAX4278

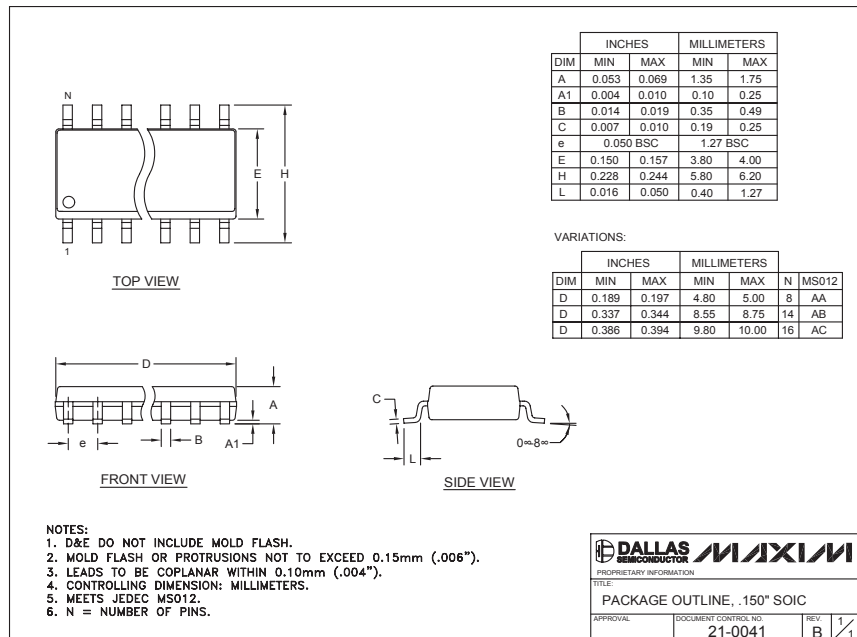
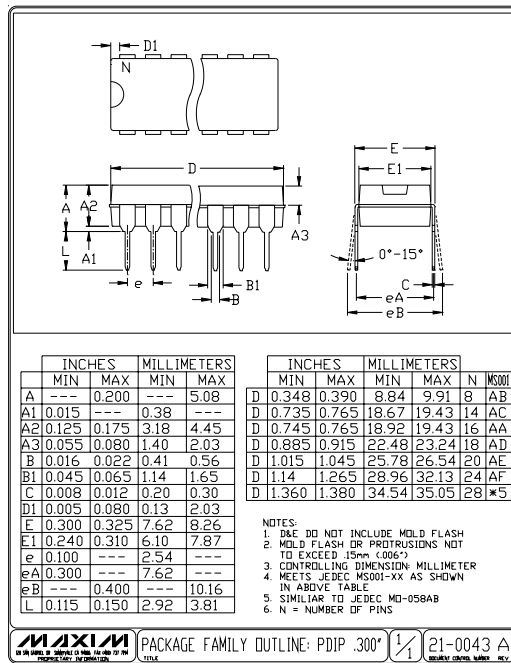

# 330MHz, Gain of +1/Gain of +2 Closed-Loop Buffers

## Package Information (continued)

(The package drawing(s) in this data sheet may not reflect the most current specifications. For the latest package outline information go to [www.maxim-ic.com/packages](http://www.maxim-ic.com/packages).)

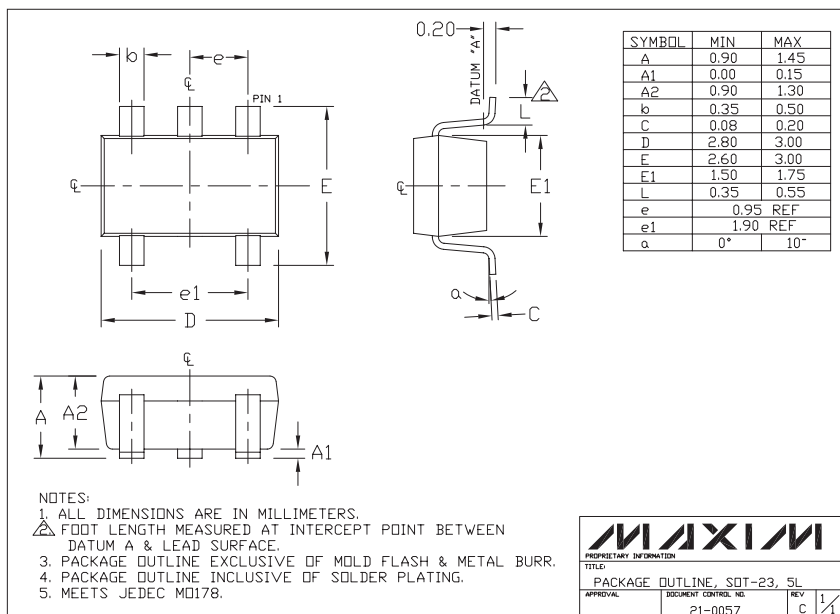
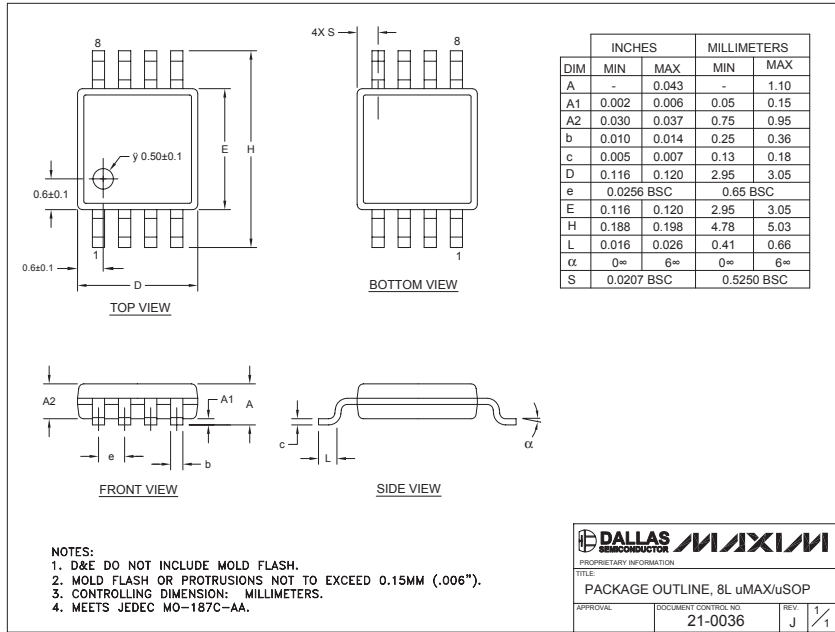

Maxim cannot assume responsibility for use of any circuitry other than circuitry entirely embodied in a Maxim product. No circuit patent licenses are implied. Maxim reserves the right to change the circuitry and specifications without notice at any time.

12 **Maxim Integrated Products, 120 San Gabriel Drive, Sunnyvale, CA 94086 408-737-7600**