

## PowerPlus DC



- Optically Isolated MOSFET output
- Ratings from 10A to 40A @ 150 VDC and 10 & 20A @ 300 VDC
- AC and DC control
- Relays are easily paralleled for higher-current applications
- LED Status Indicator
- Optional IP20 Cover
- UL Recognized, CE and RoHS Compliant
- PWM to 1K HZ

### PRODUCT SELECTION

Control Voltage	10A	20A	40A	60A	10A	20A
4-32 VDC	DC200D10	DC200D20	DC200D40	DC200D60	DC400D10	DC400D20
90-140 VAC	DC200A10	DC200A20			DC400A10	

### AVAILABLE OPTIONS

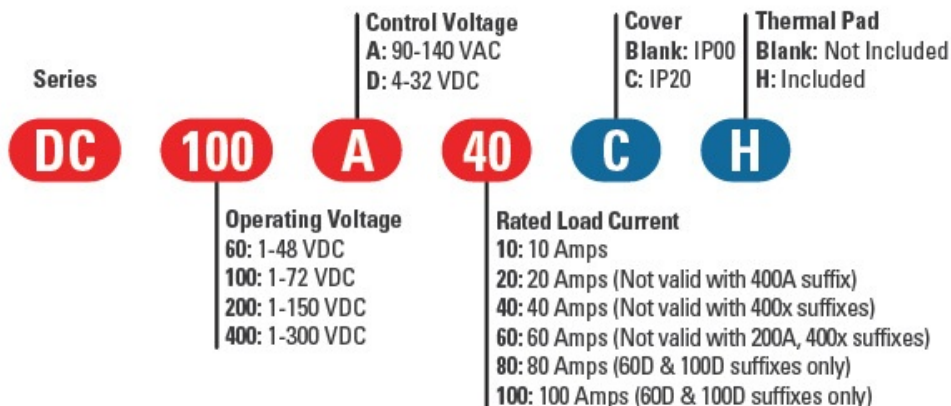

- Required for valid part number
- For options only and not required for valid part number

### OUTPUT SPECIFICATIONS (1)

Description	10A	20A	40A	60A	10A	20A
Operating Voltage [Vdc] (2)	1-150 VDC	1-150 VDC	1-150 VDC	1-150 VDC	1-300 VDC	1-300 VDC
Blocking Voltage	200	200	200	200	400	400
Rated Load Current [Adc] (3)	10	20	40	60	10	20
Minimum Load Current [mA] (4)	2.5	2.5	2.5	2.5	2.5	2.5
Maximum Surge Current [Adc] (10ms)	71	71	142	213	32	48
Maximum On-State Voltage Drop @ Rated Current [Vdc]	0.66	1.1	1	1.1	2.3	3
Maximum Off-State Leakage Current @ Rated Voltage [mA]	0.2	0.2	0.2	0.2	0.4	0.4
Thermal Resistance Junction to Case (Rjc) [°C/W]	1.05	0.85	0.51	0.42	0.57	0.45
Maximum On-State Resistance @ Rated Current [RDS-ON][mOhms]	66	51	24	17	230	155
Maximum PWM [Hz] (5)	1K	1K	900	700	900	700

## INPUT SPECIFICATIONS (1)

Description	DCxxxDxx	DCxxxAxx
Control Voltage Range	4-32 VDC	90-140 VAC
Minimum Input Current @ min Control Voltage [mA]	11	11
Maximum Input Current @ max Control Voltage [mA]	12	13
Nominal Input Impedance	Current Regulated	Current Regulated
Maximum Turn-On Time [msec]	0.075	10
Maximum Turn-Off Time [msec]	0.32	10

## GENERAL SPECIFICATIONS

Description	Parameters
Dielectric Strength, Input/Output/Base (50/60Hz)	2500 Vrms
Minimum Insulation Resistance (@ 500 V DC)	10 <sup>9</sup> Ohm
Maximum Capacitance, Input/Output	10 pF
Ambient Operating Temperature Range (6)	-30 to 80°C
Ambient Storage Temperature Range	-40 to 125 °C
Housing Material	Valox 420 SEO Black, UL 94 V-0
Weight (typical) (7)	2.65 oz (75g)
Encapsulation (8)	Thermally conductive Epoxy
Terminal Finish	Electroless Nickel
Recommended Terminal Screw Torque (6-32) [in lbs/Nm]	10/1.1
Recommended Terminal Screw Torque (8-32) [in lbs/Nm]	20/2.2

## GENERAL NOTES

- 1) All parameters at 40°C and per section unless otherwise specified.
- 2) Maximum voltage is 200 and 400VDC
- 3) Heat sinking required, see derating curves.
- 4) Low current loads and high ambient temperature can affect turn-on time.
- 5) @ a minimum of 8VDC control. See PWM Derating Information page 3.
- 6) Maximum Ambient Operating Temperature for the AC control relays is 65°C.
- 7) Typical weight for the AC control relays is 2.99 oz/85g.
- 8) AC controlled relays contain thermal conductive epoxy.

## MECHANICAL SPECIFICATIONS

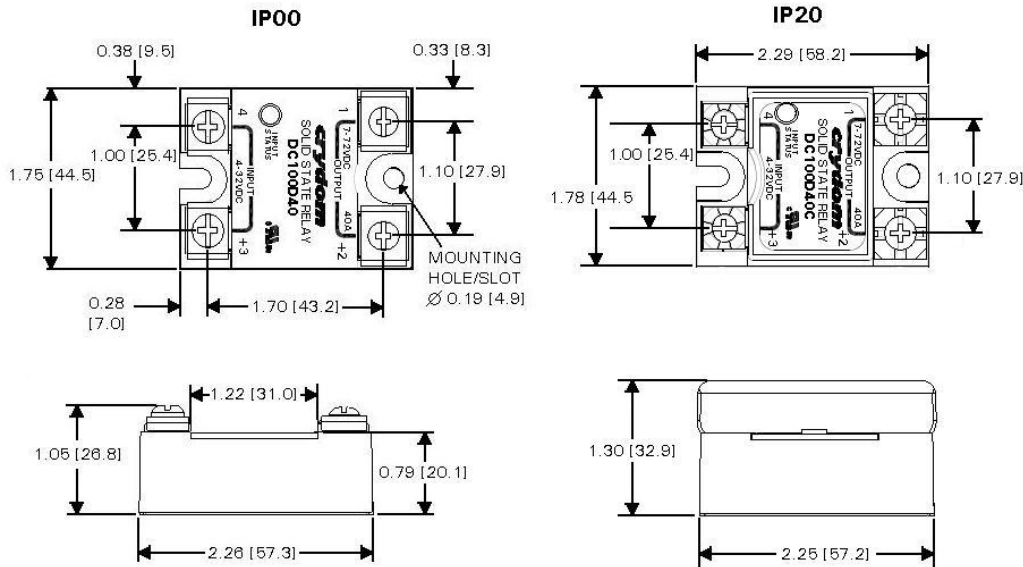

Tolerances: ±0.02 in / 0.5 mm  
 All dimensions are in: inches [millimeters]

## WIRING DIAGRAM

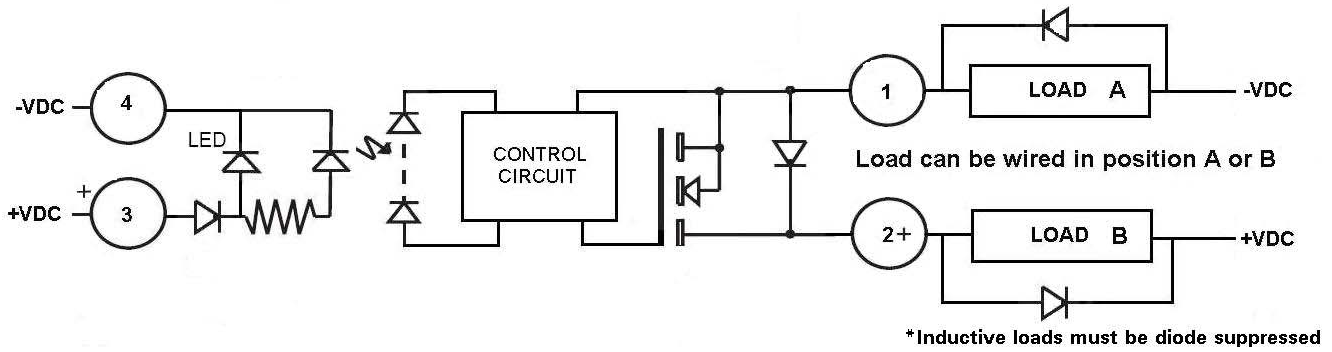

## PWM DERATE INFORMATION

PWM frequency vs. Load Current DC200DXX

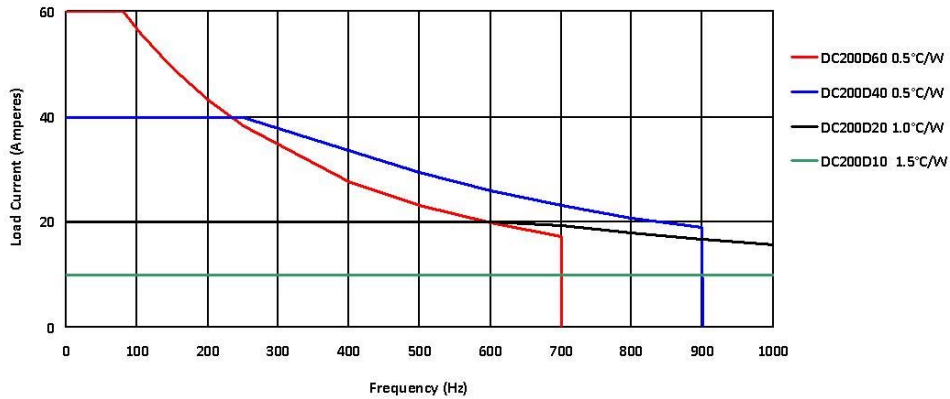

PWM frequency vs Load Current DC400DXX

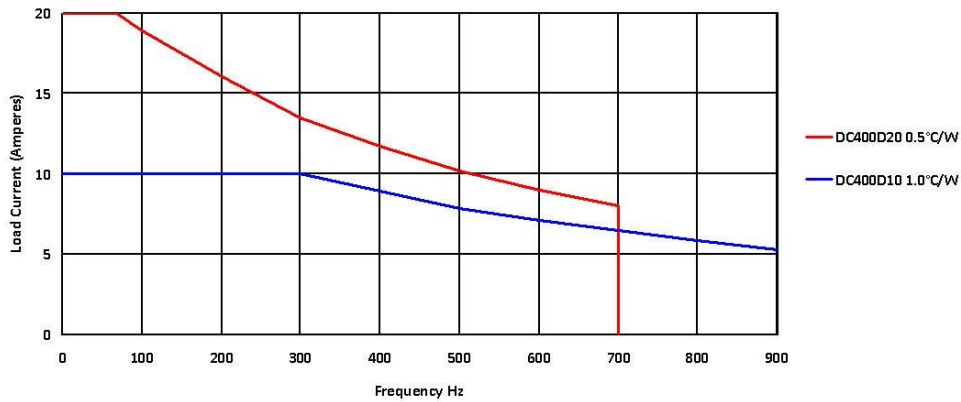

**THERMAL DERATE INFORMATION**

**Derating Curve: DC200D60**

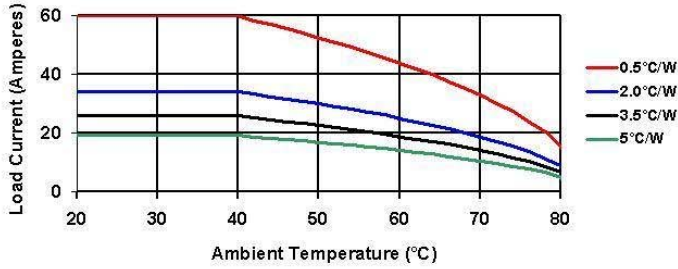

**Derating Curve: DC200D40**

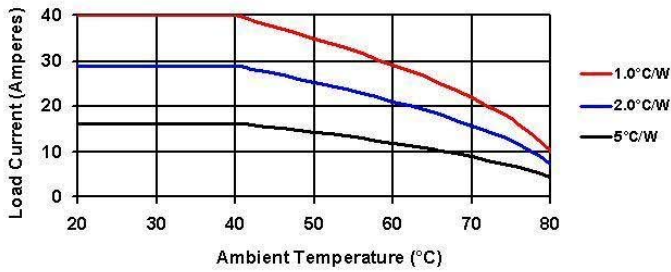

**Derating Curve: DC200A40**

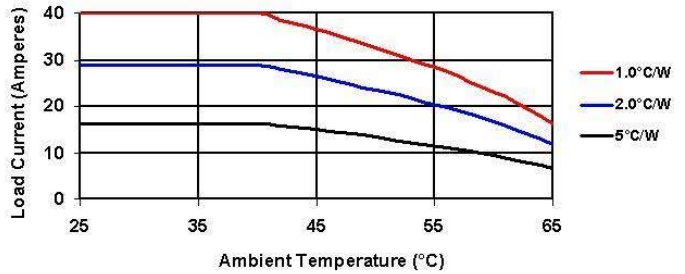

**Derating Curve: DC200D20**

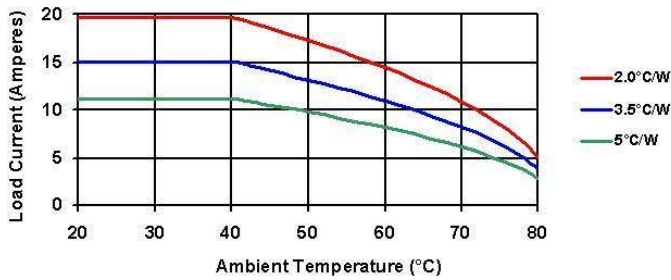

**Derating Curve: DC200A20**

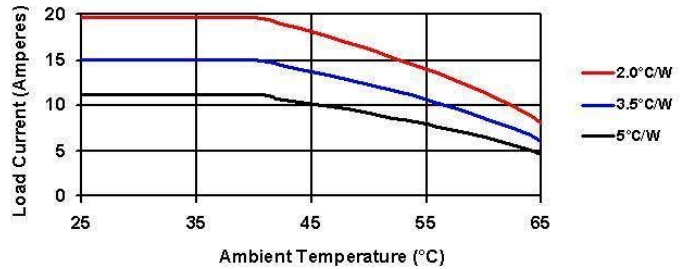

**Derating Curve: DC200D10**

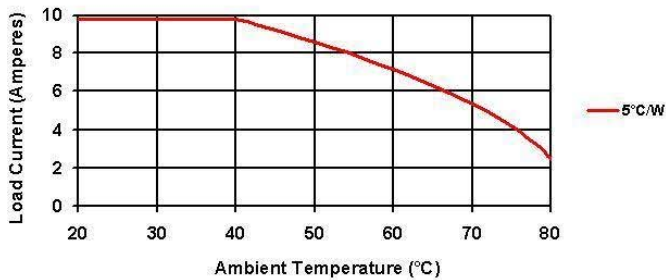

**Derating Curve: DC200A10**

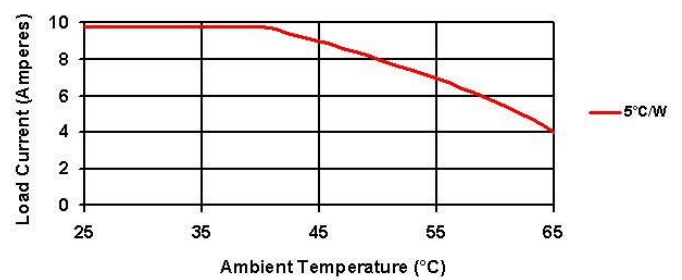

**THERMAL DERATE INFORMATION**

**Derating Curve: DC400D20**

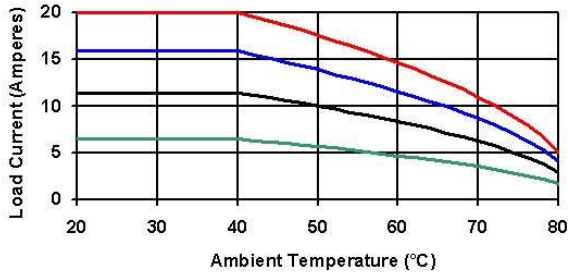

**Derating Curve: DC400A20**

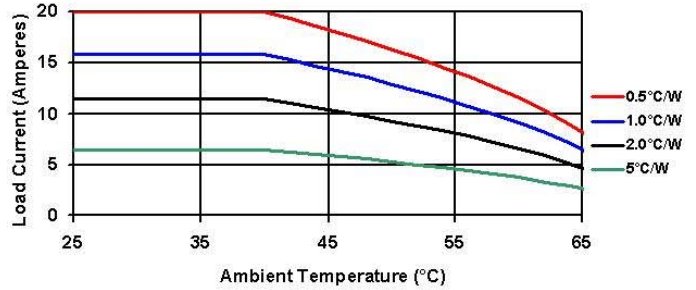

**Derating Curve: DC400D10**

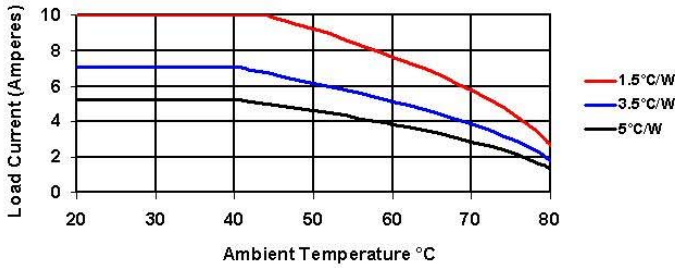

**Derating Curve: DC400A10**

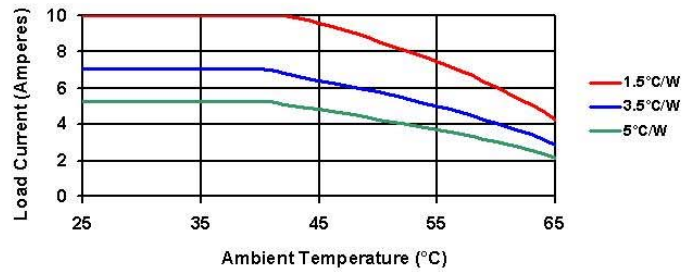



**AGENCY APPROVALS**

Designed in accordance with the requirements of IEC 62314  
 IEC 61000-4-2 Electrostatic Discharge Level 3, Criteria A  
 IEC 61000-4-4 Electrically Fast Transients Level 3, Criteria A  
 IEC 61000-4-5 Electrical Surges Level 3, Criteria A



072312

 <b>DANGER / PELIGRO / DANGER /GEFAHR / PERICOLO / PERIGO</b>					
<p><b>HAZARD OF ELECTRIC SHOCK, EXPLOSION, OR ARC FLASH.</b></p> <ul style="list-style-type: none"> <li>• Disconnect all power before installing or working with this equipment.</li> <li>• Verify all connections and replace all covers before turning on power.</li> </ul> <p><b>Failure to follow these instructions will result in death or serious injury.</b></p>	<p><b>RIESGO DE DESCARGA ELECTRICA O EXPLOSION.</b></p> <ul style="list-style-type: none"> <li>• Desconectar todos los suministros de energia a este equipo antes de trabajar con este equipo.</li> <li>• Verificar todas las conexiones y colocar todas las tapas antes de energizar el equipo.</li> </ul> <p><b>El incumplimiento de estas instrucciones puede provocar la muerte o lesiones serias.</b></p>	<p><b>RISQUE DE DESCARGE ELECTRIQUE OU EXPLOSION</b></p> <ul style="list-style-type: none"> <li>• Eteindre toutes les sources d'énergie de cet appareil avant de travailler dessus de cet appareil</li> <li>• Vérifier tous connections, et remettre tous couverts en olace avant de mettre sous</li> </ul> <p><b>De non-suivi de ces instructions provoquera la mort ou des lésions sérieuses sérieuses.</b></p>	<p><b>GEFAHR EINES ELEKTRISCHE N SCHLAGES ODER EINER EXPLOSION.</b></p> <ul style="list-style-type: none"> <li>• Stellen Sie jeglichen Strom ab, der dieses Gerät versorgt, bevor Sie an dem Gerät Arbeiten durchführen</li> <li>• Vor der Inbetriebnahme alle Anschlüsse überprüfen und alle Gehäuseteile montieren.</li> </ul> <p><b>Unterlassung dieser Anweisungen können zum Tode oder zu schweren Verletzungen führen.</b></p>	<p><b>RISCHIO DI SCOSSA ELETTRICA O DELL'ESPLOSIONE.</b></p> <ul style="list-style-type: none"> <li>• Spenga tutta l'alimentazion e che fornisce questa apparecchiatura prima del lavorare a questa apparecchiatura</li> <li>• Verificare tutti i collegamenti e sostituire tutte le coperture prima della rotazione sull'alimentazione</li> </ul> <p><b>L'omissione di seguire queste istruzioni provocherà la morte o di lesioni serie</b></p>	<p><b>RISCO DE DESCARGA ELÉTRICA OU EXPLOÇÃO</b></p> <ul style="list-style-type: none"> <li>• Desconectar o equipamento de toda a energia antes de instalar ou trabalhar com este equipamento</li> <li>• Verificar todas as conexões e recolocar todas as tampas antes de religar o equipamento</li> </ul> <p><b>O não cumprimento destas instruções pode levar à morte ou lesões sérias.</b></p>

 <b>WARNING / AVERTISSEMENT / WARNUNG /ADVERTENCIA / AVVERTENZA / AVISO</b>		
<p><b>RISK OF MATERIAL DAMAGE AND HOT ENCLOSURE</b></p> <ul style="list-style-type: none"> <li>• The product's side panels may be hot, allow the product to cool before touching.</li> <li>• Follow proper mounting instructions including torque values.</li> <li>• Do not allow liquids or foreign objects to enter this product.</li> </ul> <p><b>Failure to follow these instructions can result in serious injury, or equipment damage.</b></p>	<p><b>RISQUE DE DOMMAGE MATERIEL ET DE SURCHAUFFE DU BOITIER</b></p> <ul style="list-style-type: none"> <li>• Les panneaux latéraux du produit peuvent être chauds. Laissez le produit refroidir avant de le toucher.</li> <li>• Respecter les consignes de montage, et notamment les couples de serrage.</li> <li>• Ne pas laisser pénétrer de liquide ni de corps étrangers à l'intérieur du produit.</li> </ul> <p><b>Le non-respect de cette directive peut entraîner, des lésions corporelles graves ou des dommages matériels.</b></p>	<p><b>GEFAHR VON MATERIALSCHÄDEN UND GEHÄUSEERHITZUNG</b></p> <ul style="list-style-type: none"> <li>• Die Seitenwände können heiß sein. Lassen Sie das Produkt abkühlen, bevor Sie es berühren.</li> <li>• Beachten Sie die Montageanweisungen,</li> <li>• Führen Sie keine Flüssigkeiten oder Fremdkörper in das Produkt ein.</li> </ul> <p><b>Die Nichtbeachtung dieser Anweisung kann Körperverletzung oder Materialschäden zur Folge haben.</b></p>
<p><b>RIESGO DE DAÑOS MATERIALES Y DE SOBRECIENTAMIENTO DE LA UNIDAD</b></p> <ul style="list-style-type: none"> <li>• Los paneles laterales del producto pueden estar calientes. Esperar que el producto se enfríe antes de tocarlo.</li> <li>• Respetar las instrucciones de montaje, y en particular los pares de apretado.</li> <li>• No dejar que penetren líquidos o cuerpos extraños en el producto.</li> </ul> <p><b>Si no se respetan estas precauciones pueden producirse graves lesiones, daños materiales.</b></p>	<p><b>RISCHIO DI DANNI MATERIALI E D'INVOLUCRO CALDO</b></p> <ul style="list-style-type: none"> <li>• I pannelli laterali dell'apparecchio possono scottare; lasciar quindi raffreddare il prodotto prima di toccarlo.</li> <li>• Seguire le istruzioni di montaggio corrette.</li> <li>• Non far entrare liquidi o oggetti estranei in questo apparecchio.</li> </ul> <p><b>La mancata osservanza di questa precauzione può causare gravi rischi per l'incolumità personale o danni alle apparecchiature.</b></p>	<p><b>RISCO DE DANO MATERIAL E DE AQUECIMENTO</b></p> <ul style="list-style-type: none"> <li>• Os painéis laterais do produto podem estar quentes; dê tempo ao produto para arrefecer antes de lhe tocar.</li> <li>• Siga devidamente as instruções de montagem.</li> <li>• Não permita a entrada de líquidos e de objectos estranhos no produto.</li> </ul> <p><b>A não observância destas precauções pode provocar a morte, ferimentos graves ou danos materiais.</b></p>

**ANNEX - ENVIROMENTAL INFORMATION**

The environmental information disclosed in this annex including the EIP Pollution logo are in compliance with People's Republic of China Electronic Industry Standard SJ/T11364 – 2006, Marking for Control of Pollution Caused by Electronic Information Products.

Part Name	Toxic or hazardous Substance and Elements					
	Lead (Pb)	Mercury (Hg)	Cadmium (Cd)	Hexavalent Chromium (Cr (VI))	Polybrominated biphenyls (PBB)	Polybrominated diphenyl ethers (PBDE)
Semiconductor die	X	○	○	○	○	○
Solder	X	○	○	○	○	○

此附件所标示的包括电子信息产品污染图标的环保信息符合中华人民共和国电子行业标准 **SJ/T11364 - 2006**, 电子信息产品污染控制标识要求



部件名称	有毒有害物质或元素					
	铅 (Pb)	汞 (Hg)	镉 (Cd)	六价铬 (Cr (VI))	多溴联苯 (PBB)	多溴二苯醚 (PBDE)
半导体芯片	X	○	○	○	○	○
焊接点	X	○	○	○	○	○