

DO NOT SCALE FROM THIS PRINT

TSW-XXX-XX-XXX-X-XX-XXX

TABLE 2	
BODY SPECIFICATION	
ROW/OPTION	USE BODY
-S, -S-NA/-NE	TSW-50-S
-S-RA/-RE	TSW-50-S-RA
-D, -D-NA/-NE	RTSW-50-D
-D-RA	TSW-50-D-RA
-T, -T-NA/-NE	TSW-50-T
-T-RA, -Q-RA	TSW-50-T-RA
-Q	TSW-50-T

**TERMINAL SPACE SPEC.**  
(SEE ASSEMBLY INSTRUCTIONS)  
-1= .100[2.54] FILL EVERY POSITION  
-2= .200[5.08] FILL EVERY OTHER POS.  
STARTING W/ 1ST & ENDING W/ LAST POS. IN BODY)

**BODY LENGTH SPEC.**  
EXPRESSED IN # OF POS  
-1: -01 THRU -50 (-S, -D, -T)  
"A" = NO. OF POS. x .100[2.54]  
-2: -02 THRU -25 (-S, -D, -T)  
"A" = NO OF POS. x .200[5.08] - .100[2.54]

**TERMINAL SPECIFICATION**  
SEE TABLE 1

**PLATING SPECIFICATION**  
-G: 10µ" GOLD IN CONTACT AREA, 3µ" GOLD ON TAIL  
-T: MATTE TIN CONTACT AND TAIL  
-S: 30µ" SELECTIVE GOLD IN CONTACT AREA, MATTE TIN ON TAIL  
-H: 30µ" HEAVY GOLD IN CONTACT AREA, 3µ" GOLD ON TAIL  
-L: 10µ" LIGHT SELECTIVE GOLD IN CONTACT AREA, MATTE TIN ON TAIL  
-F: 3µ" FLASH SELECTIVE GOLD IN CONTACT AREA, MATTE TIN ON TAIL  
-E: 50µ" EXTRA HEAVY GOLD IN CONTACT AREA, 3µ" GOLD ON TAIL  
-TL: TIN/LEAD (90/10 +/-5%) CONTACT AND TAIL  
(AVAILABLE ONLY ON LEAD STYLES -07, -08 & -09)  
-STL: 30µ" SELECTIVE GOLD IN CONTACT AREA, TIN/LEAD (90/10 +/-5%) TAIL  
(AVAILABLE ONLY ON LEAD STYLES -07, -08, -10, -15, -16, -17, -21, -23 & -24 THROUGH HOLE ONLY)  
-TM: MATTE TIN CONTACT AND TAIL  
-SM: 30µ" SELECTIVE GOLD IN CONTACT AREA, MATTE TIN ON TAIL  
-LM: 10µ" LIGHT SELECTIVE GOLD IN CONTACT AREA, MATTE TIN ON TAIL  
-FM: 3µ" FLASH SELECTIVE GOLD IN CONTACT AREA, MATTE TIN ON TAIL  
-SS: 30µ" STRIPE SELECTIVE GOLD IN CONTACT AREA, MATTE TIN ON TAIL (SEE NOTE 13)

**OPTION #2**  
-POLARIZING SPECIFICATION  
XXX INDICATES POS. TO BE OMITTED (SEE FIG 3)

**OPTION #1**  
-BLANK= STRAIGHT  
-RA= RIGHT ANGLE (SEE TABLE 3 & 5, FIG 5)  
-RE= EXTENDED RIGHT ANGLE (SEE TABLE 3 & 5, FIG 5)(SINGLE ROW ONLY)  
-NA= RA OPTION WITH STRAIGHT OPTION BODY  
-NE= RE OPTION WITH STRAIGHT OPTION BODY  
-LC= LOCKING CLIP (USE LTC-01 FOR -S ROW AND LTC-02 FOR -D ROW)(STYLES 08 THRU 13 & 22 ONLY) (SEE FIG 2)  
(N/A IN -RA OR -RE OPTION AND/OR LESS THAN 4 POSITIONS)  
(N/A IN -T OR -Q)  
-LA= -RA OPTION WITH -LL OPTION (SEE FIG 5)  
-LL= LOCKING LEAD (SEE FIG 4)  
(N/A WITH -RE OR -NE OPTION)  
(N/A IN SINGLE ROW, 1 OR 2 POSITIONS)

**ROW SPECIFICATION (SEE TABLE 2)**  
-S: SINGLE  
-D: DOUBLE  
-T: TRIPLE  
-Q: TRIPLE ROW, FILL OUTER ROWS ONLY

NOTES:

- ⊕ REPRESENTS CRITICAL DIMENSION.
- MINIMUM TERMINAL PUSHOUT: 3 LBS.
- MAXIMUM HEIGHT VARIATION: .005 [.13] (R.A. TAIL N/A).
- ASSEMBLE GOLD PLATE END AS SHOWN.
- STYLE -26: ROUND END TO APPEAR ON BOTTOM.
- C ± <sup>.005(0.13)</sup>/<sub>.008(0.20)</sub> FOR STYLE -08, OPTION -LA & -RA ONLY.
- TOW & SWAY SPEC. OF 2° APPLIES TO ALL POSITIONS, POST & TAIL, IN ALL DIRECTIONS.
- ALL DIMENSIONS TO BE ABOUT CL WITHIN ±.005 [.13].
- MEASURE FROM THE BEND RADIUS OF THE TERMINALS.
- TSW-50-D BODY CAN BE USED IF RTSW-50-D IS UNAVAILABLE
- ORIENTATE PINS TO PREVENT BANDOLIER MARKS FROM SHOWING IN THE POST AREA. (SEE TABLE 7)
- MAXIMUM CUT FLASH: .020 [.50]
- SS OPTION ONLY AVAILABLE IN STRAIGHT LEAD STYLES -07, -08 & -09, -RA STYLE -08 ONLY. CAN ONLY MATE WITH SSW, SSSQ, SSM, ESW, ESQ AND BCS.

<p>UNLESS OTHERWISE SPECIFIED, DIMENSIONS ARE IN INCHES.</p> <p>TOLERANCES ARE:</p> <table border="0"> <tr> <td>DECIMALS</td> <td>ANGLES</td> </tr> <tr> <td>.XX: ±.01 [.3]</td> <td>2°</td> </tr> <tr> <td>.XXX: ±.005 [.13]</td> <td></td> </tr> <tr> <td>.XXXX: ±.0020 [.051]</td> <td></td> </tr> </table>	DECIMALS	ANGLES	.XX: ±.01 [.3]	2°	.XXX: ±.005 [.13]		.XXXX: ±.0020 [.051]		<p><b>PROPRIETARY NOTE</b></p> <p>THIS DOCUMENT CONTAINS INFORMATION CONFIDENTIAL AND PROPRIETARY TO SAMTEC, INC. AND SHALL NOT BE REPRODUCED OR TRANSFERRED TO OTHER DOCUMENTS OR DISCLOSED TO OTHERS OR USED FOR ANY PURPOSE OTHER THAN THAT WHICH IT WAS OBTAINED WITHOUT THE EXPRESSED WRITTEN CONSENT OF SAMTEC, INC.</p>	 <p>520 PARK EAST BLVD., NEW ALBANY, IN 47150 PHONE: 812-944-6733 FAX: 812-948-5047 e-Mail info@SAMTEC.com code 55322</p>
	DECIMALS	ANGLES								
.XX: ±.01 [.3]	2°									
.XXX: ±.005 [.13]										
.XXXX: ±.0020 [.051]										
<p><b>MATERIAL:</b> DO NOT SCALE DRAWING SHEET SCALE: 3:1</p> <p>BODIES: DUPONT PBT, UL 94 VO, COLOR: BLACK TERMINALS: PHOS BRONZE</p>	<p><b>DESCRIPTION:</b> .025[0.64] SQ. POST TERMINAL STRIP ASSEMBLY</p> <p>DWG. NO. <b>TSW-XXX-XX-XXX-X-XX-XXX</b></p> <p>BY: KOLB 08/24/1988 SHEET 1 OF 6</p>									

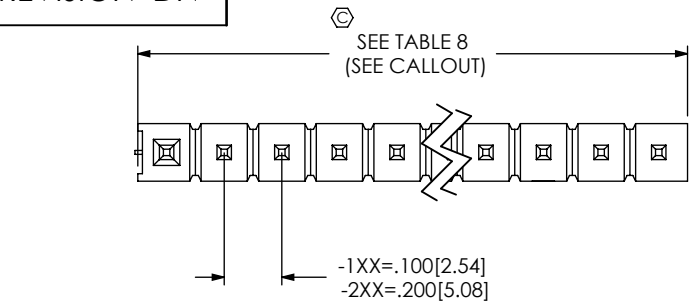

TABLE 8	
ROW SPECIFICATION	OVERALL LENGTH
-Q, -T	"A" +.010/-.015 [+0.25/-0.38]
-S, -D	"A" +.015/-.015 [+0.38/-0.38]

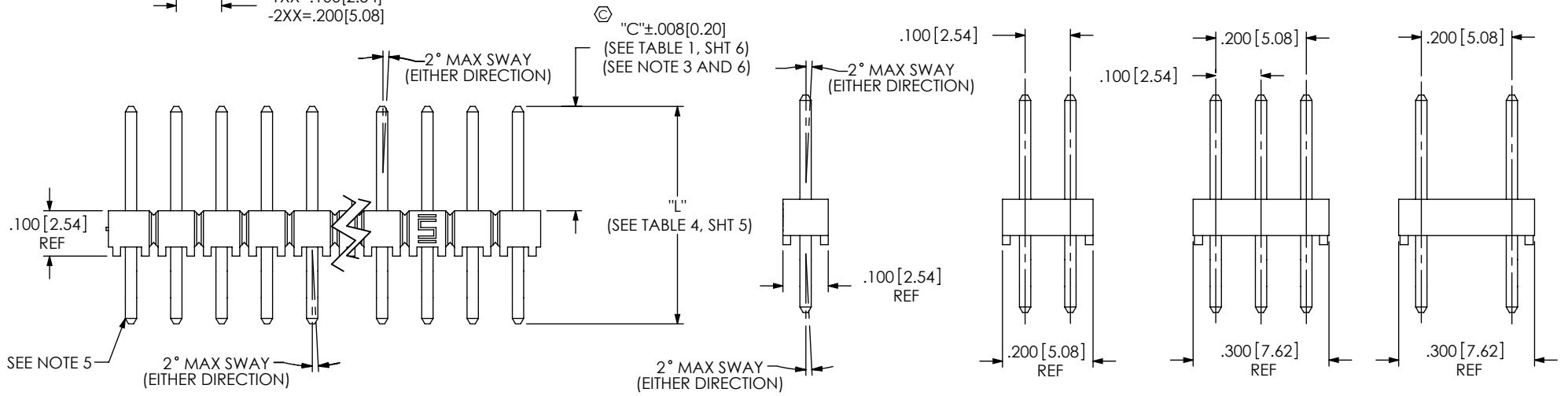

FIG 1  
(TSW-1XX-XX-XX-S SHOWN)

-S

-D

-T

-Q

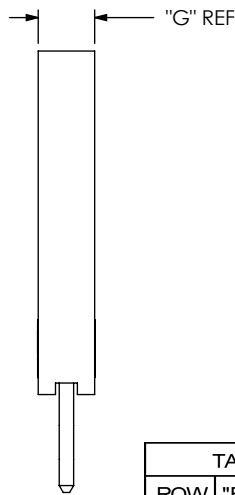
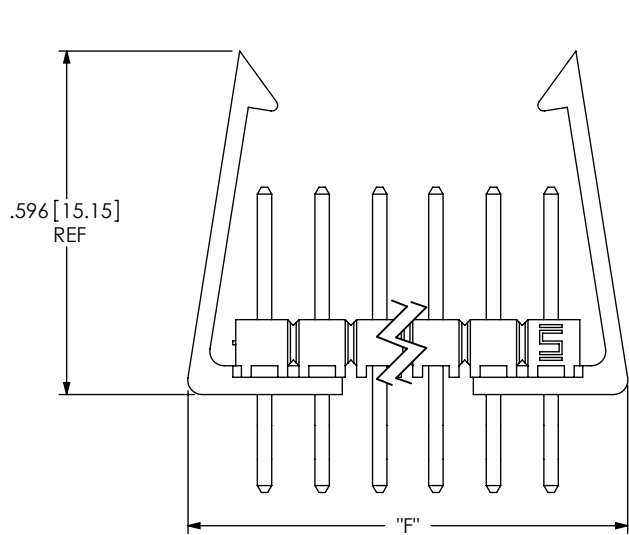

TABLE 6 -LC OPTION		
ROW	"F" ±.015[0.38]	"G"
-S	"A"±.150	.098[2.49]
-D	"A"±.210	.198[5.03]

FIG 2  
(TSW-1XX-XX-XX-S-LC SHOWN)  
(SAME AS FIG 1, DIFFERENT AS SHOWN)

PROPRIETARY NOTE  
THIS DOCUMENT CONTAINS INFORMATION  
CONFIDENTIAL AND PROPRIETARY TO  
SAMTEC, INC. AND SHALL NOT BE REPRODUCED  
OR TRANSFERRED TO OTHER DOCUMENTS OR  
DISCLOSED TO OTHERS OR USED FOR ANY  
PURPOSE OTHER THAN THAT WHICH IT WAS  
OBTAINED WITHOUT THE EXPRESSED WRITTEN  
CONSENT OF SAMTEC, INC.

DO NOT SCALE DRAWING

SHEET SCALE: 3:1

**samtec**

520 PARK EAST BLVD, NEW ALBANY, IN 47150  
PHONE: 812-944-6733 FAX: 812-948-5047  
e-Mail: info@SAMTEC.com code 55322

DESCRIPTION:  
.025[0.64] SQ. POST TERMINAL STRIP ASSEMBLY

DWG. NO.  
TSW-XXX-XX-XXX-X-XX-XXX

BY: KOLB 08/24/1988 SHEET 2 OF 6

FIG 3

-1: .100[2.54] TERMINAL SPACING  
(SAME AS FIG 1, DIFFERENT AS SHOWN)

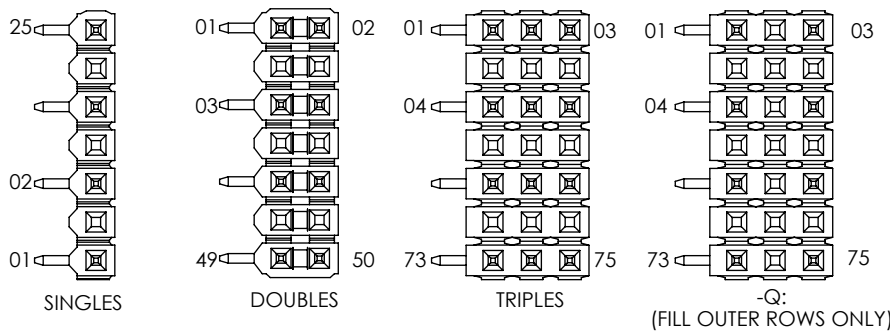
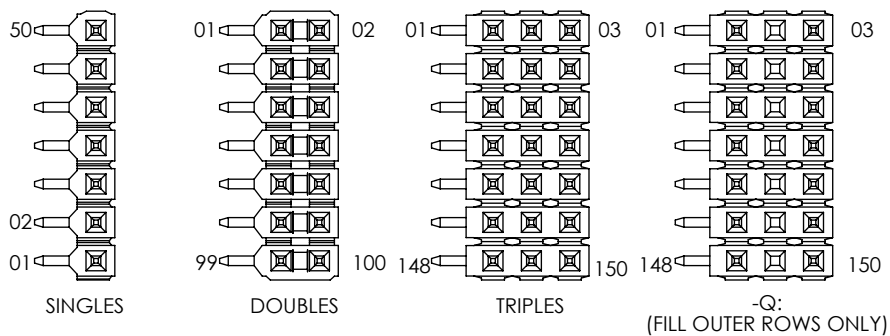

-2: .200[5.08] TERMINAL SPACING

FIG 4  
LOCKING LEAD  
(NOTE: END VIEWS SHOWN)  
(SAME AS FIG 1, DIFFERENT AS SHOWN)

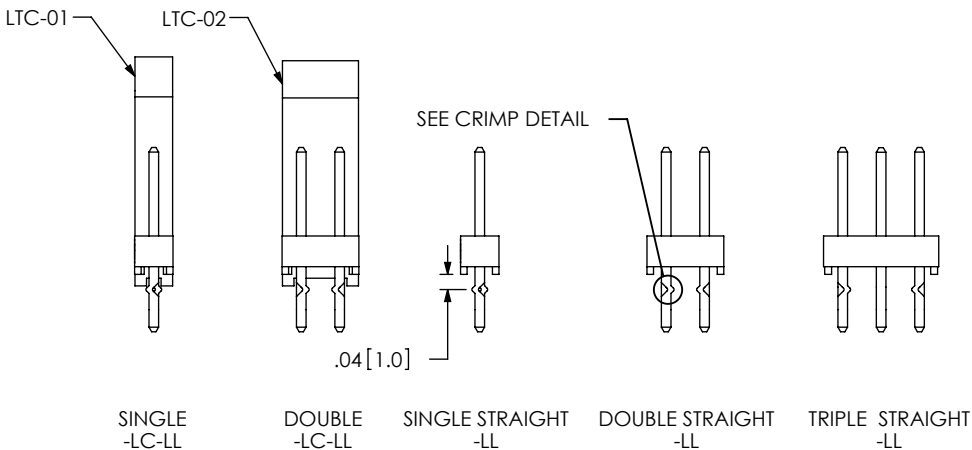

CRIMP DETAIL  
SCALE: 4:1  
(TYP ALL CRIMPS)

F:\DWG\MISC\MKTG\TSW-XXX-XX-XXX-X-XX-XXX-MKT.SLDDRW

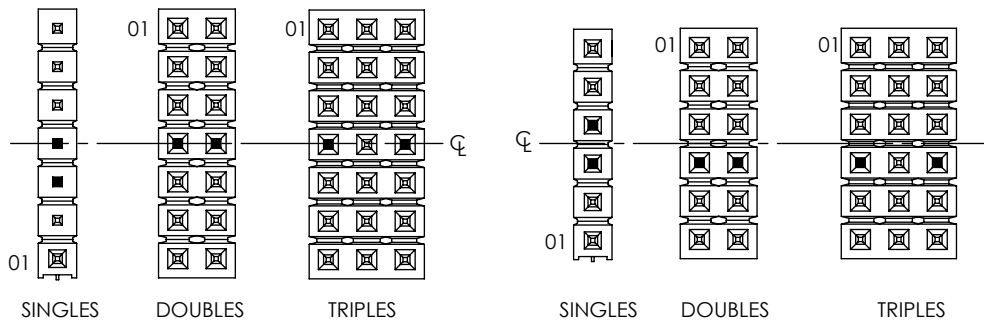

STRAIGHT VERSION  
ODD POSITIONS

STRAIGHT VERSION  
EVEN POSITIONS

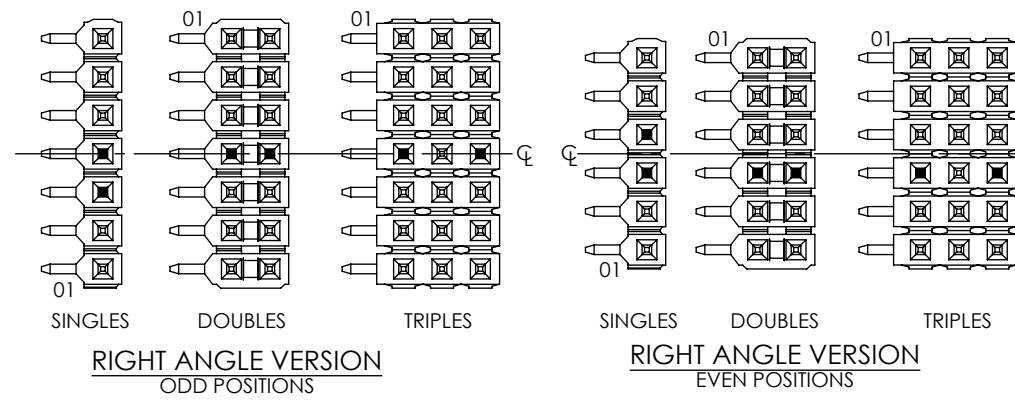

RIGHT ANGLE VERSION  
ODD POSITIONS

RIGHT ANGLE VERSION  
EVEN POSITIONS

LOCKING LEAD

■ = CRIMP LOCATION  
TWO CENTER MOST PINS TO BE CRIMPED.  
ODD POSITIONS, CRIMP CENTER POSITION AND POSITION CLOSEST TO PIN ONE.  
IF CRIMP POSITION IS POLARIZED, MOVE ONE POSITION TOWARDS PIN ONE.

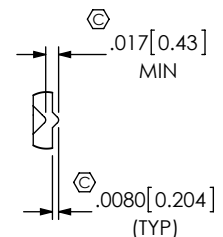

PROPRIETARY NOTE  
THIS DOCUMENT CONTAINS INFORMATION CONFIDENTIAL AND PROPRIETARY TO SAMTEC, INC. AND SHALL NOT BE REPRODUCED OR TRANSFERRED TO OTHER DOCUMENTS OR DISCLOSED TO OTHERS OR USED FOR ANY PURPOSE OTHER THAN THAT WHICH IT WAS OBTAINED WITHOUT THE EXPRESSED WRITTEN CONSENT OF SAMTEC, INC.

DO NOT SCALE DRAWING

SHEET SCALE: 2:1



520 PARK EAST BLVD, NEW ALBANY, IN 47150  
PHONE: 812-944-6733 FAX: 812-948-5047  
e-Mail: info@SAMTEC.com code 55322

DESCRIPTION:  
.025[0.64] SQ. POST TERMINAL STRIP ASSEMBLY

DWG. NO.  
TSW-XXX-XX-XXX-X-XX-XXX

BY: KOLB 08/24/1988 SHEET 3 OF 6

**FIG 5**  
 (RIGHT ANGLE)  
 (-LA OPTION IS SHOWN ON ALL RIGHT ANGLES  
 FOR DIMENSIONAL AND LOCATION PURPOSES.)  
 (SEE CRIMP DETAIL VIEW, SHT 3)  
 (SAME AS FIG 1, DIFFERENT AS SHOWN)

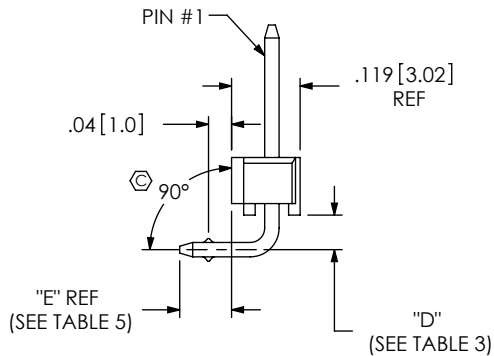

-S

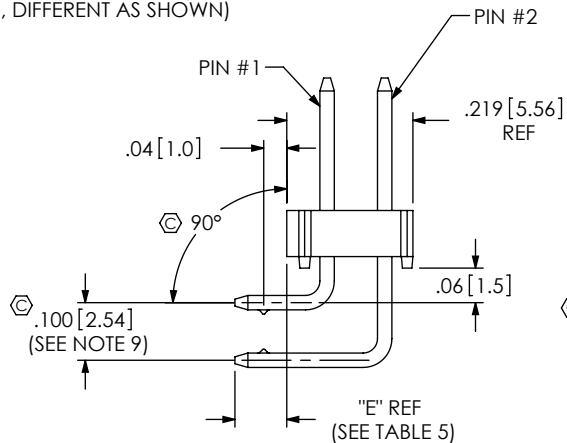

-D

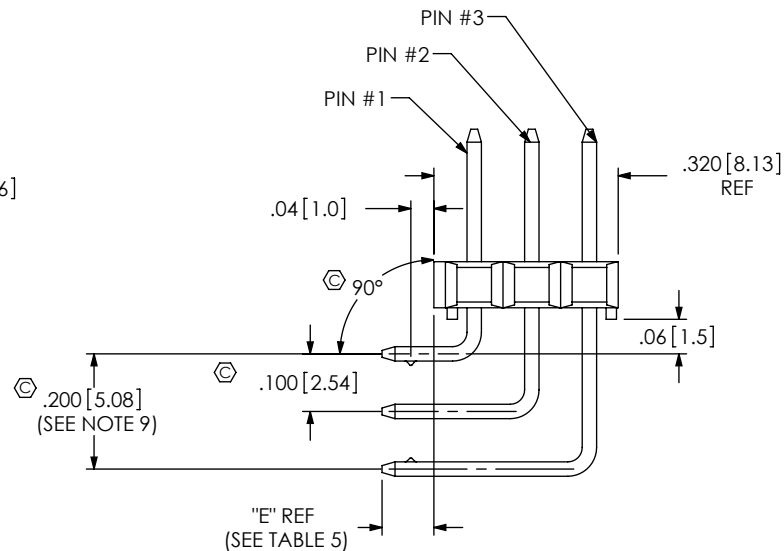

-T

-XX	"D"
-RA/-NA	.06[1.5]
-RE/-NE	.16[4.1]

TABLE 5 "E"

LEAD STYL	RA SINGLE	RE SINGLE	RA DOUBLE	RA TRIPLE	NA SINGLE	NE SINGLE	NA DOUBLE	NA TRIPLE
08	.090 [2.29]	N/A	.090 [2.29]	.090 [2.29]	.109 [2.77]	N/A	.109 [2.77]	.109 [2.77]
09	.290 [7.37]	.190 [4.83]	.290 [7.37]	.290 [7.37]	.309 [7.85]	.209 [5.31]	.309 [7.85]	.309 [7.85]
10	.390 [9.91]	.290 [7.37]	.390 [9.91]	.390 [9.91]	.409 [10.39]	.309 [7.85]	.409 [10.39]	.409 [10.39]
11	.490 [12.45]	.390 [9.91]	.490 [12.45]	.490 [12.45]	.509 [12.93]	.409 [10.39]	.509 [12.93]	.509 [12.93]
12	.590 [14.99]	.490 [12.45]	.590 [14.99]	.590 [14.99]	.609 [15.47]	.509 [12.93]	.609 [15.47]	.609 [15.47]
13	.790 [20.07]	.690 [17.53]	.790 [20.07]	N/A	.809 [20.55]	.709 [18.01]	.809 [20.55]	N/A
16	.200 [5.08]	.100 [2.54]	.200 [5.08]	.200 [5.08]	.219 [5.56]	.119 [3.02]	.219 [5.56]	.219 [5.56]
21	.990 [25.15]	.890 [22.61]	N/A	N/A	1.009 [25.63]	.909 [23.09]	N/A	N/A
22	.190 [4.83]	.090 [2.29]	.190 [4.83]	.190 [4.83]	.209 [5.31]	.109 [2.77]	.209 [5.31]	.209 [5.31]
25	.100 [2.54]	N/A	.100 [2.54]	.100 [2.54]	.119 [3.02]	N/A	.119 [3.02]	.119 [3.02]
27	.890 [22.61]	.790 [20.07]	N/A	N/A	.909 [23.09]	.809 [20.55]	N/A	N/A
28	.690 [17.53]	.590 [14.99]	.690 [17.53]	N/A	.709 [18.01]	.609 [15.47]	.709 [18.01]	N/A
29	.800 [20.32]	N/A	N/A	N/A	.819 [20.80]	N/A	N/A	N/A
30	.600 [15.24]	N/A	.600 [15.24]	N/A	.619 [15.72]	N/A	.619 [15.72]	N/A

**PROPRIETARY NOTE**  
 THIS DOCUMENT CONTAINS INFORMATION  
 CONFIDENTIAL AND PROPRIETARY TO  
 SAMTEC, INC. AND SHALL NOT BE REPRODUCED  
 OR TRANSFERRED TO OTHER DOCUMENTS OR  
 DISCLOSED TO OTHERS OR USED FOR ANY  
 PURPOSE OTHER THAN THAT WHICH IT WAS  
 OBTAINED WITHOUT THE EXPRESSED WRITTEN  
 CONSENT OF SAMTEC, INC.

DO NOT SCALE DRAWING

SHEET SCALE: 3:1



520 PARK EAST BLVD, NEW ALBANY, IN 47150  
 PHONE: 812-944-6733 FAX: 812-948-5047  
 e-Mail: info@SAMTEC.com code 55322

DESCRIPTION:  
 .025[0.64] SQ. POST TERMINAL STRIP ASSEMBLY  
 DWG. NO.  
**TSW-XXX-XX-XXX-X-XX-XXX**  
 BY: KOLB 08/24/1988 SHEET 4 OF 6

TABLE 7 (-T PLATING ONLY)

LEAD STYLE	NUMBER OF BAND MARKS ALLOWED IN POST AREA			LEAD STYLE	NUMBER OF BAND MARKS ALLOWED IN POST AREA		
	PIN #1	PIN #2	PIN #3		PIN #1	PIN #2	PIN #3
*-05	*0	N/A	N/A	*-17	2	N/A	N/A
-06	1	N/A	N/A	*-18	2	N/A	N/A
-07	1	N/A	N/A	*-19	2	N/A	N/A
-08	0	0	0	*-20	2	N/A	N/A
-08 RA	0	0	0	*-21	2	N/A	N/A
-09	0	0	0	-21-RA	0	N/A	N/A
-09 RA	0	0	0	-21-RE	0	N/A	N/A
-09-RE	0	0	0	-22	0	0	0
-10	0	0	0	-22-RA	0	0	0
-10-RA	0	0	0	-22-RE	0	0	0
-10-RE	0	0	0	-23	1	N/A	N/A
-11	0	0	0	-24	1	N/A	N/A
-11-RA	0	0	0	-25	1	1	1
-11-RE	0	0	0	*-25-RA	1	0	0
-12	0	0	0	*-26	1	N/A	N/A
-12-RA	0	0	0	*-27	0	N/A	N/A
-12-RE	0	0	0	*-27-RA	0	N/A	N/A
-13	0	0	N/A	*-27-RE	0	N/A	N/A
-13-RA	0	0	N/A	*-28	0	0	N/A
-13-RE	0	0	N/A	*-28-RA	0	0	N/A
-14	1	N/A	N/A	*-28-RE	0	0	N/A
*-15	2	N/A	N/A	*-29	1	N/A	N/A
*-16	1	1	1	*-29-RA	1	N/A	N/A
*-16-RA	1	1	1	*-30	1	1	N/A
*-16-RE	1	1	1	*-30-RA	1	1	N/A

INS TO BE FLIPPED OPPOSITE OF SELECTIVE PLATING BEFORE BEING INSERTED

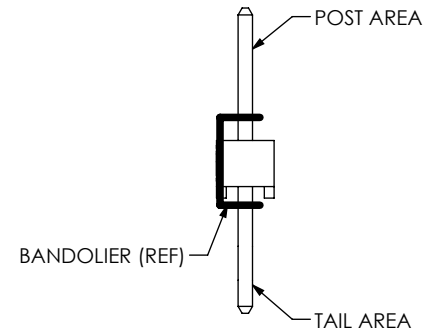

IN PROCESS 1  
 (SAME AS FIG. 1, DIFFERENT AS SHOWN)  
 -T PLATING ONLY  
 (SEE NOTE 11)  
 (SEE TABLE 7)

TABLE 4

PIN STYLE	"L" REF
T-1S6-07-XXX-2	0.430 [10.92]
T-1S6-08-XXX-2	0.530 [13.46]
T-1S6-09-XXX-2	0.730 [18.54]
T-1S6-10-XXX-2	0.830 [21.08]
T-1S6-11-XXX-2	0.930 [23.62]
T-1S6-12-XXX-2	1.030 [26.16]
T-1S6-13-XXX-2	1.230 [31.24]
T-1S6-14-XXX-2	1.430 [36.32]
T-1S6-15-XXX-2	0.630 [16.00]
T-1S6-16-XXX-2	0.445 [11.30]
T-1S6-17-XXX-2	0.480 [12.19]
T-1S6-18-XXX-2	0.300 [7.62]
T-1S6-19-XXX-2	1.330 [33.78]
T-1S6-20-XXX-2	1.130 [28.70]
T-1S6-21-XXX-2	0.335 [8.51]
T-1RS7-01-XXX-2	0.456 [11.58]

PROPRIETARY NOTE

THIS DOCUMENT CONTAINS INFORMATION CONFIDENTIAL AND PROPRIETARY TO SAMTEC, INC. AND SHALL NOT BE REPRODUCED OR TRANSFERRED TO OTHER DOCUMENTS OR DISCLOSED TO OTHERS OR USED FOR ANY PURPOSE OTHER THAN THAT WHICH IT WAS OBTAINED WITHOUT THE EXPRESSED WRITTEN CONSENT OF SAMTEC, INC.

DO NOT SCALE DRAWING

SHEET SCALE: 3:1



520 PARK EAST BLVD, NEW ALBANY, IN 47150  
 PHONE: 812-944-6733 FAX: 812-948-5047  
 e-Mail info@SAMTEC.com code 55322

DESCRIPTION:  
 .025[0.64] SQ. POST TERMINAL STRIP ASSEMBLY

DWG. NO.  
**TSW-XXX-XX-XXX-X-XX-XXX**

BY: KOLB 08/24/1988 SHEET 5 OF 6

TABLE 1				
TERMINAL SPECIFICATIONS				
TERMINAL SPEC	PIN #1	PIN #2	PIN #3	"C"
-05 (3)	T-1S6-21-XXX-2	N/A	N/A	0.105 [2.67] (5)
-06 (3)	T-1S6-18-XXX-2	N/A	N/A	0.105 [2.67] (5)
-07 (3)	T-1S6-07-XXX-2	N/A	N/A	0.230 [5.84] (5)
-08 (4)	T-1S6-08-XXX-2	T-1S6-09-XXX-2	T-1S6-11-XXX-2	(7)0.230 [5.84] (5)(6)
-09	T-1S6-09-XXX-2	T-1S6-11-XXX-2	T-1S6-20-XXX-2	0.230 [5.84] (6)
-10	T-1S6-10-XXX-2	T-1S6-12-XXX-2	T-1S6-13-XXX-2	0.230 [5.84]
-11	T-1S6-11-XXX-2	T-1S6-20-XXX-2	T-1S6-19-XXX-2	0.230 [5.84]
-12	T-1S6-12-XXX-2	T-1S6-13-XXX-2	T-1S6-14-XXX-2	0.230 [5.84]
-13	T-1S6-13-XXX-2	T-1S6-14-XXX-2	N/A	0.230 [5.84]
-14(3)	T-1S6-08-XXX-2	N/A	N/A	0.320 [8.13] (5)
-15 (3)	T-1S6-09-XXX-2	N/A	N/A	0.520 [13.21] (5)
-16	T-1S6-09-XXX-2	T-1S6-11-XXX-2	T-1S6-20-XXX-2	0.320 [8.13] (5)(6)
-17 (3)	T-1S6-10-XXX-2	N/A	N/A	0.620 [15.75] (5)
-18 (3)	T-1S6-11-XXX-2	N/A	N/A	0.720 [18.29] (5)
-19 (3)	T-1S6-12-XXX-2	N/A	N/A	0.820 [20.83] (5)
-20 (3)	T-1S6-13-XXX-2	N/A	N/A	1.020 [25.91] (5)
-21 (8)	T-1S6-14-XXX-2	N/A	N/A	1.220 [30.99] (5)
-21 (1)	T-1S6-14-XXX-2	N/A	N/A	0.230 [5.84] (5)
-22	T-1S6-15-XXX-2	T-1S6-10-XXX-2	T-1S6-12-XXX-2	0.230 [5.84] (5)(6)
-23 (3)	T-1S6-16-XXX-2	N/A	N/A	0.230 [5.84] (5)
-24 (3)	T-1S6-17-XXX-2	N/A	N/A	0.265 [6.73] (5)
-25 (4)	T-1S6-15-XXX-2	T-1S6-10-XXX-2	T-1S6-12-XXX-2	0.320 [8.13] (5)(6)
*-26 (3)	T-1RS7-01-XXX-2	N/A	N/A	0.230 [5.84]
-27	T-1S6-19-XXX-2	N/A	N/A	0.230 [5.84]
-28	T-1S6-20-XXX-2	T-1S6-19-XXX-2	N/A	0.230 [5.84]
-29(4)	T-1S6-19-XXX-2	N/A	N/A	0.320 [8.13]
-30 (4)	T-1S6-20-XXX-2	T-1S6-19-XXX-2	N/A	0.320 [8.13]

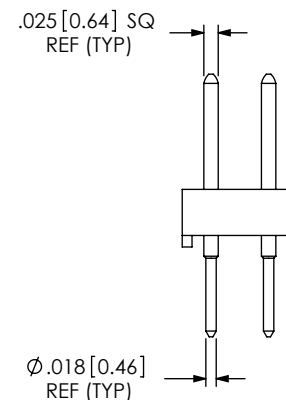

FIG 6  
(-26 LEAD STYLE)  
(SAME AS FIG. 1, DIFFERENT AS SHOWN)

(1) .230[5.84] POST FOR -RA OR -RE OPTION  
 (2) OMIT WITH -Q ROW SPECIFICATION  
 (3) NOT AVAILABLE IN -RA OR -RE OPTION  
 (4) NOT AVAILABLE IN -RE OPTION  
 \* SQUARE END OF PIN (T-1RS7-01-XXX-2 SHOULD BE LOCATED AT "C" DIMENSION DURING FILL PROCESS. (SEE FIG. 6)

(5) AVAILABLE IN -LL OPTION  
 (6) AVAILABLE IN -LA OPTION  
 (7) ON STYLE -08 -LA, RA: "C" = .230[5.84] ± .005[0.13] ± .008[0.20]  
 (8) 1.220[30.99] POST FOR STRAIGHT PIN VERSION

**PROPRIETARY NOTE**  
 THIS DOCUMENT CONTAINS INFORMATION CONFIDENTIAL AND PROPRIETARY TO SAMTEC, INC. AND SHALL NOT BE REPRODUCED OR TRANSFERRED TO OTHER DOCUMENTS OR DISCLOSED TO OTHERS OR USED FOR ANY PURPOSE OTHER THAN THAT WHICH IT WAS OBTAINED WITHOUT THE EXPRESSED WRITTEN CONSENT OF SAMTEC, INC.

DO NOT SCALE DRAWING

SHEET SCALE: 3:1

**samtec**  
 520 PARK EAST BLVD, NEW ALBANY, IN 47150  
 PHONE: 812-944-6733 FAX: 812-948-5047  
 e-Mail: info@SAMTEC.com code 55322

DESCRIPTION:  
 .025[0.64] SQ. POST TERMINAL STRIP ASSEMBLY

DWG. NO.  
**TSW-XXX-XX-XXX-X-XX-XXX**

BY: KOLB 08/24/1988 SHEET 6 OF 6