

IDMD-24-S-12.00-G

(2,54 mm) .100"

SLIM BODY FLAT RIBBON IDC CABLES

SPECIFICATIONS

For complete specifications see www.samtec.com?IDSS, www.samtec.com?IDSD, www.samtec.com?IDMS or www.samtec.com?IDMD

Insulator Material: Black Glass Filled Polyester
Plating: Au over 50µ" (1,27 µm) Ni or Sn over 100µ" (2,54 µm) Cu or 50µ" (1,27 µm) Ni

Wire: 28 AWG 7/36 stranded Tinned Copper
Temperature Range: -20°C to +105°C (Rainbow Cable) -40°C to +105°C (Gray Cable)

Contact IDSS/IDSD: BeCu
Terminal (IDMS/IDMD): Phosphor Bronze
Current Rating (IDSD/TST): 3.4 A per pin (1 position powered per row)
Current Rating (IDMD): 3 A per pin (1 position powered per row)

Contact Resistance: 15 mΩ
Lead Size Range: (0,56 mm) .022" SQ to (0,71 mm) .028" SQ
Lead Insertion Depth: (5,59 mm) .220" to (6,22 mm) .245"

Insertion Force: (Single contact only) 4 oz (1,11 N) avg. ((0,64 mm) .025" SQ probe)
Withdrawal Force: (Single contact only) 3 oz (0,83 N) avg. ((0,64 mm) .025" SQ probe)

RoHS Compliant: Yes

Mates with: TSW, MTSW, TSM, EJJ, PHT, HMTSW, HTSW, HW, DW, EW, ZW, MTLW

IDSD Mates with: TST, HTST, ZST, BST, EJJ

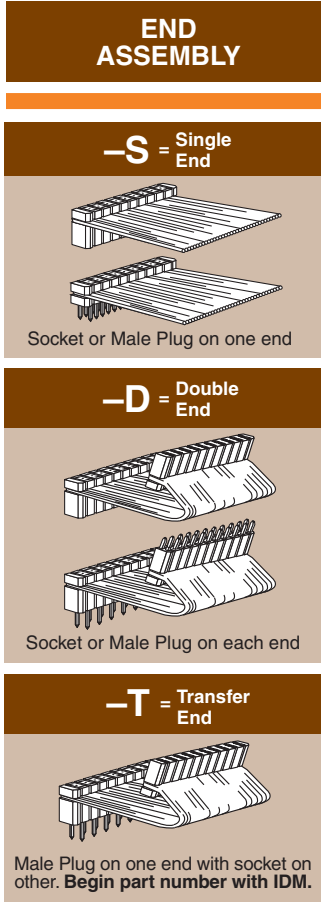
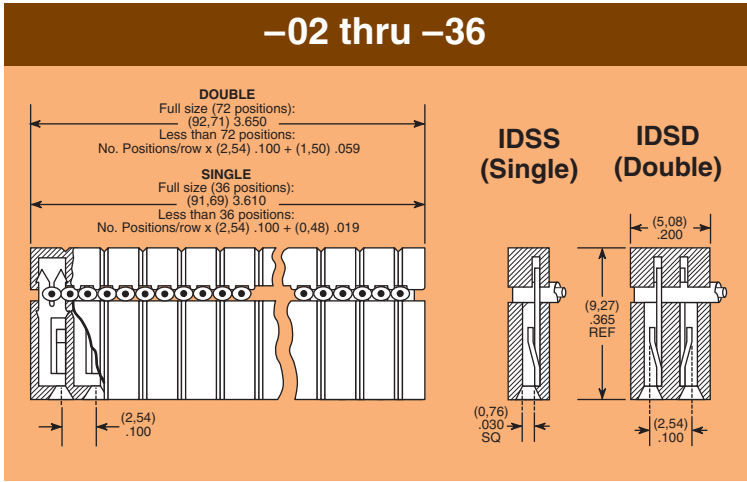
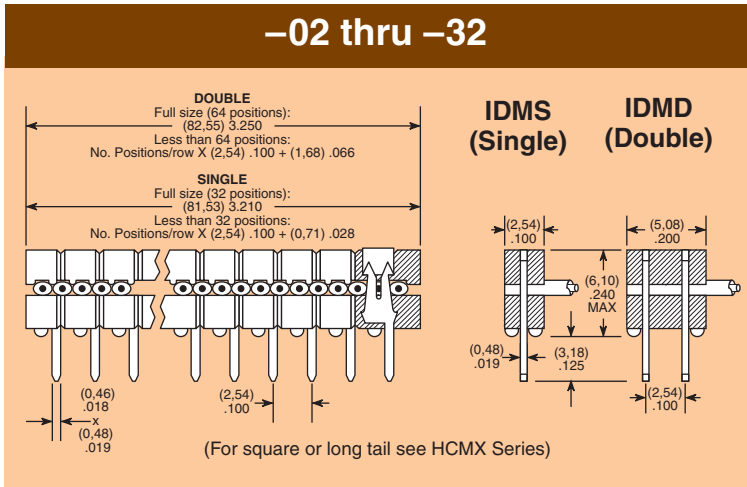
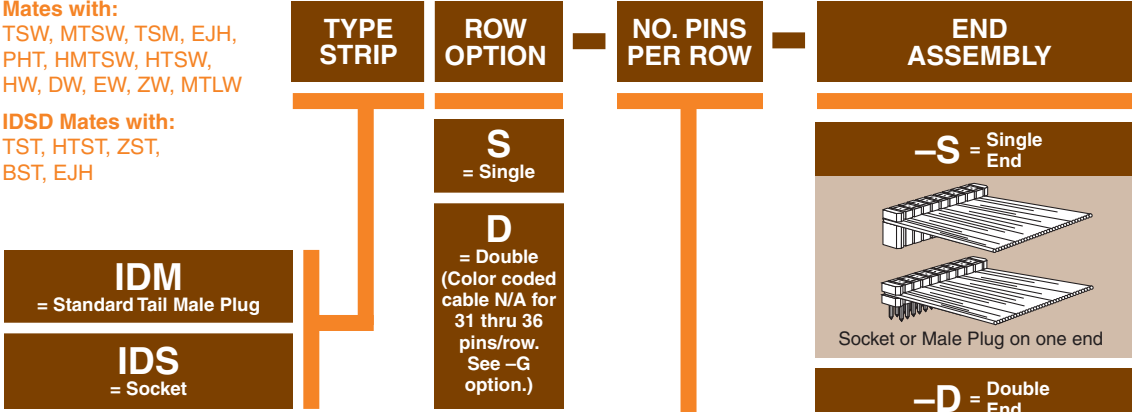

OTHER SOLUTIONS

Molded-To-Position IDC Assemblies

- Low Profile
- Skinny side locks
- Dual beam contacts
- Single and double row
- (3,05 mm) .120" and (5,84 mm) .230" length tail available

Call Samtec for HCXX Series.

RECOGNITIONS

For complete scope of recognitions see www.samtec.com/quality



Note: This Series is non-standard, non-returnable.

Due to technical progress, all designs, specifications and components are subject to change without notice.

WWW.SAMTEC.COM

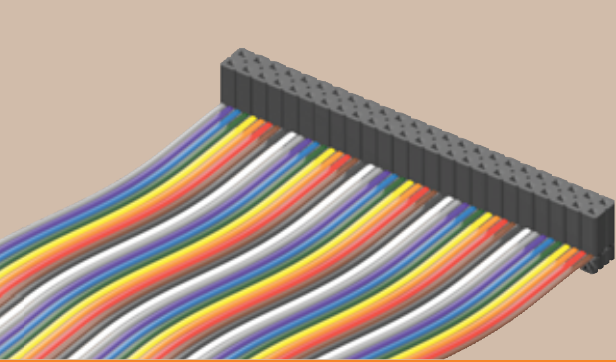

IDSD-24-S-05.00

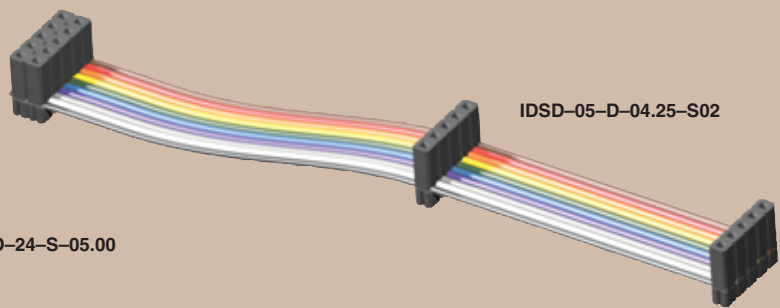

IDSD-05-D-04.25-S02

IDSS, IDSD, IDMS, IDMD SERIES

ASSEMBLED LENGTH

— “XX.XX”
= Assembled Length

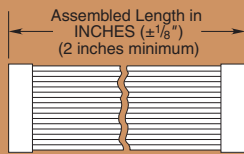

OPTION

POLARIZING KEY

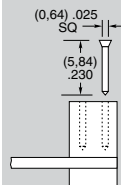

Optional polarizing key for use with IDSS & IDSD Series. Also polarizes SSW, SSQ, ESW & ESQ Series. Black High Temperature Thermoplastic

Order: Part Number PK-01-06
(Available in wheels of six each)

EJECTOR HEADERS & LOCKING CLIPS



- Ejector headers
- Locking clips

IDSS or IDSD STRIP ASSEMBLY

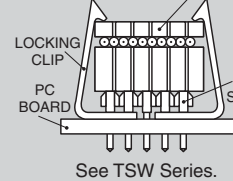

See TSW Series.

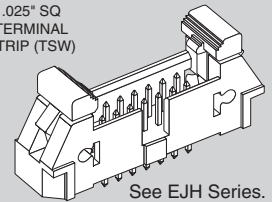

—T = Tin Plating (Both ends)

—C = Tin IDM = 10 μ m (0.25 μ m) Gold IDS (-T End Assembly Required)

—A = 10 μ m (0.25 μ m) Gold IDM = Tin IDS (-T End Assembly Required)

Standard plating is selective gold over BeCu contact for IDS; Selective gold over phosphor bronze for IDM.

1

—ST “X”
= Stripped & Tinned

Specify Suffix from table. All dimensions are $\pm 1/16"$. Not available in 28 positions and higher.

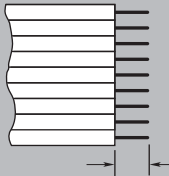

4

—S “XX”
= Daisy Chain Single

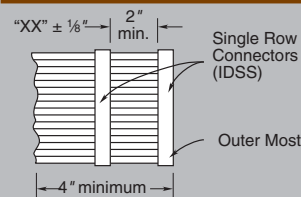

When mating double row connector with two single row connectors, the outer most single will be connected to Conductor #1 and the inside single to Conductor #2.

7

—R
= Reversed

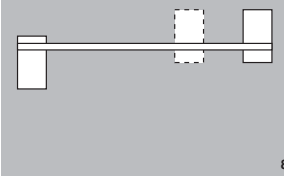

8

—P “XX”
= Polarized

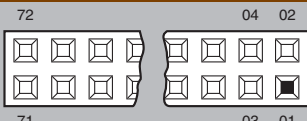

Specify “XX” as position. For Double the same position will be polarized on both ends. (Not available on IDM or EDM, unless transfer, then only the socket is polarized.)

2

—B “XX”
= Breakout

Specify “XX” as number of conductors to be broken out.

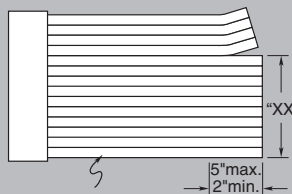

Breakout starts with Number 1 lead indicated by brown wire or red stripe. Shown on top side.

5

—D “XX”
= Daisy Chain, Double

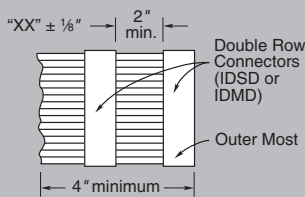

7

—M
= Middle Reversed

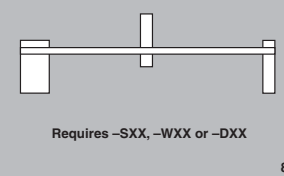

8

—G
= Gray Cable

Specify —G for Gray cable. Gray cable has one red edge. IDSS and IDMS uses .100" centerline cable. IDSD and IDMD uses .050" centerline cable. Cable is 28 AWG 7/36 copper wire. Standard cable is same as above except color coded.

3

—RW
= Reversed Wiring

#1 wire opposite position #1.

6

—W “XX”
= Wiring Reversed Daisy Chain, Single

Same as —S “XX” except outer strip connected to Conductor #2 and inside strip connected to Conductor #1.

7

—O
= Outside Reversed

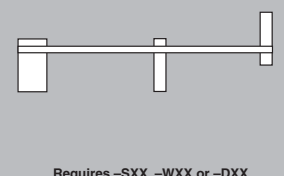

8

Due to technical progress, all designs, specifications and components are subject to change without notice.

WWW.SAMTEC.COM