



MORE POWER. MORE FLEXIBILITY. MORE SPEED.

Like our popular C200H/HS mid-size PLC series, Omron's new C200Hα series offers the advantages of large PLC performance and I/O versatility in a mid-size PLC package and price range. But there's more to the new C200Hα series—a lot more.

Improvements to the existing series, such as greater memory capacity and faster processing speed, strengthen the C200Hα series' capabilities as a controller. Newly added features, such as a protocol macro and an optional PCMCIA Card Module, transform the C200Hα series into a powerful on-site data processing system—and transforms your workplace into a highly responsive, information-based operation.

► More I/O Points

C200HS	880
C200Hα	1,184 maximum

► More Special I/O Modules

C200HS	10
C200Hα	16

► Increased Processing Speed

C200HS	0.375 μs LD execution
C200Hα	0.1 μs LD execution speed

► Increased Memory Capacity

C200HS	15.2k words
C200Hα	31.2k words maximum

► Increased Data Memory

C200HS	6K words
C200Hα	24K words maximum

► Enlarged SYSMAC LINK Data Link Area

C200HS	918 words
C200Hα	2,966 words

► Increased Local Expansion

C200HS	2 expansion backplanes max.
C200Hα	3 expansion backplanes max.

WHY OMRON?

Quality Recognized Industry-Wide

Omron performs 100% quality inspection and testing procedures at every stage of manufacturing – your assurance of satisfaction.

Your 24-Hour Automation Solution

Get Omron's SmartFactory advantage by utilizing our application engineering know-how, extensive training, and 24-hour technical support from anywhere in the USA. Through our commitment to flexible manufacturing, Omron has become a leader in the manufacture of Sensors, Digital Panel Meters, Digital Displays, Counters, Timers, PLCs, Process and Temperature Controllers, and other control devices.

Technical Information FAST

Obtain up-to-date technical specifications for all Omron products 24 hours a day, 7 days a week from your fax machine. Call our **ControlFax at 847.843.1963**. Request #50 for a directory of all documents available.

Information is also available on the internet. Visit our web site at <http://oei.omron.com> and get the latest information on Omron products and literature.

Worldwide Sales and Support Network

You'll find over 200 stocking distributors and local sales offices across the United States. With distributors in Canada and Mexico, and branch offices worldwide, Omron provides replacement components, service and multilingual documentation virtually anywhere in the world.

Expertise You Can Rely On

You can rely on the high quality PLC products you've come to expect from Omron. Trust our nationwide network of local stocking distributors and system integrators to offer expertise you can depend on. **Just give us a call.**



SECTION	PAGE NUMBER
SYSTEM COMPONENTS	1
System Overview	
Introduction	2
Overview	6
PLC System specifications	8
CPU	
Features	9
Selection Guide	10
Specifications and Characteristics	11
Communication Boards	14
Protocol Macro Function	15
Memory Cassettes	17
Power Supply Modules	18
Backplanes	19
Connecting I/O Cables	21
Discrete I/O Modules	22
Special I/O Modules	26
COMMUNICATIONS	69
Overview	70
Communication Modules	72
Fiber-optic Cable and Connections	89
PROGRAMMING	91
Programming Software	
SSS and SYSWIN	92
Protocol Support Software	94
Programming Peripherals and Cables	97
Programming Instructions	99
STANDARD PARTS	123
COMPLEMENTARY PRODUCTS	141
Operator Interface Terminals	142
PART NUMBER INDEX	149

NOTE: Specifications to change without notice.

Warranty: Omron certifies all of its products either meet or exceed stipulated specifications. Omron is not liable for stenographic and/or clerical errors.

Omron's obligation under this warranty is limited solely to repair or replacement at Omron's discretion. Omron will not be liable for any design furnished by Buyer and incorporated into equipment.

This warranty is voided if the product is altered in any way or suffers consequential damage due to negligence or misuse.

Omron is not to suffer risk due to the suitability or unsuitability or the results of the use of its products used in combination with any electrical or electronic components, circuits, systems assemblies or any other materials or substances or environments.

The foregoing warning is the only warranty which Omron Electronics, Inc., provides with respect to the products listed herein. No other warranties, expressed, implied, or statutory shall apply, whether as to merchantability, fitness for a particular purpose, description, or otherwise.

Limitation of Liability: Notwithstanding any other statement herein, Omron Electronics, Inc., its contractors and suppliers, shall not be liable for any special, indirect, incidental or consequential damages. The remedies of the purchaser set forth herein are exclusive where so stated and the total cumulative liability of Omron Electronics, Inc., its contractors and suppliers, with respect to this contract or anything done in connection therewith, shall not exceed replacement price reimbursement as to the product on which such liability is based.



SYSTEM COMPONENTS

1

System Overview

Introduction	2
Overview	6
PLC System specifications	8

CPU

Features	9
Selection Guide	10
Specifications and Characteristics	11
Communication Boards	14
Protocol Macro Function	15
Memory Cassettes	17
Power Supply Modules	18

Backplanes

Connecting I/O Cables

Discrete I/O Modules

Special I/O Modules

19
21
22
26

The New C200H α Series:

Powerful Mid-Sized Machine Control, Powerful Onsite Data Processing

Migrate Easily

While the functions and capabilities of the C200H α series have been dramatically enhanced, common languages and I/O units allow smooth migration from C200H/HS PLCs.

Improved Special I/O Modules

The maximum number of Special I/O Modules that can be mounted on the CPU has been increased from 10 to 16 modules. You can easily manage a control system with the right combination of Special I/O Modules.

The intelligent I/O read and intelligent I/O write instructions can be executed to transfer more than one word of data. All of the C200HS Special I/O Modules can be used without any modification. In addition, a PC Card Module, Motion Control Module, and Two-axis High-speed Counter Module have been added.

Interface to Memory or Ethernet via PC Card Module

The **PC Card Module** provides two PCMCIA interface slots. Either two type I or II or one type III PC card can be installed. The system accepts SRAM, FLASH and ATA cards.

PC File Operations: C200HX/HG/HE memory contents may be written to memory cards as files using ladder-diagram instructions. File contents can be compared and searched and word data can be separated by commas in the file format so that commercially available spreadsheets may be used.

Ethernet Connection: Using an Ethernet PCMCIA card, data may be exchanged using Omron's FINS protocol via UDP/IP.

A Built-in Protocol Macro Function

Previously, it was necessary to write a communications program for the ASCII Module or BASIC Module whenever a measurement device or component was connected to the PLC. The C200H Alpha PLCs are equipped with the Protocol Macro Function which incorporates these communications programs into the ladder program with just a few ladder instructions. A variety of workplace data can be processed in real-time improving quality and reducing total product cost. System development time can be reduced substantially.

Build Networks Easily with the Alpha's Built-in Features.

Using built-in Host Link function of the C200H Alpha, connect directly to operator interface terminals using a cable as an interface, or use a One-to-One data links between alpha PLCs are just as easy to make.

When networking with a PC, the TXD and RXD instructions can be used to carry out RS-232C communications from the PLC, and the STUP instruction can be used to switch between Host Link and RS-232C, communications.

Open up Your Communications Possibilities in All Three Automation Network Levels

DEVICE LEVEL NETWORKS: The new C200HW-DRM21 Module supports DeviceNet open multi-vendor network communications. DeviceNet makes it possible to connect devices that have a wide variety of parameters or data, such as inverters or analog devices. It also allows other DeviceNet products to be connected as well.

CONTROL LEVEL NETWORKS: Omron's SYSMAC Link and SYSMAC Net networks provide high-speed real-time data transfer. SYSMAC Link's data link capacity has been increased from 918 words to 2,966 words.

INFORMATION LEVEL NETWORKS: The C200HW-PCS01 PCMCIA Module allows data exchange with CV Ethernet units, PCs and workstations using Omron's FINS protocol via Ethernet UDP/IP.

Connect to a Variety of Serial Devices

The C200H α CPU's can be equipped with one of six communication boards. By installing the appropriate communication board, the CPU can communicate with SYSMAC Link / SYSMAC Net modules, a PC Card module or serial devices. Using the Protocol Macro Function built into the C200HW-COM04-E, C200HW-COM05-E or C200HW-COM06-E communications boards, communications sequences for one of seven types of installed Omron protocols may be used or customized for a modem, operator interface, bar code reader, temperature controller, or any kind of RS-232C, RS-422 or RS-485 device.



BUILD YOUR OWN CONTROL AND DATA PROCESSING SYSTEM

CPU

- Choose from 11 CPU models
- Separate CPU and power supply

CPU and Expansion Backplanes

- CPU and power supply mount on a dedicated CPU backplanes
- Local expansion may be done with the new space-saving C200H α expansion backplanes or current C200H backplanes
- Connect up to 5 remote I/O backplanes

Special I/O

- Take full advantage of the C200H α 's power with any combination of 20 Special I/O Modules

Communications

- All CPUs include a multifunctional peripheral port to communicate to programming peripherals
- Standard Host Link port is built into selected CPUs
- One of six communications boards can also be installed in the CPU. When used with the protocol macro function, these boards provide a simple way to connect with a SYSMAC Link or SYSMAC Net Link module, to communicate with a Modem, operator interface, bar code reader, Process Controller or any kind of RS-232C, RS-422 or RS-485 device.

Software Support

- Supported by both SYSMAC Support Software Version 1.2 or greater and SYSWIN version 3.0 or greater

CPU RACK



p. 19
CPU BACKPLANE
C200HW-BC031 C200HW-BC051
C200HW-BC081 C200HW-BC101



p. 17
EPROM MEMORY CASSETTES
4K words C200HW-ME04K
8K words C200HW-ME08K
16K words C200HW-ME16K
32K words C200HW-ME32K

EPROM MEMORY CASSETTES
16/32K words C200HS-MP16K



p. 9
CPUs
C200HE-CPU11-E C200HE-CPU32-E
C200HG-CPU33-E C200HX-CPU34-E
C200HG-CPU43-E C200HX-CPU44-E
C200HG-CPU53-E C200HX-CPU54-E
C200HG-CPU63-E C200HX-CPU64-E



p. 18
POWER SUPPLY MODULE
C200HW-PA204
C200HW-PA204S
C200HW-PD024

EXPANSION I/O RACK



p. 21
I/O CONNECTING CABLE
C200H-CN□□1
(30cm, 70cm, 2m, 5m, 10m)



p. 18
POWER SUPPLY MODULE
C200HW-PA204
C200HW-PA204S
C200HW-PD024



p. 19
EXPANSION I/O BACKPLANE
C200HW-BI031
C200HW-BI051
C200HW-BI081
C200HW-BI101

SLAVE RACKS



p. 84
REMOTE I/O SLAVE MODULE
Fiber-optic, 100/200 VAC C200H-RT001-P
Fiber-optic, 24 VDC C200H-RT002-P
Wired, 100/200 VAC C200H-RT201
Wired, 24 VDC C200H-RT202



p. 20
SLAVE I/O BACKPLANE
C200H-BC031-V2
C200H-BC051-V2
C200H-BC081-V2
C200H-BC101-V2

COMMUNICATIONS BOARDS (cannot be mounted to the CPUHE-CPU11-E)



p.14

C200HW-COM01



p.14

C200HW-COM02



p.14

C200HW-COM03



p.14

C200HW-COM04-E



p.14

C200HW-COM05-E



p.14

C200HW-COM06-E

COMMUNICATIONS MODULES



p.81

DEVICENET SCANNER
C200HW-DRM21



p.85

HOST LINK
C200H-LK202-V1
C200H-LK101-PV1
C200H-RM201-V1



p.87

PC LINK
C200H-LK401



p.72

PC CARD*
C200HW-PCU01
Ethernet Set*
C200HW-PCS01-E



p.83

REMOTE I/O MASTER
Fiber-optic
C200H-RM001-V1
Wired
C200H-RM201-V1



p.78

SYSMAC LINK*
Coaxial
C200HW-SLK23/24
Fiber-optic
C200HW-SLK13/14



p.75

SYSMAC NET LINK*
C200HS-SNT32

*Use these modules together with communications boards (C200H-COM01/04-E) in the CPU Rack.

SPECIAL I/O MODULES



p.40

ANALOG INPUT
C200H-AD001
C200H-AD002



p.41

ANALOG OUTPUT
C200H-DA001
C200H-DA002



p.62

ASCII/BASIC
C200H-ASC02



p.60

CAM POSITIONER
C200H-CP114



p.51

FUZZY LOGIC
C200H-FZ001



p.58

HIGH-SPEED COUNTER
C200H-CT000



p.66

RFID SENSOR
C200H-IDS00



p.53

DUAL-AXIS MOTION CONTROL
C200H-MC221



p.48

PID CONTROL
C200H-PID00



p.56

POSITION CONTROL
C200H-NC211
C200H-NC112



p.42

TEMPERATURE SENSOR
C200H-TS000



p.44,46

TEMPERATURE CONTROL
C200H-TC000
C200H-TV000



p.64

VOICE
C200H-OV001



p.26

B7A INTERFACE
16 points
C200H-B7A01



p.26

B7A INTERFACE
32 points/64 points
C200H-B7A00
(cannot be used on Slave rack)



p.29,34

HIGH DENSITY INPUT
C200H-ID000
Group 2 C200H-ID210



p.30,36

HIGH DENSITY OUTPUT
C200H-OD000
Group 2 C200H-OD210



p.31

ANALOG TIMER
C200H-TM001



p.38

MIXED I/O
16 inputs/16 outputs
C200H-MD000



p.32

INTERRUPT INPUT
C200HS-INT01
(CPU Backplane ONLY)

DISCRETE I/O MODULES



p.22

8 POINT INPUT
C200H-I0000



p.22

16/32 POINT INPUT
C200H-I0000



p.22

5/8/16 POINT OUTPUT
C200H-O0000



p.22

12/32 POINT OUTPUT
C200H-O0000

SYSTEM OVERVIEW

BASIC CONFIGURATION - C200HX/HG/HE

CPU Rack

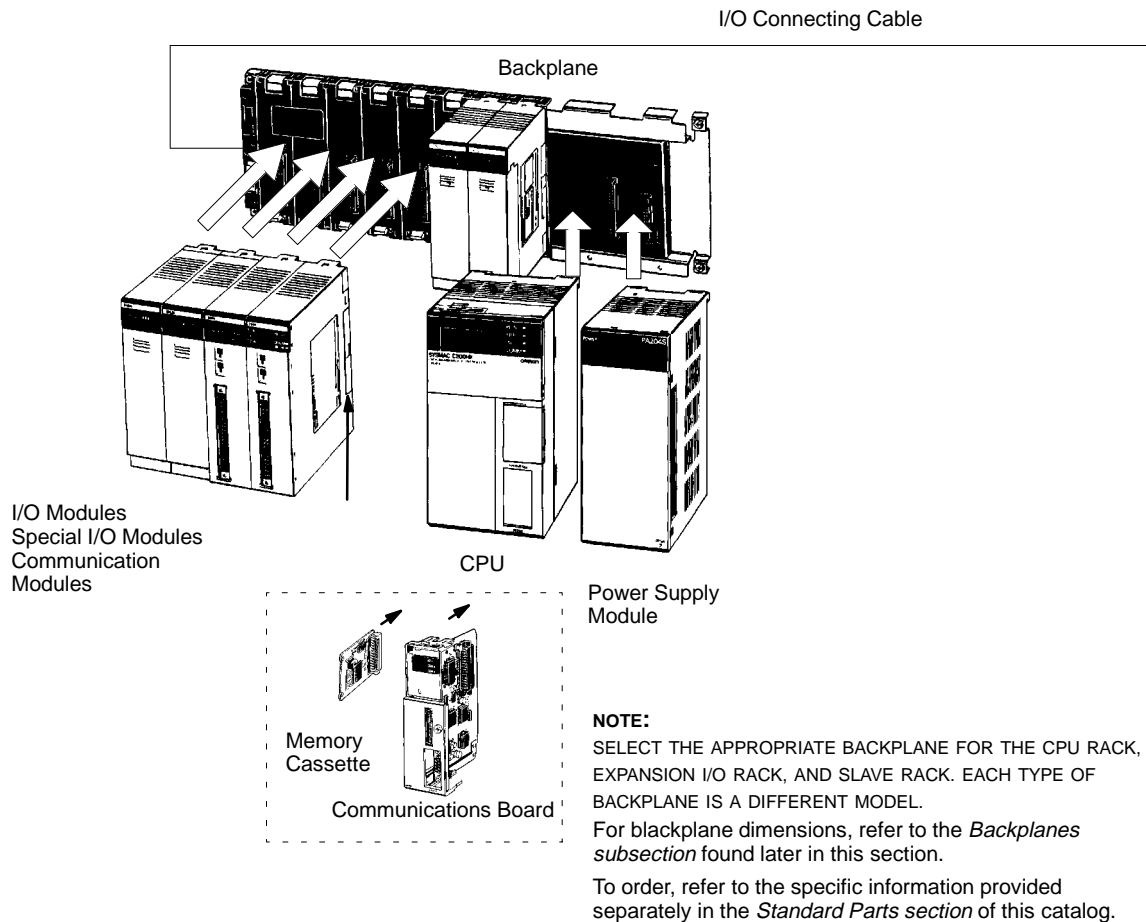

CPU Rack

The CPU Rack is the master controller rack for the control systems and contains the system communications ports. It may be expanded using Expansion Racks and Slave Racks.

A fully configured C200H α CPU Rack includes a CPU, Backplane, Power Supply Module, I/O Modules, Special I/O Modules and Communication Modules, as appropriate for the application.

A complete system may also include connecting cables and programming software or hardware.

A total of two SYSMAC LINK or SYSMAC NET Link Modules can be mounted to the CPU if the C200HW-COM01 or C200HW-COM04-E Communications Board is connected to the CPU.

Only two C200HS-INT01 Interrupt Input Modules can be mounted on a CPU Rack.

SYSTEM OVERVIEW

BASIC CONFIGURATION – C200HX/HG/HE

Expansion I/O Racks

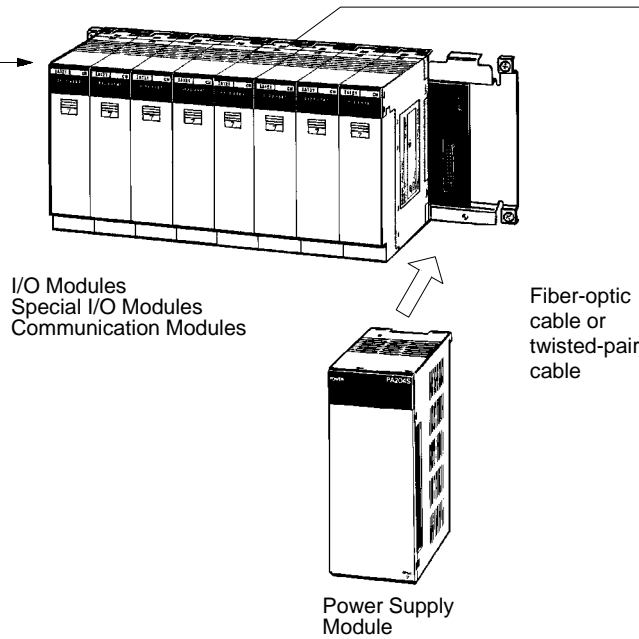

Slave Racks

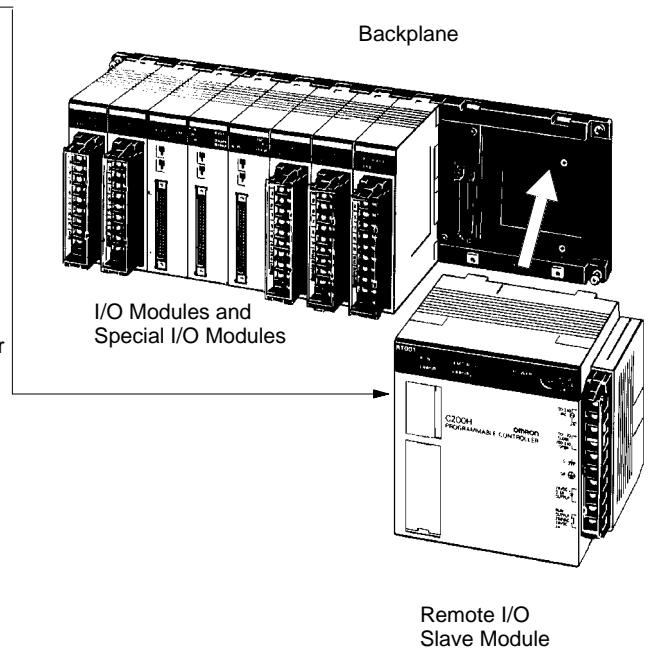

Local Expansion Racks

The configuration of an Expansion I/O Rack includes a Power Supply Module, an Expansion Backplane, and appropriate I/O Modules, Special I/O Modules, and Communication Modules.

The number of allowable Expansion Racks varies with CPU model.

Up to three Expansion I/O Racks can be connected to the C200HX-CPU54-E, C200HX-CPU64-E, C200HG-CPU53-E, or C200HG-CPU63-E.

Up to two Expansion I/O Racks can be connected to any other CPU for the C200HX, C200HG, and C200HE.

Different types of Backplanes are necessary for the CPU, Expansion I/O Rack, and the Slave Rack.

Slave Racks

To expand a system and minimize wiring costs, you may connect a maximum of five Slave Racks per system.

The Configuration of a Slave Rack includes a Remote I/O Slave Module, a Backplane (for the C200HX/HG/HE Slave Rack), I/O Modules, and Special I/O Modules.

To mount a High-density I/O Module to a Slave Rack, use a C200H-RM001-PV1/RM201.

Note: C200H-RM001-P Master Modules cannot be used.

Group-2 High-density I/O Modules, Communications I/O Modules, and Interrupt Input Modules cannot be mounted in Slave Racks.

You can connect a Maximum of two Expansion I/O Racks to Slave Racks using I/O Connecting Cable.

Always count the Expansion I/O Racks (connected in this way) against the maximum of five Slave Racks that can be connected.

SYSTEM OVERVIEW

C200HX/HG/HE SPECIFICATIONS

C200H α PLC – System Specifications

ITEM	SPECIFICATIONS
Supply voltage	AC power supply: 100 to 120/200 to 240 VAC selectable 50/60 Hz DC power supply: 24 VDC
Operating voltage range	AC power supply: 85 to 132/170 to 264 VAC DC power supply: 19.2 to 28.8 VDC
Power consumption	AC power supply: 120 VA max. DC power supply: 50 W max.
Surge current	30 A max.
Output capacity	4.6 A, 5 VDC; 0.6 A, 26 VDC; 0.8 A, 24 VDC ^{+10%/-20%} (C200HW-PA204S only)
Insulation resistance	20 M Ω between AC terminals and the GR terminal at 500 VDC (see note 1)
Dielectric strength	2,300 VAC at 50/60 Hz for 1 minute between AC terminals and housing; 1,000 VAC at 50/60 Hz for 1 minute between DC terminals and housing. Leakage current: 10 mA max. (see note 1)
Noise immunity	1,500 Vp-p, pulse width: 100 ns to 1 μ s, rise time: 1 ns pulse (by noise simulator)
Vibration	10 to 57 Hz; 0.075 mm amplitude, 57 to 150 Hz; acceleration: 1 G, in X, Y, and Z directions, for 80 minutes each (sweep time 8 min x 10 sweeps = 80 min); (When mounted on DIN track, 2 to 55 Hz, 0.3 G, in X, Y, and Z directions for 20 minutes each)
Shock	15G (147 m/s ²) in X, Y, and Z directions, 3 times each
Ambient temperature	Operating: 0 to 55°C (32° to 131.0°F) Storage: -20 to 75°C (-4.0 to 167.0°F) without battery
Humidity	10% to 90% (without condensation)
Atmosphere	Must be free of corrosive gases
Grounding	Less than 100 Ω
Enclosure rating	IEC IP30 (mounted in a panel)
Weight	6 kg max. (CPU: 315 g max., Power Supply Module: 510 g max., Backplane: 445 g to 1040 g)

Note: Be sure to disconnect the LG and GR terminals when conducting insulation resistance tests or dielectric strength tests. Internal components might be damaged if insulation resistance tests are repeated many times with the LG and GR terminals connected.

Features

Select from Eleven C200H α CPUs within Alpha's Three Basic Model Types

Each model has different program capacities, processing speeds, I/O capabilities, communications connections and features. (The C200H α CPU Selection Table is provided later in this section.)

Optional Back-up Memory Cassettes

For program back-up or rewrite option, each CPU has a special Memory Cassette compartment.

Multifunctional Peripheral Port

Directly connect to programming peripherals or communicate to Omron's Operator Interface Terminals and other third party devices using an optional CIF Convertor Cable.

Built-in RS-232C Port

Direct Host Link communications to the CPU or interface with other devices through serial communications. Available on selected models only.

Versatile Communications

Install one of six C200H α Communications Boards to have additional communications ports. The boards fit into the communications slot in the CPU and enable communication with SYSMAC LINK or SYSMAC NET modules, a PC card module or a variety of serial devices – including Operator Interfaces. Order the Communications Board and Memory Cassette separately (not provided with the CPU).

Protocol Macro

Three C200H α Communications Boards offer the Protocol Macro Instruction that controls data transfer with various communications devices and components equipped with RS-232C or RS-422/485 ports. With the Protocol Macro Function built into the C200HW-COM04, C200HW-COM05-E and C200HW-COM06-E Communications Boards, communications sequences (data transfer procedures) may be modified with Omron's Protocol Support Software.

Although seven Omron Communications sequences are built-in, you can use the Protocol Support Software to create other communications sequences. For more details, refer to the *Communication Board section* that follows.

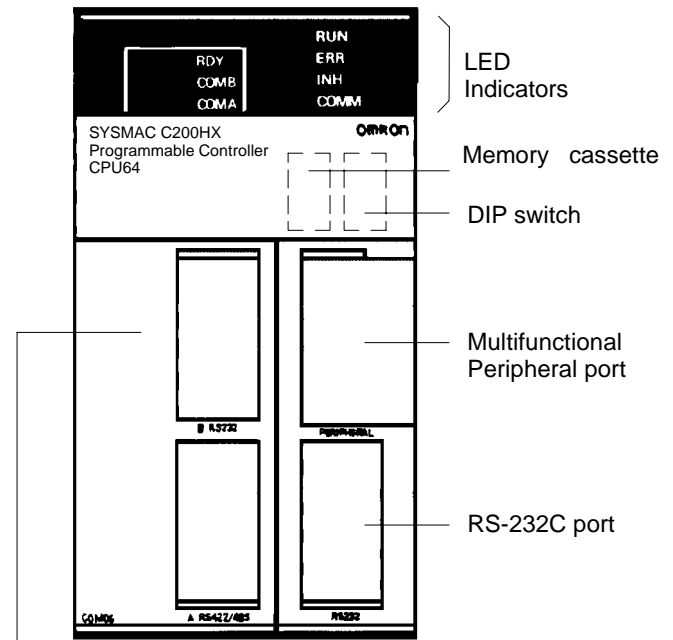

Communications Board (C200HW-COM06-E shown here)

Indicators

INDICATOR ON THE CPU	FUNCTION
RUN (green)	Lit when the PLC is operating normally.
ERR (red)	Flashes if the PLC in operation detects any non-fatal error. (The PLC will continue operating.) Lit if the PLC in operation detects any fatal error. (The PLC will stop operating.) After the PLC stops operating, the RUN indicator will be off, and all output signals of the Output Modules will be interrupted.
INH (orange)	Lit when the Load OFF flag (AR bit) is ON. (All output signals of the Output Modules will be interrupted.)
COMM (orange)	Flashes when the CPU is communicating with the device connected to the peripheral port or RS-232C port.

CPU

C200HX/HG/HE CPU SELECTION GUIDE

Consider these Application Needs when Selecting the C200H α CPU

1. What is the required program capacity?
2. Determine total standard I/O (with expansion rack) and Special I/O requirements.
3. What communications interfaces are required?

C200H α CPU Selection Table

PROGRAM CAPACITY (WORDS)	DM (WORDS)	EM (WORDS)	BASIC INSTRUCTION PROCESSING TIME	NO. I/O PTS.	MAX. NO. EXPANSION I/O RACKS)	MAX. NO. HIGH-DENSITY I/O MODULES (GROUP 2) NO. BELOW = TOTAL NO. OF MODULES	MAX. NO. OF SPECIAL I/O MODULES (GROUP 1) NO. = TOTAL NO. OF MODULES	RS-232C	CLOCK FUNCTION	COMMUNICATIONS BOARD AVAILABLE	PART NUMBER
3.2K	4K	None	0.3 μ s min.	640	2	Unavailable	10	No	No	No	C200HE-CPU11-E
7.2K	6K			880		10		Yes	Yes	C200HE-CPU32-E C200HE-CPU42-E	
15.2K	6K	6K	0.15 μ s min.	880	2	10	10	No	Yes	Yes	C200HG-CPU33-E C200HG-CPU43-E
				1,184				3			
				1,184	3	16 (10) <i>See Note</i>	16 (10) <i>See Note</i>	Yes			
31.2K	6K	6K x 3 (18K)	0.1 μ s min.	880	2	10	10	No	Yes	Yes	C200HX-CPU34-E C200HX-CPU44-E
				1,184				3			
				1,184	3	16 (10) <i>See Note</i>	16 (10) <i>See Note</i>	Yes			

Note: When the table indicates a selection total of 16 High-density I/O Modules or Special I/O Modules – the total of 16 is applicable only if you select from the Modules in this list:

- High-density I/O Modules: C200H-ID216 (32 inputs) and C200H-OD218 (32 outputs).
- Special I/O Modules: C200H-AD002, C200H-DA002, C200H-NC211, and C200H-CT021

If your selections are not in the list above: you may be limited to only 10 modules – as indicated in the table.

An exception: A total of only 8 can be used if you select C200H-OD219, C200H-ID217, or C200H-ID111 High-density I/O Modules.

C200H α CPU Characteristics

ITEM	SPECIFICATIONS
Control method	Stored program
I/O control method	Cyclic scan with direct output and immediate interrupt processing are both possible.
Programming method	Ladder diagram
Instruction length	1 address/instruction, 1 to 4 words/instruction
Number of instructions	14 basic instructions, 231 special instructions
Execution time	Basic instructions: e.g., LD C200HE-CPU□□-E:0.3 μ s C200HG-CPU□□-E:0.15 μ s C200HX-CPU□□-E:0.1 μ s Special instructions: e.g., MOV(21) C200HE-CPU□□-E:1.2 μ s C200HG-CPU□□-E:0.6 μ s C200HX-CPU□□-E:0.4 μ s
Program capacity	C200HE-CPU11-E: 3.2K words max. C200HE-CPU32-E/CPU42-E: 7.2K words max. C200HG-CPU□□-E: 15.2K words max. C200HX-CPU□□-E: 31.2K words max.
I/O bits	640 (00000 to 02915, 30000 to 30915)
IR bits	6,464 (03000 to 23115, 31000 to 51115)
SR bits	1,080 (23200 to 25507, 25600 to 29915)
TR bits	8 (TR 0 to 7)
HR bits	1,600 (HR 0000 to 9915)
AR bits	448 (AR 0000 to 2715)
LR bits	1,024 (LR 0000 to 6315)
Timers/Counters	512 (TIM/CNT 000 to 511)
DM words	Read/Write: 6,144 (DM 0000 to 6143) Read-only: 512 (DM 6144 to 6655) Expansion: Up to 3,000 words max. (DM 7000 to 9999)
EM words	Read/Write: C200HE-CPU□□-E: None C200HG-CPU□□-E: 6,144 (EM 0000 to EM 6143) C200HX-CPU□□-E: 6,144 \times 3 banks (EM 0000 to EM 6143)
Power failure backup function	Holds HR, AR, CNT, DM, and EM and clock (RTC) contents.
Memory backup time	The battery service life is five years at 25°C (77°F). The service life will be shortened if the battery is used at higher temperatures. Replace the battery within one week after the battery alarm indicator starts flashing. When replacing the battery, install the new battery within five minutes after removing the old one.
Self-diagnostic function	CPU errors (watchdog timer), I/O verification errors, host link errors, memory errors, battery errors, I/O bus errors, remote I/O errors, etc.
Program check function	Checks the program from the time the program starts running and checks the omission of the END instruction or any other improper instruction. This function allows three-level checking of programs through the Programming Console.

CPU

SPECIFICATIONS, CHARACTERISTICS

Comparing C200H α CPU Specifications

Use the following table to compare the functions of the C200HX, C200HG, and C200HE with those of the C200HS and C200H.

FUNCTION		C200HX/HG/HE	C200HS	C200H
Memory	User Memory (UM)	3.2K words (C200HE-CPU11-E) 7.2K words (C200HE-CPU□2-E) 15.2K words (C200HG-CPU□3-E) 31.2K words (C200HX-CPU□4-E)	15.2K words	3.2K words/7.2K words
	Normal Data Memory (DM)	C200HX/G: 6,144 words (DM 0000 to DM 6143) (DM 4000 to DM 5999 do not exist in the C200HE-CPU11-E) C200HE-CPU16: 4000 words (DM0000-3999)	6,144 words (DM 0000 to DM 6143)	1,000 words (DM 0000 to DM 0999)
	Fixed Data Memory	512 words (DM 6144 to DM 6655)	512 words (DM 6144 to DM 6655)	1,000 words (DM 1000 to DM 1999)
	Fixed Expansion Data Memory	0 to 3,000 words (DM 7000 to DM 9999)	0 to 3,000 words (DM 7000 to DM 9999)	None
	Extended Data Memory (EM)	C200HE: No EM C200HG: 6,144 words x 1 bank C200HX: 6,144 words x 3 banks	None	None
I/O	Expansion Racks	3 max. (2 max. for C200HE-CPU□□-E and C200HG/HX-CPU-3□-E/4□-E)	2 max.	2 max.
	Group-2 High-density I/O Modules	0 to 9 and A to F Modules per PLC C200HE-CPU11-E: No Group-2 Modules connected C200HE-CPU□2-E, C200HG/HX-CPU-3□-E/CPU4□-E: 0 to 9 Units per PLC	0 to 9 Modules per PLC	0 to 9 Modules per PLC
	Special I/O Modules	0 to 9 and A to F Modules per PLC C200HE-CPU□□-E, C200HG/HX-CPU-3□-E/CPU4□-E: 0 to 9 Modules per PLC	0 to 9 Modules per PLC	0 to 9 Modules per PLC
Execution time	Basic instructions (LD)	0.1 μ s (C200HX) 0.15 μ s (C200HG) 0.3 μ s (C200HE)	0.375 μ s	0.75 μ s
	Special instructions (MOV)	0.4 μ s (C200HX) 0.6 μ s (C200HG) 1.2 μ s (C200HE)	19 μ s	88 μ s
	Other special instructions	C200HX and C200HG: Approx. 1/3 to 2/3 of the time required by the C200HS. C200HE: Approx. 3/4 to 4/5 of the time required by the C200HS.	---	---
	END processing time	0.7 ms (C200HX/HE-CPU□2-E) 2.1 ms (C200HE-CPU11-E)	0.7 ms	2.8 to 3.5 ms
CPU	RS-232C port	C200HX/HG/HE-CPU2□-E/4□-E/6□-E	C200HS-CPU2□-E/3□-E	None
	Clock function	All models except the C200HE-CPU11-E.	All models	Incorporated by the Memory Module
	SYSMAC LINK Module and SYSMAC NET Link Module connection	C200HW-COM01 and C200HW-COM04-E Communications Boards available for connection except the C200HE-CPU11-E.	C200HS-CPU3□-E	C200H-CPU11-E/31-E
Communications Board		The Communications Board can be mounted to all CPUs except the C200HE-CPU11-E. The following are possible with the Communications Board: Use of the SYSMAC LINK Module and SYSMAC NET Link Module expansion of up to 2 communications ports, and use of a protocol macro function	None	None
Interrupts	Interrupt Input Modules	2 (16 points)	1 (8 points)	None
	Interruption with Communications Board	Possible	---	---
	Response time	Same as the C200HS. 1 ms if the C200HW-SLK□□ is used.	C200H-compatible mode: 10 ms C200H mode: 1 ms The C200HS in any mode connected to the SYSMAC LINK Module or SYSMAC NET Link Module 10 ms	---
SYSMAC LINK	Service time	3.5 ms max. (1 system)	10.8 ms max. (1 system)	11.5 ms max. (1 system)
	Remote programming	Via the peripheral port, RS-232C port, and Communications Board	Via the peripheral port only	---
	Influence on interrupt response performance	None	10 ms is required by the C200HS in any mode.	---

User Memory Area

The C200HX, C200HG, and C200HE have a User Memory (UM) area allocation function. This function allows the use of the ladder program area of the UM as a fixed expansion DM area and I/O comment area. The function is enabled with the SYSMAC Support Software (SSS), SYSWIN, or the Programming Console. Only SSS can be used to designate any part of the ladder program area as an I/O comment area (i.e., the Programming Console cannot be used to designate any part of the ladder program area as an I/O comment area).

C200HX/HG/HE Memory Area Structure

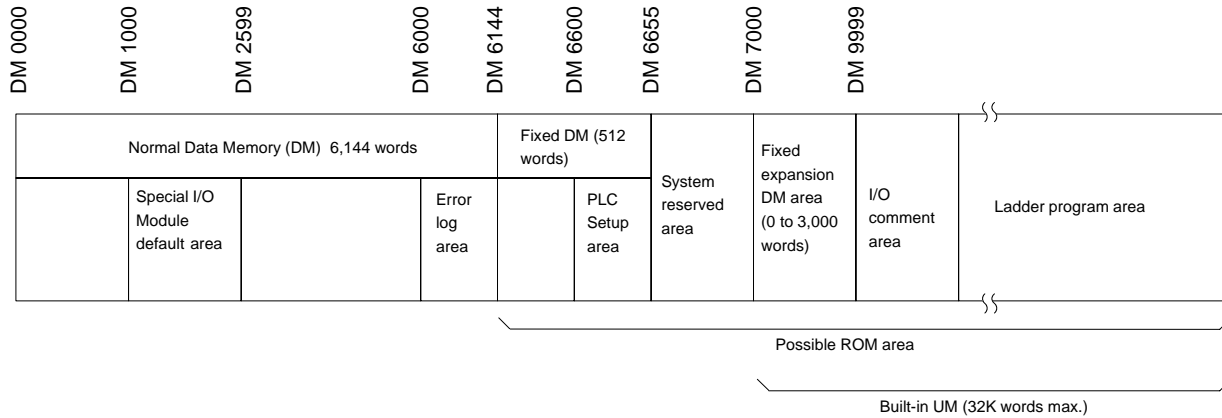

Ladder program area	A user program is stored in the ladder program area. If part of the UM is used as a fixed expansion DM area or I/O comment area, the capacity of the ladder program area storing the user program will be reduced accordingly.
I/O comment area	I/O comments are stored in the I/O comment area. The I/O comments can be stored with a program. The I/O comments can be monitored <i>without</i> loading the comment, just as with conventional comments.
Fixed expansion DM area	The default values of the Special I/O Module, Programmable Terminal, the character string of the Programmable Terminal, and operation data are stored in the fixed expansion DM area. By changing the I/O monitor present value of the Programming Console or using the DM edit transfer operation of the Ladder Support Software, the default values can be written to DM 7000 to DM 9999.
System reserved area	The system reserved area is used by the system only.
PLC Setup area	The settings required for the operation of the PLC are stored in the PLC Setup area.
Normal DM area	The user can freely use the normal DM as a data area for arithmetic operations. If the Special I/O Module is used, DM 1000 to DM 2599 will be a Special I/O Module default area.

- DM 1000 to DM 2599 can be used as a normal DM if DM 7000 to DM 8599 are set as a Special I/O Module default area with the PLC Setup. DM 6000 to DM 6030 are used exclusively as an error log area.
- Unlike the normal DM area, nothing can be written to the fixed expansion DM area using ladder programming.
- The capacity of a ladder program will decrease if the size of the fixed expansion DM area and the total capacity of the I/O comments increase.
- The C200HX, C200HG, and C200HE do not have a fixed expansion DM area or I/O comment area before shipping. The user must allocate these areas in the UM according to the application.

COMMUNICATIONS BOARDS

SPECIFICATIONS, SELECTION GUIDE

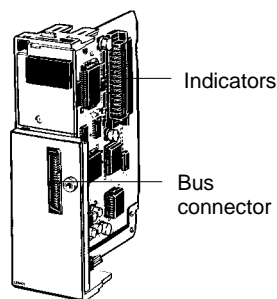

C200HW-COM01

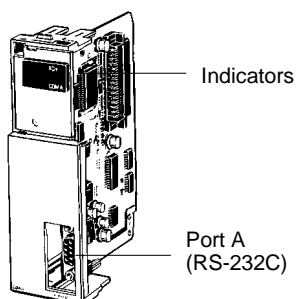

C200HW-COM02

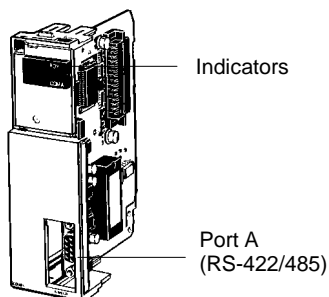

C200HW-COM03

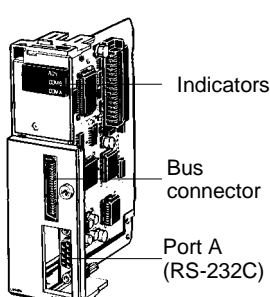

C200HW-COM04-E

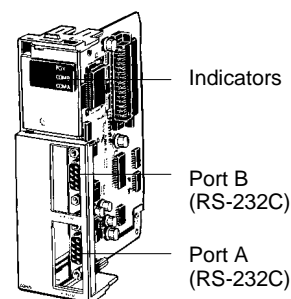

C200HW-COM05-E

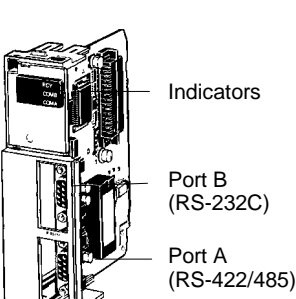

C200HW-COM06-E

The C200H α offers the industry's most versatile PLC communications options. With six Communications Board options, you can select just the right communications for your application. The boards fit into the communications slot in the CPU and let you expand the PLC functionality by connecting to other PLCs or computers with Omron's SYSMAC LINK, SYSMAC NET or, a PC Card Module. A variety of serial ports let you connect to Operator Interfaces, PCs, or other serial communication devices.

Specifications

PART NUMBER	DESCRIPTION
C200HW-COM01	CPU connection when using SYSMAC LINK or SYSMAC NET Link Communications Modules
C200HW-COM02	One RS-232C port
C200HW-COM03	One RS-422/485 port
C200HW-COM04-E	CPU connection for the SYSMAC LINK Module or SYSMAC NET Link Module, and an RS-232C port, with a protocol macro function
C200HW-COM05-E	Two RS-232C ports with a protocol macro function
C200HW-COM06-E	One RS-422/485 port, and one RS-232C port, with a protocol macro function

Communications Board Indicators

INDICATOR	COLOR	STATUS	MEANING	FUNCTION
RDY	Green	Not lit	Board not ready for use	Hardware error
		Flashes	Setting error	System setting or protocol data error
		Lit	Board ready for use	Normal operation
COMB	Orange	Flashes	Communicating	Port B is in use for communication
COMA				Port A is in use for communication

Note: Order the Communications Board and Memory Cassette separately (not provided with the CPU).

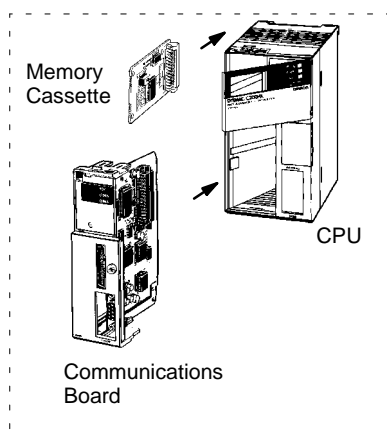

COMMUNICATION BOARDS

PROTOCOL MACRO

The Protocol Macro instruction permits easy interfacing of C200H α CPUs with peripheral devices. In cases where ASCII/BASIC Modules have been used to interface with peripheral devices, the Protocol Macro instruction now offers an extremely automated method. The Protocol Macro instruction is a communications protocol that controls data transfer using various devices and components equipped with RS-232C or RS-422/485 ports – thus, replacing ASCII/BASIC Modules and the difficult associated programming procedures. The C200H α Communications Boards COM04-E, COM05-E, and COM06-E have a built-in Protocol Macro capability, providing seven Omron communications protocols. The data transfer procedures may be modified with Omron's Protocol Support Software. Communications sequences are executed from the ladder program with the Protocol Macro Instruction (PMCR).

Features

The C200H α Communications Boards COM04-E, COM05-E, and COM06-E (with protocol macro capability built-in) offer these seven standard communications sequences:

1. Temperature Controller Sequence E5□J, E5□K, ES100□, and E5ZE
2. Intelligent Signal Processor Sequence K3TH, K3TR, K3TX, and K3TC
3. Bar Code Reader Sequence V500 and V520
4. Laser Micrometer Sequence 3Z4L
5. Visual Inspection System Sequence F200, F300, and F350
6. ID Controller Sequence V600
7. Hayes AT Command (Modem) Sequence ME 1414BZ, MD 24FB10V, and MD 144FB5V

Or, use the Protocol Support Software to create Communications sequences other than those listed.

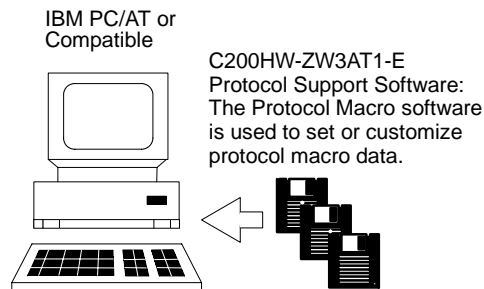

C200HX/HG/HE
C200HW-COM04-E/05-E/06-E Communications Board
(with protocol macro function)

RS-232C

Standard measuring devices,
components, and personal
computers

Asynchronous (start-stop synchronization) communication

OMRON's peripheral devices (equipped with standard communications sequences)

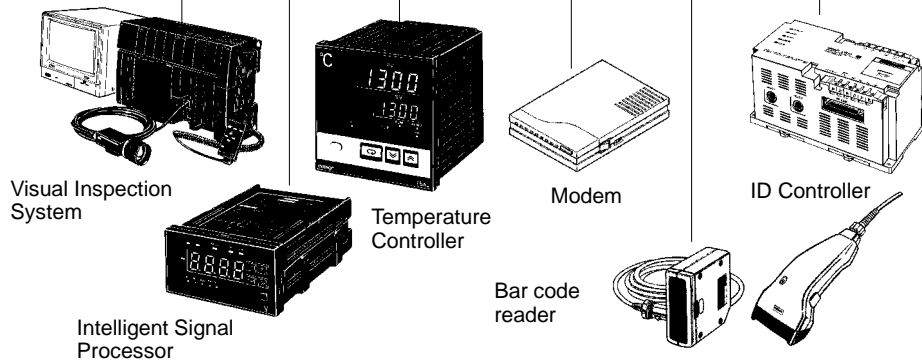

COMMUNICATION BOARDS

PROTOCOL MACRO

System Configuration Examples

RS-232C (C200HW-COM05-E)

An RS-232C line connects the C200HW-COM05-E and a device, allowing the RS-232C line to be a maximum of 15 m.

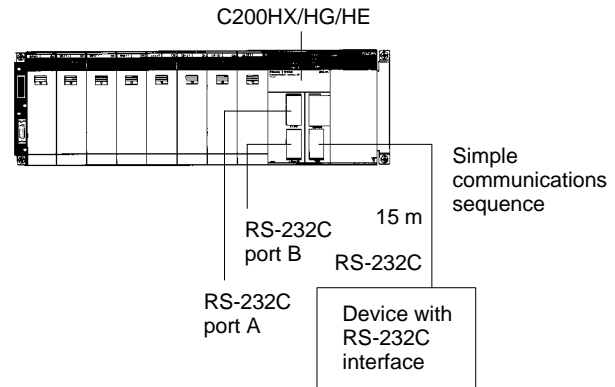

RS-422/485 (C200HW-COM06-E)

The C200HW-COM06-E connects to one or more devices through the RS-422 and RS-485 port provided the RS-422 or RS-485 line between the C200HW-COM06-E and the farthest device is a maximum of 500 m.

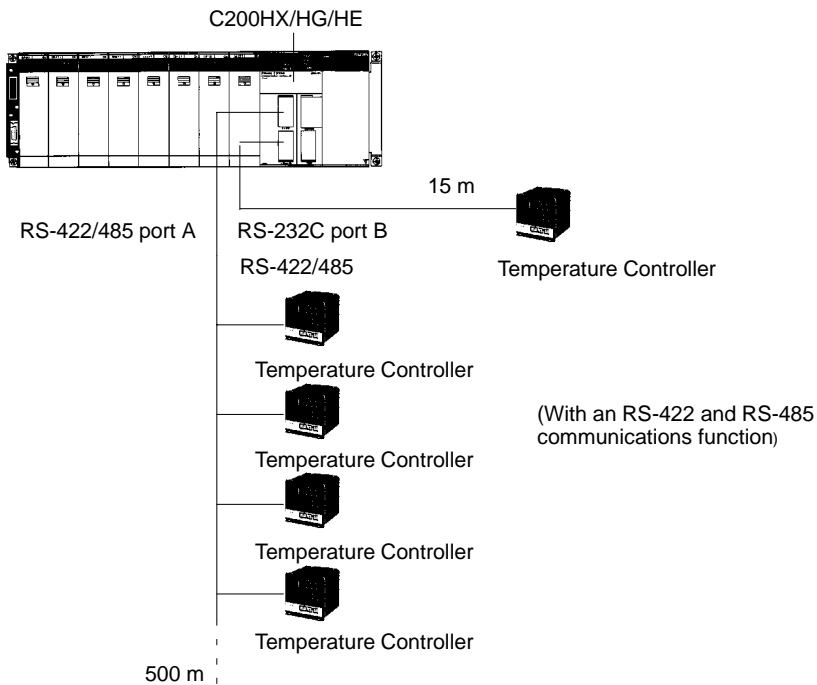

MEMORY CASSETTES

SPECIFICATIONS

**EEPROM or EPROM
Memory Cassettes**

Each C200H α CPU can accept a Memory Cassette to provide back-up or downloading of programs and data. EEPROM models allow the program to be downloaded to and from the CPU memory. EPROM models allow the user to write to an EPROM and insert it into the memory cassette.

**EEPROM Memory Cassette –
No Back-up Power Supply Required**

The EEPROM Memory Cassette can be installed in the C200HX, C200HG, and C200HE CPUs to write and read programs and I/O data to the CPU.

Because the EEPROM Memory Cassette does not require any backup power supply, it will retain its data even after it is disconnected from the CPU.

EEPROM Memory Cassette Capacity

CAPACITY	PART NUMBER
4K words	C200HW-ME04K
8K words	C200HW-ME08K
16K words	C200HW-ME16K
32K words	C200HW-ME32K

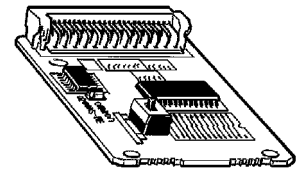

**EEPROM
Memory Cassette**

**EPROM Memory Cassette –
Use a Standard PROM Writer to Write a Program**

Connect an EPROM to the EPROM Memory Cassette before installing the EPROM Memory Cassette into the CPU.

An EPROM Memory Cassette will lose its data if it is disconnected from the CPU.

EPROM Memory Cassette Capacity

DESCRIPTION	CAPACITY	PART NUMBER
Cassette	16K words/32K words	C200HS-MP16K
EPROM (Order ROM Separately)	Equivalent to 27256	ROM-JD-B
	Equivalent to 27512	ROM-KD-B

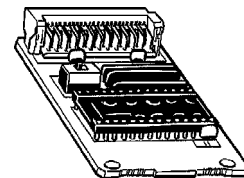

**EPROM
Memory Cassette**

POWER SUPPLY MODULES

CAPACITIES AND SPECIFICATIONS

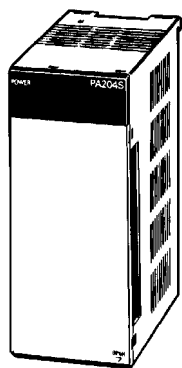

C200HW-P□□□

All CPU Racks and Expansion Racks feature separate Power Supplies that may be replaced individually to meet system requirements without having to replace the other components. The Power Supply provides power for the CPU and Modules on the Rack. Choose an AC or DC version. Model C200HW-PA204S comes with built-in 24 VDC Power Supply that may be used to power Special I/O Modules, Sensors, or other devices, eliminating the need for a separate Power Supply.

Power Supply Modules Available

SUPPLY VOLTAGE	COMMENTS	PART NUMBER
100 to 120 VAC 200 to 240 VAC	---	C200HW-PA204
	With 24-VDC service power supply	C200HW-PA204S
24 VDC	---	C200HW-PD024

Select the Appropriate Backplane for the CPU with its I/O Modules

When selecting Backplanes for the CPU, the Expansion I/O, and the Slave Rack(s), each type of Backplane is a different model number. To order, refer to the specific information provided separately in the *Standard Parts* section of this catalog.

Dimensions

**CPU I/O Backplane
C200HW-BC□□□**

Unit: mm (inch)

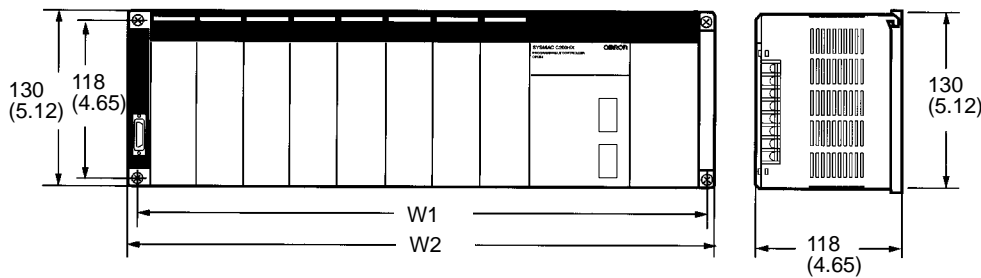

NO. OF SLOTS	W1	W2	PART NUMBER
3 slots	246 (9.69)	260 (10.24)	C200HW-BC031
5 slots	316 (12.44)	330 (12.99)	C200HW-BC051
8 slots	421 (16.57)	435 (17.13)	C200HW-BC081
10 slots	491 (19.33)	505 (19.88)	C200HW-BC101

**Expansion I/O Backplane
C200HW-BI□□□**

Unit: mm (inch)

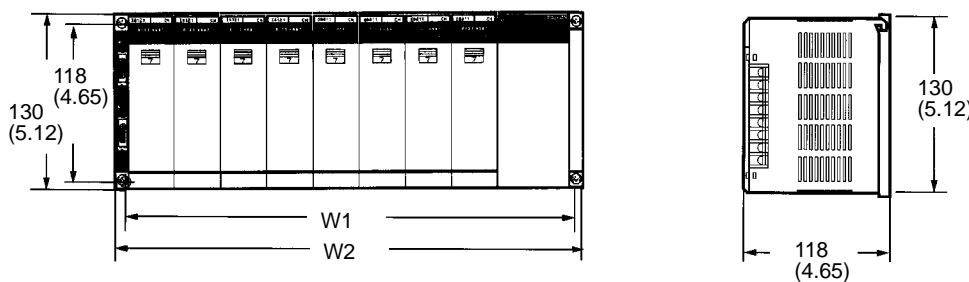

NO. OF SLOTS	W1	W2	PART NUMBER
3 slots	175 (6.89)	189 (7.44)	C200HW-BI031
5 slots	245 (9.65)	259 (10.20)	C200HW-BI051
8 slots	350 (13.78)	364 (14.33)	C200HW-BI081
10 slots	420 (16.54)	434 (17.09)	C200HW-BI101

BACKPLANES

SPECIFICATIONS

Slave Rack Backplane C200H-BC□□□-V2

Unit: mm (inch)

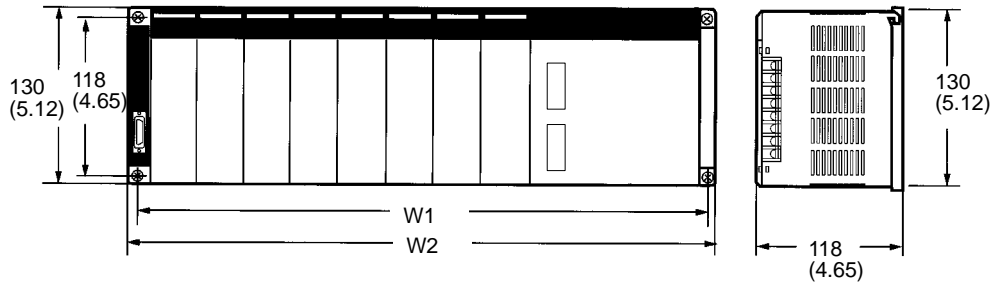

NO. OF SLOTS	W1	W2	PART NUMBER
3 slots	246 (9.69)	260 (10.24)	C200H-BC031-V2
5 slots	316 (12.44)	330 (12.99)	C200H-BC051-V2
8 slots	421 (16.57)	435 (17.13)	C200H-BC081-V2
10 slots	491 (19.33)	505 (19.88)	C200H-BC101-V2

CONNECTING I/O CABLES
 FEATURES, CAPACITIES AND SPECIFICATIONS

I/O Connecting Cables connect a CPU Rack to an Expansion I/O Rack or an Expansion I/O Rack to another Expansion I/O Rack. The following five types of I/O Connecting Cables are available. The total length of the I/O Connecting Cables used in a configuration must be 12 m maximum.

Note: Count the Expansion I/O Racks (connected in this way) against the maximum of five Slave Racks that can be connected.

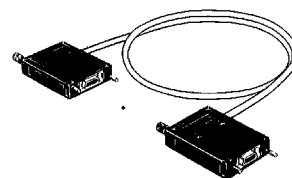

I/O Connecting Cables

Select from Five I/O Connecting Cables

CABLE LENGTH (CM)	PART NUMBER
30	C200H-CN311
70	C200H-CN711
200	C200H-CN221
500	C200H-CN521
1,000	C200H-CN131

Note: The total length of the I/O Connecting Cables used in a network must not exceed 12 m.

DISCRETE I/O MODULES

OVERVIEW

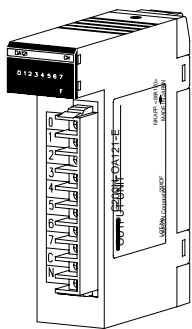

Connector Style A

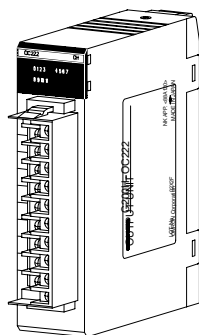

Connector Style B

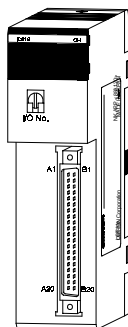

Connector Style C

Discrete I/O modules are available in a number of voltages, densities, terminal block, and connector types. Connector-style high-density I/O modules with 32 or 64 discrete I/O points per module have solder connectors included with the module. Optional wiring methods are available using Omron's I/O blocks, screw terminal, crimp and ribbon connectors, and pre-terminated cables. These versatile high-density configuration options minimize rack space and wiring time. The Omron I/O Blocks provide single-point isolation and up to 5 A current capacity per point. Replaceable relays and solid-state plug-in modules allow easy maintenance. There are five styles of discrete I/O modules in the C200H family. The profiles of each are shown here. Each module in the following pages is cross-referenced to the module style. Modules include the appropriate connectors.

Features

- Versatile high-density configuration options minimize rack space and wiring time
- Replaceable relays and solid-state plug-in modules mean easy maintenance

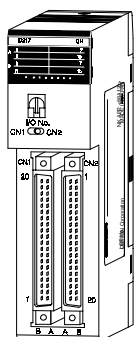

Connector Style D



Connector Style E

Discrete I/O Modules – Varying Connector Types

Input Module Specifications

TYPE	NO. OF INPUTS	INPUTS PER COMMON	INPUT VOLTAGE	INPUT CURRENT	OPERATING VOLTAGE		INPUT RESPONSE TIME		MODULE-STYLE	PART NUMBER
					ON	OFF	ON	OFF		
AC Input	8 pts.	8 pts.	100 to 120 VAC +10%/-15%	10 mA, 100 VAC	60 VAC min.	20 VAC max.	35 ms max.	55 ms max.	A	C200H-IA121
	16 pts.	16 pts.							B	C200H-IA122
	8 pts.	8 pts.	200 to 240 VAC +10%/-15%	10 mA, 200 VAC	120 VAC min.	40 VAC max.			A	C200H-IA221
	16 pts.	16 pts.							B	C200H-IA222
DC Input	8 pts.	8 pts.	12 to 24 VDC +10%/-15%	10 mA, 24 VDC	10.2 VDC min.	3.0 VDC max.	1.5 ms max.	1.5 ms max.	A	C200H-ID211
	16 pts.	16 pts.	24 VDC +10%/-15%	7 mA, 24 VDC	14.4 VDC min.	5.0 VDC max.			B	C200H-ID212
AC/DC Input	8 pts.	8 pts.	12 to 24 VAC/DC +10%/-15%	10 mA, 24 VDC	10.2 VDC min.	3.0 VDC max.	15 ms max.	15 ms max.	A	C200H-IM211
	16 pts.	16 pts.	24 VAC/DC +10%/-15%	7 mA, 24 VAC/ DC	14.4 VDC min.	5.0 VDC max.			B	C200H-IM212

- Note:**
1. All models feature photocoupler isolation and LED indicator.
 2. Each Discrete I/O Module has a removable terminal block. See the above *STYLE* column for a reference to the module style/connector type and refer to the accompanying drawing and chart for specific connector details.

Input Module Circuit Configuration

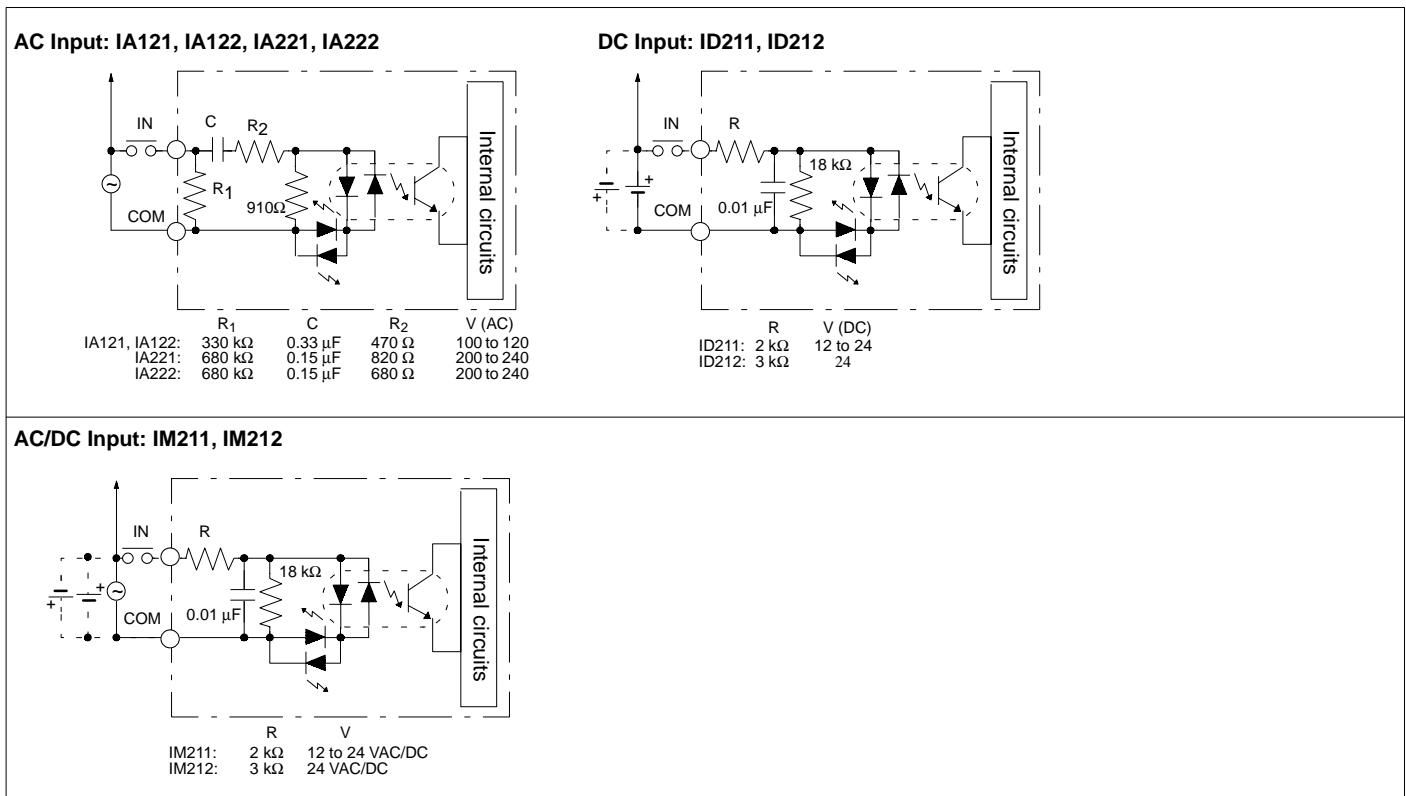

DISCRETE I/O MODULES

OUTPUT MODULE SPECIFICATIONS

Output Module Specifications

No. of outputs	Rated load voltage	Max. load current	Min. switching capacity	Output response times		Leakage current	Outputs/ per common	Fuse	External power supply	Internal power consumption (VDC)	Part number	
				ON	OFF							
Relay Output												
8 pts.	250 VAC (cos ϕ = 1)/ 250 VAC (cos ϕ = 0.4)/ 24 VDC max.	2 A/pt. 8 A/8 pts.	10 mA, 5 VDC	10 ms max.	10 ms max.	---	8 pts.	---	---	10 mA max.	C200H-OC221	
12 pts.		2 A/pt. 8 A/ 12 pts.					12 pts.				C200H-OC222 (see note)	
16 pts.		2 A/pt. 8 A/ 16 pts.					16 pts.				50 mA max. C200H-OC225 (see note)	
5 pts.		2 A/pt. 10 A/5 pts.					1 pt.				10 mA max. C200H-OC223	
8 pts.		2 A pts. 16 A/8 pts.									C200H-OC224	
Triac Output												
8 pts.	120 VAC	1 A/pt. 4 A/8 pts.	Resistive load: 10 mA; inductive load: 40 mA (10 VAC)	1 ms max.	1/2 of load fre- quen- cy max.	3 mA max., 100 VAC; 6 mA max., 200 VAC	8 pts.	5 A		140 mA max.	C200H-OA121-E	
12 pts.	250 VAC, 50/60 Hz	0.3 A/pt. 2 A/12 pts.		1/2 of load fre- quen- cy max.				12 pts.		3 A		200 mA max.
8 pts.		1.2 A/pt. 4 A/8 pts.	Resistive load: 100 mA; inductive load: 50 mA (10 VAC)	1 ms max.		8 pts.	5 A		180 mA max.	C200H-OA223		
12 pts.		0.5 A/pt. 2 A/12 pts.	100 mA, 10 VAC; 50 mA, 24 VAC; 100 mA, 100 VAC	1/2 + 1 ms of load fre- quen- cy max.	1.5 mA max., 120 VAC; 3 mA max., 240 VAC	12 pts.	3.15 A		270 mA max.	C200H-OA224		
Transistor Output												
8 pts.	12 to 48 VDC +10%/-15%	1 A/pt. 3 A/8 pts.	Residual voltage: 1.4 V max.	0.2 ms max.	0.3 ms max.	0.1 mA max.	8 pts.	5 A	30 mA, 12 to 48 VDC min.	140 mA max.	C200H-OD411	
	24 VDC +10%/-15%	2.1 A/pt. 5.2 A/8 pts.										
		0.8 A/pt. 2.4 A/8 pts.	Residual voltage: 1.5 V max.	1 ms max.	1 ms max.	1 mA max.					None	150 mA, 24 VDC min.
	5 to 24 VDC	0.3 A/pt.	10 mA, 5 VDC	1.5 ms max.	2 ms max.	0.1 mA max.					5 to 24 VDC	10 mA max.
12 pts.	24 VDC +10%/-15%	0.3 A/pt. 2A/12 pts.	Residual voltage: 1.4 V max.	0.2 ms max.	0.3 ms max.		12 pts.	5 A	25 mA, 24 VDC min.	160 mA max.	C200H-OD211	
16 pts.		0.3 A/pt. 4.8 A/12 pts.								16 pts.	8 A	35 mA, 24 VDC min.
12 pts.	5 to 24 VDC	0.3 A/pt.	10 mA, 5 VDC	1.5 ms max.	2 ms max.		12 pts.	None	5 to 24 VDC	10 mA max.	C200H-OD217	
16 pts.	24 VDC +10%/-15%	1 A/pt. 4 A/16 pts.	Residual voltage: 0.8 V max.	0.1 ms max.	0.3 ms max.		16 pts.		35 mA, 24 VDC min.	160 mA max.	C200H-OD21A	

Note: Do not exceed the load current of 8 A per common. No more than 8 outputs can be turned ON simultaneously.

Output Module Circuit Configuration

Relay Output: OC221, OC222, OC223, OC224, OC225

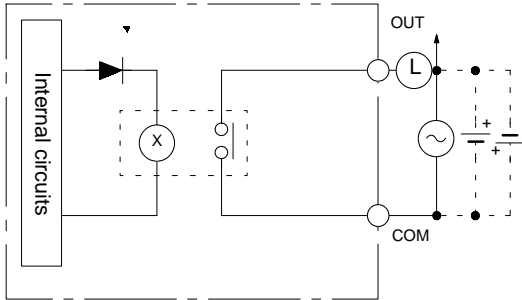

Use either + or - VDC

Triac Output: OA222V, OA121-E

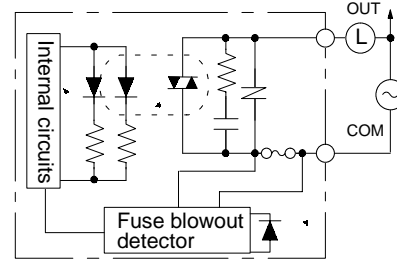

OA222V: no fuse blowout detector

Triac Output: OA223, OA224

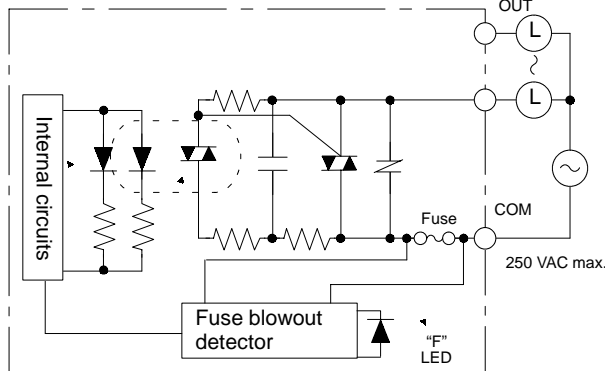

OA224: no fuse blowout detector

Transistor Output: OD411/OD211

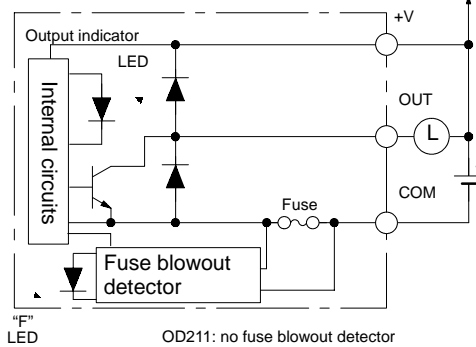

OD211: no fuse blowout detector

Transistor Output: OD213/OD212

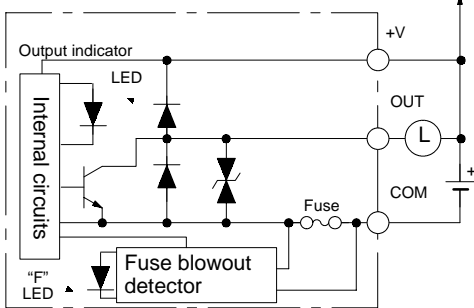

OD212: No fuse blowout detector

Transistor Output (Source Type): OD214

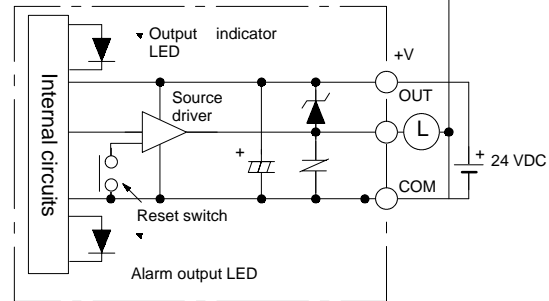

Transistor Output (Protective Circuit for Load Short-circuit): OD216/OD217

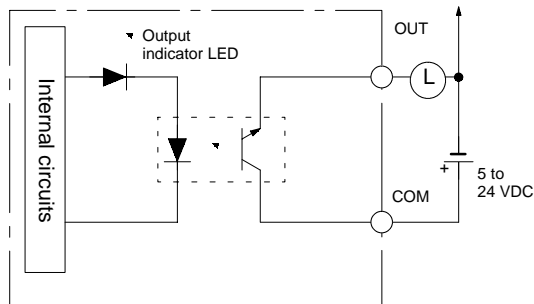

Transistor Output (Source Type with Protective Circuit for Load Short-circuit): OD21A

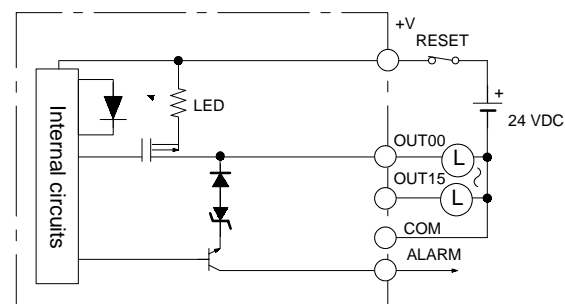

Note: Fuse blowout detection circuit: The F indicator is lit and the 08 bit turns ON. The 08 to 15 bits cannot be used as ordinary IR bits.

SPECIAL I/O MODULES

B7A INTERFACE MODULES

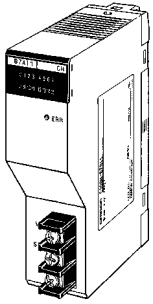

C200H-B7A11
(16 Input Points)

C200H-B7A01
(16 Output Points)

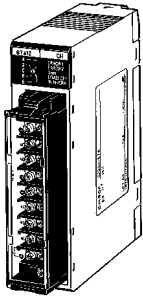

C200H-B7A12
(32 Input Points)

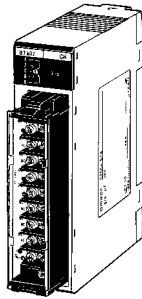

C200H-B7A02
(32 Output Points)

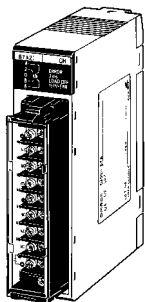

C200H-B7A21
(16 Input and
16 Output Points)

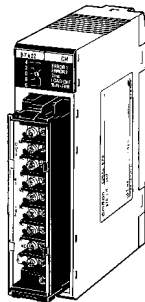

C200H-B7A22
(32 Input and
32 Output Points)

The C200H-B7A Interface Modules reduce wiring from 16 input devices or 16 output devices to a few wires. The B7A allows you to remotely connect I/O that would have required direct connection to the PLC. You save control panel space, wiring time, and man-hours required for installation. These modules can be used with the full range of B7A input and output blocks for 16 I/O. The modules require a power supply, as do the terminal blocks.

Features

- Connect directly to the B7A I/O blocks using a two-conductor wire
- Transmission distance up to 500 m max.

SPECIAL I/O MODULES

B7A INTERFACE MODULES

System Configuration

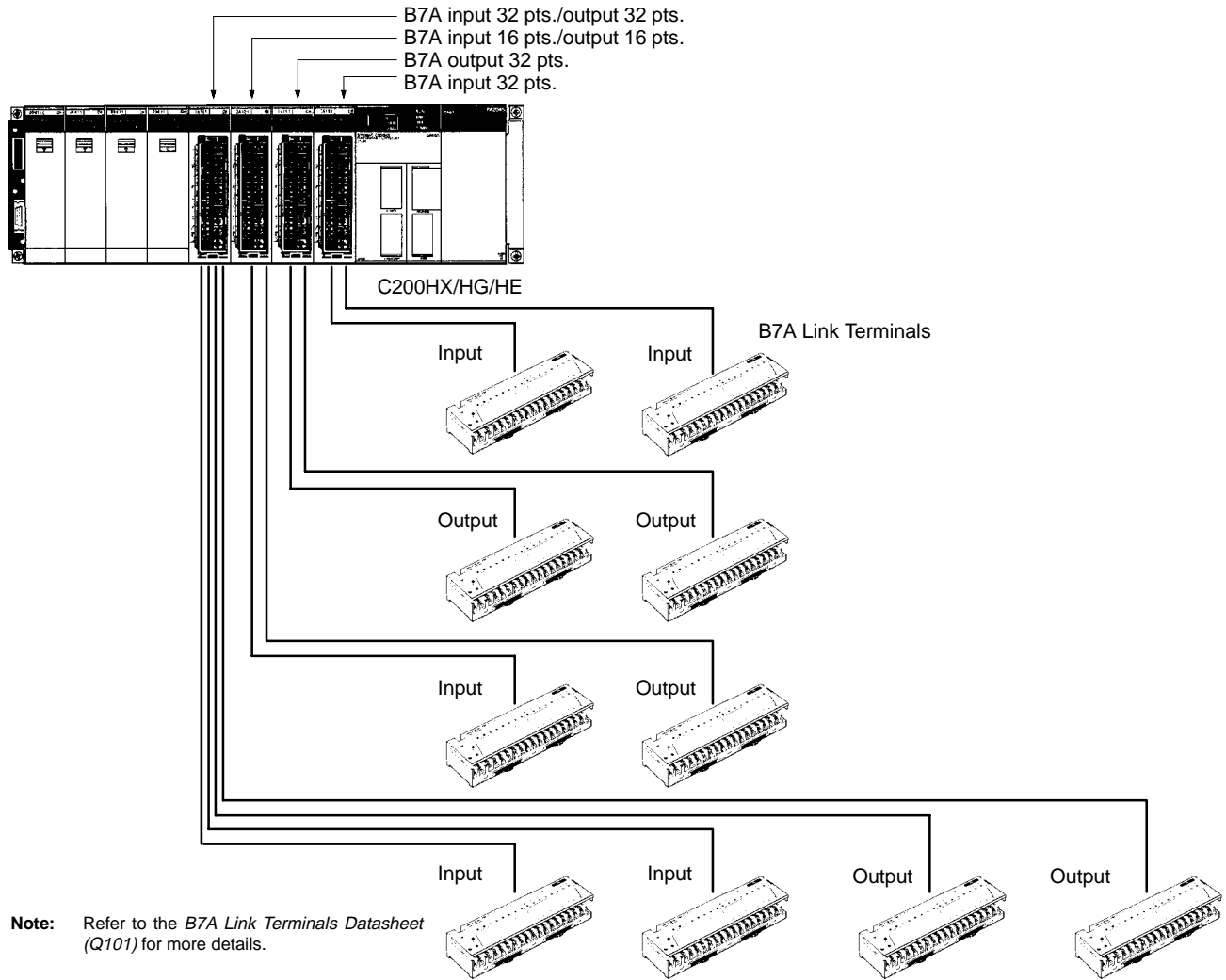

Note: Refer to the *B7A Link Terminals Datasheet (Q101)* for more details.

SPECIAL I/O MODULES

B7A INTERFACE MODULE

Performance Specifications

PART NUMBER	C200H-B7A11	C200H-B7A01	C200H-B7A12	C200H-B7A02	C200H-B7A21	C200H-B7A22
	B7A INTERFACE MODULES		GROUP-2 B7A INTERFACE MODULES			
I/O points	16 points or 15 points and 1 error input	16 output points	32 input points or 30 input points and 2 error inputs	32 output points	16 output points and 16 input points or 15 input points + 1 error input	32 output points and 32 input points or 30 input points + 2 error inputs
Transmission distance	500 m max. if power is supplied to the Interface Module and B7A Link Terminal separately. 100 m max. if power is supplied to the Interface Module and B7A Link Terminal from a single power supply.		Standard: 500 m max. using separate power supplies. 100 m max. using a common power supply. High-speed: 100 m max. using separate power supplies. 50 m max. using a common power supply. If shielded cable is not used, the maximum transmission distance is 10 m regardless of whether a common or separate power supplies are used.			
Transmission delay	19.2 ms typical, 31 ms max.		Standard: 19.2 ms typical, 31 ms max. High-speed: 3 ms typical, 5 ms max. (see note 1)			
Internal current consumption	5 VDC, 100 mA max.					
External power supply (see note 2)	12 to 24 VDC \pm 10%					
	0.01 A min.	0.03 A min.	0.05 A min.	0.06 A min.	0.05 A min.	0.08 A min.
Weight	200 g max.		300 g max.			
Word allocations	Same as I/O Modules (in order mounted).		The words allocated to Group-2 B7A Interface Modules are determined by I/O number set on the Modules. Words 030 to 049 allocated according to I/O number setting. Modules with 32 I/O points are allocated two words; Modules with 64 I/O points are allocated four words.			

- Note:**
1. The transmission delay is changed by using the DIP switch.
 2. The value of the external power supply does not include the value required by the B7A Link Terminal.

Connectable B7A Link Terminals

Input Terminals

TYPE	TRANSMISSION DELAY	PART NUMBER
Screw terminals	Standard (19.2 ms)	B7A-T6□1
		B7AS-T6□1
	High-speed (3 ms)	B7A-T6□6
		B7AS-T6□6
Modular	Standard (19.2 ms)	B7A-T6D2
	High-speed (3 ms)	B7A-T6D7
PLC connectors	Standard (19.2 ms)	B7A-T□E3
	High-speed (3 ms)	B7A-T□E8

Output Terminals

TYPE	TRANSMISSION DELAY	PART NUMBER
Screw terminals	Standard (19.2 ms)	B7A-R6□□1
		B7AS-R6□□1
	High-speed (3 ms)	B7A-R6□□6
		B7AS-R6□□6
Modular	Standard (19.2 ms)	B7A-R6A52
	High-speed (3 ms)	B7A-R6A57
PLC connectors	Standard (19.2 ms)	B7A-R□A□3
	High-speed (3 ms)	B7A-R□A□8

SPECIAL I/O MODULES

HIGH-DENSITY INPUT MODULE SPECIFICATIONS (GROUP-2)

The High-density Input Modules let you pack more input points into a single I/O slot for greater space savings. These modules do not use standard I/O points. Thus, they increase the overall I/O capacity. They provide 32 or 64 discrete input points. The modules can be used with Omron's Terminal Blocks, reducing wiring between control panels, as well as within control panels.

Features

- Easy cable connection to Omron's XW2B-□ Terminal Blocks using XW2Z-□ Connecting Cable. Refer to the *Standard Parts* section for detailed ordering information.
- Up to ten 64-point modules or 32-point modules per PLC

Note: The ambient temperature affects the number of points that can be ON simultaneously.

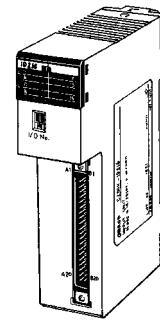

C200H-ID216
(32 DC input pts.)

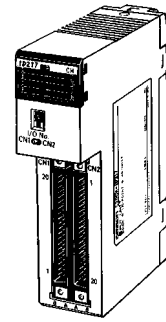

C200H-ID217
(64 DC input pts.)

Specifications

PART NUMBER	C200H-ID216	C200H-ID217
Number of inputs	32 points	64 points
Rated input voltage	24 VDC +10%/−15%	
Input current	4.1 mA typical at 24 VDC	
Input impedance	5.6 k Ω	
ON voltage	14.4 VDC min.	
OFF voltage	5.0 VDC max.	
Input ON delay	1.0 ms max.	
Input OFF delay	1.0 ms max.	
Isolation	Photocoupler	
Input indicator	LED	
External connections	Connector	
Number of circuits (see note)	32 points with one common	64 points with two commons
Internal power consumption	100 mA max. at 5 VDC	120 mA max. at 5 VDC
Weight	180 g max.	250 g max.
Manual	W302	

Circuit Configuration

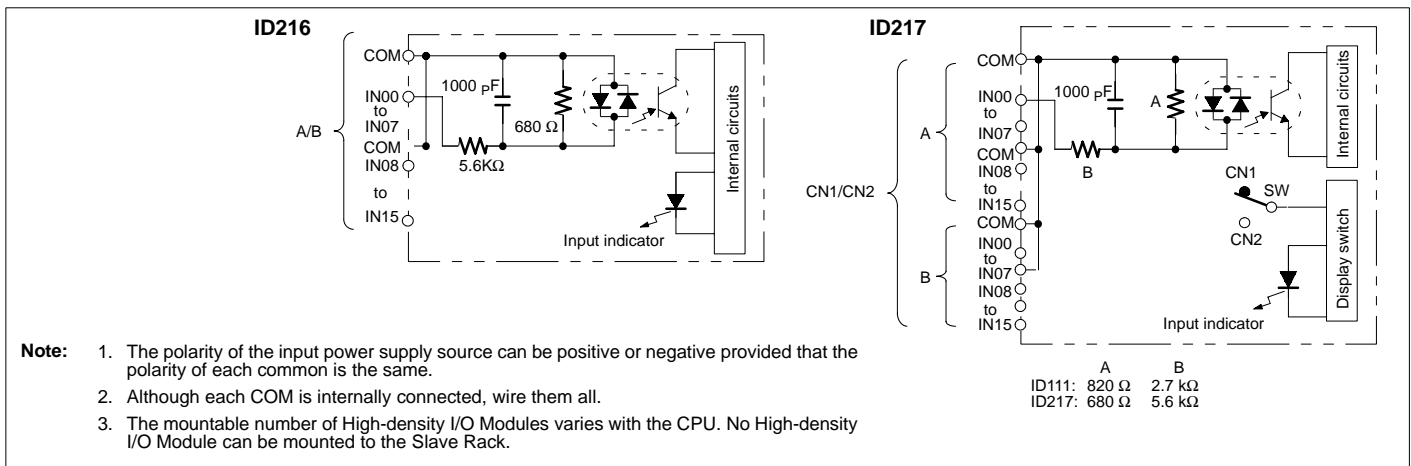

SPECIAL I/O MODULES

HIGH-DENSITY OUTPUT MODULE SPECIFICATIONS (GROUP-2)

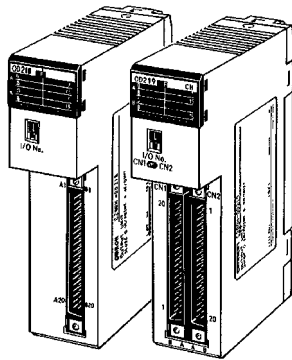

C200H-OD218
(32 DC output pts.)

C200H-OD219
(64 DC output pts.)

Using the High-density Output Modules, you pack more output points into a single I/O slot for greater space savings. These modules increase the overall I/O capacity, while not using standard I/O points. They provide 32 or 64 discrete output points. The modules can be used with Omron's Terminal Blocks and Cables, reducing wiring between control panels, as well as within control panels.

Features

- Easy cable connection to Omron's XW2B-□ Terminal Blocks using XW2Z-□ Connecting Cable. Refer to the *Standard Parts* section for detailed ordering information.
- Up to ten 64-point modules or 32-point modules per PLC

Specifications

PART NUMBER	C200H-OD218	C200H-OD219
Number of outputs	32 points	64 points
Max. switching capacity	16 mA at 4.5 V to 100 mA at 26.4 V	
Leakage current	0.1 mA max.	
Residual voltage	0.8 V max.	
Input ON delay	0.1 ms max.	
Input OFF delay	0.4 ms max.	
Output indicator	LED	
External connections	Connector	
Number of circuits	32 points with one common	64 points with two commons
Fuse (see note)	3.5 A (one/common)	
External power supply	110 mA (3.4 mA per ON pt) min. at 5 to 24 VDC $\pm 10\%$	220 mA (3.4 mA per ON pt) min. at 5 to 24 VDC $\pm 10\%$
Internal power consumption	180 mA max. at 5 VDC	260 mA max. at 5 VDC
Manual	W302	

Note: The fuse is not user replaceable.

Circuit Configuration

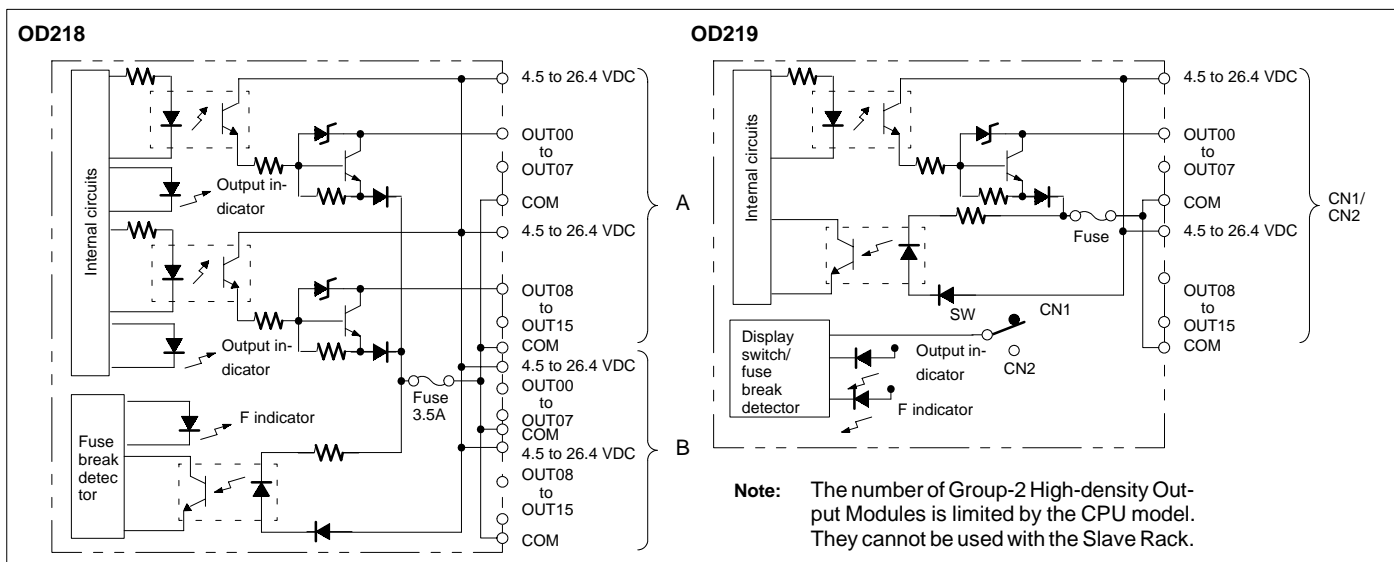

Note: The number of Group-2 High-density Output Modules is limited by the CPU model. They cannot be used with the Slave Rack.

SPECIAL I/O MODULES

ANALOG TIMER MODULE

The Analog Timer Module lets the user fine-tune timer values manually, without going into the PLC program. Adjustments can be made from the front part of the module or from remote locations (using a special cable and external variable resistors). The module has four independently set and monitored timers that each have variable ranges. The user may select, by DIP switch, for each point to use front panel variable resistor or external variable resistors. Through internal bit allocation, each timer can be started and paused, allowing for them to be used as cumulative timers.

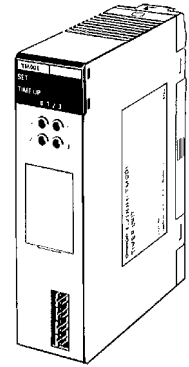

C200H-TM001

Features

- Four front panel variable resistors are used to set the timers
- Connecting Cable No. C4K-CN233 available for external variable resistors
- Indicators show operation and time-up status
- Cumulative timer available using pause bits
- Timer values may be adjusted without program changes

Specifications

PART NUMBER	C200H-TM001
Timing method	CR oscillator
No. of timers	4
Setting ranges	0.1 to 1.0 s, 1 to 10 s, 10 to 60 s, 1 to 10 min
Operation	Controllable from PLC program. Usable as accumulating timer.
External adjustment	Via C4K-CN223 (2 m) connector to 20-k Ω resistor
Manual	W302

System Configuration

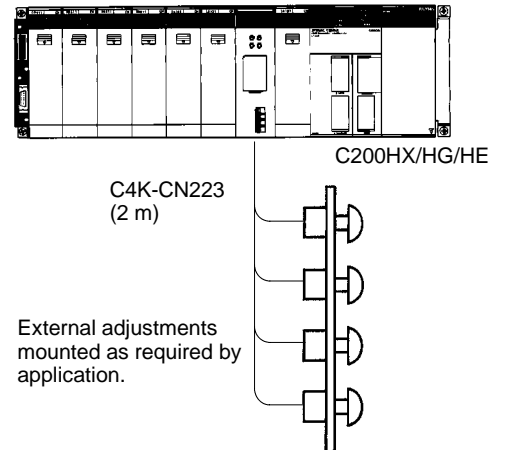

SPECIAL I/O MODULES

INTERRUPT INPUT MODULE

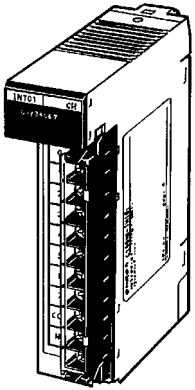

C200HS-INT01

The Interrupt Input Module allows real world discrete inputs to interrupt the scan of the main ladder logic program and execute specific interrupt ladder logic. For systems requiring immediate response and fast throughput from field input signals, the Interrupt Input Module can provide fast sub-scan execution and response times. The Module can be configured to provide immediate interrupts and scheduled interrupts which repeat execution on a preset time base. Interrupts can also be configured to interrupt currently executing interrupt logic.

Features

- Using input interrupts, the Interrupt Input Module temporarily interrupts the main program to execute interrupt subroutines
- High-speed immediate or scheduled logic execution
- Provides sub-scan response to field input signals
- Ladder instructions control and monitor interrupt inputs

Specifications

PART NUMBER	C200HS-INT01
Rated Input Voltage	12 to 24 VDC $+10\%/_{-15\%}$
Input Impedance	2 K Ω
Input Current	10 mA typical (24 VDC)
ON Voltage	10.2 VDC min.
OFF Voltage	3.0 VDC max.
ON Response Time	0.2 ms max.
OFF Response Time	0.5 ms max.
No. of Circuits	1 (8 points/common)
Internal Current Consumption	20 mA, 5 VDC max.
Weight	200 g max.
Manual	W302

Note: The Interrupt Input Module must be mounted on the CPU Rack. Only two Interrupt Input Modules can be mounted per CPU Rack.

SPECIAL I/O MODULES

INTERRUPT INPUT MODULE

Interrupt Input Operation

The above application shows input bits IR 00400 through IR 00407 assigned to subroutines 00 to 07. For example, when the input for IR 00400 goes ON, normal program execution is interrupted and the subroutine between SBN 000 and RET is executed. If required, outputs can be refreshed immediately by programming the I/O REFRESH instruction within the subroutine.

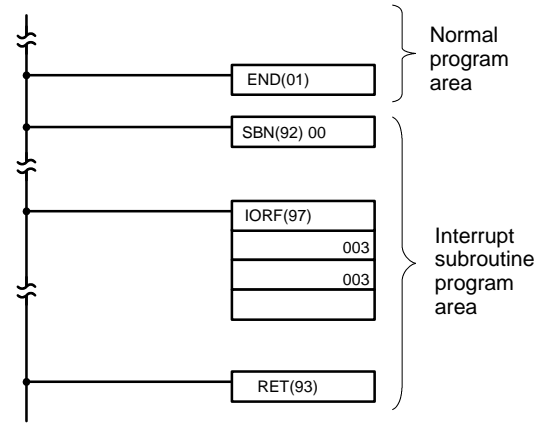
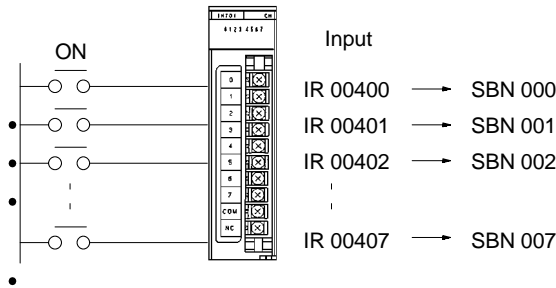

Only the word 003 output processed in the interrupt subroutine program is immediately refreshed.

Note: If the Interrupt Input Module is mounted on an Expansion I/O Rack, the interrupt function cannot be used, and the Interrupt Input Module will be treated as an ordinary 8-point Input Module. Interrupt Input Modules cannot be used on Slave Racks.

Circuit Configuration

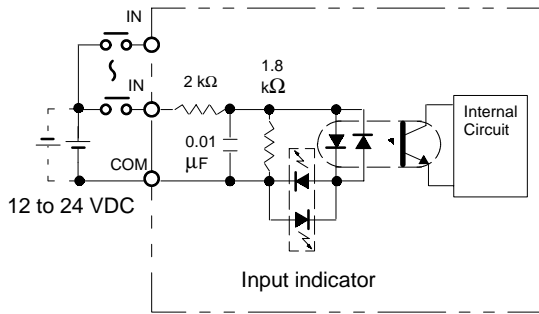

The polarity of the input power supply source can be positive or negative provided that the polarity of each common is the same.

SPECIAL I/O MODULES

HIGH-DENSITY INPUT MODULE

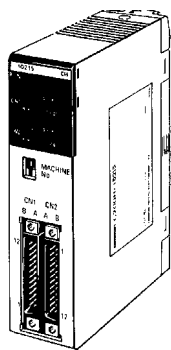

C200H-ID215 (DC input)
C200H-ID501 (TTL input)

The High-density Input Modules let you pack more input points into a single I/O slot for greater space savings. Functioning as Special I/O modules, they do not use standard I/O points. Thus, they increase the overall I/O capacity. They provide 32 discrete input points with selectable response times of 2.5 ms or 15 ms. For even shorter signals, 8 inputs can be designated as quick-response inputs, to receive selectable 1 ms or 4 ms signals. The modules can also be used with Omron's Terminal Blocks, reducing wiring between control panels as well as within control panels.

Features

- 8 quick-response inputs available to receive short signals
- Easy cable connection to Omron's XW2B-□ Terminal Blocks using XW2Z-□ Connecting Cable. Refer to the *Standard Parts* section for detailed ordering information.
- Selectable input response time
- LED indicator
- Provides a photocoupler for isolation

Specifications

PART NUMBER	C200H-ID215	C200H-ID501
MODULE NAME	DC INPUT MODULE	TTL INPUT MODULE
No. of inputs	32	
Input voltage and input current	24 VDC $\pm 10\%$ –15% 4.1 mA, 24 VDC	5 VDC $\pm 10\%$; 3.5 mA, 5 VDC
Operating voltages	ON: 14.4 VDC min. OFF: 5.0 VDC max.	ON: 3.0 VDC min. OFF: 1.0 VDC max.
Output response times	ON: 2.5/1.5 ms (selectable) OFF: 2.5/15 ms (selectable)	
Inputs per common	8 pts (4 circuits)	
Internal current consumption	130 mA max. (5VDC)	
Manual	W302	

Note: High-density Modules are equipped with quick-response functions and have Special I/O functions. When mounting these models to a SYSMAC BUS Slave, the Remote I/O Master must be the C200H-RM001-PV1 or C200H-RM201.

SPECIAL I/O MODULES

HIGH-DENSITY INPUT MODULE

Circuit Configuration

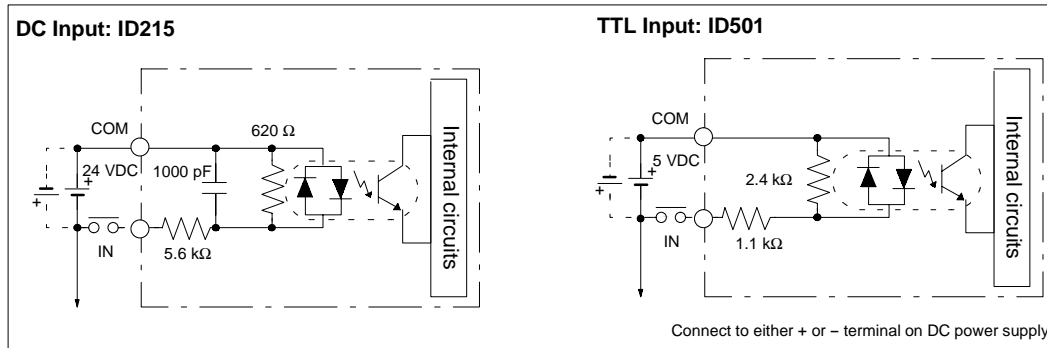

I/O Refresh Instruction

The I/O Refresh instruction, IORF(97), can be used with the quick-response input function to read the input status held in the quick-response input buffer whenever needed in a program.

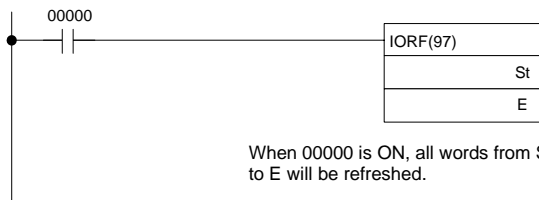

When 00000 is ON, all words from St to E will be refreshed.

St and E would be 101 for Unit #0, making bits IR 10108 to IR 10115 quick-response input bits.

Machine Number Setting and Input Bit No.

When set to machine No.: n (0 to 9), words [100+10n+1] can be used as input bits. Input bits 08 to 15 of word 1n1 can be used as quick-response inputs.

Example: When set to 8, input bits 18108 to 18115 become quick-response inputs.



Machine No. setting switch

Quick-response Input Operation and Timing

With quick-response input function these High-density I/O Modules can read short-pulse input signals, such as those from photomicrosensors.

With standard I/O Modules, an input must be ON during the I/O refresh period for it to be read into the PLC. Input signals shorter than the cycle time can be missed, unless they happen to occur during the I/O refresh.

The quick-response input buffer (on our High-density and Mixed I/O Module) is used to hold input signals as short as 1 ms or 4 ms (selectable) allowing them to be read into the IR area during the next I/O refresh. (Any pulse that is equal to or longer than the minimum time setting affects the program during the next program execution.)

The quick-response input function is available on input points number 08 to 15 on CN2.

SPECIAL I/O MODULES

HIGH-DENSITY OUTPUT MODULE

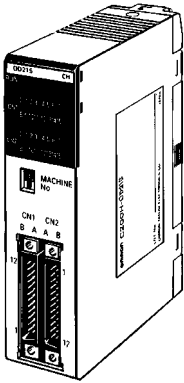

C200H-OD215
(32 transistor output pts.)

C200H-OD501
(32 TTL output pts.)

The High-density Output Modules let you pack more output points into a single I/O slot for greater space savings. Treated as Special I/O modules, they do not use standard I/O points. Thus, they increase the overall I/O capacity. In static high-density mode, they provide 32 discrete output points. In this mode, the modules can also be used with Omron's Terminal Blocks, reducing wiring between control panels as well as within control panels. In dynamic multiplex mode, the modules provide 128 dynamic output points. In this mode they can be used with numeric displays, etc.

Features

- Provide 32 outputs per module in static mode
- Easy cable connection to Omron's XW2B-□ Terminal Blocks using XW2Z-□ Connecting Cable. Refer to the *Standard Parts* section for detailed ordering information.
- Provide interface to numeric displays, etc. in dynamic mode

Specifications

PART NUMBER	C200H-OD215	C200H-OD501
MODULE NAME	TRANSISTOR OUTPUT	TTL OUTPUT
No. of outputs	32	
Rated load voltage	5 to 24 VDC +10%/-15%	5 VDC \pm 10%;
Max. load current	16 mA at 4.5 V to 100 mA at 26.4 V/pt. 800 mA/8 pts. 3.2 A/32 pts.	35 mA/pt. 280 mA/8 pts. 1.12 A/32 pts.
Outputs per common	8 pts	
Output response times	ON: 0.2 ms max. OFF: 0.6 ms max.	ON: 0.2 ms max. OFF: 0.3 ms max.
External connection	connector	
Residual voltage	0.7 V max.	0.4 V max.
Leakage current	0.1 mA max	
External power supply	90 mA, 5 to 24 VDC min.	39 mA, 5 VDC min.
Internal power consumption	220 mA max.	
Manual	W302	

Note: When mounting these models to a Slave Rack, the Remote I/O Master must be the C200H-RM001-PV1 or C200H-RM201.

SPECIAL I/O MODULES

HIGH-DENSITY OUTPUT MODULE

Dynamic Output Mode for Digital Displays

With dynamic outputs, data signals DATA0 to DATA15 are combined with strobe signals STB0 to STB15 to reduce wiring and greatly increase output capacity. The output device must be able to receive dynamic signals.

Position Control Module
C200H-NC111/NC112

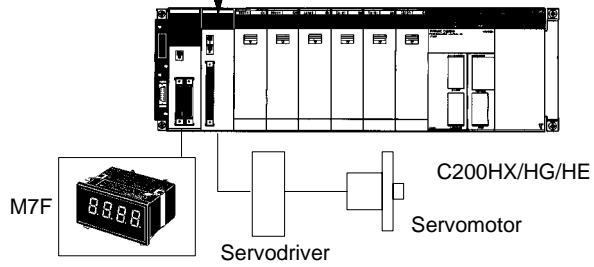

Circuit Configuration

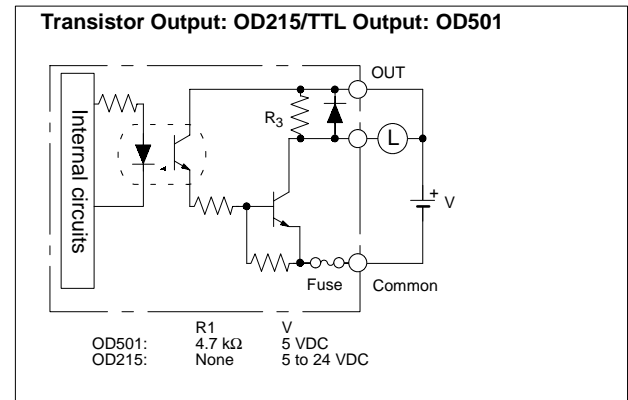

SPECIAL I/O MODULES

MIXED I/O MODULE

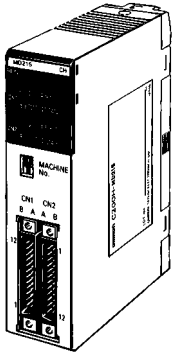

C200H-MD215/MD115
(16 DC input/16 transistor output pts.)

C200H-MD501
(16 TTL input/16 TTL output pts.)

The high-density/multiplex mixed Input/Output modules let you pack more I/O points into a single I/O slot for greater space savings. Treated as Special I/O modules, they do not use standard I/O points. Thus, they increase the overall I/O capacity.

In static high-density mode, they provide 16 discrete input points and 16 discrete output points with selectable input response times of 2.5 ms or 15 ms. For even shorter input signals, 8 inputs can be designated as quick-response inputs, to receive selectable 1 ms or 4 ms signals. In this mode, the modules can also be used with Omron's Terminal Blocks, reducing wiring between control panels as well as within control panels.

In dynamic multiplex input mode, the modules provide 128 dynamic input points. In this mode they can be used with keyboards, thumbwheel switches, etc.

Features

- Provide 16 inputs and 16 outputs per module in static mode; 128 inputs in dynamic mode
- Easy cable connection to Omron's XW2B-□ Terminal Blocks using XW2Z-□ Connecting Cable. Refer to the *Standard Parts* section for detailed ordering information.
- Selectable input response time
- Up to 10 Special I/O modules per PLC
- Provide interface to keyboards, thumbwheel switches, etc. in dynamic mode

Specifications

MODULE NAME		TTL INPUT/OUTPUT MODULE		DC INPUT/TRANSISTOR OUTPUT MODULE			
PART NUMBER		C200H-MD501		C200H-MD215		C200H-MD115	
Inputs	No. of inputs	16 pts					
	Input voltage and current	5 VDC \pm 10%, 3.5 mA (5 VDC)		24 VDC +10%–15%, 4.1 mA (24 VDC)		12 VDC +10%–15%, 4.1 mA typical (12 VDC)	
	Operating voltages	ON: 3.0 V min., OFF: 1.0 V max.		ON: 14.4 V min., OFF: 5.0 V max.		ON: 8.0 V min., OFF: 3.0 V max.	
	Input response times	ON/OFF: 2.5 ms/15 ms (selectable)					
	Isolations	Photocoupler					
	Inputs per common	8 pts					
Outputs	No. of outputs	16 pts					
	Rated load voltage	5 VDC		5 to 24 VDC		12 VDC	
	Max. load current	35 mA/pt, 280 mA/8 pts		100 mA/pt, 800 mA/8 pts		100 mA/pt, 800 mA/8 pts	
	Residual voltage	0.4 V max.		0.7 V max.			
	Output response times	ON: 0.2 ms max., OFF: 0.3 ms max.		ON: 0.2 ms max., OFF: 0.6 ms max.			
	Leakage current	0.1 mA max.					
	Outputs per common	8 pts					
	Fuse	Present (replacement not possible)					
External connection		Connector					
Internal current consumption (5 VDC)		180 mA max.					
Manual		W302					

Note: When mounting any of the above models to a Slave Rack, the Remote I/O Master must be the C200H-RM001-PV1 or C200H-RM201.

Circuit Configuration

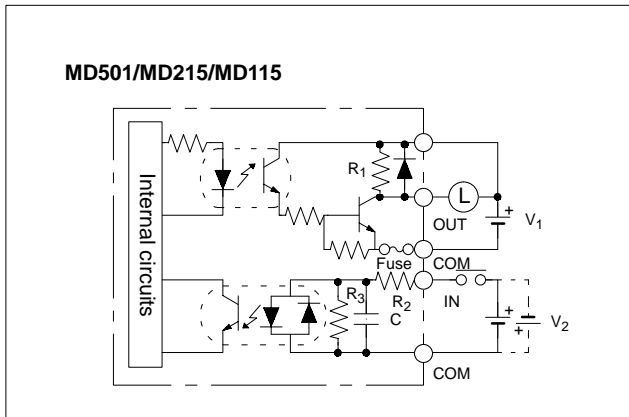

Dynamic Input Mode Operation and Timing

With dynamic inputs, data signals DATA0 to DATA15 are combined with strobe signals STB0 to STB15 to reduce wiring and greatly increase input capacity. For example, when STB0 is ON, as shown to the right, data would be read from DATA0 to DATA3, and the status of switches A through D would be reflected in bits 00 through 03 of word 1n0, where n is the Special I/O Module's unit number.

	R ₁	R ₂	R ₃	C	V ₁	V ₂
MD501	4.7 k Ω	1.1 k Ω	2.4 k Ω	None	5 VDC	5 VDC
MD215	None	5.6 k Ω	620 Ω	1000 pF	5 to 24 VDC	24 VDC
MD115	None	2.7 k Ω	620 Ω	1000 pF	5 to 24 VDC	12 VDC

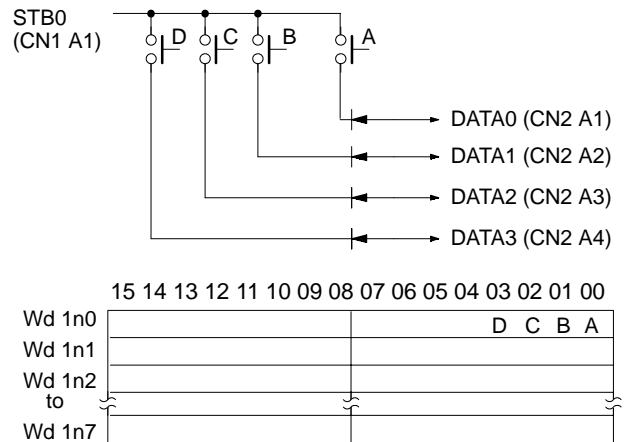

SPECIAL I/O MODULES

ANALOG INPUT MODULES

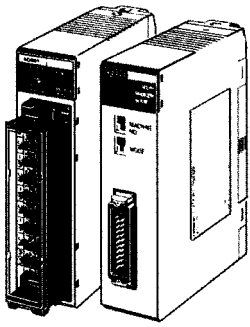

C200H-AD001

C200H-AD002

Analog Input Modules accept a variety of analog signals from external devices, including both voltage and current ranges. Both Modules provide 12-bit resolutions and fast access to the PLC.

Features

- Cost-effective single-slot modules available with 4 or 8 analog inputs
- 12-bit resolution
- Selectable ranges include 1 to 5 V, 0 to 10 V, and 4 to 20 mA

Specifications

PART NUMBER	C200H-AD001	C200H-AD002	
Input points	4	8	
Voltage input	1 to 5V or 0 to 10 V	1 to 5 V, 0 to 10 V, or -10 to 10 V	
	Current input	4 to 20 mA	
External input impedance	Voltage input	1 M Ω min.	
	Current input	250 Ω	
Resolution	Voltage	1/4,000 FS	
	Current		
Total precision	25°C 77.0°F	$\pm 0.5\%$ FS	Voltage: $\pm 0.25\%$ FS Current: $\pm 0.4\%$ FS
	0° to 55°C (32° to 131°F)	$\pm 1.0\%$ FS	Voltage: $\pm 0.6\%$ FS Current: $\pm 0.8\%$ FS
Conversion speed	2.5 ms max./pt		
Converted data	12-bit binary		12-bit binary or 4-digit BCD code (selectable)
Maximum input signals	Voltage input	± 15 V max.	
	Current input	± 30 mA max.	
I/O words required	10 (Special I/O area)		
External connections	Terminal block	Connector	
Current consumption	550 mA max., 5 VDC	450 mA max., 5 VDC	
Weight	450 g max.	290 g max.	
Manual	W127	W229	

System Configuration

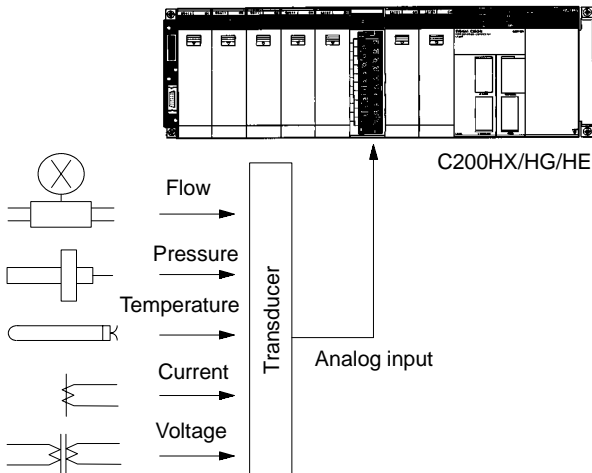

Analog signals, such as voltages and currents, are received from various sensors through the maximum of 8 inputs (AD002) and converted into 12-bit binary data.

External input signal range can be freely set to cope with diverse needs.

Built-in functions included: the scaling function, mean function, peak hold function, square-root extraction function, and more.

SPECIAL I/O MODULES

ANALOG OUTPUT MODULES

Analog Output Module provides an interface to a variety of external analog devices that accept voltage and current ranges, including servo controllers, recorders, and analog gauges.

Features

- Cost-effective single-slot module offers two or four analog outputs
- 12-bit resolution
- Selectable ranges include 1 to 5 V, 0 to 10 V, -10 to +10 V, and 4 to 20 mA

Specifications

PART NUMBER	C200H-DA001	C200H-DA002
Output points	2	4
Voltage output	1 to 5V or 0 to 10 V	-10 to 10 V
	Current output	4 to 20 mA
Resolution	Voltage	1/4,095 FS
	Current	1/4,095 FS
Total precision	25°C 77.0°F	±0.5% FS
	0° to 55°C (32° to 131°F)	±1.0% FS
Conversion speed	2.5 ms max./pt	
External output impedance	0.5 Ω min.	
Maximum external output current	Voltage output	15 mA
	Current output	---
Allowable load resistance of external output	Voltage output	---
	Current output	400 Ω
Converted data	12-bit binary	Voltage code bit + 12-bit binary Current code bit + 12-bit binary
I/O words required	10 (Special I/O area)	
External connections	Terminal block	Connector
Current consumption	650 mA max., 5 VDC	600 mA max., 5 VDC
Weight	450 g max.	320 g max.
Manual	W127	W260

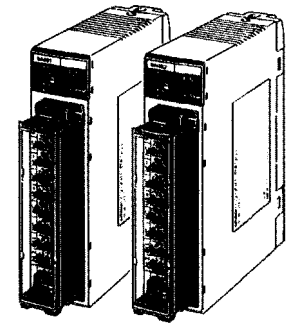

C200H-DA001
C200H-DA002

System Configuration

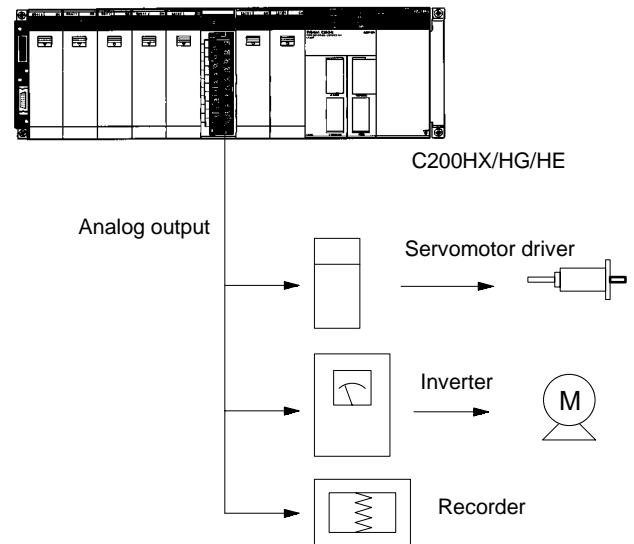

Converts 12-bit binary data into analog signals (voltage or current) for output to external devices.

Output signal range can be freely set to cope with diverse needs. Built-in functions such as the output limit, upper- and lower-limit alarm, and pulse output functions make the C200HX/HG/HE even more powerful.

SPECIAL I/O MODULES

TEMPERATURE SENSOR MODULES

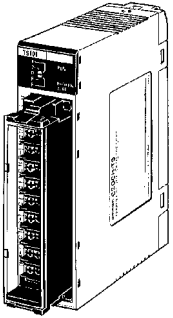

C200H-TS001
C200H-TS101

Monitor up to 4 temperature sensor inputs directly from the PLC rack. Choose thermocouple inputs (types J and K), or platinum RTD inputs. Each module offers multiple ranges and a choice of Fahrenheit or Celsius scaling.

Features

- Available for thermocouple types J and K, or platinum RTD temperature sensors
- Selectable number of inputs
- Wide range of temperature settings

Specifications

PART NUMBER	C200H-TS001	C200H-TS101
TYPE	THERMOCOUPLE	PLATINUM RESISTANCE THERMOMETER
Temperature sensor	Thermocouples: K (CA), J (IC) (selectable)	RTD (JPt 100 Ω)
Input points	4 points/Unit max. (1, 2, or 4 points can be selected)	
Converted data	$\pm(1\% \text{ FS} + 1^\circ\text{C})$ max.	
Total precision	4.8 s max. when 4 points/Unit is set 2.4 s max. when 2 points/Unit is set 1.2 s max. when 1 points/Unit is set	
PLC fetch time	Conversion cycle + PLC1 cycle time (5 s max.)	
Insulation	Between points: Uninsulated Between input terminal and PLC signal: Insulated with a photocoupler	
I/O words required	10 (Special I/O area)	
Current consumption	450 mA max., 5 VDC	
Weight	400 g max.	
Manual	W124	

SPECIAL I/O MODULES

TEMPERATURE SENSOR MODULES

System Configuration

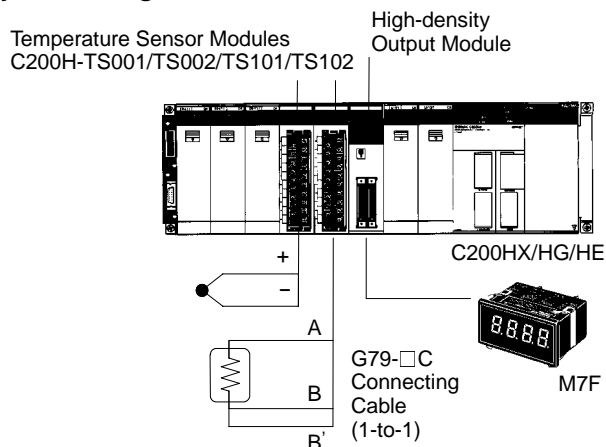

External Connections

C200H-TS001/TS002 Thermocouple Input

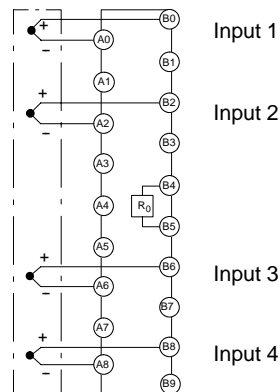

C200H-TS101/TS102 Platinum Resistance Thermometer Input

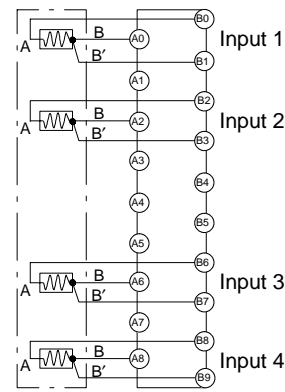

Note: A cold junction compensating circuit, whose precision is adjusted together with the Module, is provided between the B4 and B5 terminals of the C200H-TS001 (for thermocouple).

Temperature Ranges

C200H-TS001

Measuring element	Thermocouple	
	K (CA) Chromel/Alumel	J (IC) Iron/Constantan
Unit	$^{\circ}\text{C}$	$^{\circ}\text{F}$
Measurement ranges	00, 01, 02, 05, 06, 07, 08	03, 04, 09, 10, 11, 12, 13, 14
Temp. spec code (2-digit BCD)		

Note: Use the IR bit for setting the temperature range. (Common settings for 4 inputs.)

C200H-TS101

Measuring element	Platinum Resistance thermometer	
	Pt 100 Ω	
Unit	$^{\circ}\text{C}$	$^{\circ}\text{F}$
Measurement ranges	15, 16, 17, 18, 21, 22, 23	19, 20, 24, 25
Temp. spec code (2-digit BCD)		

SPECIAL I/O MODULES

TEMPERATURE CONTROL MODULES

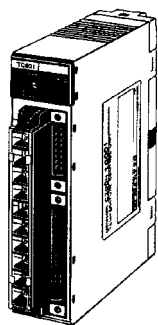

C200H-TC00□

C200H-TC10□

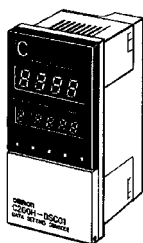

C200H-DSC01
Data Setting
Console

Omron puts accurate temperature control right in the rack to make advanced PID control with auto-tuning readily accessible. Eliminates a need for stand-alone controllers with networks. Display and set parameters with the C200H-DSC01 Data Setting Console. Details on the Data Setting Console are provided later in this section.

Features

- Auto-tuning of PID constants
- The temperature controller accepts inputs from a thermocouple or platinum resistance thermometer. The module is switch-selectable offering ten different sensor types.
- Transistor, voltage, or current output can be selected as the control output.
- High speed and high accuracy temperature control is performed with a sampling period of 500 ms and with an indication accuracy of $\pm 0.5\%$.
- Eight data values such as main set value, alarm set value, and input shift range can be preset in one data bank and a maximum of eight data banks can be preset with each bank preset for a different purpose. It is possible to change the banks during operation.
- Alarm outputs can be selected out of ten modes, such as an upper limit, lower limit, and upper/lower limit.
- The heater current is monitored by the high-precision current transformer (CT) capable of detecting in 0.1 A units. Through the use of heater burnout detection, heater burnout can be quickly detected.
- Data input and process value monitoring – using the Data Setting Console.

Specifications

PART NUMBER	C200H-TC00□	C200H-TC10□
Current transformer detection current	0.1 to 49.9 A (with a heater burnout detecting current difference of 2.5 A min.), indication accuracy: $\pm 0.5\%$ FS, ± 1 digit max.	
Input points (no. of loops)	Two points (two loops, each of which consists of a temperature sensor and CT)	
Temperature control mode	PID, ON/OFF (selectable with a switch on the rear panel) (advanced PID with auto-tuning)	
Preset memory bank items (8 max.)	Main set value, alarm set value, input shift range, proportional band, integral time, derivative time, sensitivity adjustment, etc.	
Setting/Indication accuracy	$\pm 0.5\%$ of set (designated) value or $\pm 2^\circ\text{C}$ whichever larger, ± 1 digit max.	$\pm 0.5\%$ of set (designated) value or $\pm 1^\circ\text{C}$ whichever larger, ± 1 digit max.
Proportional band	0.0° to 999.9°C/°F (in units of 0.1°C/°F)	
Integral (reset) time	0 to 9,999 s (in units of 1 s)	
Derivative (rate) time	0 to 9,999 s (in units of 1 s)	
Control period	1 to 99 s (in units of 1 s)	
Sampling period	500 ms	
Input shift range	-99.9° to 999.9°C/°F (in units of 0.1°C/°F)	
Alarm output mode	Selectable from no alarm function, upper alarm, lower alarm, upper/lower alarm, upper-/lower-range alarm, upper/lower alarm with standby sequence, upper alarm with standby sequence, lower alarm with standby sequence, absolute-value upper alarm, or absolute-value lower alarm.	
No. of banks	8 banks	
Internal current consumption	5 VDC, 0.33 A max. (supplied from the Backplane)	
External supply voltage	24 VDC $+10\%$ / -15% , 200 mA min.	
Weight	360 g max.	
Manual	W225	

SPECIAL I/O MODULES
TEMPERATURE CONTROL MODULES

CONTROL OUTPUT	SENSOR	PART NUMBER
Transistor output	Thermocouple: R, S, K(CA), J(IC), T(CC), E(CRC), B, N, L(IC), U(CC)	C200H-TC001
Voltage output		C200H-TC002
Current output		C200H-TC003
Transistor output	Platinum resistance thermometer: JPt100, Pt100	C200H-TC101
Voltage output		C200H-TC102
Current output		C200H-TC103

System Configuration

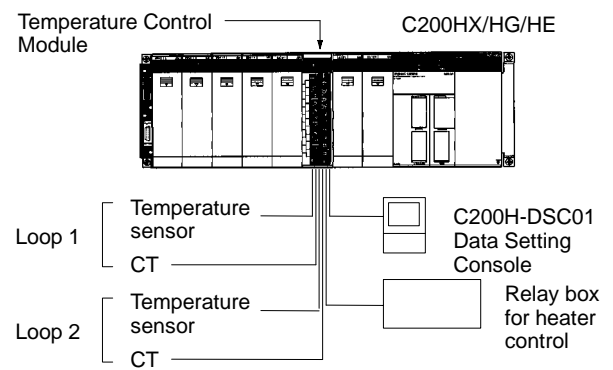

SPECIAL I/O MODULES

HEAT/COOL TEMPERATURE CONTROL MODULES

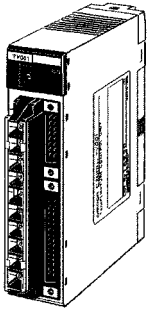

C200H-TV00□
C200H-TV10□

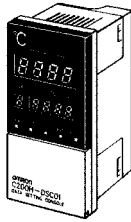

C200H-DSC01
Data Setting Console

Omron puts accurate heat/cool control right in the rack to make advanced PID control with auto-tuning directly accessible on the PLC rack. For applications requiring tight process control, such as plastic extruders. Display and set parameters with the C200H-DSC01 Data Setting Console.

Features

- For stable temperature control, use advanced PID and an auto-tuning feature. ON/OFF control can also be selected.
- Dedicated Module available for each Temperature Sensor. Two types of Temperature Control Module are available, depending on the thermocouple or platinum resistance thermometer temperature sensor used.
- Comprehensive output specifications – three types are available: C200H-TV□□1 for transistor output, C200H-TV□□2 for voltage output, and C200H-TV□□3 for current output.
- Two Heat/Cool Control loops with a single module
- Heater burnout can be quickly detected – a minimum current difference of 2.5 A and a heater burnout detection setting range of 0.1 to 49.9 A allows for the rapid correction.
- Eight banks of data settings, such as set point (SP) and alarm set values, can be preset in eight data banks for easy selection.
- Data Input and Display – The C200H-DSC01 Data Setting Console (sold separately) is used to input data and display process values (PV) and set values (SV). The easy-to-read display can be panel-mounted.
- Data reading/writing User Program of the C200HX/HG/HE allows reading or writing of various data.

Specifications

PART NUMBER	C200H-TV00□	C200H-TV10□
Current transformer detection current	0.1 to 49.9 A (with a heater burnout detecting current difference of 2.5 A min.), indication accuracy: $\pm 0.5\%$ FS, ± 1 digit max.	
Input points (no. of loops)	Two points (two loops, each of which consists of a temperature sensor and CT)	
Temperature control mode	PID, ON/OFF (selectable with a switch on the rear panel) (advanced PID with auto-tuning)	
No. of banks	8 banks	
Setting/Indication accuracy (see note)	$\pm 0.5\%$ of set (designated) value or $\pm 2^\circ\text{C}$ whichever larger, ± 1 digit max.	$\pm 0.5\%$ of set (designated) value or $\pm 1^\circ\text{C}$ whichever larger, ± 1 digit max.
Hysteresis	0.0° to 999.9°C/°F (in units of 0.1°C/°F)	
Proportional band	0.0° to 999.9°C/°F (in units of 0.1°C/°F)	
Integral (reset) time	0 to 9,999 s (in units of 1 s)	
Derivative (rate) time	0 to 9,999 s (in units of 1 s)	
Control period	1 to 99 s (in units of 1 s)	
Sampling period	500 ms	
Input shift range	-99.9° to 999.9°C/°F (in units of 0.1°C/°F)	
Internal current consumption	5 VDC, 0.33 A max. (supplied from the Backplane)	
External supply voltage	24 VDC $+10\%$ / -15% , 200 mA min.	
Weight	360 g max.	
Manual	W240	

Note: The indication accuracy of thermocouples R and S at a temperature of 200°C max., that of thermocouples K and T at a temperature of -100°C max., and that of thermocouple U are all $\pm 4^\circ\text{C}$, ± 1 digit max. The indication accuracy of thermocouple B at temperature of 400°C or below is not guaranteed.

SPECIAL I/O MODULES
HEAT/COOL TEMPERATURE CONTROL MODULES

CONTROL OUTPUT	SENSOR	PART NUMBER
Transistor output	Thermocouple: R, S, K, J, T, E, B, N, L, U	C200H-TV001
Voltage output		C200H-TV002
Current output		C200H-TV003
Transistor output	Platinum resistance thermometer: JPt100, Pt100	C200H-TV101
Voltage output		C200H-TV102
Current output		C200H-TV103

System Configuration

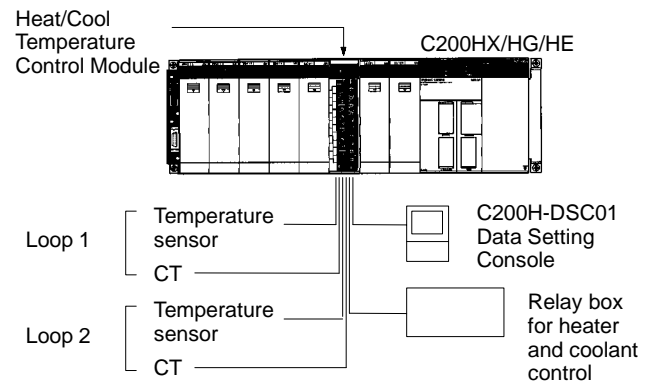

SPECIAL I/O MODULES

PID CONTROL MODULES

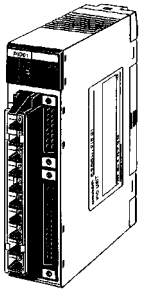

C200H-PID0□

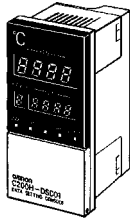

C200H-DSC01
Data Setting Console

This module provides two independent PID loops for process control right on the PLC rack. Based on Omron's E5EX-LA process controller, the C200H-PID0□ accepts both current and voltage analog inputs for pressure, flow and other measurements. The module can be programmed and controlled from the PLC or from the optional Data Setting Console. (Details on the Data Setting console are found later in this section.)

Features

- Advanced PID – stable PID control using advanced PID and an auto-tuning feature. ON/OFF control can also be selected.
- High-speed sampling period of 100 ms – a sampling period of 100 ms is achieved with two loops, enabling high-speed PID control.
- Input noise reduction with digital filter – mitigation of sudden input fluctuations makes the PID Control Module effective in quick-response systems.
- Three types of output specification versions are available: C200H-PID01 for transistor output, C200H-PID02 for voltage output, and C200H-PID03 for current output.
- Eight banks of data settings – eight data values, including set point (SP) and alarm set values, can be preset in eight data banks for easy selection.
- Data input and display using Data Setting Console to input data and display process values (PV) and set values (SV). Easy-to-read display can be panel-mounted.
- Data reading/writing – the user program of the C200HX/HG/HE allows reading or writing of various data.

Specifications

PART NUMBER	C200H-PID0□
Input signal range	4 to 20 mA, 1 to 5 V, 0 to 5 V, 0 to 10 V
Input points (no. of loops)	Two points (two loops, each of which consists of a voltage and a current)
Control mode	PID, ON/OFF (selectable with a switch on the rear panel) (advanced PID control with auto-tuning)
No. of banks	8 banks
Setting/Indication accuracy	±0.5% FS ±1 digit max. The SV and displayed value match. There is no relative error.
Hysteresis	0.0 to 100.0% FS (in units of 0.1% FS)
Proportional band	0.0 to 999.9 (in units of 0.1)
Integral (reset) time	0 to 9,999 s (in units of 1 s)
Derivative (rate) time	0 to 9,999 s (in units of 1 s)
Control period	1 to 99 s (in units of 1 s)
Sampling period	100 ms
Input shift range	-999 to 9,999 (decimal point position is designated by a parameter setting)
Internal current consumption	5 VDC, 0.33 A max. (supplied from the Backplane)
External supply voltage	24 VDC +10%/−15%, 200 mA min.
Weight	360 g max.
Manual	W241

SPECIAL I/O MODULES

PID CONTROL MODULE

OUTPUT	PART NUMBER
Transistor output (open collector)	C200H-PID01
Voltage output	C200H-PID02
Current output	C200H-PID03

System Configuration

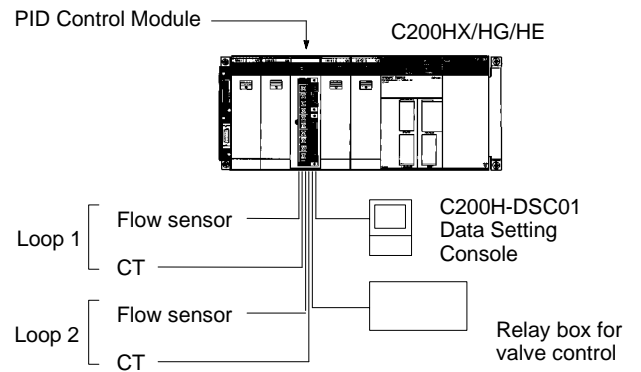

SPECIAL I/O MODULES

DATA SETTING CONSOLE

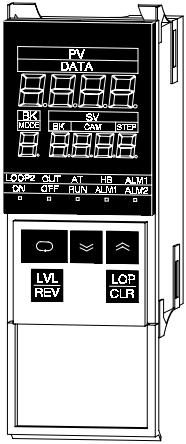

C200H-DSC01

The C200H-DSC01 Data Setting Console mounts on the front panel to display data and provide operator interface for a rack-mounted Temperature Controller Module, Cam Positioner Module and PID Modules. You will need one Data Setting Console to monitor each Module. Included with the C200H-DSC01 are mounting brackets, panel decals for modules to identify the modules and a temperature unit label.

Features

- Fits 1/8 DIN cutouts
- 2 m or 4 m cable
- Change set values, parameters
- Monitor present value, set value and memory bank number as well as output status

Specifications

PART NUMBER	C200H-DSC01
Size	1/8 DIN (48 x 96 mm)
Applicable modules	C200H-TC□□□□ C200H-TV□□□□ C200H-PID□□□ C200H-CP114
Display data	Set value, present value, bank number, auto-tuning, heater burnout alarm, mode, bank, step, cam number, ON/OFF, run, alarm 1 and 2
Connecting cables	2 m: C200H-CN225 4 m: C200H-CN425
Enclosure rating	IP20 (For NEMA 4 rating, use a Y29-49N cover.)

SPECIAL I/O MODULE

FUZZY LOGIC MODULE

The Fuzzy Coprocessor Module allows state-of-the-art fuzzy logic inference processing to be closely integrated with Omron's C200H α PLCs. In addition to normal ladder logic control, the PLC CPU enables pre-processing and post-processing of fuzzy I/O, which is provided by standard Analog I/O Modules, and/or internal registers in the PLC CPU, using intelligent I/O READ and WRITE instructions in ladder logic.

Fuzzy control is best applied to applications that rely heavily on human control and input such as control for overhead cranes, flow control, and temperature control.

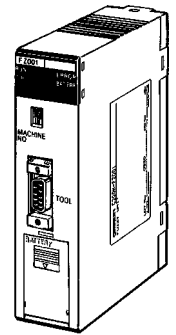

C200H-FZ001

Features

- Up to 8 inputs, 4 outputs
- Up to 128 rules
- User-definable membership functions
- PLC provides pre-processing and post-processing of fuzzy I/O
- The C200HX/HG/HE can handle jobs that used to require highly-experienced operators.

Specifications

PART NUMBER		C200H-FZ001
Fuzzy logic processor	I/O capacity	8 inputs and 4 outputs
	Rule format	8 condition and 2 conclusion parts max.
	Rule capacity	128 rules max.
	Logic process	Forward logic
	Logic rule	MAX-MIN logical product
	Number of labels	7 max.
	Final calculation	Each output can be set independently for calculation by center of gravity, leftmost maximum, or rightmost maximum method.
Membership functions	Condition	Defined by up to 4 end points. Grade (height) at the end points must be either 0 or 1 (0 or 4095). Resolution is 4095 by 4095.
	Conclusion	Only the horizontal position is set. Height is fixed at 4095. Resolution is 4095 by 4095.
I/O words	Inputs	8 words max. Each input is allocated one word.12 bits of the word are used, so the range is 000 to FFF (0 to 4095 decimal).
	Outputs	4 words max. Each output is allocated one word.12 bits of the word are used, so the range is 000 to FFF (0 to 4095 decimal).
Peripheral device communications	Communications	Half duplex
	Synchronization	Start-stop synchronization
	Baud rate	300, 600, 1200, 2400, 4800, 9600, or 19200 (set on DIP switch 2)
	Transmission distance	15 m max.
	Interface	RS-232C port
	Communications protocol	Special procedure (1:N)
Processing time		6 ms max. for Unit, 3 to 4 times the cycle time for system.
Self-diagnostics	Program check	A "memory error" will be generated if an error occurs during the program check.
Data retained in a power interruption		Rules and membership functions are retained.
Internal current consumption		5 VDC, 0.3 A max. (Supplied from the Backplane.)
Weight		400 g max.
Manual		W208

SPECIAL I/O MODULES

FUZZY LOGIC MODULE

System Configuration

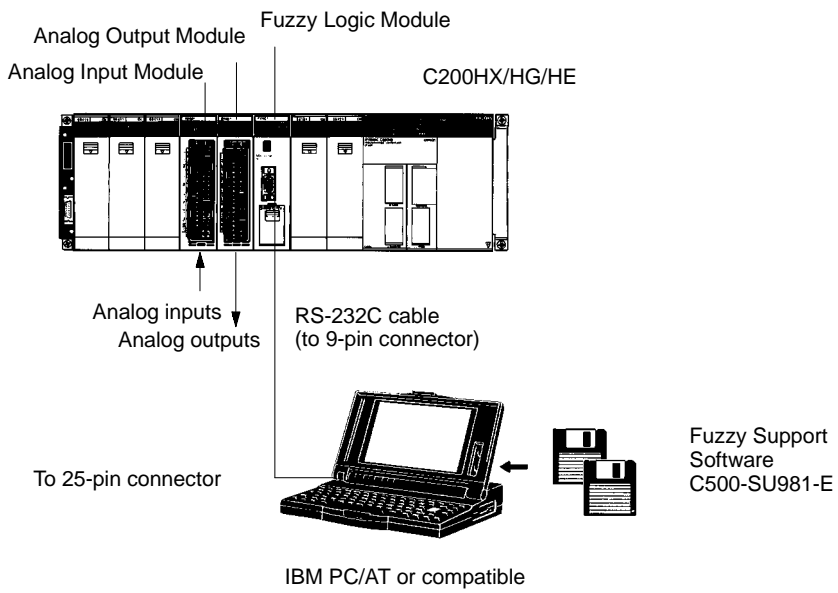

SPECIAL I/O MODULES
DUAL-AXIS MOTION CONTROL MODULE

The dual-axis motion controllers are compatible with servo drivers that accept analog inputs for a complete motion control system. Programs are stored internally in the module and can be selected and monitored from the extensive memory interface available in the PLC.

The Motion Control Support Software (MCSS) provides the program editing, downloading, diagnostic, and on-line monitoring capability to reduce engineering, debugging, and start-up time. (Order separately.)

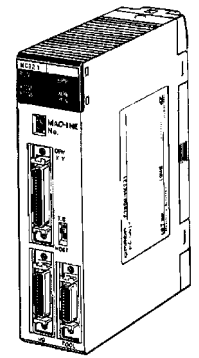

C200H-MC221

Features

- Dual-axis semi-closed loop servo control for simple servo positioning applications
- Internal program storage for fast selection and execution of motion profiles
- Extensive control and monitoring interface reduces maintenance and debugging
- G Code Programming Language subset reduces program development time
- A maximum of 100 programs can be registered
- A maximum of eight modules can be mounted to a single C200HX/HG/HE PLC to control a maximum of 16 axes.

Write Sophisticated Programs Easily – with G-language Programming and MC Support Software.

The functions of the MC Module are set with the MC Support Software.

The MC Support Software has well-constructed menu functions, making it possible to use the MC Module easily. The function groups of the MC Module are classified with the system setup menu and the itemized functions of the MC Module are classified with the main menus.

- These are the main menus of the MC Support Software:
- MC Program Edit Menu
 - MC Parameter Edit Menu
 - Position Data Edit Menu
 - MC Monitoring Menu

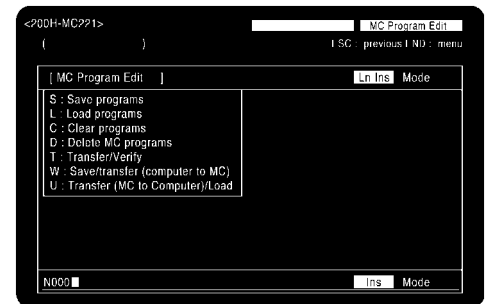

MC Program Edit Menu

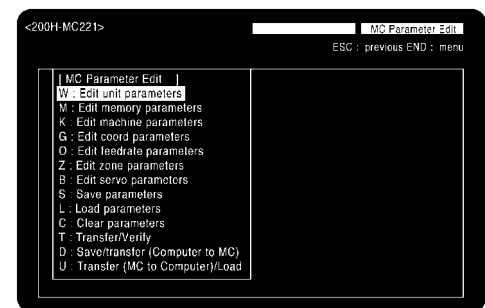

MC Parameter Edit Menu

SPECIAL I/O MODULES

MOTION CONTROL MODULE

Specifications

PART NUMBER		C200H-MC221	
Number of I/O words		20 (2 slots)	
External connecting devices		IBM PC/AT or compatible, Teaching Box, and MPG (manual pulse generator)	
Controlled driver		Servodrivers that can handle analog inputs	
Control	Control method	Semi-closed loop using incremental encoder (speed command voltage output)	
	Number of controlled axes	2 axes max.	
	Number of simultaneously controlled axes	2 axes max.	
	PTP (independent) control	Execution by independent programs, operation modes for each axis	
Positioning	Linear interpolation	2 axes max.	
	Circular interpolation	2 axes max. on a plane	
	Interrupt inching	Inching on an axis with interrupt input to the axis.	
Speed control		Speed control of up to 2 axes. From 1 to 1,000,000 ppc in single-pulse increments (after quadruplication), if pulses are used as the unit of control.	
Control unit	Minimum unit settings	1, 0.1, 0.01, 0.001, 0.0001 (the unit conversion function is not available.)	
	Units	mm, inch, degree, pulse	
Max. command value		-39,999,999 to +39,999,999	
Acceleration//Deceleration curve		Trapezoid or S curve	
Acceleration/Deceleration time		0 to 9,998 ms in 2-ms units can be set independently for acceleration and deceleration.	
Feed operations	Rapid feed speed	Example: 36.86 m/min.	<u>Conditions</u> Encoder resolution: 2,048 p/r Motor speed: 4,500 r/m Control unit: 0.001 mm/pulse Setting unit: 0.1%
	Interpolation feed speed	Example: 36.86 m/min.	
	Rapid feed override	0 to 100%	
	Interpolation feed override	0 to 199%	
	Jog feed override	0 to 100%	
Task program management	Number of tasks	2 max. (program execution units)	
	Number of programs	The maximum number of programs differs according to the number of tasks (e.g., 100 programs are controlled if 1 task is used and 50 programs are controlled if 2 tasks are used).	
Task program management	Program capacity	The maximum number of program blocks varies with the number of tasks (e.g., 800 program blocks are controlled if 1 tasks is used and 400 program blocks are controlled if 2 tasks are used).	
	Position data capacity	2,000 max. when only 1 axis is used.	
	Number of registers	32 (mainly used to specify position data numbers)	
	Sub-program nesting	5 levels max.	
Auxiliary function	M code	0 to 999	
Internal current consumption		0.65 A (0.85 A with Teaching Box connected) at 5 VDC 0.2 A at 24 VDC	
Weight		500 g max.	
Manual		W314, W315, W256	

SPECIAL I/O MODULES

MOTION CONTROL MODULE

System Configuration

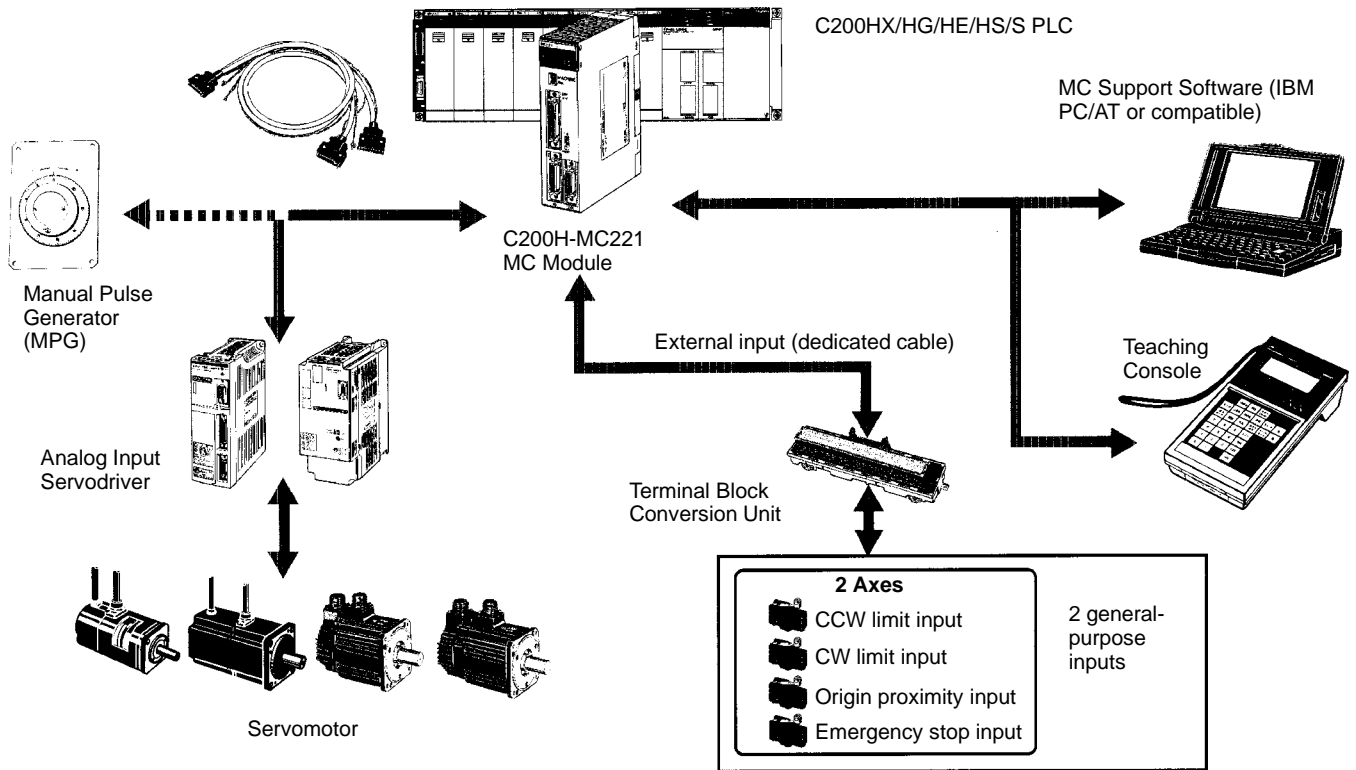

SPECIAL I/O MODULES

POSITION CONTROL MODULE

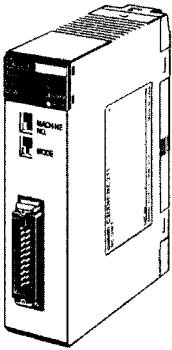

C200H-NC211

C200H-NC112

Position control modules provide either a step and direction pulse train or CW/CCW pulse trains to control a single- or dual-axis stepper or servo motor driver. Interface signals include CW and CCW limits, origin approach, origin stop, emergency stop, and interrupt signals. Automatic backlash and origin offset functions are now included for precise positioning requirements. Move parameters can be set up in either ladder logic, or by connecting the hand-held programming console and are stored in battery-backed memory. Extensive diagnostics are also available to the PLC for quick error detection and troubleshooting.

Features

- Pulse output for stepper motor or servo motor driver
- Origin and backlash compensation for precision positioning
- Teach mode or storage of calculated movement parameters
- Internal diagnostics
- External signal interface for CW, CCW, origin, emergency stop, mode, and interrupt
- Parameters, speeds, and positions set in CPU DM area
- Linear interpolation capability on C200H-NC211

Additional Functions – C200H-NC211 Only

- Simultaneous two-axis control is possible with single-axis independent control and two-axis linear interpolation.
- Position data or speed data can be changed or transferred from the PLC to the NC211 while the positioning operation is stopped.
- Speed can be changed using the speed coefficient, even during positioning operation.
- Up to 53 positions can be set on both axes.

Specifications

PART NUMBERS		C200H-NC211	C200H-NC112
Axes controlled		2 axes/Module	1 axes/Module
Control system		Automatic trapezoidal acceleration/deceleration	
Position	Data	-8,388,607 to 8,388,606 pulses	
	Data capacity	53/axis	20
Speed	Data	1 to 250,000 pps	
	Data capacity	15	
Speed adjustment rate		2 to 2,000 pps/1 ms	
Origin search	Origin proximity	None/NO/NC When provided, H/L level selection is available.	
	Origin signal	Rise or fall selection	
	Origin compensation	0 to $\pm 9,999$ pulses	
	Origin search speed	High speed, proximity speed setting available	
Backlash compensation		0 to 9,999 pulses	
Manual operation		High-speed jog, low-speed jog, inching	
I/O words required		20 (Special I/O area)	10 (Special I/O area)
Internal current consumption		5 VDC, 0.5 A max.	5 VDC, 0.2 A max.
Weight		500 g max.	400 g max.
Manual		W166	W128

SPECIAL I/O MODULES

POSITION CONTROL MODULE

Connection Example – Servo Motor for the Pulse-train Input

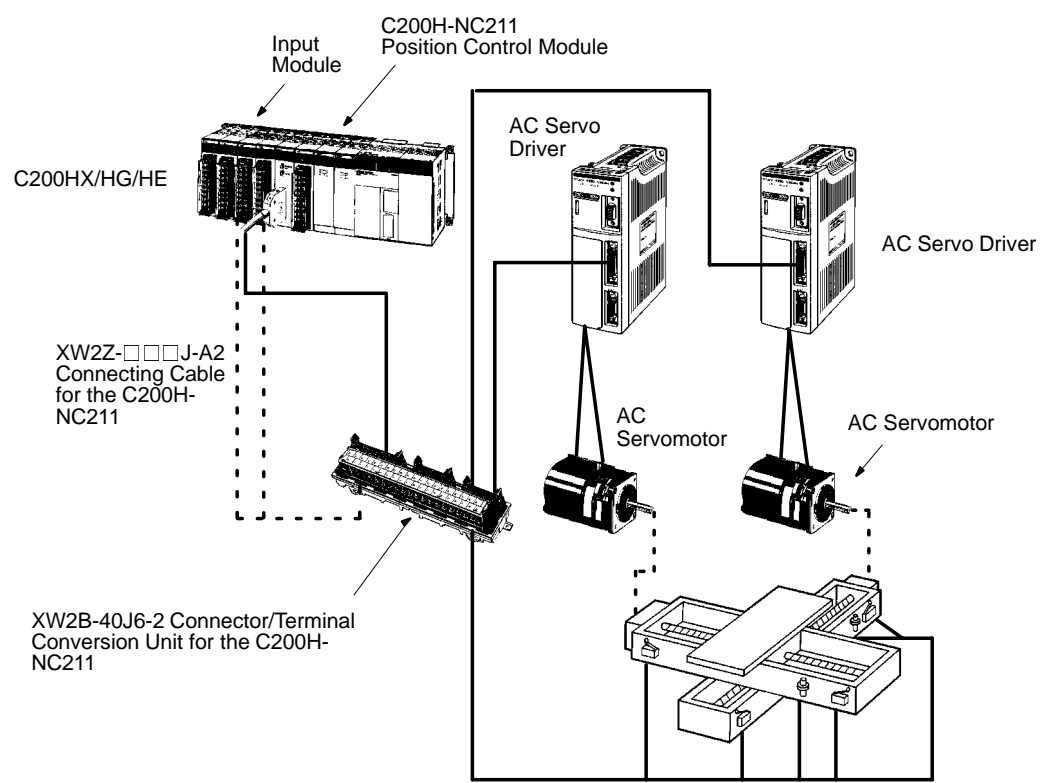

SPECIAL I/O MODULES

HIGH-SPEED COUNTER MODULE

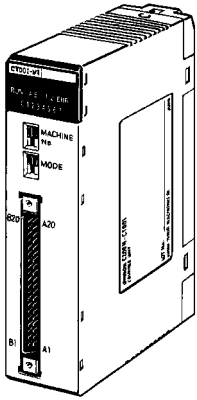
**C200H-CT021****C200H-CT001-V1****C200H-CT002**

The high-speed counter modules provide an interface for applications where the counting speed exceeds the PLC's processing speed. Typical applications include frequency inputs, rotary encoder interface, position control, cut to length, and motion control. Built-in I/O and front panel indicators on the module allow for faster throughput and easy visual monitoring of module status. Interface signals include count inputs, integral outputs, and external resets.

Features

Two counters count input signals at a high speed of 75 kcps max. (C200H-CT021) from Incremental Rotary Encoders or other sources.

Seven counting modes for varied applications:

Simple counter mode counts input pulses (available with the C200H-CT021 only)

Drum operations linear mode, circular mode

Preset counter operations – preset mode

Counting operations – gate mode (normal and cumulative), latch mode, sampling mode

- Three input modes available: differential phases, up/down inputs, pulse and direction inputs
- Provided with multiplication function (x2/x4) for differential phase input
- Count values can be set in either BCD or HEX

Note: A maximum of 16 C200H-CT021 Modules can be mounted to a single C200HX-CPU5□-E, C200HX-CPU6□-E, C200HG-CPU5□-E, or C200HG-CPU6□-E CPU.

SPECIAL I/O MODULES

HIGH-SPEED COUNTER MODULE

Specifications

PART NUMBER		C200H-CT001-V1	C200H-CT002	C200H-CT021
Number of axes		1 axis/Module		2 axes/Module
Operating modes		6		7
Count input	Input signal	Encoder inputs A, B		Counter 1 inputs A, B Counter 2 inputs A, B
	Signal level	5, 12, or 24 VDC (selected when wiring)	RS-422 line driver (Am26LS31-compatible)	12 or 24 VDC (selected when wiring) RS-422 line driver (Am26LS31-compatible)
	Input modes	Differential, up/down, pulse and direction		
	Counting speed (see note)	50 kcps	75 kcps	
	Other	Input multiplier (x2 or x4) available for differential inputs		
External input	Input signal	Counter input Z		Counter 1: input Z Counter 2: input Z
	Signal level	External control inputs IN1 and IN2		Counter 1: external control inputs IN1 and IN2 Counter 2: external control inputs IN1 and IN2
		5, 12, or 24 VDC (selected when wiring)	RS-422 line driver (Am26LS31-compatible)	12 or 24 VDC (selected when wiring) RS-422 line driver (Am26LS31-compatible)
	Input signal	Control inputs IN1, IN2		
	Signal level	5, 12, or 24 VDC (selected when wiring)		12 or 24 VDC (selected when wiring)
External output	Output	External outputs 0 to 7 (8 points)		
	Output level	External output power supply: 5 to 24 VDC Switching capacity: 16 to 80 mA		
I/O words required		10 (Special I/O area)		
Internal current consumption		5 VDC, 0.3 A max.		5 VDC, 0.4 A max.
Weight		400 g max.		305 g max.
Manuals		W141	W141	W311

Note: Affected by the differential phase pulse input.

System Configuration

A High-speed Counter Module counts input signals from incremental rotary encoders or other sources.

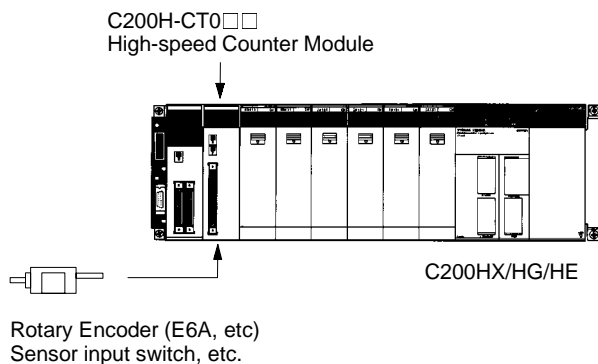

SPECIAL I/O MODULES

CAM POSITIONER MODULE

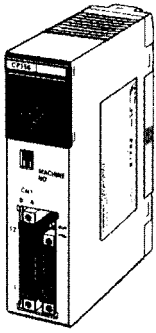

C200H-CP114

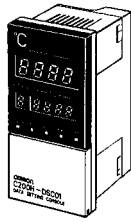

**C200H-DSC01
Data Setting Console**

The Cam Positioner Module simulates a rotating mechanical cam, drum sequencer, or programmable limit switch in a PLC I/O module. The module provides a resolver interface and uses the Data Setting Console for displaying values.

Features

- The cam outputs can be set at 16 external outputs and 32 internal outputs with a total of 48 points. The internal outputs can be taken directly into the C200HX/HG/HE, reducing wiring inside the control panel.
- The ON/OFF data for the maximum of seven points can be set for one cam. Data can be registered in one bank. To facilitate easy set-up changes during operation, a maximum of eight banks is available for data setting.
- The Data Setting Console allows easy monitoring of cam data settings, present cam angles, or resolver rpm.
- To provide an optimum output, use the adjustable operation function to make fine adjustments of the ON/OFF data.
- Data on operating conditions – such as the present cam angle, cam outputs for 48 points, resolver rpm, and resolver status – can be constantly monitored from the C200HX/HG/HE side.
- Using origin compensation, the machine origin and the resolver origin can be easily matched.
- The resolver rpm can be converted into an actual production quantity by using the scaling function.

Specifications

PART NUMBER	C200H-CP114
Output points	48 points (16 external output points, 32 internal output points)
External outputs	NPN transistor open collector (with photo-coupler insulation) Switching capacity: 100 mA at 24 VDC Simultaneous ON points: 8 points max.
Resolver cable length	100 m max.
Resolver response rpm	800 rpm max.
Resolver response speed	200 μ s (at a sampling frequency of 5 kHz)
Resolver resolution	1°
Program memory	EEPROM (8 banks)
Origin compensation	1° or 359° (The present angle needs to be compensated to 0°)
Internal current consumption	5 VDC, 0.3 A max. (Supplied from the Backplane.)
External power supply	24 VDC +10%/-15%, 2 A min.
Weight	350 g max.
Manual	W224

SPECIAL I/O MODULES

CAM POSITIONER MODULE

System Configuration

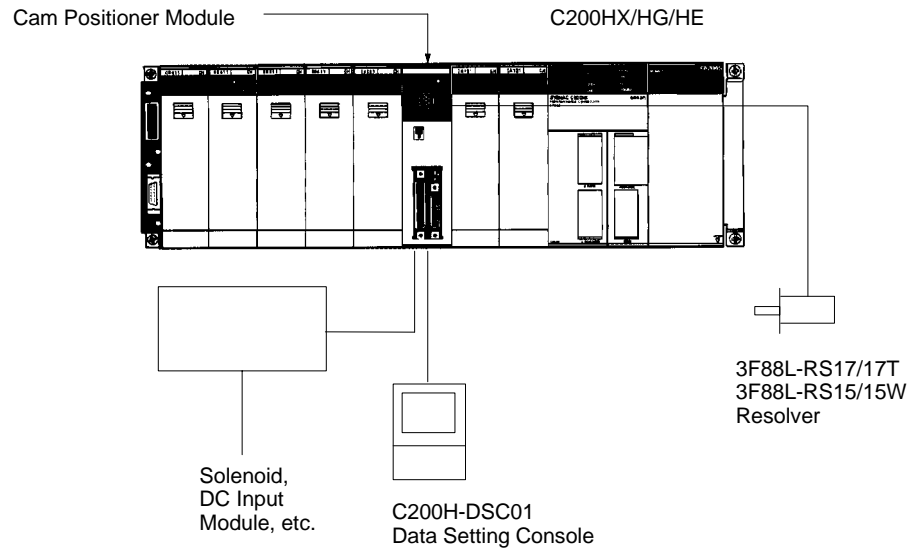

SPECIAL I/O MODULE

ASCII/BASIC MODULE

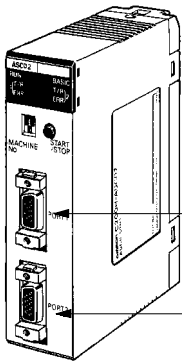

- Two RS-232C Ports**
 Bidirectional serial interface to
- Computers
 - Printers
 - Bar code readers
 - PLCs
 - Other ASCII devices

C200H-ASC02

The ASCII/BASIC Module provides a 24-Kbyte programmable coprocessor module that operates independently of the PLC. Two built-in RS-232C ports provide easy interface to a variety of external devices including other manufacturers' PLCs, computer terminals, operator stations, bar code readers, and any other device utilizing a serial interface. The module is programmable in either BASIC or Assembly providing a platform for complex calculations and algorithms at the PLC level. This includes PID, gas flow calculations and complex math and string manipulation functions. Communications can be initiated by either the module or the PLC.

Features

- 24-Kb, battery-backed RAM and 24-Kb EEPROM programmable in BASIC or Assembly languages
- Special commands to initiate communication with the PLC
- Two RS-232C ports, 19,200 baud maximum speed
- Built-in clock/calendar including year, month, day, date, hour, minute, second (accurate to 30 seconds/year)

Specifications

PART NUMBER	C200H-ASC02
Baud rate	Port 1: 300 to 9,600 bps Port 2: 300 to 19,200 bps
Transmission distance	15 m max.
Memory capacity	BASIC program area: 24K bytes (RAM) BASIC program storage area: 24K bytes (EEPROM)
Transmission capacity	255 words max. at 20 words per cycle
Diagnostic functions	CPU watchdog timer, battery voltage drop
Battery life	5 years at 25°C (77°F) The life of the battery is shortened if the Module is used at higher temperatures.
I/O words required	10 (Special I/O area)
Internal current consumption	5 VDC, 0.2 A max.
Weight	400 g max.
Manual	W165

SPECIAL I/O MODULES

ASCII/BASIC MODULE

System Configuration

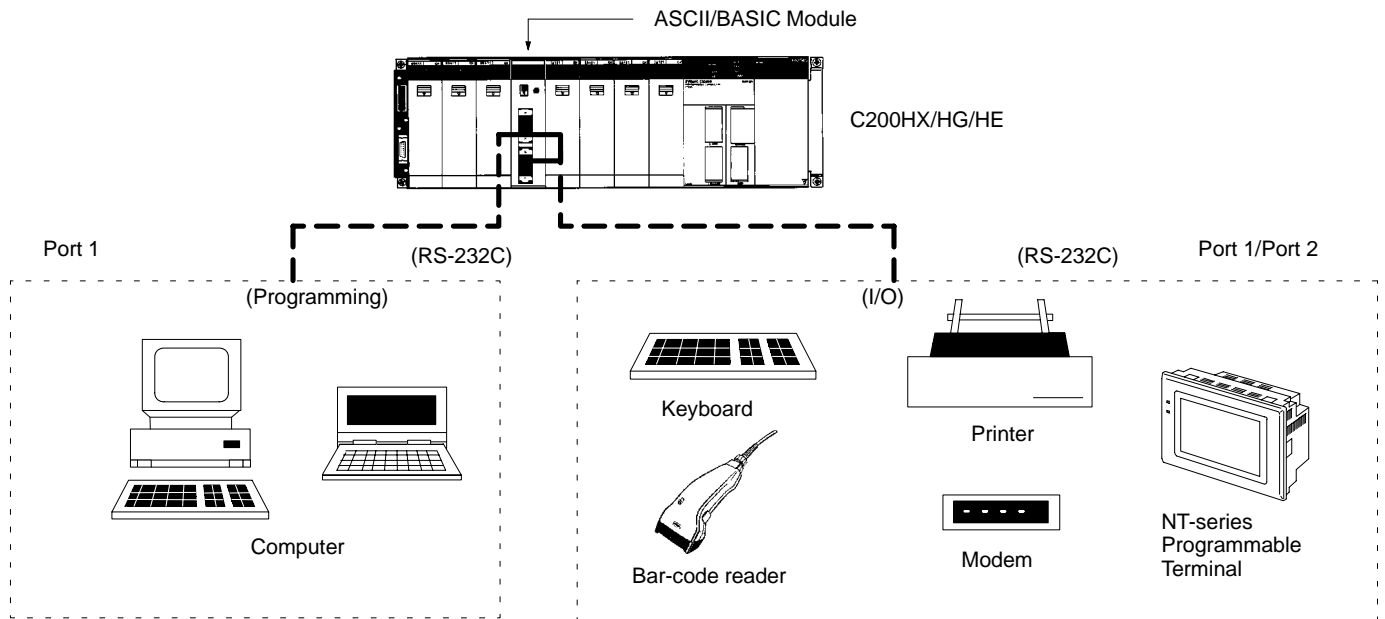

SPECIAL I/O MODULES

VOICE MODULE

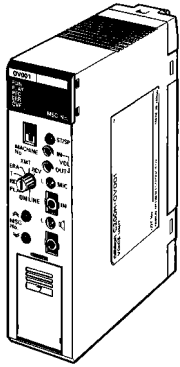

C200H-OV001

Input Devices

- Computer
- Microphone
- Tape recorder

Output Devices

- Computer
- Printer
- Speaker

Use the Voice Module for operator interface messages. Record up to 60 voice messages on site, or use a tape recorder and transfer the messages to the module. Messages can also be uploaded or downloaded through the RS-232C port on the front panel. The built-in speaker enables immediate message verification. Message length and sound quality are selectable.

- Microphone jack enables live message broadcast
- Flexible message length
- Messages can be interrupted to start another message
- Messages can be recorded in phrase and word combination formats
- Upload or download messages through the RS-232C port on the front panel

Specifications

PART NUMBER		C200H-OV001
Voice synthesis method		Adaptive differential pulse-coded modulation (ADPCM)
Message	Recording time	32, 48, or 64 s (switch selectable)
	Capacity (sentences and phrases)	60 max.
Message input (switch-selectable)	MIC IN	Microphone input: Unbalanced dynamic microphone (600 Ω)
	LINE IN	Tape input: Input impedance: 50 k Ω , unbalanced; Maximum input voltage: 3.3 V
Message output (switch-selectable)	SPEAKER OUT	Built-in amplifier output: 0.14 W (8 Ω speaker)
	LINE OUT	External amplifier output: 600 Ω unbalanced transformer output Maximum output voltage: 0.5 V rms (effective value) Both balanced and unbalanced external amplifiers can be connected.
Built-in monitor speaker		Diameter 27 mm, 0.1 W (8 Ω)
Input frequency		32-second recordings: 8 kHz 48-second recordings: 5.3 kHz 64-second recordings: 4 kHz
Output frequency characteristics		32-second recordings: 100 Hz to 3.2 kHz 48/64-second recordings: 100 Hz to 2.2 kHz
Low-pass filter (LPF) selector function (see note)		Cutoff frequency: 3.2 kHz for 32-second recordings, 2.2 kHz for 48/64-second recordings
Message memory		128K bytes RAM (battery powered)
External communication function (for saving recorded messages)		RS-232C (Baud rate: 19,200/9,600/4,800/2,400 bps. XON/XOFF: yes/no, CTS/RTS: yes/no)
Self-diagnosis function		CPU watchdog timer, LOW battery voltage detection
Battery life		5 years at 25°C (battery life is shorter for higher temperatures)
I/O words required		10 (Special I/O area)
Internal current consumption		5 VDC, 0.3 A max.
Weight		400 g max.
Manual		W172

Note: The recording time of the Voice Module is varied by changing the unit's input frequency. For improved sound quality, the cutoff frequency of the low-pass filter is automatically changed to a lower frequency when the recording time is increased from 32 to either 48 or 64 seconds. (The output frequency is set to 100 Hz to 2.2 kHz when the recording time is set to 48 or 64 seconds.)

SPECIAL I/O MODULES

VOICE MODULE

System Configuration

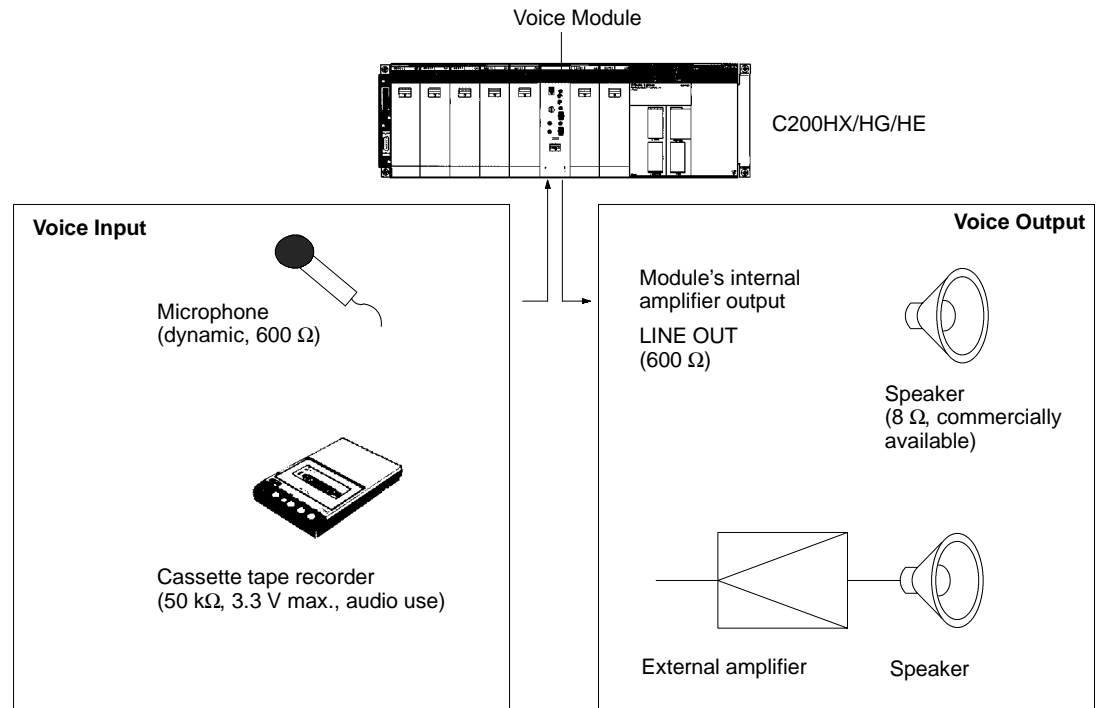

SPECIAL I/O MODULES

RFID SENSOR MODULE

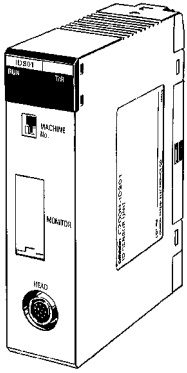

C200H-IDS01-V1
(electromagnetic, for short distances)

C200H-IDS21
(microwave, for long distances)

The RFID Modules provide a direct interface to Omron's V600 and V620 C200H RFID Sensor Read/Write Heads. The module acts as the controller for Read/Write Heads that exchange data with data carriers using RF technology. Applications include conveyor and pallet storage, product labeling, warehousing applications, and more. Up to 8 Kb of data can be stored on a single data carrier. The interface modules provide a quick and easy interface to the production line PLC using ladder diagram programming.

Features

- Provide flexibility in handling individual workpieces or pallets by reading product specifications can be read from ID data carriers (tags)
- Allows up-to-date access information on inventory and material flow
- System consists of an ID controller or SYSMAC C200H-IDS Module, Read/Write (R/W) heads, and data carriers (tags)
- Three Read/Write ranges available
- Direct monitoring from the C200H-IDS Module with hand-held programming console

Specifications

PART NUMBER	C200H-IDS01-V1 AND C200H-IDS21
Communication control procedure	Interactive
Number of R/W Heads (antennas) connected	One per RFID Sensor Module
Data Carrier (DC)	2K-byte SRAM (with replaceable battery), 8K-SRAM (with built-in battery) 256-byte EEPROM
Data Carrier memory format	8-bit format
Commands	The following seven commands are used: Read, Write, Auto Read, Auto Write, Clear-all, Auto Read/Write Abort, and Data Management (C200H-IDS01-V1 only)
Data transferrable per instruction	Up to 512 words (1024 bytes) can be transferred at 20 words/scan.
Diagnostic functions	<ul style="list-style-type: none"> • CPU watchdog timer • Communication errors – Data Carrier Missing Six communication errors identify the causes of errors that have occurred during communication between the Data Carrier and the RFID Sensor Module • Error Log The Error Log function allows communication errors to be displayed in statistical form or in order of occurrence. Error information is retained by the back-up capacitor.
Monitoring functions	The following monitoring functions are available when the RFID Sensor Module is connected to a Hand-held Programming Console. Use the keyboard sheet provided with the RFID Sensor Module. (Cable length: 4 m max.) Read (1 byte) Stepwise Write (1 byte) Continuous Write Test Error Log
Memory backup	Error information is backed up by a capacitor for 15 days (at 25°C).
I/O words required	5 (Special I/O area)
Internal current consumption	5 VDC, 0.25 A max. 26 VDC, 0.12 A max. (to drive Read/Write Head or R/W Antenna) See note.
Weight	400 g max.
Manual	W153

Note: The Read/Write Head (or Antenna) is supplied 26 VDC. Refer to the *C200H PLC Installation Guides (W111 and W218)* for information on system design.

SPECIAL I/O MODULE

RFID SENSOR MODULE

System Configuration

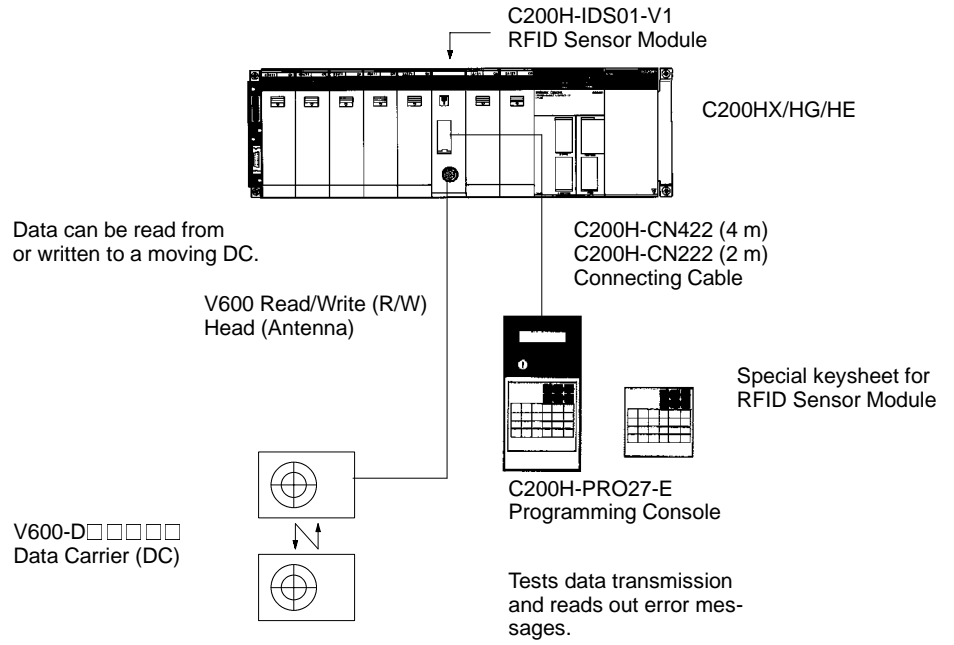

Further details on RFID components can be found in Catalog Q80-E3-□.



COMMUNICATIONS

69

Overview	70
Communication Modules	72
Fiber-optic Cable and Connections	89

COMMUNICATIONS

OVERVIEW

Plant-wide Information Management and Control Networks

Omron's advanced plant-wide information management network capabilities let you harness the power of valuable manufacturing and production data stored throughout your plant and turn it into a competitive advantage. Omron's ethernet connectivity allows customers to interface PLCs with higher level business computing systems and other PLCs via Ethernet. To link your supervisory computers and factory controllers in a seamless, high-speed, high-capacity network, use Omron's fiber-optic based SYSMAC NET communications network. Twin fiber-optic cables, automatic loopback, and a token ring configuration provide a reliable, deterministic interface to a variety of information systems. SYSMAC NET's fast, 2 Mbps transmission speed and 2 Kb message size moves large amounts of data quickly.

Distributed Control Networks

By more tightly integrating their control systems, many manufacturers have been able to increase productivity and manufacturing flexibility. Omron's SYSMAC LINK distributed control network provides a high speed (2 Mbps) link for exchanging critical production data between supervisory computers and programmable controllers in real time. The token bus peer-to-peer network uses noise resistant fiber-optic or low cost co-axial cable media for reliable, deterministic communications. A special data link feature provides an easy to set up, shared memory system for even tighter integration between multiple controls and computers.

Operator Interface Terminals on Networks

Omron's Host Link serial network provides an ideal interface for today's data-hungry data acquisition and control software, or local operator interface. Multiple Operator Interface Terminals can be connected to a PLC using the Host Link module. Drivers for this openly available protocol have been developed for all major third-party operator interface and control software packages and operator interface devices.

Device-level Networking

Omron offers several options for the networking to factory floor devices. Omron's DeviceNet products are compatible with the DeviceNet specification and provide a variety of distributed I/O solutions. DeviceNet is an open communications protocol that allows several vendors' products to exist on a single network, giving the customer a wide variety of options to choose from.

Omron's SYSMAC Bus remote I/O systems significantly lower wiring and maintenance costs. The SYSMAC Bus remote I/O connects CPUs and distant I/O using low-cost twisted pair wiring or fiber-optic cables.

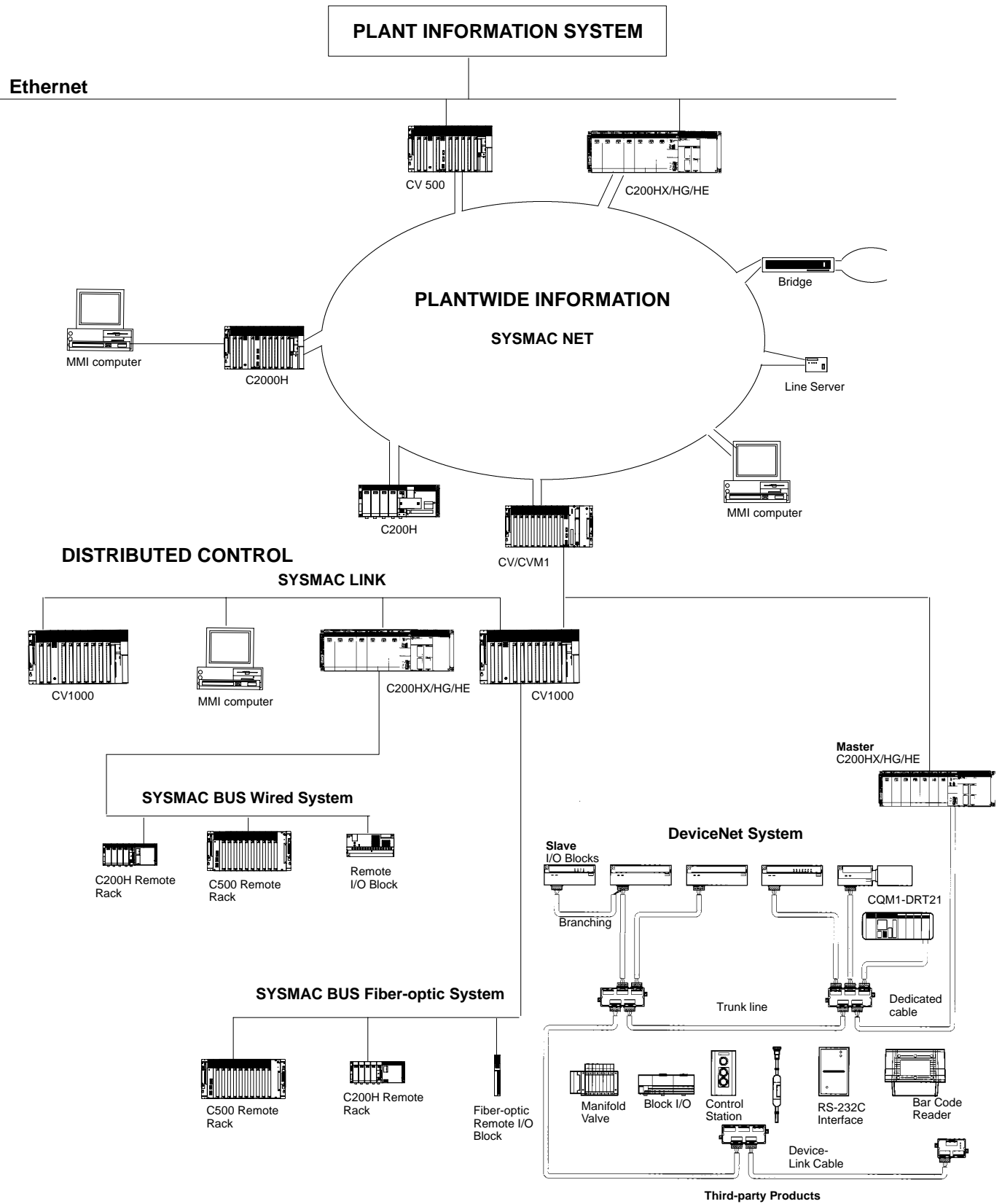

COMMUNICATIONS MODULES

PC CARD MODULES

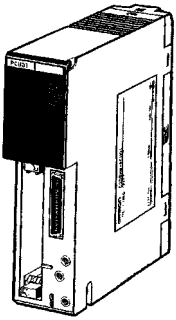

C200HW-PCU01-E
PC Card Module

C200HW-PCS01-E
Ethernet Set
(setup utility driver provided)

Communications Board
C200HW-COM01
C200HW-COM04-E
(with RS-232C port)

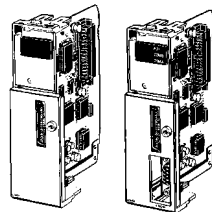

Bus Connection Unit
C200HW-CE011
(for 1 Module)
C200HW-CE012
(for 2 Modules)

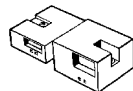

Connect to ethernet networks with ease and exchange data files using PCMCIA cards. The PC Card Module provides two PCMCIA interface slots. Two type-I or type-II cards or one type-III PCMCIA card can be installed. Using the C200HW-PCU01-E, C200H α memory contents may be written to memory cards as files, to exchange production data between PLCs and PCs. Using the C200HW-PCS01-E with an Ethernet-compatible PCMCIA card, data may be exchanged using FINS protocol via UDP/IP.

Features

Data storage and ease of production stage change with Memory Cards.

- A standard SRAM or FLASH card inserted into the slot is used as file storage
- Data can be loaded and saved between the PLC and memory cards using CMCR (CARD MACRO) instructions
- Data written with the PC Card Module to memory cards is read with the IBM PC/AT or compatible and vice versa

Connects to Office Networks with Ethernet Cards

- A standard Ethernet Card can be inserted into the slot and, using the RS-232C port on the front panel, can be set to allow connection of the C200HX/HG/HE PLC with the Ethernet
- Data is loaded and saved between the CPU and host computer by using OMRON's unique FINS (Factory Intelligent Network Service) commands. In addition, the PC Card Module allows the PLC to execute the SEND/RCV instruction to communicate with the host computer or other PLCs.

PC Card Module Specifications

PART NUMBER	C200HW-PCU01-E
CPU	i80386-SX25 MHz
Memory	1 MB DRAM
ROM	512 KB (for BIOS, DOS, and system file storage)
FLASH ROM	1 MB (for BIOS, DOS, and system file storage)
Serial port	RS-232C x 1 (for terminal connection setup)
PC card interface	PCMCIA 2.1 (3.3-V type is not supported.) Type II x 2 slots or type III x 1 slot
Indicators	RUN, ERR, PC card access, and PC card formatting
Power supply	5 VDC (supplied by the Power Supply Unit)
Dimensions	34.5 x 130 x 125 (W x H x D)
Weight	400 g max.

Note: i80386 is a registered trademark of Intel Corp. Ethernet is a registered trademark of Xerox, Corp.

System Configuration

Data Storage and Easy Production Stage Changes using Memory Cards

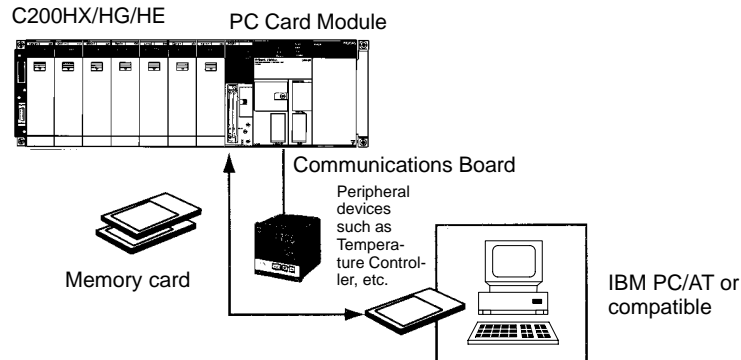

Connects to OA Networks using Ethernet Cards

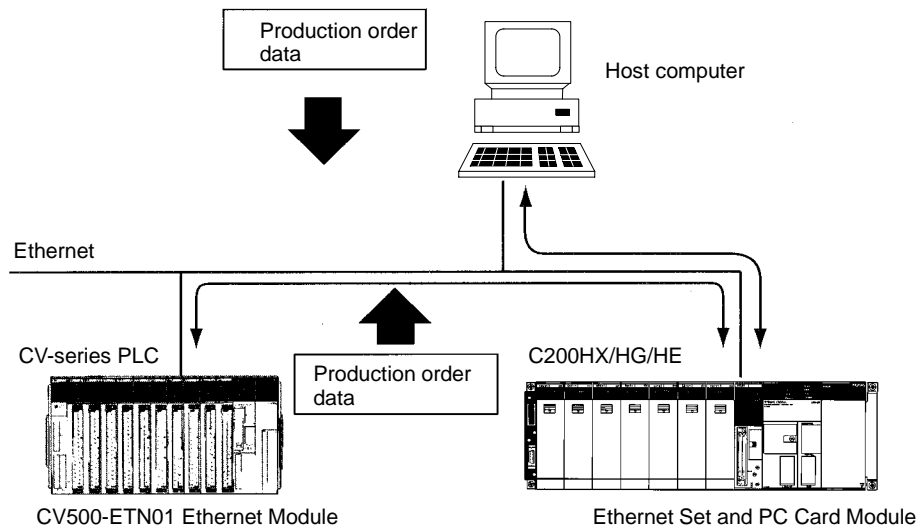

Recommended Memory Cards

MANUFACTURER	PRODUCT
SunDisk compatibles	SDP5100A (FLASH PACKER series)
Intel	IMC001FLKA (FLASH Card)

Note: OMRON does not guarantee the performance of the above memory cards although OMRON has confirmed that the above memory cards are suitable for the PC Card Module.

Recommended Ethernet Cards

MANUFACTURER	PRODUCT
Kingston Technology	KNE-PCM/T
Others	ODI SPEC3 Compatible

COMMUNICATIONS MODULES

PC CARD MODULE

Possible Configurations When Installing PC Card Modules

Standard Mounting – for PC Card Module

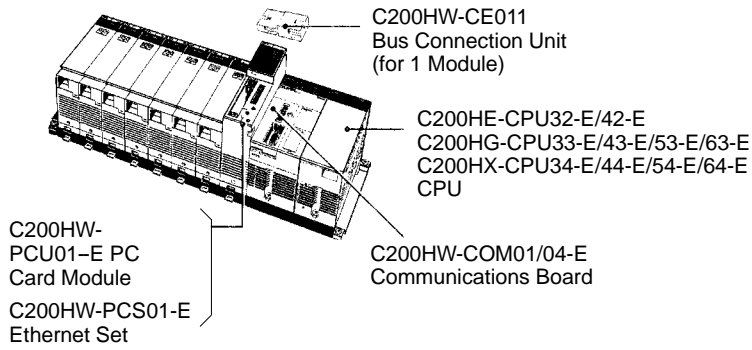

Mounting with the SYSMAC LINK Module

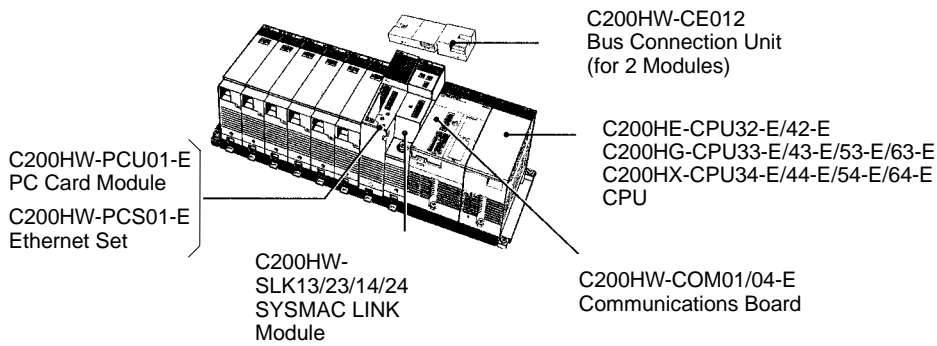

COMMUNICATIONS MODULES

SYSMAC NET LINK MODULE

SYSMAC NET is a fiber-optic token ring network designed to transfer large amounts of data between the PLC and IBM PC/AT Compatible, VME computers, and any ASCII RS-232C devices. Fiber-optic transmission media provides reliable long distance communications in harsh environments. Automatic loop-back, extensive diagnostics, and network utility software provide added reliability and ease of configuration. The C200HS-SNT32 SYSMAC Module is easily integrated to the C200H α CPU. The Module connects to the CPU through one of the C200HW-COM01/COM04-E Communications Boards with a C200HW-CE001/CE002 Bus Connector.

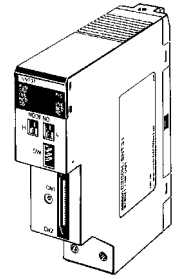

C200HS-SNT32

Features

- Achieves high-speed and long-distance communications through Fiber-optic Cables – N:N token ring communications method is available. Transmission is possible with a node separation of 1 km and a data transmission rate of 2M bits/s. Transmission up to 3 km is possible when a long-distance repeater is connected.
- Large-scale FA Network configuration – Up to 126 NSB, NSU, and SYSMAC NET Link Modules can be connected. Connect the PLC to a factory computer or host computer network.
- Improved redundancy capabilities – The automatic loop-back and node separation test facilitate the taking of prompt countermeasures when any abnormality occurs.
- Easy data links between PLCs – The built-in application software allows easy data links between PLCs.
- Compatible with H-PCF Fiber-optic Cables – Possible to use not only the conventional PCF fiber optic cables but also H-PCF (hard-clad fiber) Cables. Since solderless optical connectors can be used, connections on-site have become easier. (For detailed specifications and ordering procedures for H-PCF Cables, contact your OMRON representative.)

Optional Power Supply Module

The SYSMAC Net Module is designed to receive back-up power supply from the Optional Power Supply Module. Should any failure of the SYSMAC Net Module occur, the node bypass function will activate to prevent shutdown of the entire network.

Communication Specifications

ITEM	DESCRIPTION
Communications method	N:N token ring
Transmission method	Manchester code, base band
Data transmission rate	2M bps
Transmission paths	2-conductor fiber optic cable (plastic-clad, crystal core; core dia.: 200 μ m)
Number of nodes	126 max.
Node separation	1 km max.
Message length	2K bytes max.
Send buffer capacity	1 message
Receive buffer capacity	15 messages
Redundancy functions	Automatic loopback Node bypass Self-diagnosis function (by test mode function) Error detection CRC-CCIT generating function = $X^{16}+X^{12}+X^5+1$

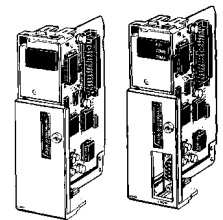

Communications Board
C200HW-COM01
C200HW-COM04-E
(w/RS-232C port)

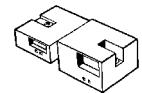

Bus Connection Unit
C200HW-CE001
(for 1 Module)
C200HW-CE002
(for 2 Modules)

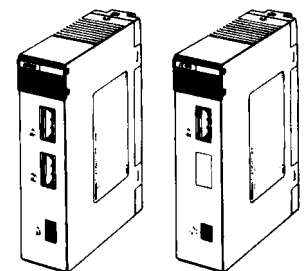

Optional Power Supply Module
C200H-APS01 (for 1 Module)
C200H-APS02 (for 2 Modules)
(Optional Power Supply Adapter required)

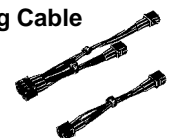

Power Supply Connecting Cable
C200H-CN001
(for 1 Module)
C200H-CN002
(for 2 Modules)

COMMUNICATIONS MODULES

SYSMAC NET LINK MODULE

Network Configuration

The SYSMAC NET consists of one line server and a combination of 126 NSB, NSU, and SYSMAC NET Link Modules max.

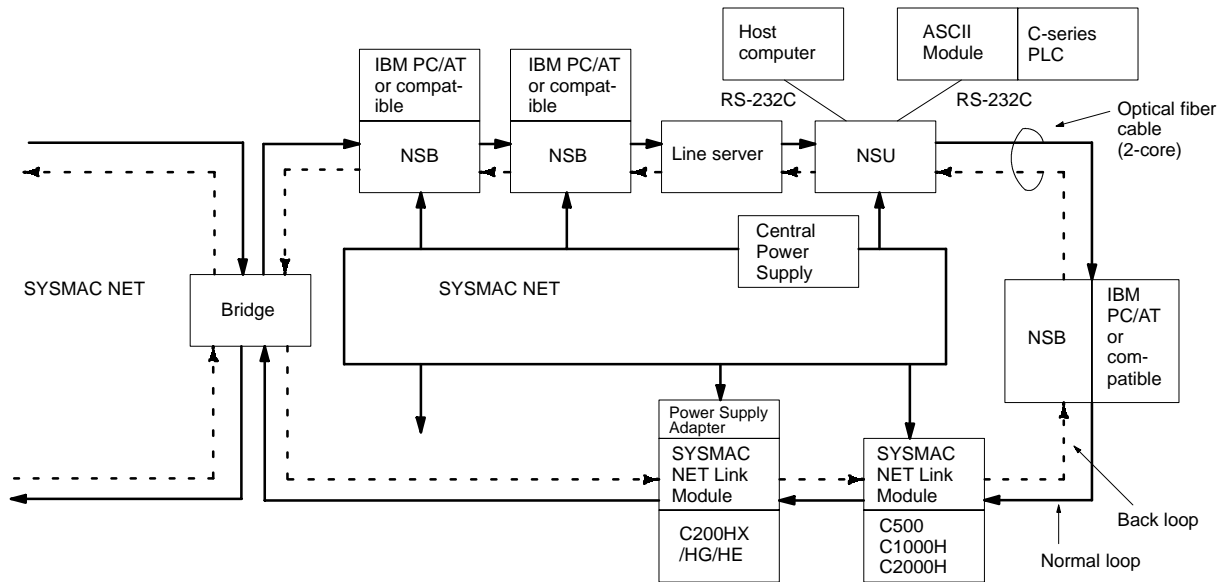

NSB: Network Service Board

NSU: Network Service Module

Bridge: Used for connecting two networks. Up to 20 bridges can be connected in one network provided that it is treated as one node.

SYSMAC NET Link Module: Treated as one node. (It doesn't function as a bridge. When used together with the SYSMAC LINK Module, only a total of two Modules can be connected.)

Specifications

PART NUMBER	C200HS-SNT32
Transmission direction	1:1 Data send/receive 1:N Data send only (no response) Broadcasting data transfer: N:126 max.
Data length	1,000 words max. (2,000 bytes) Only in the same area
Send/Receive data to/from PLC	The command/response format data for data send or that for data receive are sent/received if SEND(90) or RECV(98) has been executed by the program instruction.
Send/Receive data to/from Module other than PLC	Command/Response by data send or data receive
Watchdog timer response	1 s (default) or watchdog timer setting value (10 min, 55.35 s max.)
Internal current consumption	1 A max.
Weight	400 g max.
Manual	W114

COMMUNICATIONS MODULES

SYSMAC NET LINK MODULE

Possible Configurations When Installing SYSMAC NET Link Modules

The following are the possible configurations for installing a SYSMAC NET Module on a C200H α CPU Rack.

One Module Mounted

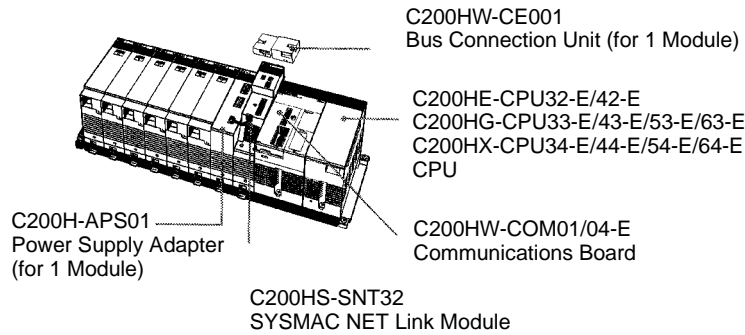

Two Modules Mounted

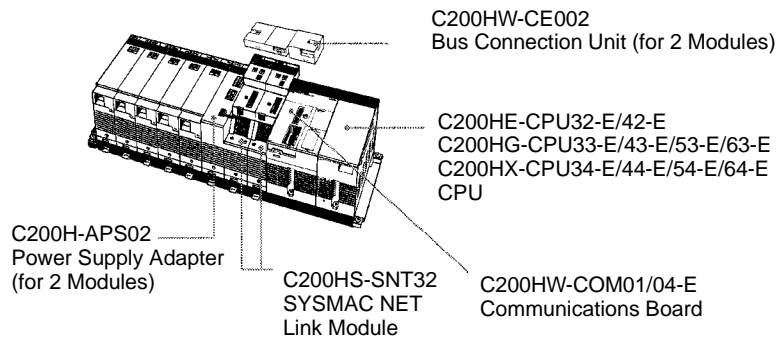

With SYSMAC LINK Module

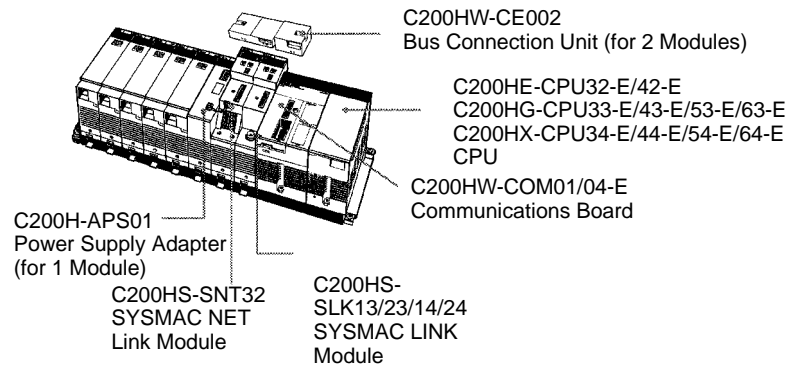

Note: Up to two SYSMAC LINK Modules and the SYSMAC NET Link Module can be mounted to the left of the CPU.

COMMUNICATIONS MODULES

SYSMAC LINK MODULES

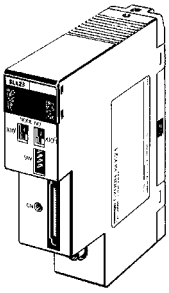

C200HW-SLK23/24
(Coaxial cable)

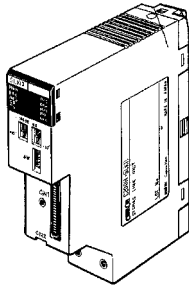

C200HW-SLK13/14
(Fiber-optic)

Communications Board
C200HW-COM01
C200HW-COM04-E
(w/RS-232C port)

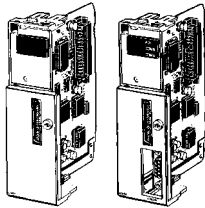

Bus Connection Unit
C200HW-CE001
(for 1 Module)
C200HW-CE002
(for 2 Modules)

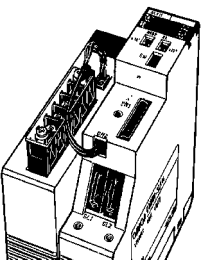
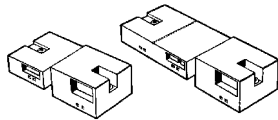

C200H-APS03
Optional Power Supply Module

SYSMAC LINK is a fiber-optic token ring network designed to transfer large amounts of control data in real-time between PLCs. Both coaxial and fiber-optic medias may be used.

The C200H α SYSMAC Link Modules are easily integrated to the C200H α CPU. The Modules connect to the CPU through one of the C200HW-COM01/COM04-E Communications Boards with a C200HW-CE001/CE002 Bus Connector.

Features

- Maximum of 62 SYSMAC LINK Modules – Up to 62 SYSMAC LINK Modules can be connected in one network. In addition, two SYSMAC LINK Modules can be mounted on one PLC, allowing multi-level system configuration.
- Data Modules – The data link capacity is as large as 2,966 words. High-speed and large-capacity data communications are possible using the LR area and DM area.
- Flexible Data Link configuration – Since an optimum data link table can be created for each node (Machine No.) using the SYSMAC Support or SYSWIN, the data link area can be used effectively.
- Event communications – using the SEND and RECV instructions, up to 256 words of data can be sent or received for any node in the network.
- Remote programming or monitoring using the SYSMAC Support Software – Programs can be transferred to any SYSMAC Module within the network and various monitoring operations can be performed for that Module.
- Built-in LSI exclusively for communications – The built-in LSI allows setting of the communication time period between SYSMAC Modules. The control station is automatically switched when any trouble occurs in the data link control station, assuring a highly reliable data link system.

Optional Power Supply Module

The SYSMAC Link Modules are designed to receive back-up power supply from the Optional Power Supply Module. Should any failure of the SYSMAC Link Module occur, the node bypass function will activate to prevent shutdown of the entire network.

Note: Mount the SYSMAC LINK Module to the left of the CPU. The SYSMAC LINK Module cannot be used with the C200HE-CPU11-E.

Specifications

PART NUMBER	C200HW-SLK23/24 (COAXIAL)	C200HW-SLK13/14 (FIBER OPTIC)
Communications method	N:N token ring	
Transmission method	Manchester code, base band	
Transmission path	Bus	Daisy chain
Data transmission rate	2M bps	
Transmission media	Coaxial cable (5C-2V)	Hard-plastic-clad quartz optical fiber cable
Node separation	1 km max.	10 km max. (800 m max. between nodes)
Message length	512 bytes max. (256 words)	
Connectors	BNC (F Adapter)	Full, half-lock press-in connector
Link functions	Data link, data read/write service	
Data link words	C200HW-SLK13/23: 918 words max. C200HW-SLK14/24: 2,966 words max.	
Send buffer capacity	1 message	
Receive buffer capacity	2 messages	
RAS functions	Automatic polling unit backup, self-diagnostics (internode echo tests), failed node bypass (optical systems only), watchdog timer, error (CRC-CCITT) detection = $X^{16}+X^{12}+X^5+1$	
Current consumption	0.8 A max.	
Weight	400 g max.	500 g max.
Manual	W174	

System Configuration

Coaxial Cable System

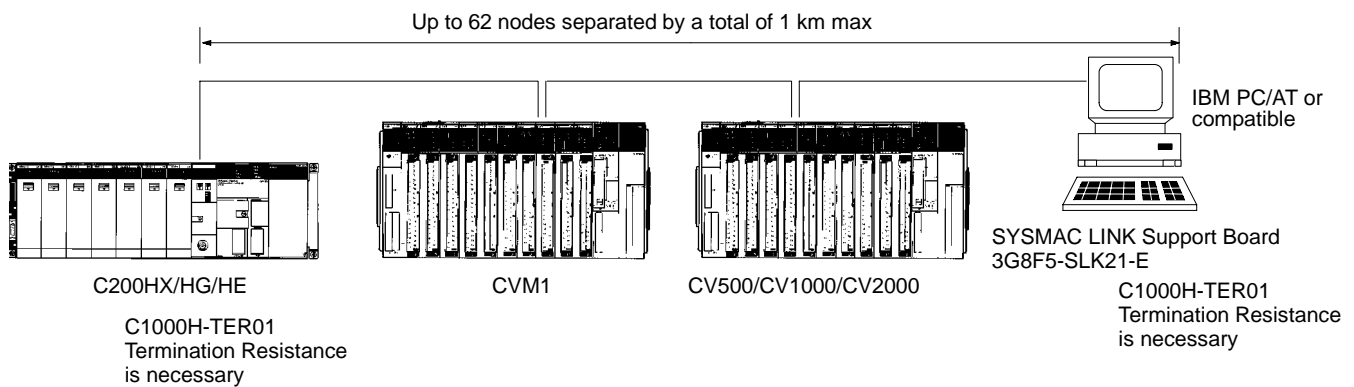

COMMUNICATIONS MODULES

SYSMAC LINK MODULES

Fiber-optic System

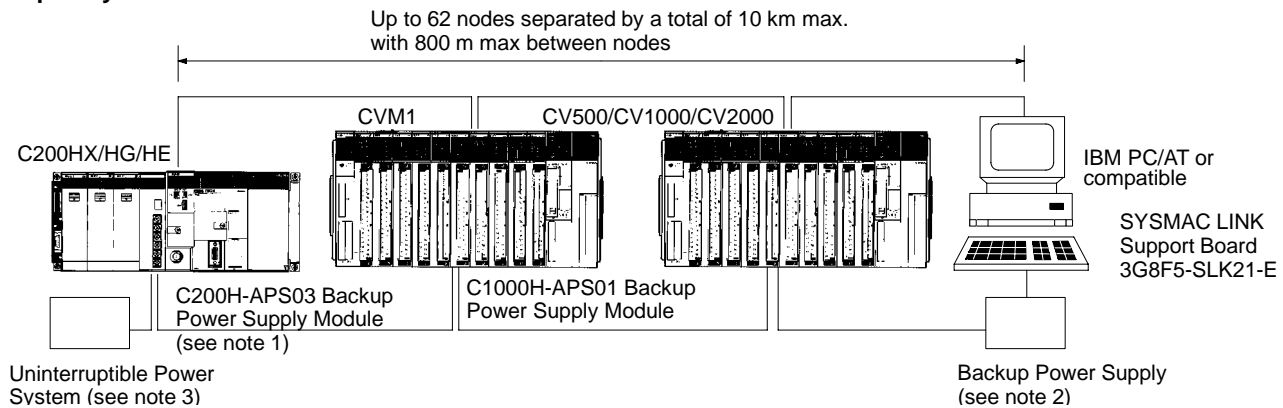

- Note:**
1. The Backup Power Supply is provided with Power Supply Cables (C200H-CN111, C1000H-CN111 for one Module). When supplying power to two Modules simultaneously, order the C200H-CN211 Cable for one Module.
 2. The Backup Power Supply Module for a PLC is different in shape from that for a IBM PC/AT or compatible. Be sure to use an appropriate Power Supply.
 3. The Backup Power Supply must be separated from the main power supply line to the PLC.

Possible Configurations When Installing SYSMAC Link Modules

One Module Mounted

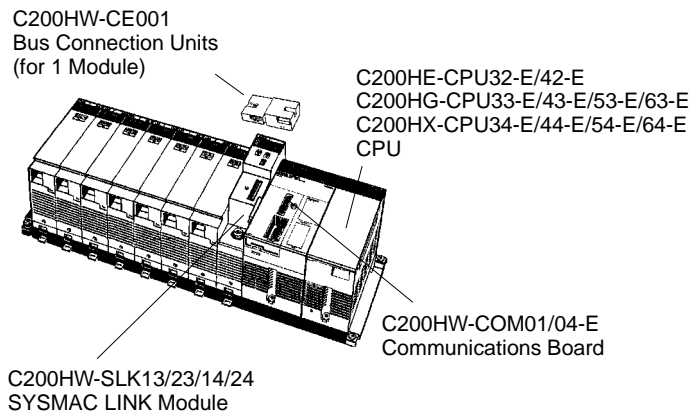

Two Modules Mounted

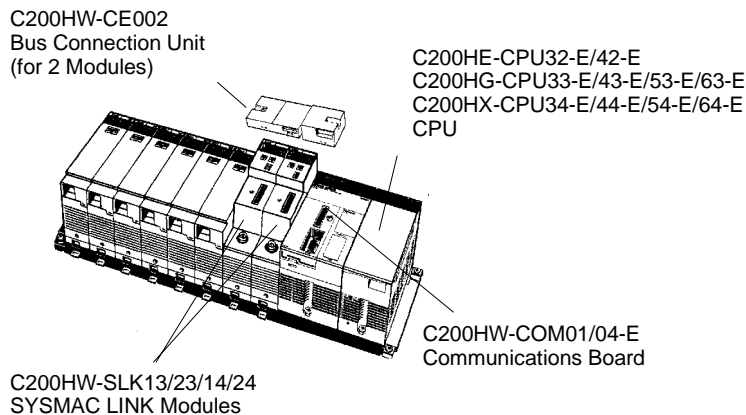

COMMUNICATIONS MODULES

DEVICENET SCANNER MODULE

The DeviceNet Scanner Module for the C200H α allows open communication over DeviceNet networks with Omron and other vendors' I/O products. DeviceNet's open communications protocol allows the greatest flexibility in design of distributed I/O, while at the same time reducing installation costs.

Features

- Dedicated cable saves wiring effort – two nodes are connected through a single dedicated cable, greatly reducing installation costs
- Allows T-type bifurcation, branching, and multi-drop wiring.
- Connects to 50 slaves max. for 1,600-point I/O control possible with the C200HX-, C200HG-, and C200HE-series Master
- Network length of 500 meters max. – possible with a speed of 125K bps
- Communication at 500K bps max. – possible with a network length of 100 m max.
- Conforms to DeviceNet specifications

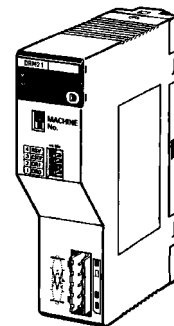

C200HW-DRM21

DeviceNet Communications Specifications

The communications specifications of the DeviceNet Master Module conform to the DeviceNet communications protocol.

ITEM	SPECIFICATIONS			
Baud rate	500K, 250K, or 125K bps (selectable)			
Communications distance	Communications speed (K bps)	Max. network length (m)	Branch length (m)	Total branch length (m)
	500	100 max.	6 max.	39 max.
	250	250 max.		78 max.
125	500 max.	156 max.		
Error control	CRC, node address multiple check, and scan list collation			
Cable	Dedicated cable			

Specifications

PART NUMBER	C200HW-DRM21
Available PLC	C200HX/HG/HE
Max. No. of connecting PLCs	1
Mounting position	Mounted to the CPU or Expansion I/O Rack. (Cannot be mounted to the Slave Rack)
Max. no. of I/O points	1,600
Max. no. of connecting slaves	50
Manual	W267

COMMUNICATIONS MODULES

DEVICENET SCANNER MODULE

System Configuration Example

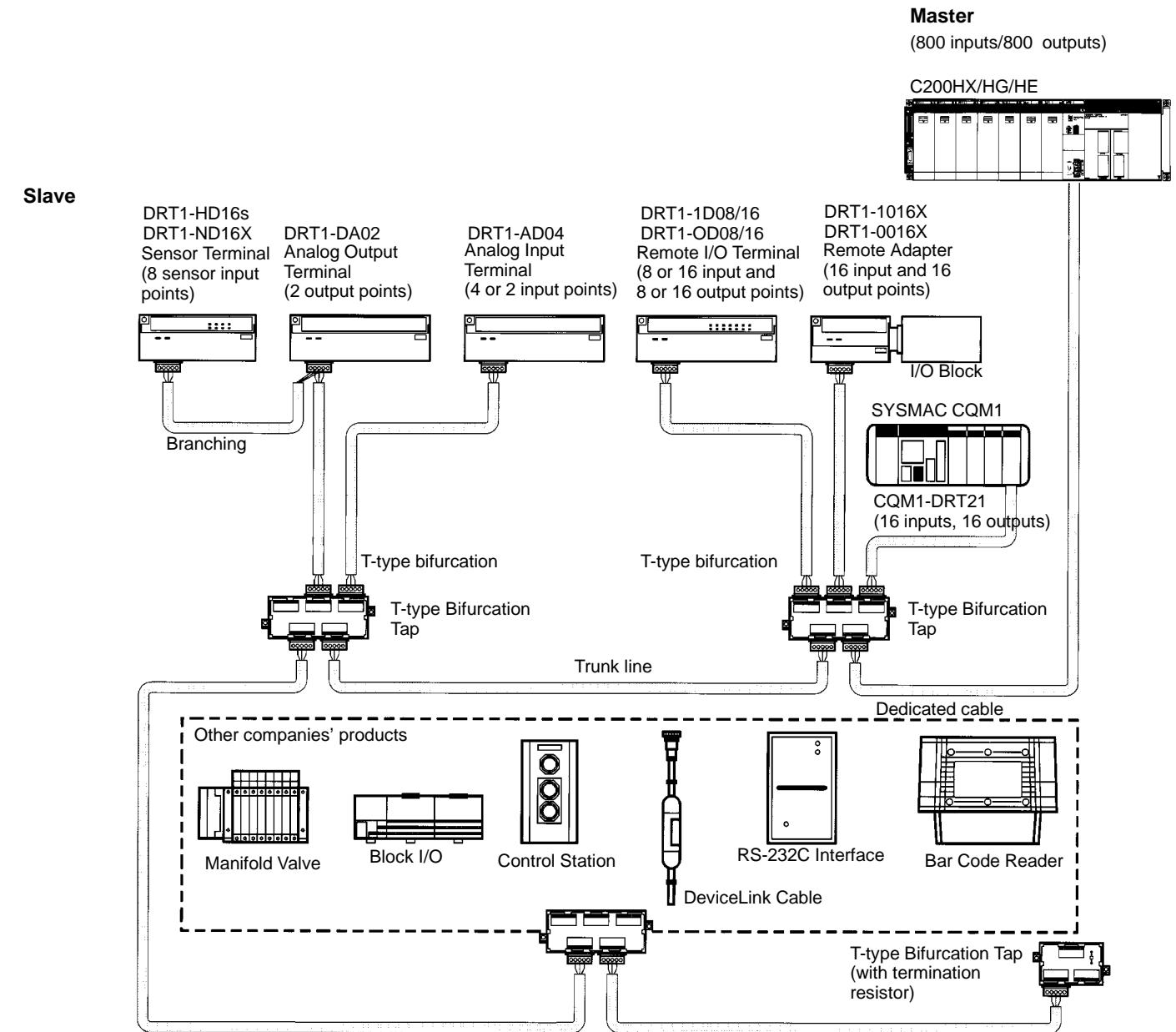

COMMUNICATIONS MODULES

REMOTE I/O MASTER MODULES

The SYSMAC BUS Remote I/O system is ideal for distribution of I/O and other devices at long distances from the CPU. Multiple remote I/O systems can be connected to a single CPU allowing maximum configuration flexibility.

A SYSMAC BUS Remote I/O system consists of a Remote Master and one or more Remote Slave modules. Both small and large rack-style I/O can be mixed in the same remote I/O system. Remote terminal blocks allow for distribution of 8- and 16-point I/O blocks in a wired remote I/O system. Stand-alone fiber-optic I/O modules allow distribution of 8-point I/O blocks in a fiber-optic remote I/O system. I/O Link modules allow connection of a PLC to a fiber-optic remote I/O system. Special link adapters are available for extended distances and mixing media types.

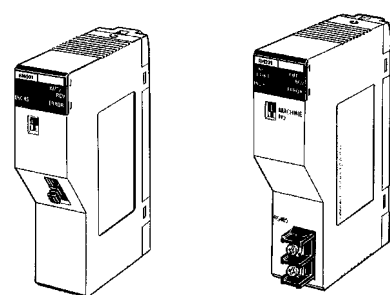

Fiber-optic Master
C200H-RM001-PV1

Wired Master
C200H-RM201

Features

- High-speed distribution with twisted pair wiring (saving both wiring efforts and time) or select fiber-optic cable versions
- Variety of I/O styles and types in a given remote I/O system
- RS-485 communications at 187.5 Kbps
- Connect C200H I/O, C500 I/O, G7 remote I/O terminals, programmable terminals

Note: Remote I/O Master Module cannot be used with a DeviceNet Master Module.

Available Remote I/O Slaves

MODULE		WORDS ALLOCATED	MAX. IN FIBER-OPTIC SYSTEMS	MAX. IN WIRED SYSTEMS	
Remote I/O Slave Modules	C200H Slave Racks	IR 050 to IR 099	5 (any Expansion I/O Racks connected to Slave Racks must be counted as one additional Slave each)	2 (If C200H and C500 Slave Racks are both used under the same Master, compute the total for C200H Slaves, counting each C500 Slave as two C200H Slaves.)	
	C500 Slave Racks				
Fiber-optic I/O Module		IR 200 to IR 231	32	Cannot connect.	
Programmable Terminals			Cannot connect.	8 (4 words allocated to each)	(See note)
I/O Terminals				32 (1 word allocated to each)	
Remote Interfaces				32 (1 word allocated to each)	
CQM1	I/O links created to C200H			8 (4 words allocated to each)	

Note: When using the above Modules in combination, be careful not to allocate the same words.

COMMUNICATIONS MODULES

REMOTE I/O MASTER MODULES

I/O Links to the CQM1

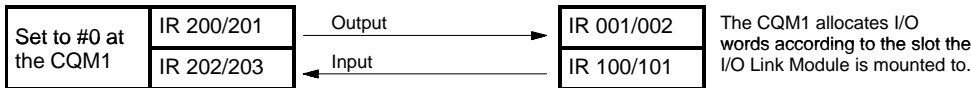
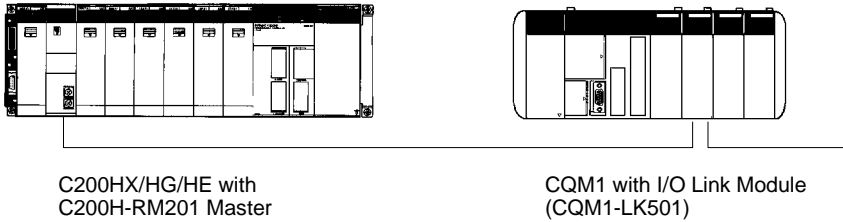

System Configuration

Fiber-optic Remote I/O System

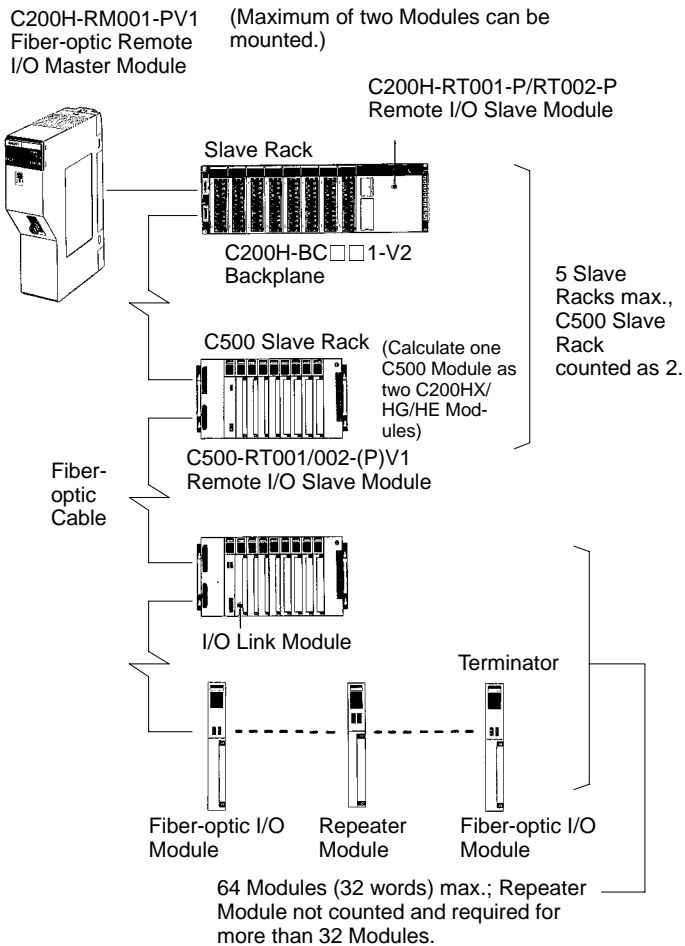

Wired Remote I/O System

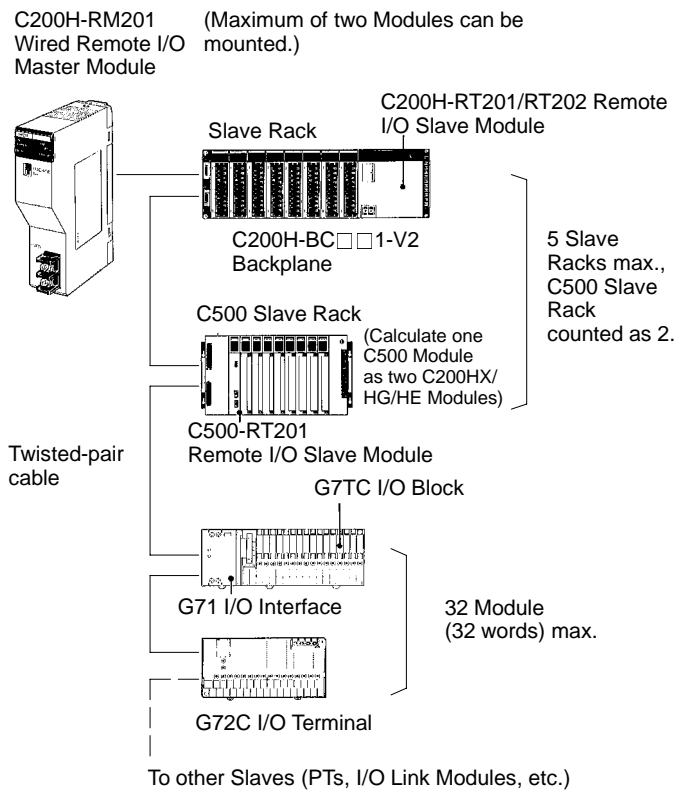

COMMUNICATIONS MODULES

HOST LINK MODULES

Host Link allows any computer or other communications devices to communicate with one (RS-232C), or several (RS-422) Omron PLCs. Multiple system levels can be connected to the same PLC with up to 32 PLCs connected to one computer. Omron's Host Link protocol is well defined and available for custom software driver development and operator interface connection to Omron PLCs. Most major operator interface companies have Host Link interfaces and drivers available. Host Link systems allow SYSWIN Programming Software or SSS to program and monitor any PLC in the system.

When configuring a Host Link system:

- The computer must have one serial port available
- If a fiber-optic, or RS-422 Host Link module is used, Link Adapters must be included in the system

Features

The Host Link protocol is common to all Omron PLCs, including the CPM1, CQM1, C200H, C200HS, C200HE, C200HG, C200HX, C1000H, C2000H, and CV-series PLCs.

- Connect up to 32 PLCs to a single host computer
- Use twisted pair or fiber-optic transmission media

On the Host Link Module side:

- IR area can be read or written
- Programs can be uploaded or downloaded
- Up to two Host Link Modules can be connected to a CPU or Expansion I/O Module. RS-232C, RS-422, and plastic-clad fiber-optic are available
- Host Link Modules can be used in combination (multi-drop) with other C-series Modules
- Host Link Modules can be connected to the Operator Interface Terminal

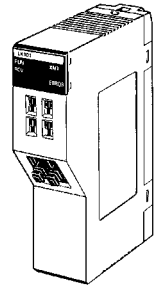

**C200H-LK101-PV1
Host Link Module
(Fiber-optic)**

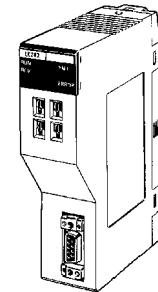

**C200H-LK202-V1
Host Link Module
(RS-422)**

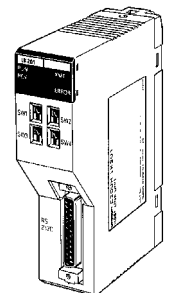

**C200H-LK201-V1
Host Link Module
(RS-232C)**

COMMUNICATIONS MODULES

HOST LINK MODULES

System Configuration

Multilevel Host Link System

The following example illustrates the use of the C200H-LK101-PV1 (fiber-optic) with two personal computers for system monitoring and data loading.

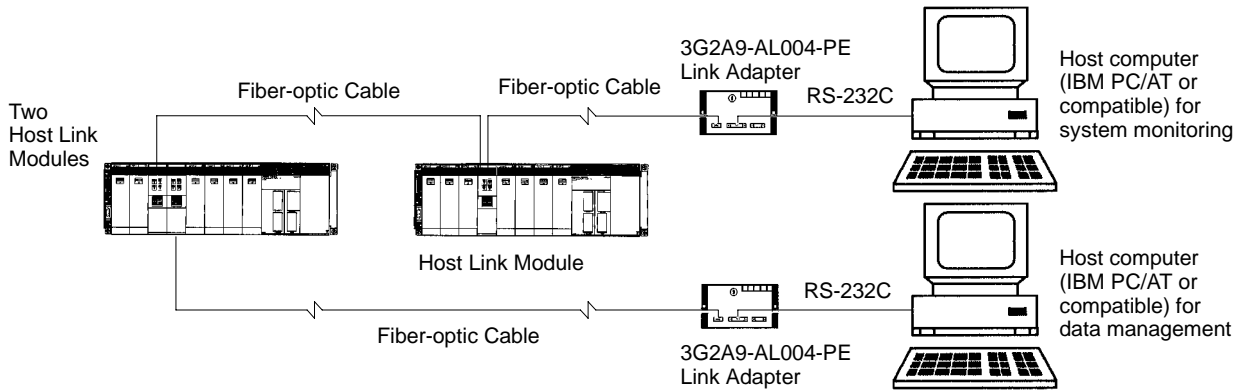

Host Link System with SYSMAC Support Software or SYSWIN

Various functions, such as offline programming or online monitoring, can be developed by connecting to the IBM PC/AT or compatible with the use of SYSMAC Support Software or SYSWIN.

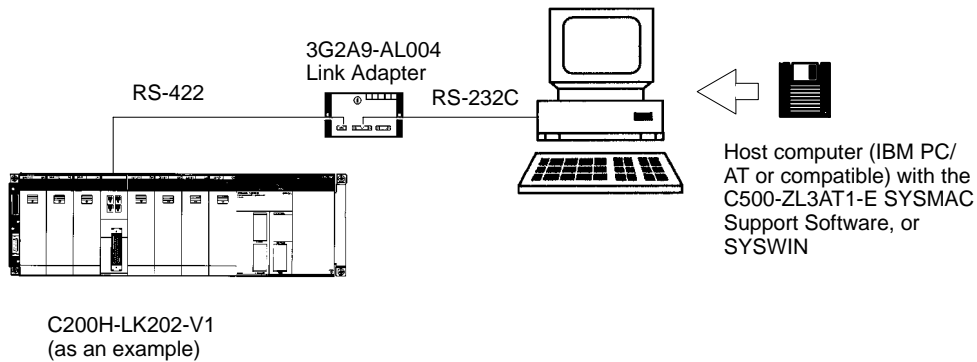

COMMUNICATIONS MODULES

PC LINK MODULES

PC Link is a peer-to-peer communication system allowing high-speed transfer of data between PLCs over long distances. Both small and large rack PLCs can be connected to the same system. Standard Link Adapters are available for fiber-optic media and longer transmission distances. No special programming is required to transfer data, and multi-level systems can be connected to a single PLC.

Features

- High-speed data transfer between up to 32 PLCs
- No special programming required
- Multi-level capability

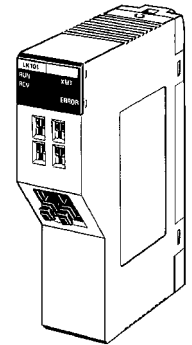

**C200H-LK401
PC Link Module**

Specifications

PART NUMBER	C200H-LK401					
Communication method	2-conductor, half duplex					
Synchronization	HDLC					
Transmission speed	128K bps					
Transmission method	Broadcasting					
Transmission distance	500 m (total cable length in system without optical links, including branch lines)					
Max. no. of PLC Link Modules per System (see note)	PLC of polling unit	Single-level			Multilevel	
	C200HX/HG/HE, C1000H, or C2000H	32			16	
Transmission LR bits	No. of PC Link Modules	2	3 to 4	5 to 8	9 to 16	17 to 32
	C200HX/HG/HE, C1000H, or C2000H	512	256	128	64	32
Transmission time	35 ms max. (for 128 bits with 8 PLC Link Modules)					
Diagnostic functions	CPU watchdog timer, CRC transmission error check					
Interface	RS-485					
Cable used	Shielded twisted pair					
Manual	W135					

Note: Use a 3G2A5-LK009-V1 PLC Link Module when connecting to the C1000H(F) or C2000H.

COMMUNICATIONS MODULES

PC LINK MODULES

PC Link System Hierarchy

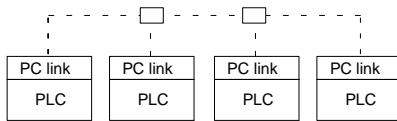

□ Use a Link Adapter.
Use RS-232C, RS-422, or fiber-optic cable depending on application.

Multi-level System (4 Levels Max.)

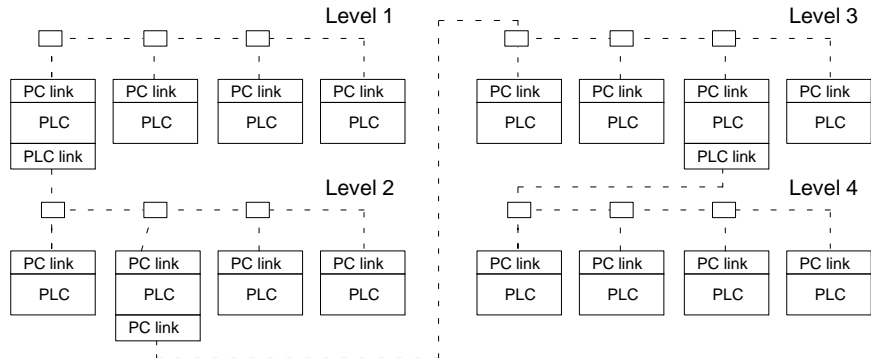

Usage of Link Relay Area

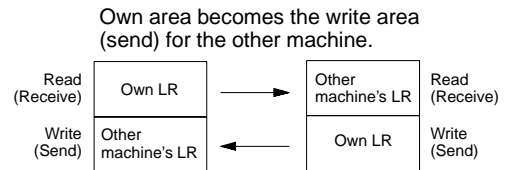
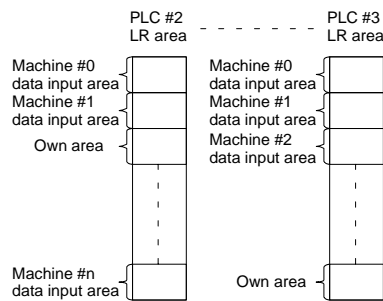
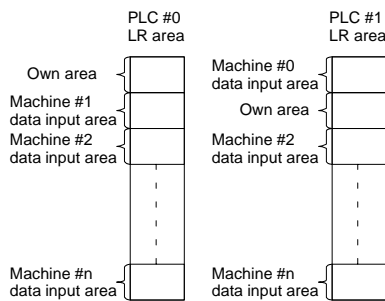

Own area becomes the write area (send) for the other machine.
For example, when inputting data 5232 into LR 00 of machine #0, the data 5232 is output to the LR 00 of machines #1 to #n.

Application Example

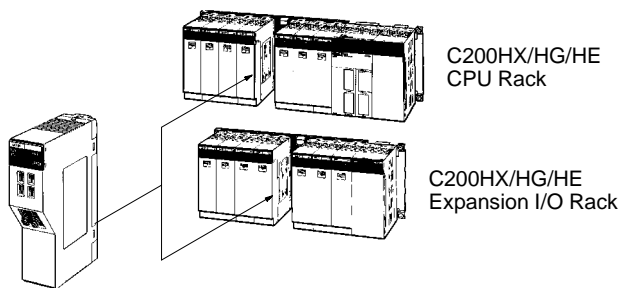

PC Link – offering high-speed peer-to-peer communications between PLCs.

- Up to two PC Link Modules can be connected to the C200HX/HG/HE CPU C200H-LK401 or Expansion I/O Module.
- The PC Link Module is included in the connectable number of Special I/O Modules (10 Modules max.). Although this requires Machine No. setting, it doesn't occupy the IR area or DM area.
- Using the split processing of the PC Link Module, PC Link service can be divided into two, four, or eight parts, preventing any increase in the cycle time.

COMMUNICATIONS

FIBER-OPTIC CABLE AND CONNECTIONS

Omron pioneered the use of fiber-optics for factory floor communications in 1985 by introducing standard fiber-optic interfaces for Remote I/O and all Omron industrial communications networks. Fiber-optic communications offer distinct advantages over conventional wiring, including electrical noise immunity and increased transmission distances.

Recent developments in fiber-optic and communications technology have provided a variety of cost-effective and easy-to-install solutions. Simple field termination, lower cable costs and a variety of fiber-optic cable types allow the effective use of fiber-optic communications in most industrial applications.

Omron offers a variety of standard direct-connect fiber-optic modules for fiber-optic communications. Two types of modules are available: -P suffix types are for use with APF, HPCF and PCF Cable types. Non -P suffix types are for use with HPCF and PCF Cable types. Both of these module types accept the fiber-optic cable directly. No adapter is needed.

All Plastic Fiber (APF)

All Plastic Fiber is ideal for short transmission distances up to 20 meters in remote I/O, or Host Link communications. Field termination requires no special tools or skills. APF requires the use of -P modules. The connectors used with APF are the 3G5A2 connectors.

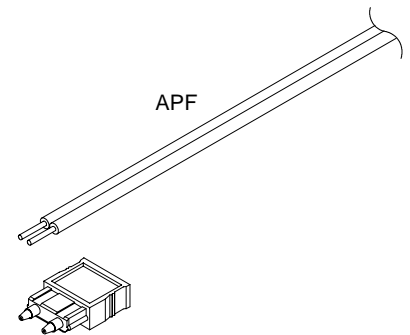

Hard Plastic-clad Fiber (HPCF)

Hard Plastic-clad Fiber has a 200 micron core cable for maximum distances of up to 200 meters without repeaters. It is available in both a zipcord style and a reinforced plastic-jacketed style with stress relief for pulling through conduit. A termination tool kit is required for field terminations. Bulk cable lengths up to 1 km are available. The connectors used with HPCF are the S3200 connectors.

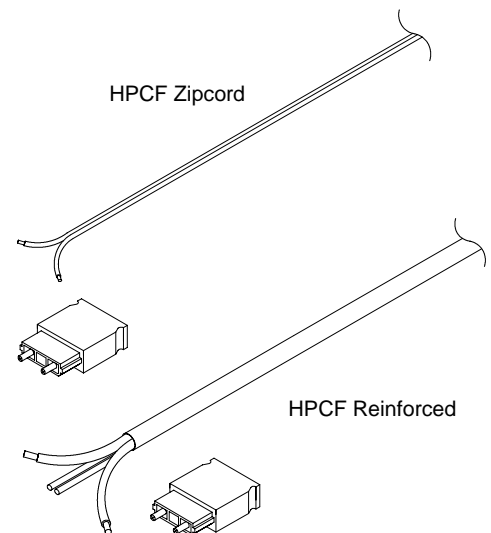

COMMUNICATIONS

FIBER-OPTIC CABLE AND CONNECTIONS

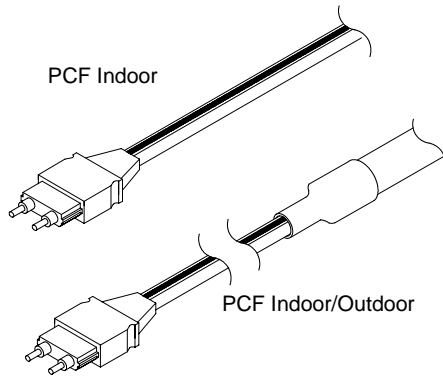

Plastic-clad Fiber (PCF)

Plastic-clad Fiber is a high performance fiber allowing maximum distances of up to 800 meters (0.5 mile) without repeaters. Pre-terminated lengths from 0.1 to 800 meters are available. Connector bodies can be easily removed for running cable through ducts, then re-assembled.

All Glass Crystal Fiber (AGF)

Special cable and configurations are available for longer distance requirements, up to 3 km. The maximum transmission distance with each type of fiber-optic cable is determined by the kind of Remote I/O or Host Link modules used. These modules either have a -P or no -P in the part number. The table below shows maximum transmission distances. Longer distances are possible using standard repeaters.

System Compatibility

The following table shows which Fiber-optic Cable can be used with each system. The table also shows the maximum length of each Cable.

FIBER-OPTIC CABLE	APF	HPCF	PCF
SYSMAC BUS with -P modules	20 m (65 ft.)	100 m (328 ft.)	200 m (656 ft.)
SYSMAC BUS with non -P modules	—	200 m (656 ft.)	800 m (0.5 mile)
SYSMAC WAY with -P modules (C-series only)	20 m (65 ft.)	100 m (328 ft.)	200 m (656 ft.)
SYSMAC WAY with non -P modules (C-series only)	—	200 m (656 ft.)	800 m (0.5 mile)
SYSMAC NET	—	800 m (0.5 mile)	1000 m (0.62 mile)

A Part Number Summary of Fiber-optic Cable and Connectors

Refer to the Standard Parts section of this catalog for an inclusive list of Fiber-optic Connectors and Fiber-optic Cable in three basic types (offering numerous selections within each type).



PROGRAMMING	91
Programming Software	
SSS and SYSWIN	92
Protocol Support Software	94
Programming Peripherals and Cables	97
Programming Instructions	99

PROGRAMMING SOFTWARE

SYSWIN OR SSS

Overview of Software Options

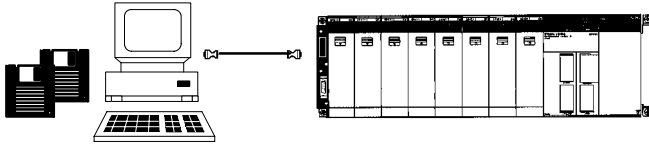

C200Hα CPUs can be programmed using Omron's SYSWIN Programming Software. SYSWIN is a Microsoft Windows®-based programming and documentation application. SYSWIN provides you with an easy and intuitive graphical user interface designed for use with all of Omron's C and CV series PLCs. SYSWIN also offers a comprehensive range of functions for the PLC programmer, from program editing to full symbolic and network debugging.

C200Hα CPUs can also be programmed using Omron's SSS DOS programming packages.

System Information

PLCS SUPPORTED	CPM1, C**K, C**H, CQM1, C200H, C200HS, C500, C1000H, C2000H, C200HE, C200HG, C200HX, CVM1+EV
Communications	SYSMAC NET, SYSMAC LINK, HOST LINK
Computer requirements	486DX2/50
RAM Capacity	2 or 4 MB RAM minimum
Free disk space	8Mb of free hard disk space
Floppy disk drive	3.5" double density
Communication port	1 or 2, with RS-232C port or RS-422
Video	Color VGA or better

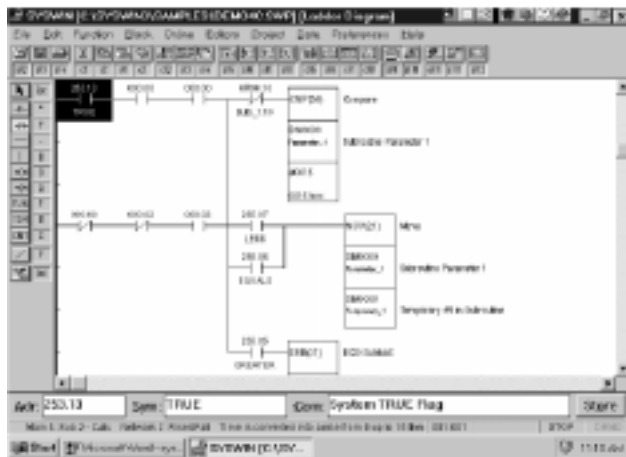

Save time with Easy and Intuitive Programming

SYSWIN provides you with fast and easy programming operations. With simple point and click editing, creating ladder logic is a snap. Not sure about which function to use? SYSWIN provides you with a quick categorization of PLC functions and extensive on-line help. First time users will find it easy to learn while working with Omron's PLCs and Software.

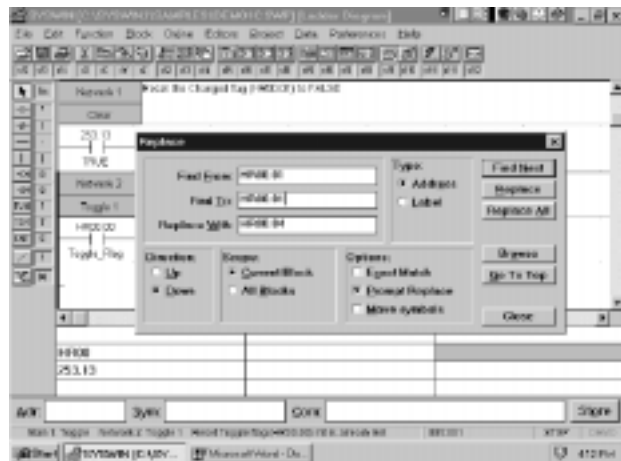

Powerful Editing

Extensive editing features of SYSWIN lets you create and modify programs quickly and easily. Cut and paste library functions let you take advantage of your existing code. In addition, you can easily find and replace program addresses and documentation throughout your program.

Documentation

Need to document your program? SYSWIN gives you lots of room for commenting addresses (30 characters), networks, and blocks of programs (up to 32K per). In addition, managing your documentation is easy using the Address Symbol Editor. With the Address Symbol editor you get all of our internal relays already documented as well as a summary of all addresses used in the program and documentation. Simply select a new address for your program and choose from the documentation. In addition you can sort your documentation by address or symbol.



Extensive Monitoring Tools

SYSWIN programming software let's you monitor bit status, specified I/O status, word content, or Data memory on-line. With the *Data Display*, monitoring large areas of memory is made easy. Different areas of memory can be monitored simultaneously – as well as in different data formats, such as hex, decimal, binary, ASCII, and floating point.



Powerful Cross Reference

SYSWIN's address cross referencer is great tool for debugging your program. With a simple point and click you can view all your addresses, location and usage while also viewing ladder logic. Then simply click on any address and your ladder logic automatically moves to the location of address.



PROGRAMMING SOFTWARE

PROTOCOL SUPPORT SOFTWARE

Overview

The C200HW-COM04-E, C200HW-COM05-E, and C200HW-COM06-E Communication Boards have a protocol macro capability. The Protocol Support Software makes it possible to customize communication sequences by using the protocol macro. The Protocol Support Software supports seven types of standard communications sequences – to either customize or use as they are.

- The conversational-type menu of the Protocol Support Software allows communication sequences to be registered easily.
- The Protocol Support Software allows a maximum of 1,000 communication sequences to be registered, each having 16 steps max.
- Each of the registered communication sequences can include data for the transmission method, link word, monitor period, and response advice method to be used with the registered communication sequence. X-ON and X-OFF flow control, RS and CS flow, modem control, delimiter control and the contention method are supported by the Protocol Support Software.
- Each of the steps can include data for the repetition number, a communication command, communication message, reception matrix, the next process to be executed, and the error processing command to be executed if the step has an execution error.
- Any destination address or communications data set with the Protocol Support Software can include variable N, wildcard, and word call settings. Whenever a step is repeated, the value of variable N in the step will increase by one. Because of this, a message can be transmitted to more than one address continuously, or the table data stored in any word can be transmitted continuously.
- The Protocol Support Software automatically allows transmission of any communication message with an error check code, such as SUN, LRC, or CRC, and data for the length of the communication message. At the destination address of the communication message, the Protocol Support Software allows the checking of the communication message according to the error check code and the data for the length of the communication message so the destination address can receive the communication message correctly.
- The process can be defined with an END, GOTO, NEXT, or ABORT that is executed right after each step is executed with or without any error.
- A maximum of 15 types of expected reception messages can be set with a reception matrix. Each of the expected reception messages can include data that determines the next process to be executed and the error processing command to be executed if there is a message reception error.

Note: Refer to the *Protocol Support Software Operation Manual (W305)* for details.

PROGRAMMING SOFTWARE

PROTOCOL SUPPORT SOFTWARE

System Settings

Set communication conditions according to the application when using the protocol macro for communication. The standard communication conditions are shown here.

ITEM	SPECIFICATIONS
No. of start bits	1
Data length	7 bits
Parity	Even
No. of stop bits	2
Baud rate	9,600 bps

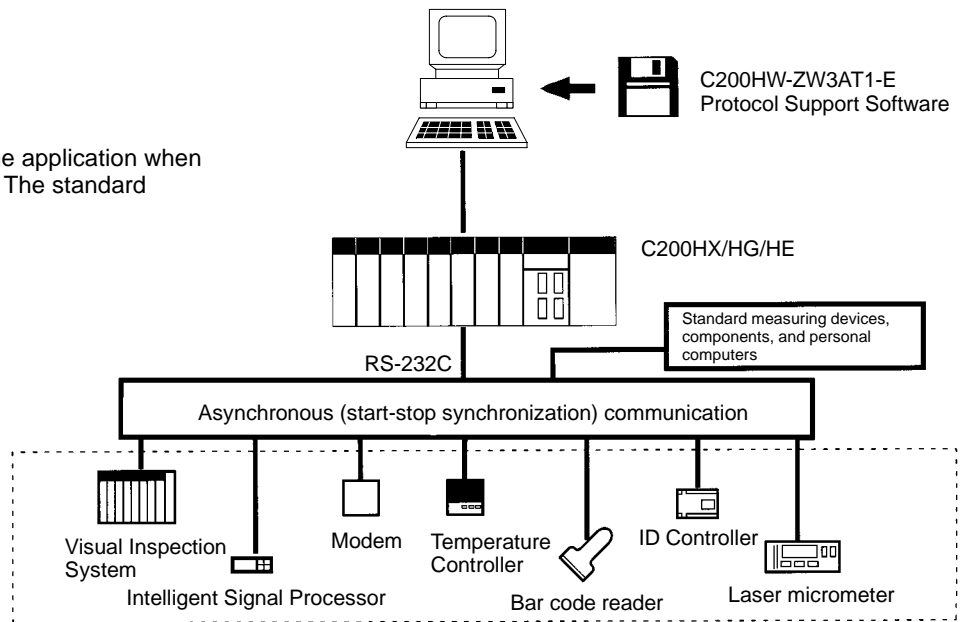

System Configuration

Using the protocol macro, you can customize communications sequences for a variety of communications devices that use RS-232C, RS-422, or RS-485 lines. Refer to the following system configuration.

Configuration of Communication Sequences – A maximum of 1,000 communications sequences (i.e., communications sequences 0 to 999) can be registered, each consisting of 16 steps max.

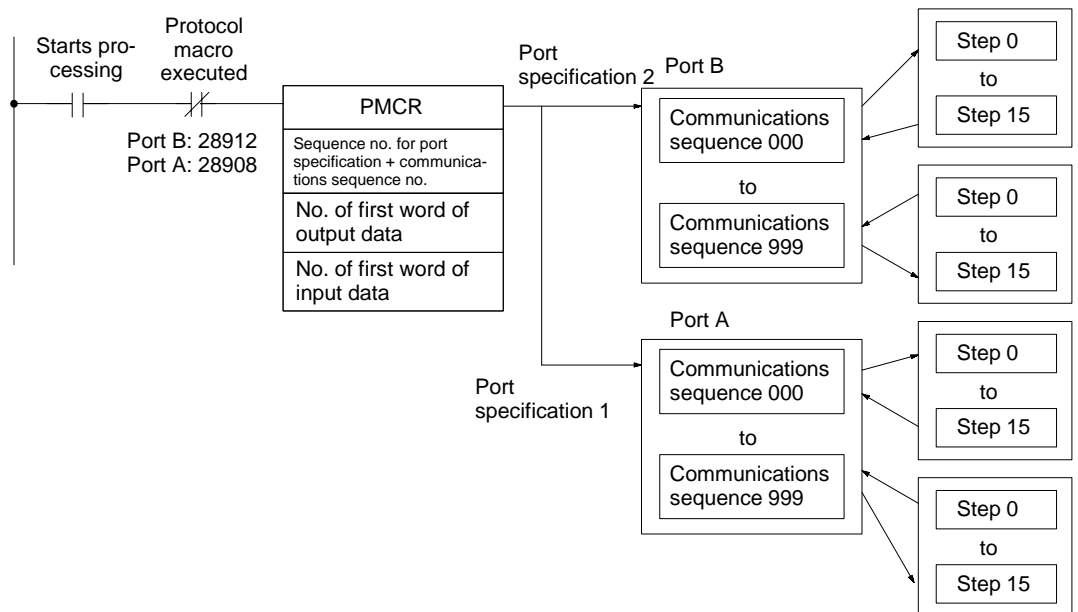

PROGRAMMING SOFTWARE

PROTOCOL SUPPORT SOFTWARE

E5AJ Temperature Controller Connection Example

Connections

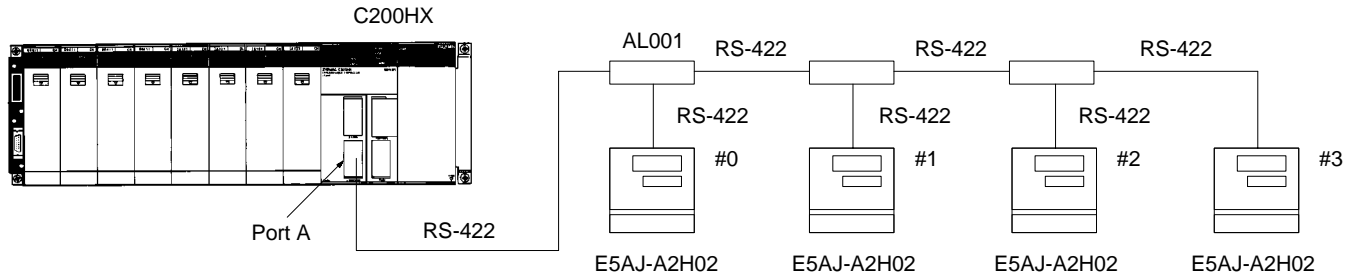

Program Example

In this example, the E5AJ is set to a target value.

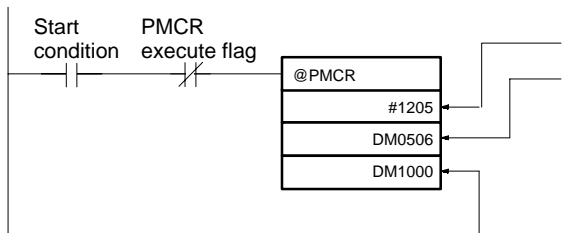

Port A specification with communications sequence 205

Setting Units and Values

DM word	Set data	Meaning
DM 0506	0003	No. of words for transmission data
DM 0507	0003	Unit no.
DM 0508	0085	Target value (85°C)

End Code:

This communications sequence is set to any word because there is no reception data for the communications sequence.

PROGRAMMING PERIPHERALS AND CABLES

OVERVIEW

These are the devices available for programming and diagnostics.

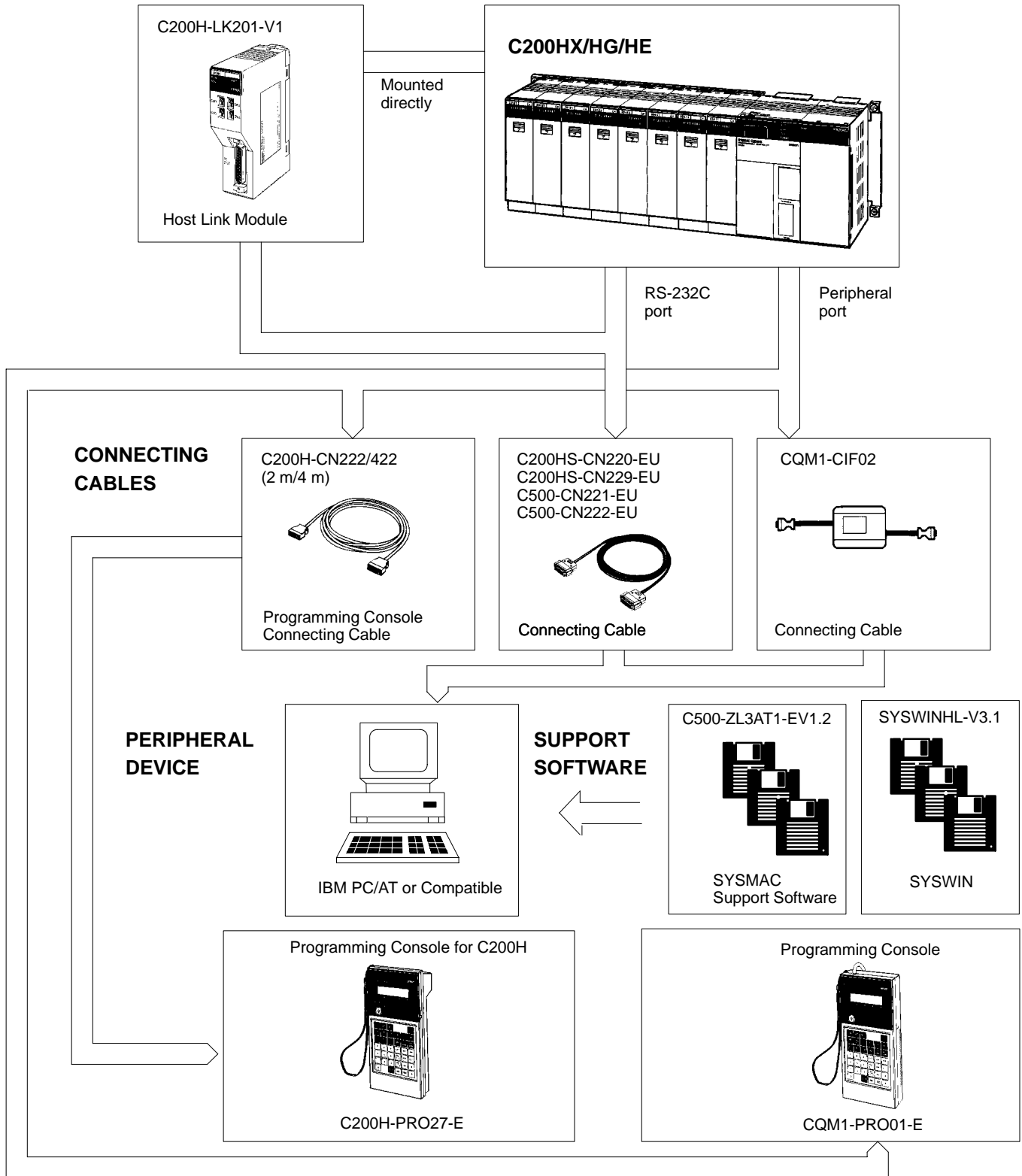

PROGRAMMING PERIPHERALS AND CABLES

OVERVIEW

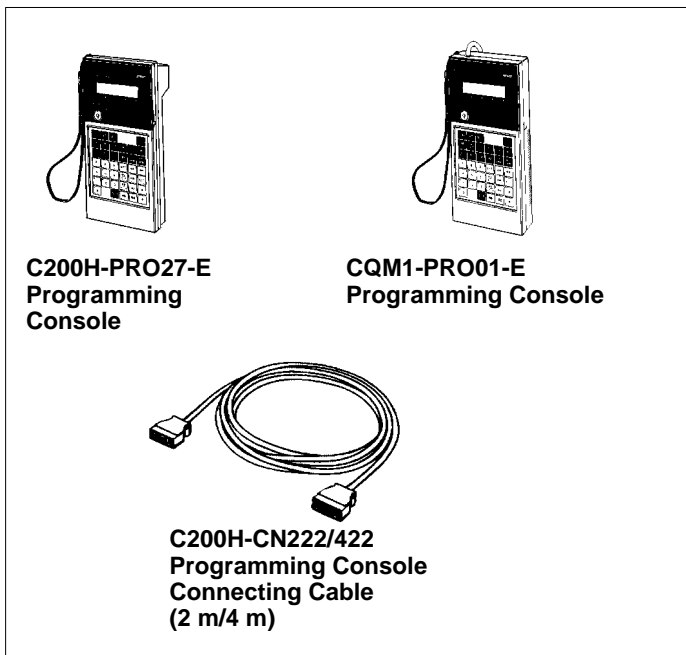

Programming Consoles

There are two programming consoles that can be used with the C200HX/C200HG/C200HE: The C200H-PRO27-E and the CQM1-PRO01-E. The programming console is a complete on-line and off-line programming and monitoring hand-held console. In addition to programming and monitoring with the programming console, users can verify programs, compare and create I/O tables, monitor multiple I/O, force set/reset bits, and choose from run, monitor, debug or program modes.

The C200H-PRO27-E Programming Console connects to the C200HX/C200HG/C200HE CPU peripheral port with C200H-CN222 or C200H-CN422 Connecting Cable (cable purchased separately).

The CQM1-PRO01-E Programming Console comes with a 2 m connecting cable which connects to the C200HX, C200HG, or C200HE CPU peripheral port.

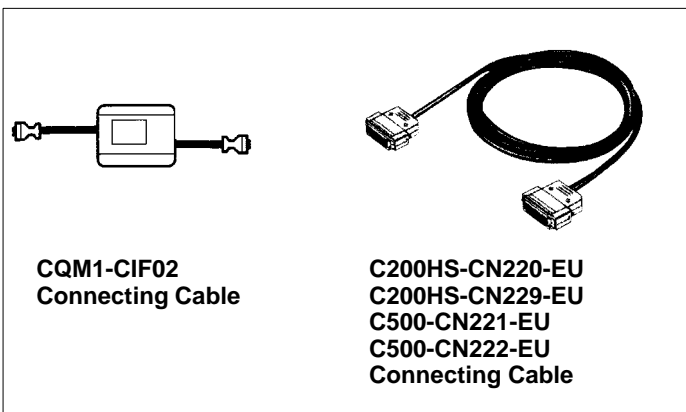

Connecting Cables

There are several cables which allow you to connect a PC to the C200HX/HG/HE for programming and monitoring, using SYSWIN or SSS. The C200HS-CN220-EU (9-pin RS-232C) and the C200HS-CN229-EU (25-pin RS-232C) cables connect a PC to a built-in RS-232C port of the C200HX/HG/HE CPU. The C500-CN221-EU (9-pin RS-232C) and C500-CN222-EU (25-pin RS-232C) cables connect a PC to a rack-mounted C200H-LK201-V1.

PROGRAMMING INSTRUCTIONS

GENERAL INFORMATION AND BASIC INSTRUCTIONS

General Information

- An instruction marked with “@” can be used as a differentiated instruction that will be executed only once each time the instruction executing condition is turned ON.
- An instruction marked with “★” is an expansion instruction. These instructions must be assigned function codes before they can be used.
- An instruction marked with “*” is an expansion instruction. The assigned function code is the default for the C200HX/HG/HE PLC.

Basic Instructions

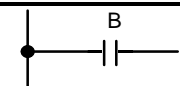
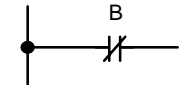
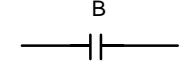
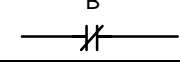
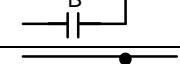
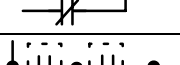
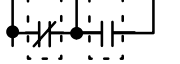
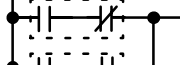
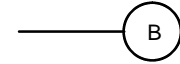
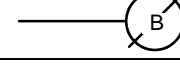
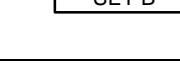
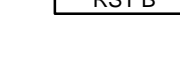
NAME MNEMONIC	SYMBOL	FUNCTION
LOAD LD		Defines the status of bit B as the execution condition for subsequent operations in the instruction line.
LOAD NOT LD NOT		Defines the status of the inverse of bit B as the execution condition for subsequent operations in the instruction line.
AND AND		Logically ANDs the status of the designated bit with the current execution condition.
AND NOT AND NOT		Logically ANDs the inverse of the designated bit with the current execution condition.
OR OR		Logically ORs the status of the designated bit with the current execution condition.
OR NOT OR NOT		Logically ORs the inverse of the designated bit with the execution condition.
AND LOAD AND LD		Logically ANDs the resultant execution conditions of the preceding logic blocks.
OR LOAD OR LD		Logically ORs the resultant execution conditions of the preceding logic blocks.
OUTPUT OUT		Turns ON B for an ON execution condition; turns OFF B for an OFF execution condition.
OUTPUT NOT OUT NOT		Turns OFF B for an ON execution condition; turns ON B for an OFF execution condition.
SET SET		Turns the operand bit OFF when the execution condition is ON, and does not affect the status of the operand bit when the execution condition is OFF.
RESET RSET		Turns the operand bit ON when the execution condition is ON, and does not affect the status of the operand bit when the execution condition is OFF.

- An instruction marked with “@” can be used as a differentiated instruction that will be executed only once each time the instruction executing condition is turned ON.
- An instruction marked with “★” is an expansion instruction. These instructions must be assigned function codes before they can be used.
- An instruction marked with “*” is an expansion instruction. The assigned function code is the default for the C200HX/HG/HE PLC.

PROGRAMMING INSTRUCTIONS

BASIC INSTRUCTIONS (CONTINUED)

NAME MNEMONIC	SYMBOL	FUNCTION
COUNTER CNT		A decrementing counter. SV: 0 to 9999; CP: count pulse; R: reset input. The TC bit is entered as a constant.
REVERSIBLE COUNTER CNTR (12)		Increases or decreases the PV by one whenever the increment input (II) or decrement input (DI) signals, respectively, go from OFF to ON. SV: 0 to 9999; R: reset input.
TIMER TIM		ON-delay (decrementing) timer operation. Set value: 000.0 to 999.9 s.
TOTALIZING TIMER TTIM(87) *		Creates a totalizing timer.
HIGH-SPEED TIMER TIMH(15)		A high-speed, ON-delay (decrementing) timer. SV: 00.02 to 99.99 s. The TC bit is entered as a constant.
END END(01)		Required at the end of each program. Instructions located after END(01) will not be executed.
INTERLOCK IL(02) INTERLOCK CLEAR ILC(03)		Creates interlocks used to control execution of program sections. The entire section is reset when execution is completed.
JUMP JMP(04) JUMP END JME(05)		JUMP transfer program execution to the JUMP END with the same number.
KEEP KEEP(11)		Defines a bit (B) as a latch, controlled by the set (S) and reset (R) inputs.
NO OPERATION NOP(00)	None	Nothing is executed and program operation moves to the next instruction.
DIFFERENTIATE UP DIFU(13)		DIFU(13) turns ON the designated bit (B) for one cycle on reception of the leading (rising) edge of the input signal.
DIFFERENTIATE DOWN DIFD(14)		DIFD(14) turns ON the bit for one cycle on reception of the trailing (falling) edge.

- An instruction marked with "@" can be used as a differentiated instruction that will be executed only once each time the instruction executing condition is turned ON.
- An instruction marked with "★" is an expansion instruction. These instructions must be assigned function codes before they can be used.
- An instruction marked with "※" is an expansion instruction. The assigned function code is the default for the C200HX/HG/HE PLC.

PROGRAMMING INSTRUCTIONS

DATA CONVERSION INSTRUCTIONS

NAME MNEMONIC	SYMBOL	FUNCTION				
BCD-TO- BINARY (@)BIN(23)	<table border="1"> <tr><td>BIN(23)</td></tr> <tr><td>S</td></tr> <tr><td>R</td></tr> </table>	BIN(23)	S	R	<p>Converts 4-digit, BCD data in source word (S) into 16-bit binary data, and outputs converted data to result word (R).</p>	
BIN(23)						
S						
R						
DOUBLE BCD-TO-DOUBLE BINARY (@)BINL(58)	<table border="1"> <tr><td>BINL(58)</td></tr> <tr><td>S</td></tr> <tr><td>R</td></tr> </table>	BINL(58)	S	R	<p>Converts the BCD value of the two source words (S: starting word) into binary and outputs the converted data to the two result words (R: starting word).</p>	
BINL(58)						
S						
R						
BINARY-TO- BCD (@)BCD(24)	<table border="1"> <tr><td>BCD(24)</td></tr> <tr><td>S</td></tr> <tr><td>R</td></tr> </table>	BCD(24)	S	R	<p>Converts binary data in source word (S) into BCD, and outputs converted data to result word (R).</p>	
BCD(24)						
S						
R						
DOUBLE BINARY-TO-DOUBLE BCD (@)BCDL(59)	<table border="1"> <tr><td>BCDL(59)</td></tr> <tr><td>S</td></tr> <tr><td>R</td></tr> </table>	BCDL(59)	S	R	<p>Converts the binary value of the two source words (S: starting word) into eight digits of BCD data, and outputs the converted data to the two result words.</p>	
BCDL(59)						
S						
R						
BIT COUNTER (@)BCNT(67) *	<table border="1"> <tr><td>BCNT(67)</td></tr> <tr><td>N</td></tr> <tr><td>SB</td></tr> <tr><td>R</td></tr> </table>	BCNT(67)	N	SB	R	<p>Counts the number of ON bits in one or more words.</p>
BCNT(67)						
N						
SB						
R						

- An instruction marked with "@" can be used as a differentiated instruction that will be executed only once each time the instruction executing condition is turned ON.
- An instruction marked with "★" is an expansion instruction. These instructions must be assigned function codes before they can be used.
- An instruction marked with "※" is an expansion instruction. The assigned function code is the default for the C200HX/HG/HE PLC.

PROGRAMMING INSTRUCTIONS

DATA CONVERSION INSTRUCTIONS (CONTINUED)

NAME MNEMONIC	SYMBOL	FUNCTION				
4-TO-16 DECODER (@)MLPX(76)	<table border="1"> <tr><td>MLPX(76)</td></tr> <tr><td>S</td></tr> <tr><td>Di</td></tr> <tr><td>R</td></tr> </table>	MLPX(76)	S	Di	R	<p>Converts up to four hexadecimal digits in the source word (S), into decimal values from 0 to 15, and turns ON the corresponding bit(s) in the result word(s) (R).</p>
MLPX(76)						
S						
Di						
R						
16-TO-4 ENCODER (@)DMPX(77)	<table border="1"> <tr><td>DMPX(77)</td></tr> <tr><td>S</td></tr> <tr><td>R</td></tr> <tr><td>Di</td></tr> </table>	DMPX(77)	S	R	Di	<p>Determines the position of the leftmost ON bit in the source word(s) (starting word: S) and turns ON the corresponding bit(s) in the specified digit of the result word (R).</p>
DMPX(77)						
S						
R						
Di						
7-SEGMENT DECODER (@)SDEC(78)	<table border="1"> <tr><td>SDEC(78)</td></tr> <tr><td>S</td></tr> <tr><td>Di</td></tr> <tr><td>D</td></tr> </table>	SDEC(78)	S	Di	D	<p>Converts hexadecimal values from the source word (S) into 7-segment display data. Results are placed in consecutive half-words, starting at the first destination word (D)</p>
SDEC(78)						
S						
Di						
D						
ASCII CONVERT (@)ASC(86)	<table border="1"> <tr><td>ASC(86)</td></tr> <tr><td>S</td></tr> <tr><td>Di</td></tr> <tr><td>D</td></tr> </table>	ASC(86)	S	Di	D	<p>Converts hexadecimal digits from the source word (S) into 8-bit ASCII values, starting at leftmost or rightmost half of the starting destination word (D).</p>
ASC(86)						
S						
Di						
D						
2'S COMPLEMENT (@)NEG ★	<table border="1"> <tr><td>NEG(--)</td></tr> <tr><td>S</td></tr> <tr><td>R</td></tr> <tr><td>---</td></tr> </table>	NEG(--)	S	R	---	<p>Converts the four-digit hexadecimal content of the source word to its 2's complement and outputs the result to R.</p>
NEG(--)						
S						
R						

DOUBLE 2'S COMPLEMENT (@)NEGL ★	<table border="1"> <tr><td>NEGL(--)</td></tr> <tr><td>S</td></tr> <tr><td>R</td></tr> <tr><td>---</td></tr> </table>	NEGL(--)	S	R	---	<p>Converts the eight-digit hexadecimal content of the source words to its 2's complement and outputs the result to R and R+1.</p>
NEGL(--)						
S						
R						

- An instruction marked with "@" can be used as a differentiated instruction that will be executed only once each time the instruction executing condition is turned ON.
- An instruction marked with "★" is an expansion instruction. These instructions must be assigned function codes before they can be used.
- An instruction marked with "⌘" is an expansion instruction. The assigned function code is the default for the C200HX/HG/HE PLC.

PROGRAMMING INSTRUCTIONS

DATA CONVERSION INSTRUCTIONS (CONTINUED)

NAME MNEMONIC	SYMBOL	FUNCTION
ASCII-TO-HEXADECIMAL (@)HEX ★		Converts ASCII data to hexadecimal data.
LINE (@)LINE(63)		Fetches data from the same numbered bit (C) in 16 consecutive words (where S is the address of the first source word), and creates a 4-digit word with them.
LINE-TO-COLUMN (@)COLM(64) *		Places bit data from the source word (S), consecutively into the same numbered bits of the 16 consecutive destination words.
HOURS-TO-SECONDS (@)SEC(65) *		Converts a time given in hours/minutes/seconds (S and S+1) to an equivalent time in seconds only (R and R+1).
SECONDS-TO-HOURS (@)HMS(66) *		Converts a time given in seconds (S and S+1) to an equivalent time in hours/minutes/seconds (R and R+1).
ARITHMETIC PROCESS (@)APR(69) *		Calculates the cosine, or sine of the given degree value, or determines the y-coordinate of the given x value in a previously established line graph.

- An instruction marked with "@" can be used as a differentiated instruction that will be executed only once each time the instruction executing condition is turned ON.
- An instruction marked with "★" is an expansion instruction. These instructions must be assigned function codes before they can be used.
- An instruction marked with "*" is an expansion instruction. The assigned function code is the default for the C200HX/HG/HE PLC.

PROGRAMMING INSTRUCTIONS

SPECIAL PROCESSING INSTRUCTIONS

NAME MNEMONIC	SYMBOL	FUNCTION																									
TRACE MEMORY SAMPLING TRSM(45)	— <table border="1" style="display: inline-table;"><tr><td>TRSM(45)</td></tr></table>	TRSM(45)	Initiates data tracing.																								
TRSM(45)																											
DISPLAY MESSAGE (@)MSG(46)	— <table border="1" style="display: inline-table;"><tr><td>MSG(46)</td></tr><tr><td>FM</td></tr></table>	MSG(46)	FM	Displays eight words of ASCII code, starting from FM, on the Programming Console or GPC. <div style="text-align: center;"> <p>FM <table border="1" style="display: inline-table;"><tr><td>A</td><td>B</td></tr><tr><td>C</td><td>D</td></tr></table></p> <p style="text-align: center;">↓</p> <p>FM+7 <table border="1" style="display: inline-table;"><tr><td>D</td><td>P</td></tr></table></p> <p style="text-align: center;">↓</p> <p>ABCD.....DP</p> </div>	A	B	C	D	D	P																	
MSG(46)																											
FM																											
A	B																										
C	D																										
D	P																										
LONG MESSAGE (@)LMSG(47) ✱	— <table border="1" style="display: inline-table;"><tr><td>LMSG(47)</td></tr><tr><td>S</td></tr><tr><td>D</td></tr><tr><td>---</td></tr></table>	LMSG(47)	S	D	---	Outputs a 32-character message to either a Programming Console, or a device connected via the RS-232C interface. The output message must be in ASCII beginning at address S.																					
LMSG(47)																											
S																											
D																											

SCALING (@)SCL ★	— <table border="1" style="display: inline-table;"><tr><td>SCL(--)</td></tr><tr><td>S</td></tr><tr><td>P1</td></tr><tr><td>R</td></tr></table>	SCL(--)	S	P1	R	Performs a scaling conversion on the calculated value.																					
SCL(--)																											
S																											
P1																											
R																											
DATA SEARCH (@)SRCH ★	— <table border="1" style="display: inline-table;"><tr><td>SRCH(--)</td></tr><tr><td>N</td></tr><tr><td>R₁</td></tr><tr><td>C</td></tr></table>	SRCH(--)	N	R ₁	C	Searches the specified range of memory for the specified data. Outputs the word address(es) of words in the range that contain the data.																					
SRCH(--)																											
N																											
R ₁																											
C																											
FIND MAXIMUM (@)MAX ★	— <table border="1" style="display: inline-table;"><tr><td>MAX(--)</td></tr><tr><td>C</td></tr><tr><td>R₁</td></tr><tr><td>D</td></tr></table>	MAX(--)	C	R ₁	D	Finds the maximum value in specified data area and outputs that value to another word.																					
MAX(--)																											
C																											
R ₁																											
D																											
FIND MINIMUM (@)MIN ★	— <table border="1" style="display: inline-table;"><tr><td>MIN(--)</td></tr><tr><td>C</td></tr><tr><td>R₁</td></tr><tr><td>D</td></tr></table>	MIN(--)	C	R ₁	D	Finds the minimum value in specified data area and outputs that value to another word.																					
MIN(--)																											
C																											
R ₁																											
D																											
SUM (@)SUM ★	— <table border="1" style="display: inline-table;"><tr><td>SUM(--)</td></tr><tr><td>C</td></tr><tr><td>R₁</td></tr><tr><td>D</td></tr></table>	SUM(--)	C	R ₁	D	Computes the sum of the contents of the words in the specified range of memory. <table style="margin-left: auto; margin-right: auto;"> <thead> <tr> <th></th> <th>MSB</th> <th>LSB</th> </tr> </thead> <tbody> <tr><td>R₁</td><td>1</td><td>2</td></tr> <tr><td>R₁+1</td><td>3</td><td>4</td></tr> <tr><td>R₁+2</td><td>5</td><td>6</td></tr> <tr><td>R₁+3</td><td>7</td><td>8</td></tr> <tr><td>⋮</td><td>⋮</td><td>⋮</td></tr> <tr><td>⋮</td><td>⋮</td><td>⋮</td></tr> </tbody> </table>		MSB	LSB	R ₁	1	2	R ₁ +1	3	4	R ₁ +2	5	6	R ₁ +3	7	8	⋮	⋮	⋮	⋮	⋮	⋮
SUM(--)																											
C																											
R ₁																											
D																											
	MSB	LSB																									
R ₁	1	2																									
R ₁ +1	3	4																									
R ₁ +2	5	6																									
R ₁ +3	7	8																									
⋮	⋮	⋮																									
⋮	⋮	⋮																									

- An instruction marked with "@" can be used as a differentiated instruction that will be executed only once each time the instruction executing condition is turned ON.
- An instruction marked with "★" is an expansion instruction. These instructions must be assigned function codes before they can be used.
- An instruction marked with "✱" is an expansion instruction. The assigned function code is the default for the C200HX/HG/HE PLC.

PROGRAMMING INSTRUCTIONS

SPECIAL PROCESSING INSTRUCTIONS (CONTINUED)

NAME MNEMONIC	SYMBOL	FUNCTION																						
FRAME CHECKSUM (@)FCS ★	<table border="1"> <tr><td>FCS(--)</td></tr> <tr><td>C</td></tr> <tr><td>R₁</td></tr> <tr><td>D</td></tr> </table>	FCS(--)	C	R ₁	D	Checks for errors in data transmitted by a Host Link command. <table border="1" style="margin-left: 100px;"> <tr><td colspan="3" style="text-align: center;">MSB LSB</td></tr> <tr><td>R₁</td><td>1</td><td>2</td></tr> <tr><td>R₁+1</td><td>3</td><td>4</td></tr> <tr><td>R₁+2</td><td>5</td><td>6</td></tr> <tr><td>R₁+3</td><td>7</td><td>8</td></tr> <tr><td>⋮</td><td>⋮</td><td>⋮</td></tr> </table>	MSB LSB			R ₁	1	2	R ₁ +1	3	4	R ₁ +2	5	6	R ₁ +3	7	8	⋮	⋮	⋮
FCS(--)																								
C																								
R ₁																								
D																								
MSB LSB																								
R ₁	1	2																						
R ₁ +1	3	4																						
R ₁ +2	5	6																						
R ₁ +3	7	8																						
⋮	⋮	⋮																						
AVERAGE VALUE (@)AVG ★	<table border="1"> <tr><td>AVG(--)</td></tr> <tr><td>S</td></tr> <tr><td>N</td></tr> <tr><td>D</td></tr> </table>	AVG(--)	S	N	D	Adds the specified number of hexadecimal words and computes the mean value. Rounds off to 4 digits past the decimal point.																		
AVG(--)																								
S																								
N																								
D																								
FAILURE POINT DETECTION FPD ★	<table border="1"> <tr><td>FPD(--)</td></tr> <tr><td>C</td></tr> <tr><td>T</td></tr> <tr><td>D</td></tr> </table>	FPD(--)	C	T	D	Finds errors within an instruction block.																		
FPD(--)																								
C																								
T																								
D																								
PID CONTROL PID ★	<table border="1"> <tr><td>PID(--)</td></tr> <tr><td>S</td></tr> <tr><td>C</td></tr> <tr><td>D</td></tr> </table>	PID(--)	S	C	D	PID control is performed according to the operand and PID parameters that are preset.																		
PID(--)																								
S																								
C																								
D																								

- An instruction marked with "@" can be used as a differentiated instruction that will be executed only once each time the instruction executing condition is turned ON.
- An instruction marked with "★" is an expansion instruction. These instructions must be assigned function codes before they can be used.
- An instruction marked with "※" is an expansion instruction. The assigned function code is the default for the C200HX/HG/HE PLC.

PROGRAMMING INSTRUCTIONS





DATA SHIFTING INSTRUCTIONS

NAME MNEMONIC	SYMBOL	FUNCTION
SHIFT REGISTER SFT(10)		<p>Creates a bit shift register for data from the starting word (St) through to the ending word (E).</p>
REVERSIBLE SHIFT REGISTER (@)SFTR(84)		<p>Shifts bits in the specified words either left or right. Starting (St) and ending words (E) must be specified.</p>
ASYNCHRONOUS SHIFT REGISTER (@)ASFT(17) *		<p>Creates and controls a reversible non-synchronous word shift register between St and E. Exchanges the content of a word containing zero with the content of either the preceding or following word, depending on the shift direction.</p>
WORD SHIFT (@)WSFT(16)		<p>The data in the words from the starting word (St) through to the ending word (E), is shifted left in word units, writing all zeros into the starting word.</p>
ARITHMETIC SHIFT LEFT (@)ASL(25)		<p>Each bit within a single word of data (Wd) is shifted one bit to the left, with zero written to bit 00 and bit 15 moving to CY.</p>
ARITHMETIC SHIFT RIGHT (@)ASR(26)		<p>Each bit within a single word of data (Wd) is shifted one bit to the right, with zero written to bit 15 and bit 00 moving to CY.</p>

- An instruction marked with "@" can be used as a differentiated instruction that will be executed only once each time the instruction executing condition is turned ON.
- An instruction marked with "*" is an expansion instruction. These instructions must be assigned function codes before they can be used.
- An instruction marked with ":-" is an expansion instruction. The assigned function code is the default for the C200HX/HG/HE PLC.

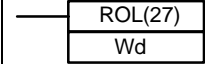
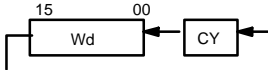
PROGRAMMING INSTRUCTIONS

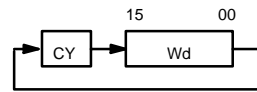
DATA SHIFTING INSTRUCTIONS (CONTINUED)

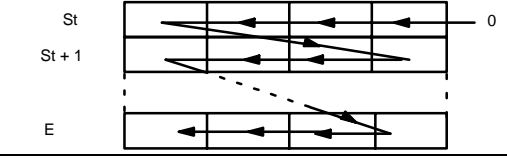
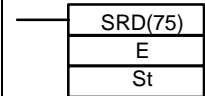
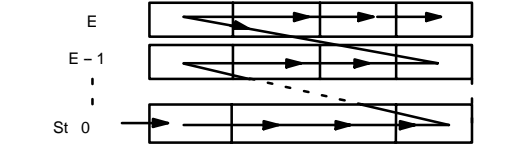
NAME MNEMONIC	SYMBOL	FUNCTION
ROTATE LEFT (@)ROL(27)		<p>Each bit within a single word of data (Wd) is moved one bit to the left, with bit 15 moving to carry (CY), and CY moving to bit 00.</p> 
ROTATE RIGHT (@)ROR(28)		<p>Each bit within a single word of data (Wd) is moved one bit to the right, with bit 00 moving to carry (CY), and CY moving to bit 15.</p> 
ONE DIGIT SHIFT LEFT (@)SLD(74)		<p>Shifts all data, between the starting word (St) and ending word (E), one digit (four bits) to the left, writing zero into the rightmost digit of the starting word.</p> 
ONE DIGIT SHIFT RIGHT (@)SRD(75)		<p>Shifts all data, between starting word (St) and ending word (E), one digit (four bits) to the right, writing zero into the leftmost digit of the ending word.</p> 

- An instruction marked with "@" can be used as a differentiated instruction that will be executed only once each time the instruction executing condition is turned ON.
- An instruction marked with "*" is an expansion instruction. These instructions must be assigned function codes before they can be used.
- An instruction marked with "※" is an expansion instruction. The assigned function code is the default for the C200HX/HG/HE PLC.

PROGRAMMING INSTRUCTIONS

BCD ARITHMETIC INSTRUCTIONS

NAME MNEMONIC	SYMBOL	FUNCTION				
BCD ADD (@)ADD(30)	<table border="1"> <tr><td>ADD(30)</td></tr> <tr><td>Au</td></tr> <tr><td>Ad</td></tr> <tr><td>R</td></tr> </table>	ADD(30)	Au	Ad	R	<p>Adds two 4-digit BCD values (Au and Ad) and content of CY, and outputs the result to the specified result word (R).</p> $Au + Ad + \boxed{CY} \rightarrow R \quad \boxed{CY}$
ADD(30)						
Au						
Ad						
R						
DOUBLE BCD ADD (@)ADDL(54)	<table border="1"> <tr><td>ADDL(54)</td></tr> <tr><td>Au</td></tr> <tr><td>Ad</td></tr> <tr><td>R</td></tr> </table>	ADDL(54)	Au	Ad	R	<p>Adds two 8-digit values (2 words each) and the content of CY, and outputs the result.</p> $\begin{array}{r} \boxed{Au+1} \quad \boxed{Au} \\ + \quad \boxed{Ad+1} \quad \boxed{Ad} \\ + \quad \quad \quad \boxed{CY} \\ \hline \boxed{CY} \quad \boxed{R+1} \quad \boxed{R} \end{array}$
ADDL(54)						
Au						
Ad						
R						
BCD SUBTRACT (@)SUB(31)	<table border="1"> <tr><td>SUB(31)</td></tr> <tr><td>Mi</td></tr> <tr><td>Su</td></tr> <tr><td>R</td></tr> </table>	SUB(31)	Mi	Su	R	<p>Subtracts both the 4-digit BCD subtrahend (Su) and content of CY, from the 4-digit BCD minuend (Mi) and outputs the result to the specified result word (R).</p> $Mi - Su - \boxed{CY} \rightarrow R \quad \boxed{CY}$
SUB(31)						
Mi						
Su						
R						
DOUBLE BCD SUBTRACT (@)SUBL(55)	<table border="1"> <tr><td>SUBL(55)</td></tr> <tr><td>Mi</td></tr> <tr><td>Su</td></tr> <tr><td>R</td></tr> </table>	SUBL(55)	Mi	Su	R	<p>Subtracts both the 8-digit BCD subtrahend and the content of CY from an 8-digit BCD minuend, and outputs the result.</p> $\begin{array}{r} \boxed{Mi+1} \quad \boxed{Mi} \\ - \quad \boxed{Su+1} \quad \boxed{Su} \\ - \quad \quad \quad \boxed{CY} \\ \hline \boxed{CY} \quad \boxed{R+1} \quad \boxed{R} \end{array}$
SUBL(55)						
Mi						
Su						
R						
BCD MULTIPLY (@)MUL(32)	<table border="1"> <tr><td>MUL(32)</td></tr> <tr><td>Md</td></tr> <tr><td>Mr</td></tr> <tr><td>R</td></tr> </table>	MUL(32)	Md	Mr	R	<p>Multiplies the 4-digit BCD multiplicand (Md) and 4-digit BCD multiplier (Mr), and outputs the result to the specified result words (R and R + 1).</p> $Md \times Mr \rightarrow \boxed{R+1} \quad \boxed{R}$
MUL(32)						
Md						
Mr						
R						
DOUBLE BCD MULTIPLY (@)MULL(56)	<table border="1"> <tr><td>MULL(56)</td></tr> <tr><td>Md</td></tr> <tr><td>Mr</td></tr> <tr><td>R</td></tr> </table>	MULL(56)	Md	Mr	R	<p>Multiplies the 8-digit BCD multiplicand and 8-digit BCD multiplier, and outputs the result.</p> $\begin{array}{r} \boxed{Md+1} \quad \boxed{Md} \\ X \quad \boxed{Mr+1} \quad \boxed{Mr} \\ \hline \boxed{R+3} \quad \boxed{R+2} \quad \boxed{R+1} \quad \boxed{R} \end{array}$
MULL(56)						
Md						
Mr						
R						

- An instruction marked with "@" can be used as a differentiated instruction that will be executed only once each time the instruction executing condition is turned ON.
- An instruction marked with "★" is an expansion instruction. These instructions must be assigned function codes before they can be used.
- An instruction marked with "⌘" is an expansion instruction. The assigned function code is the default for the C200HX/HG/HE PLC.

PROGRAMMING INSTRUCTIONS

BCD ARITHMETIC INSTRUCTIONS (CONTINUED)

NAME MNEMONIC	SYMBOL	FUNCTION
BCD DIVIDE (@)DIV(33)		<p>Divides the 4-digit BCD dividend (Dd) by the 4-digit BCD divisor (Dr), and outputs the result to the specified result words. R receives the quotient; R + 1 receives the remainder.</p> <p>Dd ÷ Dr → R + 1 R</p>
DOUBLE BCD DIVIDE (@)DIVL(57)		<p>Divides the 8-digit BCD dividend by an 8-digit BCD divisor, and outputs the result.</p> <p> </p>
SET CARRY (@)STC(40)		Sets the Carry Flag (i.e., turns CY ON).
CLEAR CARRY (@)CLC(41)		Clears the Carry Flag (i.e., turns CY OFF).
INCREMENT (@)INC(38)		Increases the value of a 4-digit BCD word (Wd) by one, without affecting carry (CY).
DECREMENT (@)DEC(39)		Decrements the value of a 4-digit BCD word by 1, without affecting carry (CY).
SQUARE ROOT (@)ROOT(72)		<p>Computes the square root of an 8-digit BCD value (Sq and Sq + 1) and outputs the truncated 4-digit, integer result to the specified result word (R).</p> <p> </p>
FLOATING POINT DIVIDE (@)FDIV(79)		<p>Divides one floating point value by another and outputs a floating point result.</p> <p> </p>

- An instruction marked with "@" can be used as a differentiated instruction that will be executed only once each time the instruction executing condition is turned ON.
- An instruction marked with "★" is an expansion instruction. These instructions must be assigned function codes before they can be used.
- An instruction marked with "∴" is an expansion instruction. The assigned function code is the default for the C200HX/HG/HE PLC.

PROGRAMMING INSTRUCTIONS

ADVANCED I/O INSTRUCTIONS

NAME MNEMONIC	SYMBOL	FUNCTION
TEN KEY INPUT TKY ★		Inputs 8 digits of BCD data from a 10-key keypad.
HEXADECIMAL KEY INPUT HKY ★		This instruction inputs 8 digits in hexadecimal from a hexadecimal keyboard.
DIGITAL SWITCH INPUT DSW ★		Inputs 4- or 8-digit BCD data from a digital switch.
7-SEGMENT DISPLAY OUTPUT 7SEG ★		Converts 4- or 8-digit BCD data to 7-segment display format and then outputs the converted data.
MATRIX INPUT MTR ★		Inputs data from an 8 input point × 8 output point matrix and records that data in D to D+3.

- An instruction marked with "@" can be used as a differentiated instruction that will be executed only once each time the instruction executing condition is turned ON.
- An instruction marked with "★" is an expansion instruction. These instructions must be assigned function codes before they can be used.
- An instruction marked with "※" is an expansion instruction. The assigned function code is the default for the C200HX/HG/HE PLC.

PROGRAMMING INSTRUCTIONS

SUBROUTINE INSTRUCTIONS

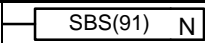
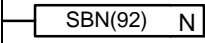
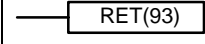
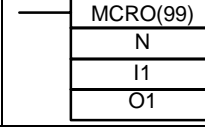
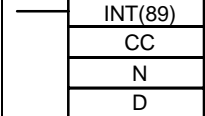
NAME MNEMONIC	SYMBOL	FUNCTION
SUBROUTINE ENTRY (@)SBS(91)		Calls subroutine N. Moves program operation to the specified subroutine.
SUBROUTINE DEFINE SBN(92)		Marks the start of subroutine N.
SUBROUTINE RETURN RET(93)		Marks the end of a subroutine and returns control to the main program.
MACRO (@)MCRO(99)		Calls and executes a subroutine replacing I/O words.
INTERRUPT CONTROL (@)INT(89) *		Controls scheduled interrupts and interrupts from Interrupt Input Units.

- An instruction marked with "@" can be used as a differentiated instruction that will be executed only once each time the instruction executing condition is turned ON.
- An instruction marked with "*" is an expansion instruction. These instructions must be assigned function codes before they can be used.
- An instruction marked with "*" is an expansion instruction. The assigned function code is the default for the C200HX/HG/HE PLC.

PROGRAMMING INSTRUCTIONS

DATA COMPARISON INSTRUCTIONS

NAME MNEMONIC	SYMBOL	FUNCTION				
COMPARE (@)CMP(20)	<table border="1"> <tr><td>CMP(20)</td></tr> <tr><td>Cp1</td></tr> <tr><td>Cp2</td></tr> </table>	CMP(20)	Cp1	Cp2	Compares the data in two 4-digit hexadecimal words (Cp1 and Cp2) and outputs result to the GR, EQ, or LE Flags.	
CMP(20)						
Cp1						
Cp2						
SIGNED BINARY COMPARE (@)CPS ★	<table border="1"> <tr><td>CPS(--)</td></tr> <tr><td>Cp1</td></tr> <tr><td>Cp2</td></tr> </table>	CPS(--)	Cp1	Cp2	Compares two 16-bit (4-digit) signed binary values and outputs the result to the GR, EQ, and LE flags.	
CPS(--)						
Cp1						
Cp2						
DOUBLE COMPARE CMPL(60)	<table border="1"> <tr><td>CMPL(60)</td></tr> <tr><td>S₁</td></tr> <tr><td>S₂</td></tr> </table>	CMPL(60)	S ₁	S ₂	Compares the 8-digit hexadecimal values in words S ₁ +1 and S ₁ with the values in S ₂ +1 and S ₂ , and indicates the result using the Greater Than, Less Than, and Equal Flags.	
CMPL(60)						
S ₁						
S ₂						
DOUBLE SIGNED BINARY COMPARE (@)CPSL ★	<table border="1"> <tr><td>CPSL(--)</td></tr> <tr><td>Cp1</td></tr> <tr><td>Cp2</td></tr> </table>	CPSL(--)	Cp1	Cp2	Compares two 32-bit (8-digit) signed binary values and outputs the result to the GR, EQ, and LE flags.	
CPSL(--)						
Cp1						
Cp2						
BLOCK COMPARE (@)BCMP(68)	<table border="1"> <tr><td>BCMP(68)</td></tr> <tr><td>S</td></tr> <tr><td>CB</td></tr> <tr><td>R</td></tr> </table>	BCMP(68)	S	CB	R	<p>Compares a 1-word binary value (S) with the 16 ranges given in the comparison table (CB is the starting word of the comparison block). If the value falls within any of the ranges, the corresponding bits in the result word (R) will be set.</p> <p style="text-align: center;">Lower limit ≤ S ≤ Upper limit 1</p>
BCMP(68)						
S						
CB						
R						
TABLE COMPARE (@)TCMP(85)	<table border="1"> <tr><td>TCMP(85)</td></tr> <tr><td>CD</td></tr> <tr><td>Tb</td></tr> <tr><td>R</td></tr> </table>	TCMP(85)	CD	Tb	R	<p>Compares a 4-digit hexadecimal value (CD) with values in table consisting of 16 words. If the value of CD falls within any of the comparison ranges, corresponding bits in result word (R) are set.</p> <p>1: same 0: different</p>
TCMP(85)						
CD						
Tb						
R						

- An instruction marked with "@" can be used as a differentiated instruction that will be executed only once each time the instruction executing condition is turned ON.
- An instruction marked with "★" is an expansion instruction. These instructions must be assigned function codes before they can be used.
- An instruction marked with "⌘" is an expansion instruction. The assigned function code is the default for the C200HX/HG/HE PLC.

PROGRAMMING INSTRUCTIONS

DATA COMPARISON INSTRUCTIONS (CONTINUED)

NAME MNEMONIC	SYMBOL	FUNCTION				
MULTI-WORD COMPARE (@)MCMP(19) *	<table border="1"> <tr><td>MCMP(19)</td></tr> <tr><td>S₁</td></tr> <tr><td>S₂</td></tr> <tr><td>D</td></tr> </table>	MCMP(19)	S ₁	S ₂	D	Compares the data within a block of 16 words of 4-digit hexadecimal data (S ₁ to S ₁ +15) with that in another block of 16 words (S ₂ to S ₂ +15) on a word-by-word basis. If the words are not the same, the bit corresponding to different words turns ON in the result word, D.
MCMP(19)						
S ₁						
S ₂						
D						
AREA RANGE COMPARE ZCP(88) *	<table border="1"> <tr><td>ZCP(--)</td></tr> <tr><td>CD</td></tr> <tr><td>LL</td></tr> <tr><td>UL</td></tr> </table>	ZCP(--)	CD	LL	UL	Compares a word to a range defined by lower and upper limits and outputs the result to the GR, EQ, and LE flags.
ZCP(--)						
CD						
LL						
UL						
DOUBLE AREA RANGE COMPARE ZCPL ★	<table border="1"> <tr><td>ZCPL(--)</td></tr> <tr><td>CD</td></tr> <tr><td>LL</td></tr> <tr><td>UL</td></tr> </table>	ZCPL(--)	CD	LL	UL	Compares an 8-digit value to a range defined by lower and upper limits and outputs the result to the GR, EQ, and LE flags.
ZCPL(--)						
CD						
LL						
UL						

- An instruction marked with "@" can be used as a differentiated instruction that will be executed only once each time the instruction executing condition is turned ON.
- An instruction marked with "★" is an expansion instruction. These instructions must be assigned function codes before they can be used.
- An instruction marked with "⋆" is an expansion instruction. The assigned function code is the default for the C200HX/HG/HE PLC.

PROGRAMMING INSTRUCTIONS

DATA TRANSFER INSTRUCTIONS

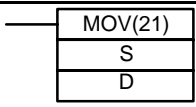
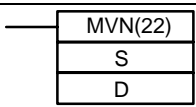
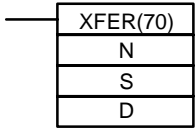
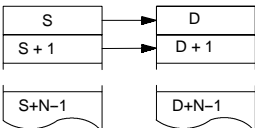
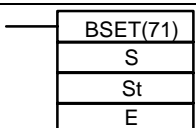
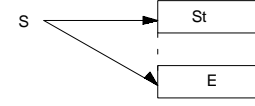
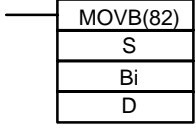
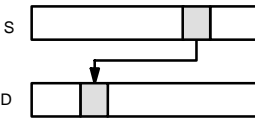
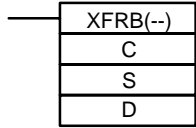
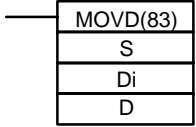
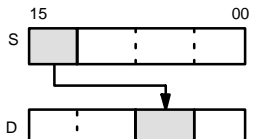
NAME MNEMONIC	SYMBOL	FUNCTION
MOVE (@)MOV(21)		Transfers data from source word, (S) to destination word (D).
MOVE NOT (@)MVN(22)		Transfers the inverse of the data in the source word (S) to destination word (D).
BLOCK TRANSFER (@)XFER(70)		Moves the content of consecutive source words (S gives the address of the starting source word) to consecutive destination words (D is the starting destination word). 
BLOCK SET (@)BSET(71)		Copies the content of one word or constant (S) to several consecutive words (from the starting word, St, through to the ending word, E). 
MOVE BIT (@)MOVB(82)		Transfers the designated bit of the source word or constant (S) to the designated bit of the destination word (D). 
TRANSFER BITS @XFRB(62) *		Copies the status of up to 255 specified source bits to the specified destination bits.
MOVE DIGIT (@)MOVD(83)		Moves hexadecimal content of up to four specified 4-bit source digit(s) from the source word to the specified destination digit(s). 

- An instruction marked with "@" can be used as a differentiated instruction that will be executed only once each time the instruction executing condition is turned ON.
- An instruction marked with "*" is an expansion instruction. These instructions must be assigned function codes before they can be used.
- An instruction marked with ":-" is an expansion instruction. The assigned function code is the default for the C200HX/HG/HE PLC.

PROGRAMMING INSTRUCTIONS

DATA TRANSFER INSTRUCTIONS (CONTINUED)

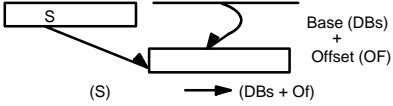
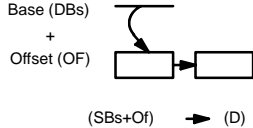
NAME MNEMONIC	SYMBOL	FUNCTION				
NETWORK SEND (@)SEND(90)	<table border="1"> <tr><td>SEND(90)</td></tr> <tr><td>S</td></tr> <tr><td>D</td></tr> <tr><td>C</td></tr> </table>	SEND(90)	S	D	C	Transfers data from n source words (S is the starting word) to the destination words (D is the first address) in node N of the specified network (in a SYSMAC LINK or NET Link System).
SEND(90)						
S						
D						
C						
NETWORK RECEIVE (@)RCV(98)	<table border="1"> <tr><td>RCV(98)</td></tr> <tr><td>S</td></tr> <tr><td>D</td></tr> <tr><td>C</td></tr> </table>	RCV(98)	S	D	C	Transfers data from the source words (S is the first word) from node N of the specified network (in a SYSMAC LINK or NET Link System) to the destination words starting at D.
RCV(98)						
S						
D						
C						
SINGLE WORD DISTRIBUTE (@)DIST(80)	<table border="1"> <tr><td>DIST(80)</td></tr> <tr><td>S</td></tr> <tr><td>DBs</td></tr> <tr><td>Of</td></tr> </table>	DIST(80)	S	DBs	Of	Moves one word of source data (S) to the destination given by the destination base word (DBs) plus offset (Of). 
DIST(80)						
S						
DBs						
Of						
DATA COLLECT (@)COLL(81)	<table border="1"> <tr><td>COLL(81)</td></tr> <tr><td>SBs</td></tr> <tr><td>Of</td></tr> <tr><td>D</td></tr> </table>	COLL(81)	SBs	Of	D	Extracts data from the source word and writes it to the destination word (D). 
COLL(81)						
SBs						
Of						
D						
EXPANSION DM READ (@)XDMR ★	<table border="1"> <tr><td>XDMR(--)</td></tr> <tr><td>N</td></tr> <tr><td>S</td></tr> <tr><td>D</td></tr> </table>	XDMR(--)	N	S	D	The contents of the designated number of words of the fixed expansion DM data are read and output to the destination word on the PLC side.
XDMR(--)						
N						
S						
D						
RECEIVE (@)RXD ★	<table border="1"> <tr><td>RXD(--)</td></tr> <tr><td>D</td></tr> <tr><td>C</td></tr> <tr><td>N</td></tr> </table>	RXD(--)	D	C	N	Receives data via a communications port.
RXD(--)						
D						
C						
N						

- An instruction marked with "@" can be used as a differentiated instruction that will be executed only once each time the instruction executing condition is turned ON.
- An instruction marked with "★" is an expansion instruction. These instructions must be assigned function codes before they can be used.
- An instruction marked with ":-" is an expansion instruction. The assigned function code is the default for the C200HX/HG/HE PLC.

PROGRAMMING INSTRUCTIONS

DATA TRANSFER INSTRUCTIONS (CONTINUED)

NAME MNEMONIC	SYMBOL	FUNCTION
TRANSMIT (@)TXD ★		Sends data via a communications port.
EM CONSTANT BLOCK TRANSFER (@)XFR2 ★		Sends data of more than one word existing in series from the designated word to the words following the designated word. When a constant is designated where the data is sent to or sent from, the EM area is designated.
EM CONSTANT INTERBANK BLOCK TRANSFER (@)BXF2 ★		Sends data of more than one word existing in series from the designated word to the words following the designated word. If the designated word is in an EM area, the bank number can be specified.
SETUP CHANGE (@)STUP ★		Sends the designated word content (for 5 words) to the system setting area of designated RS-232 port.
EXPANSION DM BANK CHANGE (@)EMBC ★		Changes the current bank of the Expansion DM.
INDIRECT EXPANSION DM SETTING (@)IEMS ★		Switches the indirect execution area between DM and EM. Current bank can be switched when changing to EM.

- An instruction marked with "@" can be used as a differentiated instruction that will be executed only once each time the instruction executing condition is turned ON.
- An instruction marked with "★" is an expansion instruction. These instructions must be assigned function codes before they can be used.
- An instruction marked with "⌘" is an expansion instruction. The assigned function code is the default for the C200HX/HG/HE PLC.

PROGRAMMING INSTRUCTIONS

LOGIC INSTRUCTIONS

NAME MNEMONIC	SYMBOL	FUNCTION
LOGICAL AND (@)ANDW(34)		Logically ANDs two 16-bit input words (I1 and I2) and sets the bits in the result word (R) if the corresponding bits in the input words are both ON.
LOGICAL OR (@)ORW(35)		Logically ORs two 16-bit input words (I1 and I2) and sets the bits in the result word (R) when one or both of the corresponding bits in the input words is/are ON.
EXCLUSIVE OR (@)XORW(36)		Exclusively ORs two 16-bit input words (I1 and I2) and sets the bits in the result word (R) when the corresponding bits in input words differ in status.
EXCLUSIVE NOR (@)XNRW(37)		Exclusively NORs two 16-bit input words (I1 and I2) and sets the bits in the result word (R) when the corresponding bits in both input words have the same status.
COMPLEMENT (@)COM(29)		Inverts bit status of one word (Wd) of data, changing 0s to 1s, and vice versa.

- An instruction marked with "@" can be used as a differentiated instruction that will be executed only once each time the instruction executing condition is turned ON.
- An instruction marked with "★" is an expansion instruction. These instructions must be assigned function codes before they can be used.
- An instruction marked with ":-" is an expansion instruction. The assigned function code is the default for the C200HX/HG/HE PLC.

PROGRAMMING INSTRUCTIONS

SYSTEM PROCESSING INSTRUCTIONS

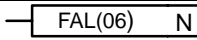
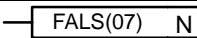
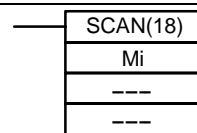
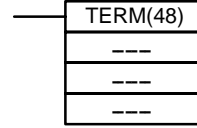
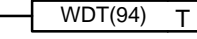
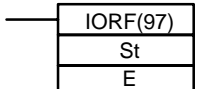
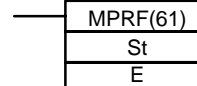
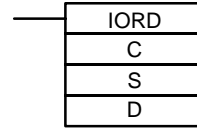
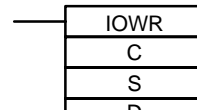
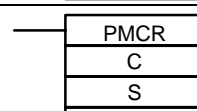
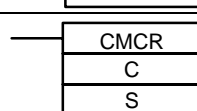
NAME MNEMONIC	SYMBOL	FUNCTION
FAILURE ALARM (@)FAL(06)		Assigns a failure alarm code to the given execution condition. This code is generated as an error code whenever the instruction is executed.
SEVERE FAILURE ALARM FALS(07)		A fatal version of FAL(06). When a FALS(07) instruction is executed the CPU is stopped and the number is generated as an error code.
CYCLE TIME (@)SCAN(18) *		Sets the minimum cycle time, Mi, in tenths of milliseconds. The possible setting range is from 0 to 999.0 ms.
TERMINAL MODE (@)TERM(48) *		Shifts the Programming Console to TERMINAL mode.
WATCHDOG TIMER REFRESH (@)WDT(94)		Sets the maximum and minimum limits for the watchdog timer (normally 0 to 130 ms). New limits: Maximum time = 130 + (100 x T) Minimum time = 130 + (100 x (T-1))
I/O REFRESH (@)IORF(97)		Can refresh I/O words allocated to CPU or Expansion I/O Racks and Special I/O Modules.
GROUP-2 HIGH-DENSITY I/O REFRESH (@)MPRF(61) *		Refreshes I/O words allocated to Group-2 High-density I/O Modules.
INTELLIGENT IO READ (@)IORD ★		Reads data of more than one word from an ASCII Module, etc.
INTELLIGENT IO WRITE (@)IOWR ★		Writes data of more than one word from a PLC's CPU to an ASCII Module.
PROTOCOL MACRO (@)PMCR ★		By calling the send/receive sequence (protocol data) registered in the Communication Board connected to a PLC's CPU, data can be sent to or received from another personal computer that has RS-232C.
CARD MACRO (@)CMCR ★		Reads or writes files in the memory card of the PC Card Module.

- An instruction marked with "@" can be used as a differentiated instruction that will be executed only once each time the instruction executing condition is turned ON.
- An instruction marked with "★" is an expansion instruction. These instructions must be assigned function codes before they can be used.
- An instruction marked with "※" is an expansion instruction. The assigned function code is the default for the C200HX/HG/HE PLC.

PROGRAMMING INSTRUCTIONS

STEP LADDER INSTRUCTIONS

NAME MNEMONIC	SYMBOL	FUNCTION
STEP DEFINE STEP(08)	STEP(08) B	When used with a control bit (B), defines the start of a new step and resets the previous step. When used without B, it defines the end of step execution.
STEP START SNXT(09)	SNXT(09) B	Used with a control bit (B) to indicate the end of the step, reset the step, and start the next step which has been defined with the same control bit.

- An instruction marked with "@" can be used as a differentiated instruction that will be executed only once each time the instruction executing condition is turned ON.
- An instruction marked with "★" is an expansion instruction. These instructions must be assigned function codes before they can be used.
- An instruction marked with "⌘" is an expansion instruction. The assigned function code is the default for the C200HX/HG/HE PLC.

PROGRAMMING INSTRUCTIONS

BINARY ARITHMETIC INSTRUCTIONS

NAME MNEMONIC	SYMBOL	FUNCTION				
BINARY ADD (@)ADB(50)	<table border="1"> <tr><td>ADB(50)</td></tr> <tr><td>Au</td></tr> <tr><td>Ad</td></tr> <tr><td>R</td></tr> </table>	ADB(50)	Au	Ad	R	<p>Adds the 4-digit augend (Au), 4-digit addend (Ad), and content of CY and outputs the result to the specified result word (R).</p> $ \begin{array}{r} \text{Au} \\ + \text{Ad} \\ + \text{CY} \\ \hline \text{R} \\ \text{CY} \end{array} $
ADB(50)						
Au						
Ad						
R						
DOUBLE BINARY ADD (@)ADBL ★	<table border="1"> <tr><td>ADBL(--)</td></tr> <tr><td>Au</td></tr> <tr><td>Ad</td></tr> <tr><td>R</td></tr> </table>	ADBL(--)	Au	Ad	R	<p>Adds two 8-digit binary values (normal or signed data) and contents of carry, and outputs the result to R and R+1.</p> $ \begin{array}{r} \text{Au} + 1 \quad \text{Au} \\ \text{Ad} + 1 \quad \text{Ad} \\ + \quad \text{CY} \\ \hline \text{CY} \quad \text{R} + 1 \quad \text{R} \end{array} $
ADBL(--)						
Au						
Ad						
R						
BINARY SUBTRACT (@)SBB(51)	<table border="1"> <tr><td>SBB(51)</td></tr> <tr><td>Mi</td></tr> <tr><td>Su</td></tr> <tr><td>R</td></tr> </table>	SBB(51)	Mi	Su	R	<p>Subtracts the 4-digit hexadecimal subtrahend (Su) and content of carry, from the 4-digit hexadecimal minuend (Mi), and outputs the result to the specified result word (R).</p> $ \begin{array}{r} \text{Mi} \\ - \text{Su} \\ - \text{CY} \\ \hline \text{R} \\ \text{CY} \end{array} $
SBB(51)						
Mi						
Su						
R						
DOUBLE BINARY SUBTRACT (@)SBBL ★	<table border="1"> <tr><td>SBBL(--)</td></tr> <tr><td>Mi</td></tr> <tr><td>Su</td></tr> <tr><td>R</td></tr> </table>	SBBL(--)	Mi	Su	R	<p>Subtracts an 8-digit binary value (normal or signed data) and contents of carry from another and outputs the result to R and R+1.</p> $ \begin{array}{r} \text{Mi} + 1 \quad \text{Mi} \\ \text{Su} + 1 \quad \text{Su} \\ - \quad \text{CY} \\ \hline \text{CY} \quad \text{R} + 1 \quad \text{R} \end{array} $
SBBL(--)						
Mi						
Su						
R						
BINARY MULTIPLY (@)MLB(52)	<table border="1"> <tr><td>MLB(52)</td></tr> <tr><td>Md</td></tr> <tr><td>Mr</td></tr> <tr><td>R</td></tr> </table>	MLB(52)	Md	Mr	R	<p>Multiplies the 4-digit hexadecimal multiplicand (Md) and 4-digit multiplier (Mr), and outputs the 8-digit hexadecimal result to the specified result words (R and R+1).</p> $ \begin{array}{r} \text{Md} \\ \times \text{Mr} \\ \hline \text{R} + 1 \quad \text{R} \end{array} $
MLB(52)						
Md						
Mr						
R						

- An instruction marked with "@" can be used as a differentiated instruction that will be executed only once each time the instruction executing condition is turned ON.
- An instruction marked with "★" is an expansion instruction. These instructions must be assigned function codes before they can be used.
- An instruction marked with "⌘" is an expansion instruction. The assigned function code is the default for the C200HX/HG/HE PLC.

PROGRAMMING INSTRUCTIONS

BINARY ARITHMETIC INSTRUCTIONS (CONTINUED)

NAME MNEMONIC	SYMBOL	FUNCTION
SIGNED BINARY MULTIPLY (@)MBS ★	MBS(--) Md Mr R	Multiplies the signed binary content of two words and outputs the 8-digit signed binary result to R+1 and R.
DOUBLE SIGNED BINARY MULTIPLY (@)MBSL ★	MBSL(--) Md Mr R	Multiplies two 32-bit (8-digit) signed binary values and outputs the 16-digit signed binary result to R+3 through R.
BINARY DIVIDE (@)DVB(53)	DVB(53) Dd Dr R	Divides the 4-digit hexadecimal dividend (Dd) by the 4-digit divisor (Dr), and outputs result to the designated result words (R and R + 1).
SIGNED BINARY DIVIDE (@)DBS ★	DBS(--) Dd Dr R	Divides one 16-bit signed binary value by another and outputs the 32-bit signed binary result to R+1 and R.
DOUBLE SIGNED BINARY DIVIDE (@)DBSL ★	DBSL(--) Dd Dr R	Divides one 32-bit signed binary value by another and outputs the 64-bit signed binary result to R+3 to R.

- An instruction marked with "@" can be used as a differentiated instruction that will be executed only once each time the instruction executing condition is turned ON.
- An instruction marked with "★" is an expansion instruction. These instructions must be assigned function codes before they can be used.
- An instruction marked with "⌘" is an expansion instruction. The assigned function code is the default for the C200HX/HG/HE PLC.







STANDARD PARTS



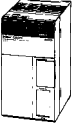

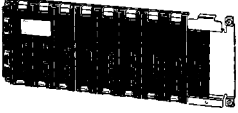
CPU RACK

CPU Rack

ITEM	DESCRIPTION				PART NUMBER	STANDARDS	
CPUs (All models are provided with clock function and slots for communications except CPU11-E.) 	UM	DM	I/O points	RS-232C		U, C, N, CE	
	3.2K words	4K words	640	No	C200HE-CPU11-E		
	7.2K words	6K words	880	No	C200HE-CPU32-E		
		8K words		Yes	C200HE-CPU42-E		
	15.2K words	12K words	1,184	No	C200HG-CPU33-E		
				Yes	C200HG-CPU43-E		
		31.2K words		24K words	No		C200HX-CPU34-E
					Yes		C200HX-CPU44-E
			No	C200HX-CPU54-E			
			Yes	C200HX-CPU64-E			
Power Supply Modules 	100 to 120/200 to 240 VAC				C200HW-PA204		
	100 to 120/200 to 240 VAC (with 24-VDC output terminals)				C200HW-PA204S		
	24 VDC				C200HW-PD024		
CPU I/O Backplanes 	3 slots			C200HW-BC031			
	5 slots			C200HW-BC051			
	8 slots			C200HW-BC081			
	10 slots			C200HW-BC101			
Communication Boards 	Communications port for SYSMAC LINK and SYSMAC NET Link Modules				C200HW-COM01		
	RS-232C port				C200HW-COM02		
	RS-422/485 port				C200HW-COM03		
	Communications port for the SYSMAC LINK Module and SYSMAC NET Link Module and a protocol macro function				C200HW-COM04-E		
	Two RS-232C ports and a protocol macro function				C200HW-COM05-E		
	RS-422/485 port, an RS-232C port, and a protocol macro function				C200HW-COM06-E		
Memory Cassettes 	EEPROM	4K words	C200HW-ME04K		N, CE		
		8K words	C200HW-ME08K				
		16K words	C200HW-ME16K		N		
		32K words	C200HW-ME32K		N, CE		
	EPROM	16K words/32K words		C200HS-MP16K		L, CE	
		Equivalent to 27256, 150 ns, 12.5 V		ROM-JD-B		CE	
		Equivalent to 27512, 150 ns, 12.5 V		ROM-KD-B			

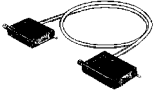

Expansion Rack

ITEM	DESCRIPTION		PART NUMBER	STANDARDS
Power Supply Modules 	100 to 120/200 to 240 VAC		C200HW-PA204	U, C, N, CE
	100 to 120/200 to 240 VAC (with 24-VDC output terminals)		C200HW-PA204S	
	24 VDC		C200HW-PD024	
Expansion I/O Backplanes 	3 slots		C200HW-BI031	
	5 slots		C200HW-BI051	
	8 slots		C200HW-BI081	
	10 slots		C200HW-BI0101	
I/O Connecting Cables 	30 cm	The total length of the I/O Connecting Cables used in a network must be 12 m maximum.	C200H-CN311	---
	70 cm		C200H-CN711	
	200 cm		C200H-CN221	
	500 cm		C200H-CN521	
	1,000 cm		C200H-CN131	

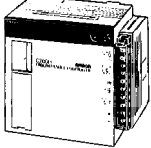
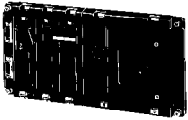
Slave Rack

Slave Racks Remote I/O Slave Modules 	100 to 120/200 to 240 VAC (switchable)		APF/PCF	C200H-RT001-P	U, C, N, L
	24 VDC			C200H-RT002-P	
	100 to 120/200 to 240 VAC (switchable)		Wired	C200H-RT201	U, C, N, L
	24 VDC			C200H-RT201-C	CE
Backplanes 	3 slots		C200H-BC031-V2		U, C, N, L, CE
	5 slots		C200H-BC081-V2		
	8 slots		C200H-BC051-V2		
	10 slots		C200H-BC101-V2		
I/O Blocks	Input	Specify either 12 or 24 VDC.	G71-IC16		U, C, N, L
	Output		G71-OD16		
I/O Terminals	AC input	Specify either 100 or 200 VAC.		G7TC-IA16	
	DC input	Specify either 12 or 24 VDC.		G7TC-ID16	
	Output	Specify either 12 or 24 VDC.		G7TC-OC16	
Link Adapter	O/E converter; 1 connector for RS-485, 1 connector each for APF/PCF		B500-AL007-P		



I/O MODULES

ITEM		DESCRIPTION		PART NUMBER	STANDARDS	
	AC Input Modules	8 pts	100 to 120 VAC	C200H-IA121	U, C, N, L	
		16 pts	100 to 120 VAC	C200H-IA122	U, C, N, L	
		8 pts	200 to 240 VAC	C200H-IA221	U, C, N, L	
		16 pts	200 to 240 VAC	C200H-IA222		
	DC Input Modules	8 pts	12 to 24 VDC	C200H-ID211	U, C, N, L, CE	
		16 pts	24 VDC	C200H-ID212		
	AC/DC Input Modules	8 pts	12 to 24 VAC/DC	C200H-IM211		
		16 pts	24 VAC/DC	C200H-IM212		
	Interrupt Input Module (see note)	8 pts	12 to 24 VDC	C200HS-INT01	U, C	
		Relay Output Modules	8 pts	2 A, 250 VAC/24 VDC (for resistive load)	C200H-OC221	U, C, N, L
			12 pts	2 A, 250 VAC/24 VDC (for resistive load)	C200H-OC222	
			5 pts	2 A, 250 VAC/24 VDC (for resistive load) Independent commons	C200H-OC223	
8 pts			2 A, 250 VAC/24 VDC (for resistive load) Independent commons	C200H-OC224		
16 pts			2 A, 250 VAC/24 VDC (for resistive load) (see note)	C200H-OC225		
Triac Output Modules		8 pts	1 A, 120 VAC	C200H-OA121-E	U, C	
		8 pts	1 A, 200 VAC	C200H-OA223	N, L, CE	
		12 pts	0.3 A, 200 VAC	C200H-OA222V	CE	
Transistor Output Modules		8 pts	1 A, 12 to 48 VDC	C200H-OD411	U, C, N, L, CE	
		12 pts	0.3 A, 24 VDC	C200H-OD211		
		16 pts	0.3 A, 24 VDC (see note)	C200H-OD212		
		8 pts	2.1 A, 24 VDC	C200H-OD213		
		8 pts	0.8 A, 24 VDC; source type (PNP); w/load short protection	C200H-OD214		U, C, N, L
		8 pts	0.3 A, 5 to 24 VDC; source type (PNP)	C200H-OD216		
		12 pts	0.3 A, 5 to 24 VDC; source type (PNP)	C200H-OD217		
16 pts		1 A, 24 VDC; source type (PNP); w/load short protection	C200H-OD21A	CE		
Analog Timer Module		4 timers	0.1 to 1 s/1 to 10 s/10 to 60 s/1 min to 10 min (switchable)	C200H-TM001	U, C	
	Variable Resistor Connector	Connector w/lead wire (2 m) for 1 external resistor		C4K-CN223	---	
B7A Interface Modules	15 or 16 input pts	Connects to B7A Link Terminals. Standard transmission delay.		C200H-B7A11	U, C, CE	
	16 output pts	Connects to B7A Link Terminals. Standard transmission delay.		C200H-B7AO1 (see note)		



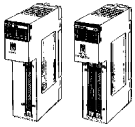

Note: If the Interrupt Input Module is mounted on an Expansion I/O Rack, the interrupt function cannot be used and the Interrupt Input Module will be treated as an ordinary 8-point Input Module. Moreover, Interrupt Input Modules cannot be used on Slave Racks.

SPECIAL I/O MODULES (INCLUDING GROUP 2 I/O)



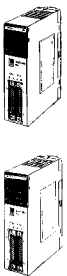

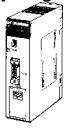

Group-2 I/O Modules

ITEM	DESCRIPTION		PART NUMBER	STANDARDS	
	DC Input Modules	32 pts	24 VDC	C200H-ID216	U, C, N, L, CE
		64 pts		C200H-ID217	
	Transistor Output Modules	32 pts	16 mA at 4.5 V to 100 mA at 26.4 V	C200H-OD218	U, C, N, L
		64 pts		C200H-OD219	
 (GROUP 2 I/O MODULES)	32 input pts	Connects to B7A Link Terminals. Standard or high-speed transmission delay.	C200H-B7A12	---	
	32 output pts		C200H-B7A02		
	16 input and 16 output points		C200H-B7A21		
	32 input and 32 output points		C200H-B7A22		

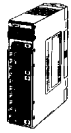
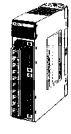

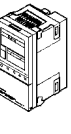
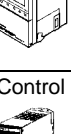
Special I/O Modules

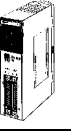
ITEM	DESCRIPTION		PART NUMBER	STANDARDS	
 (see note 1)	DC Input Modules	32 pts	5 VDC (TTL inputs); w/high-speed input	C200H-ID501	U, C, N, L, CE
		32 pts	24 VDC; w/high-speed input	C200H-ID215	
	Transistor Output Modules	32 pts	0.1 A, 24 VDC (useable as 128-point dynamic output unit)	C200H-OD215	
		32 pts	35 mA, 5 VDC (TTL outputs) (useable as 128-point dynamic output unit)	C200H-OD501	
	DC Input/Transistor Output Modules	16 input and 16 output pts	24-VDC inputs; w/high-speed input; 0.1-A, 24-VDC outputs (useable as 128-point dynamic input unit)	C200H-MD215	
		16 input and 16 output pts	5-VDC TTL inputs; w/high speed input; 35-mA, 5-VDC TTL outputs (useable as 128-point dynamic input unit)	C200H-MD501	
16 input and 16 output pts		12-VDC TTL inputs; w/high speed input; 12-VDC TTL outputs (useable as 128-point dynamic input unit)	C200H-MD115	N, L	
	Analog Input Modules	4 to 20 mA, 1 to 5/0 to 10 V (switchable); 4 inputs; 12 bits	C200H-AD001	U, C, N, L	
		4 to 20 mA, 1 to 5/0 to 10 V/-10 to 10V (switchable); 8 inputs; 12 bits or BCD	C200H-AD002		
	Analog Output Modules	4 to 20 mA, 1 to 5/0 to 10 V (switchable); 2 outputs	C200H-DA001	---	
		4 to 20 mA, -10 to 10 V; 4 outputs	C200H-DA002		
	Fuzzy Logic Module	Programmed using the Fuzzy Support Software.	C200H-FZ001	N	
	Fuzzy Support Software	Available on either 3.5" or 5.25" floppy disks.	C500-SU981-E	---	
	Thermocouple	K(CA) or J(IC), switchable; 4 inputs	C200H-TS001	U, C	
		K(CA) or L(Fe-CuNi) DIN standards; 4 inputs	C200H-TS002		
	Pt resistance thermometer	Pt 100 Ω ; 4 inputs	C200H-TS101		
		Pt 100 Ω ; 4 inputs; DIN and 1989 JIS standards	C200H-TS102		

SPECIAL I/O (CONTINUED)

ITEM	DESCRIPTION		PART NUMBER	STANDARDS
Temperature Control Modules 	Thermocouple	Transistor output	C200H-TC001	U, C
		Voltage output	C200H-TC002	
		Current output	C200H-TC003	
	Pt resistance thermometer	Transistor output	C200H-TC101	
		Voltage output	C200H-TC102	
		Current output	C200H-TC103	
Heat/Cool Temperature Control Modules 	Thermocouple	Transistor output	C200H-TV001	
		Voltage output	C200H-TV002	
		Current output	C200H-TV003	
	Pt resistance thermometer	Transistor output	C200H-TV101	
		Voltage output	C200H-TV102	
		Current output	C200H-TV103	
Cam Positioner Module 	Detects angles of rotation by means of a resolver and provides ON and OFF outputs at specified angles. A maximum of 48 cam outputs (16 external outputs and 32 internal outputs) maximum are available.		C200H-CP114	
Data Setting Console 	Used to set and monitor data in Temperature Control Modules and Cam Positioner Modules.		C200H-DSC01	
Connecting Cables 	2 m		C200H-CN225	---
	4 m		C200H-CN425	
PID Control Modules 	Transistor output; 4 to 20 mA/1 to 5 V/0 to 5V/0 to 10 V inputs (selectable)		C200H-PID01	U, C
	Voltage output; 4 to 20 mA/1 to 5 V/0 to 5V/0 to 10 V inputs (selectable)		C200H-PID02	
	Current output; 4 to 20 mA/1 to 5 V/0 to 5V/0 to 10 V inputs (selectable)		C200H-PID03	
Position Control Modules 	1 axis	Pulse output; directly connects to servomotor driver; compatible with line driver; speeds: 1 to 250,000 pps	C200H-NC112	U, C, CE
	2 axis	Pulse output; speeds: 1 to 250,000 pps, 53 pts per axis	C200H-NC211	U, C
High-speed Counter Modules 	1 axis	Pulse input; counting speed: 50 kcps; 5 VDC/12 VDC/24 VDC	C200H-CT001-V1	U, C, CE
	1 axis	Pulse input; counting speed: 75 kcps; RS-422 line driver	C200H-CT002	
	2 axis	Pulse input; counting speed: 75 kcps; RS-422 line driver	C200H-CT021	
ASCII/BASIC Modules 	24K-byte RAM and 24K-byte EEPROM are built-in.		C200H-ASC02	CE

SPECIAL I/O (CONTINUED)



ITEM	DESCRIPTION	PART NUMBER	STANDARDS	
	Local application, electromagnetic coupling	C200H-IDS01-V1	U, C	
	Remote application; microwave transmissions	C200H-IDS21	---	
	Read/Write Heads	Electromagnetic type	V600-H series	
		Microwave type	V620-H series	
	Data Carriers	SRAM type for V600-H series.	V600-D□□R□□	
EEPROM type for V600-H series.		V600-D□□P□□		
	60 messages max.; message length: 32, 48, or 64 s (switchable)	C200H-OV001		
	Connecting Cable	RS-232C	C200H-CN224	
	G-language programmable 2-axis analog outputs	C200H-MC221	---	
	MC Support Software	IBM PC/AT or compatible	CV500-ZN3AT1-E	
	Connecting cable	3.3 m	CQM1-CIF02	
	Teaching Box	---	CVM1-PRS71	
	Connection cable for Teaching Box	2 m long	CV500-CN224	
	Memory Pack (with key sheet) (see note 2)	---	CVM1-MP701	
	Terminal Block Conversion Unit	Simplifies wiring for I/O connectors.	XW2B-20J6-6	
	Connecting cable for Terminal Block Conversion Unit		XW2Z-100J-F1	

- Note:**
1. When mounting a High-density I/O Module as a Special I/O Module to a Slave Rack, the Remote I/O Master must be the C200H-RM001-PV1 or C200H-RM201.
 2. The CV-series Programming Console can be used as a Teaching Box by replacing the Memory Pack of the Programming Console.

I/O MODULE ACCESSORIES

ITEM	DESCRIPTION	PART NUMBER
I/O Terminal BLock Cover	For 10 pin I/O Terminal Blocks	C200H-COV02
	For 19 pin I/O Terminal Blocks	C200H-COV03
	For 5- and 8- point Modules	C200H-COV11
Connector	24-pin, solder type, straight	C500-CE241
	24-pin, crimp type	C500-CE242
	24-pin, for ribbon cable	C500-CE243
	24-pin, solder type, 90° angle	C500-CE244
	40-pin, solder type, straight	C500-CE401
	40-pin, crimp type	C500-CE402
	40-pin, for ribbon cable	C500-CE403
	40-pin, solder type, 90° angle	C500-CE404
	RS-232C, 25 pins	0020756-4, RS-232 connector
	RS-422, 9 pins	0020757-2, RS-422 connector
Connector Cover	RS-232C, 25 pins	0020758-0, RS-232 cover
	RS-422, 9 pins	0020759-9, RS-422 cover

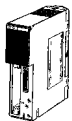
COMMUNICATION MODULES

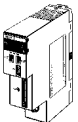
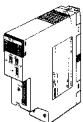
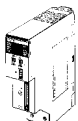
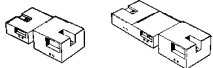
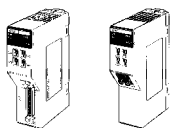
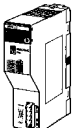
ITEM	DESCRIPTION		PART NUMBER	STANDARDS	
	A memory card suitable for Phoenix PCM+3.2 and one of the following Bus Connection Units is required. No PC card is provided with the module.		C200HW-PCU01-E	---	
	Ethernet Set	A floppy disk containing Ethernet setup utility data is provided. One of the following Bus Connection Units is required. No PC card is provided with the Module.	C200HW-PCS01-E		
		For 1 Module	C200HW-CE011		
For 2 Modules		C200HW-CE012			
	A Bus Connection Unit must be ordered separately.	Data link table: 918 words	C200HW-SLK23	U, C, N	
		Data link table: 2,966 words	C200HW-SLK24		
	Terminator	One required for each node at ends of System.	C1000H-TER01	---	
	Attachment Stirrup	Provided with SYSMAC LINK Module.	C200H-TL001		
	F Adapter	To connect network	C1000H-CE001		
	F Adapter Cover	To connect network	C1000H-COV01		
	Connect with H-PCF cable. A Bus Connection Unit must be ordered separately.	Data link table: 918 words	C200HW-SLK13	U, C, N	
		Data link table: 2,966 words	C200HW-SLK14		
	Power Supply Adapter	Required when supplying backup power	For 1 or 2 Modules	C200H-APS03	U, C
	Power Cable	Connects Power Supply Adapter and SYSMAC NET Link Module.	For 1 Module	C200H-CN111	---
For 2 Modules			C200H-CN211		
SYSMAC LINK Support Board (coaxial cable)	To connect IBM PC/AT or compatible as node in SYSMAC LINK system		3G8F5-SLK21-E		
	A Bus Connection Unit must be ordered separately.		C200HS-SNT32		
	Power Supply Adapter	Required when supplying backup power	For 1 Module	C200H-APS01	
			For 2 Modules	C200H-APS02	
	Power Cable	Connects Power Supply Adapter and SYSMAC NET Link Module.	Included with C200H-APS01	For 1 Module	C200H-CN001
Included with C200H-APS02			For 2 Modules	C200H-CN002	
	Connects SYSMAC LINK Module or SYSMAC NET Link Module to CPU.		For 1 Module	C200HW-CE001	N
			For 2 Modules	C200HW-CE002	
	Rack-mounting	C200H, C200HS, C200HE, C200HG, C200HX	APF/PCF	C200H-LK101-PV1	N, L
			RS-422	C200H-LK202-V1	U, C
			RS-232C	C200H-LK201-V1	
	Number of I/O points: 1,600 max. Number of Slave Modules: 50 max.		C200HW-DRM21	U, C, N	

COMMUNICATION MODULES AND SYSMAC NET/SYSMAC LINK

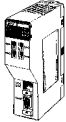
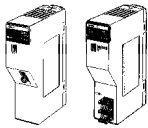
ITEM	DESCRIPTION		PART NUMBER	STANDARDS
PC Link Module 	Single level: 32 Modules Multilevel: 16 Modules	RS-485	C200H-LK401	N, L
Remote I/O Master Modules 	Up to two per PLC; connectable to up to 5 Slaves per PLC total	APF/PCF	C200H-RM001-PV1	
		Wired	C200H-RM201	
Remote I/O Slave Modules	For reference, see <i>Slave Racks</i> on page 125 (also page 84).			

Note: Only a single PC Card Module can be used with the CPU.

SYSMAC NET/SYSMAC LINK Hardware

ITEM	DESCRIPTION	PART NUMBER	STANDARDS
SYSMAC NET Network Support Board	For IBM PC/AT or compatible	S3200-NSB11-E	---
SYSMAC LINK Network Support Board	For IBM PC/AT or compatible, coaxial cable connector	3G8F5-SLK21-E	

FIBER-OPTIC COMMUNICATION MODULE CONNECTIONS

3GS3200 Connectors (S3200 is the Part No. prefix.)

	SYSMAC NET	SYSMAC LINK	SYSMAC WAY	SYSMAC BUS/2	SYSMAC BUS
C200H	COCF2511	COCF2511	COCH82	—	COCH82
C1000H, C2000H	COCH62M	COCF2011	COCH82	—	COCH82
CVM1, CV500, CV1000, CV2000	COCF2011	COCF2011	COCF2011	COCF2011	COCF2011
SYSMAC NET Network Support Board	COCH62M	—	—	—	—
SYSMAC NET Line Server	COCH62M	—	—	—	—
SYSMAC NET Bridge	COCH62M	—	—	—	—
SYSMAC NET Network Service Unit	COCH62M	—	—	—	—
SYSMAC NET VME Interface	COCH62M	—	—	—	—

3G5A2 Connectors (-P modules only) 3G5A2 is the Part No. prefix. B500 Part No. prefixes are equivalent to 3G5A2 prefixes.

	SYSMAC WAY	SYSMAC BUS
C200H	CO001, CO002	CO001, CO002
C1000H, C2000H	CO001, CO002	CO001, CO002
CVM1, CV500, CV1000, CV2000	—	CO001, CO002

All Plastic Fiber-optic (APF) Cable

ITEM	DESCRIPTION	PART NUMBER
Fiber-optic Cable	20 m (65.6 ft.), without connectors	B500-PF212
Fiber-optic Connectors	Brown, for cable 0 to 10 m (0 to 32.8 ft.) long (includes 2)	3G5A2-CO001
	Black, for cable 8 to 20 m (0 to 65.6 ft.) long (includes 2)	3G5A2-CO002

Hard Plastic-Clad Fiber-optic (HPCF) Cable

ITEM	DESCRIPTION	PART NUMBER
Fiber-optic Cable	50 m (164 ft.), without connectors	FCS-HCR-LB-501
	100 m (328 ft.), without connectors	FCS-HCR-LB-102
	500 m (0.31 mile), without connectors	FCS-HCR-LB-502
	1 km (0.62 mile), without connectors	FCS-HCR-LB-103
	Zipcord style, orange, 50 m (164 ft.), without connectors	FCS-HCR-CO-501
Fiber-optic Connectors	SYSMAC BUS or SYSMAC WAY only	S3200-COCH82
	SYSMAC BUS/2 (all PLCs), SYSMAC LINK (other than C200H)	S3200-COCF2011
	SYSMAC NET (other than C200H)	S3200-COCH62M
	SYSMAC NET, LINK (C200H only)	S3200-COCF2511
In-line Fiber-optic Connectors	SYSMAC NET In-line male connector	S3200-COCF62M
	SYSMAC NET In-line female connector	S3200-COCF62F
	SYSMAC LINK In-line adapter	S3200-COAT2000
Termination Kit	For HPCF Cable	FCS-CAK6230-US



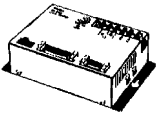

Plastic-Clad Fiber-optic (PCF) Cable

ITEM	DESCRIPTION	PART NUMBER
Indoor Fiber-optic Cable	10 cm (0.32 ft.), with connectors	3G5A2-OF011
	1 m (3.2 ft.), with connectors	3G5A2-OF101
	2 m (6.56 ft.), with connectors	3G5A2-OF201
	3 m (9.8 ft.), with connectors	3G5A2-OF301
	5 m (16.4 ft.), with connectors	3G5A2-OF501
	10 m (32.8 ft.), with connectors	3G5A2-OF111
	20 m (65.6 ft.), with connectors	3G5A2-OF211
	30 m (98 ft.), with connectors	3G5A2-OF311
	50 m (164 ft.), with connectors	3G5A2-OF511
Indoor/Outdoor Fiber-optic Cable	100 m (328 ft.), with connectors	3G5A2-OF002-100M
	200 m (656 ft.), with connectors	3G5A2-OF002-200M
	400 m (0.25 mile), with connectors	3G5A2-OF002-400M
	800 m (0.5 mile), with connectors	3G5A2-OF002-800M



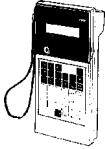

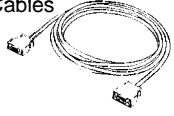
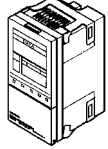



LINK ADAPTERS

ITEM	DESCRIPTION	PART NUMBER	STANDARDS
Link Adapters 	3 RS-422 connectors	3G2A9-AL001	N, L
	3 fiber-optic connectors (APF/PCF)	3G2A9-AL002-PE	N
	3 fiber-optic connectors (PCF)	3G2A9-AL002-E	
	1 connector for RS-232C; 2 for RS-422	3G2A9-AL003	---
	1 connector each for APF/PCF, RS-422, and RS-232C	3G2A9-AL004-PE	N, L
	1 connector each for PCF, RS-422, and RS-232C	3G2A9-AL004-E	
	1 connector each for APF/PCF and APF	3G2A9-AL005-PE	---
	1 connector each for PCF and AGF	3G2A9-AL005-E	
	1 connector for APF/PCF; 2 for AGF	3G2A9-AL006-PE	
	1 connector for PCF; 2 for AGF	3G2A9-AL006-E	N, L
	O/E converter; 1 connector for RS-485, 1 connector each for APF/PCF	B500-AL007-P	
	Used for on-line removal of SYSMAC NET Link Units from the SYSMAC NET Link System, SYSMAC NET Fiber-optic Link Adapter (3 connectors for APF/PCF)	B700-AL001	---



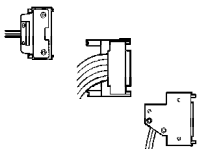

PROGRAMMING DEVICES

ITEM	DESCRIPTION	PART NUMBER	STANDARDS	
Programming Consoles 	Provided with a 2-m cable for ladder programming One of the following connection cables is required for ladder programming.	C200H-PRO27-E	U, C	
		CQM1-PRO01-E		
Programming Console Mounting Bracket 	Used to attach Hand-held Programming Console to a panel.	C200H-ATT01	---	
Programming Console Connecting Cables 	For C200H-PRO27-E Hand-held Programming Console	2 m	C200H-CN222	
			C200HS-CN222	CE
		4 m	C200H-CN422	---
			C200HS-CN422	CE
Data Setting Console 	Used for data input and process value display for the C200H-TC□□□□.	C200H-DSC01	---	
Data Setting Console Connecting Cables	For C200H-DSC01	2 m	C200H-CN225	
		4 m	C200H-CN425	
Connecting Cable 	Used to connect an IBM PC/AT or compatible to the C200HX/HG/HE.	3.3 m	CQM1-CIF02	

OPTIONAL PRODUCTS

ITEM	DESCRIPTION	PART NUMBER	STANDARDS
I/O Module Cover 	Cover for 10-pin terminal block	C200H-COV11	---
Terminal Block Covers 	Short protection for 10-pin terminal block (package of 10 covers); 8 pts	C200H-COV02	
	Short protection for 19-pin terminal block (package of 10 covers); 12 pts	C200H-COV03	
Connector Cover 	Protective cover for unused I/O Connecting Cable connectors	C500-COV02	
Space Module 	Used for vacant slots	C200H-SP001	N, L
Battery Set 	For C200H or C200HS RAM Memory Unit only	C200H-BAT09	---
Relay 	24 VDC	G6B-1174P-FD-US	
CPU Backplane Insulation Plates 	For 3-slot Backplane	C200H-ATT31	---
	For 5-slot Backplane	C200H-ATT51	
	For 8-slot Backplane	C200H-ATT81	
	For 10-slot Backplane	C200H-ATTA1	
I/O Backplane Insulation Plates 	For 3-slot Backplane	C200HW-ATT32	N
	For 5-slot Backplane	C200HW-ATT52	
	For 8-slot Backplane	C200HW-ATT82	---
	For 10-slot Backplane	C200HW-ATTA2	
External Connectors 	Solder terminal; 40p and a Connector Cover	C500-CE401	
	Solderless terminal; 40p and a Connector Cover (Crimp-type)	C500-CE402	
	Pressure welded terminal; 40p	C500-CE403	
	Solder terminal; 40p and a Connector Cover (Horizontal-type)	C500-CE404	
	Crimp-style terminal; 40p and a Connector Cover (Horizontal-type)	C500-CE405	

MOUNTING RAIL AND MOUNTING ACCESSORIES

ITEM	DESCRIPTION	PART NUMBER	STANDARDS
DIN Rail Mounting Bracket 	1 set (2 included)	C200H-DIN01	---
DIN Rails 	Length: 50 cm; height: 7.3 cm	PFP-50N	
	Length: 1 m; height: 7.3 cm	PFP-100N	
	Length: 1 m; height: 16 mm	PFP-100N2	
End Plate 	---	PFP-M	
Spacer 	---	PFP-S	

Note: Order DIN Rails, End Plates, and Spacers in units of 10 each.

SOFTWARE

SYSMAC Support Software (SSS)

ITEM	DESCRIPTION	PART NUMBER
SYSMAC Support Software (for C20, C□□P, C□□K, C120, C□□H, C200H, C200HS, C200HE, C200HG, C200HX, C500, C1000H, C2000H, CQM1, and CVM1) 	3.5", 2HD for IBM PC/AT compatible	C500-ZL3AT1-EV1.2

SYSWIN

ITEM	DESCRIPTION	PART NUMBER
SYSWIN (for C20, C□□P, C□□K, C120, C□□H, C200H, C200HS, C200HE, C200HG, C200HX, C500, C1000H, C2000H, CQM1, and CVM1) 	3.5", 2HD for IBM PC/AT compatible	SYSWINHL-V3.0

Protocol Support Software (PSS)

ITEM	DESCRIPTION	PART NUMBER
Protocol Support Software 	3.5", 2HD for IBM PC/AT compatible	C200HW-ZW3AT1-E

Motion Control Support Software (MCSS) – for C200H-MC221 Motion Control Module ONLY

ITEM	DESCRIPTION	PART NUMBER
Motion Control Support Software 	3.5", 2HD for IBM PC/AT compatible	CV500-ZN3AT1-E

PLC Installation, Operation

ITEM	DESCRIPTION	PART NUMBER
C200HX/C200HG/C200HE PLCs	Installation Guide	W302
C200HX/C200HG/C200HE PLCs	Operation Guide	W303
C200HW-COM01-C200HW-COM06-E	Operation Guide	W304
C200HW-ZW3AT1-E Protocol Software	Operation Guide	W305

Special I/O Modules

ITEM	DESCRIPTION	PART NUMBER
C200H-PCU01/PCS01	PC Card Module	W313
C200H-ASC02	ASCII/BASIC Module	W165
C200H-AD001, C200H-DA001	Analog I/O Modules	W127
C200H-AD002	Analog Input Module	W229
C200H-DA002	Analog Output Module	W260
C200H-CT001-V1/CT002	High-speed Counter Modules	W141
C200H-CT021	High-speed Counter Modules	W311
C200H-TS001/TS002	Temperature Sensor Input Modules	W124
C200H-TC□□□□	Temperature Control Module	W225
C200H-TV□□□□	Heat/Cool Temperature Control Module	W240
C200H-PID□□□	PID Control Module	W241
C200H-CP114	Cam Positioner Module	W224
C200H-NC111	Position Control Module	W137
C200H-NC112	Position Control Module	W128
C200H-NC221	Position Control Module	W166
C200H-IDS01/IDS21	ID Sensor Module	W153
C200H-OV001	Voice Module	W172
C200H-MC221	Motion Module	W314 / W315 / W256
C200H-FZ001	Fuzzy Logic Module	W208

Communications

ITEM	DESCRIPTION	PART NUMBER
C200HW-SLK□□	SYSMAC Link Modules	W174
C200HS-SNT32	SYSMAC Net Module	W114
C200H-LK401	PC Link Module	W135
C200H-LK20□	Host Link Modules	W143
SYSBUS Wired Remote I/O	System manual	W120
SYSBUS Fiber-Optic Remote I/O	System manual	W136
DeviceNet	System manual	W267

Peripheral Devices

ITEM	DESCRIPTION	PART NUMBER
C200H-DAC01		W173
GPC (Graphics Programming Console)	Operation manual	W84
FIT (Factory Intelligent Terminal)	Operation manual	W150
Printer Interface Module	Operation manual	W107
PROM Writer Operation Guide	Procedures for programming EPROM	W155
Floppy Disk Interface Module	Procedures for interfacing with floppy disk	W119

Programming Software

ITEM	DESCRIPTION	PART NUMBER
SYSMAC Support Software	Programming procedures using SSS	W247/W248
SYSWIN Support Software	Programming procedures using SYSWIN	SYSWIN-EMAN-V□□



COMPLEMENTARY
PRODUCTS

Operator Interface Terminals

141

142



OPERATOR INTERFACE TERMINALS

Easy to order, with no complicated configuration (communications and memory are built-in), the NT Series Terminals provide a variety of control options. From the basic 4 line x 20 character, text-based NT11S to our graphic touch screen models — including the slim NT20S (with a depth of only 54 mm) and the eight-color NT620C — our new line of terminals can be relied on for clear, dependable data presentation. And with Omron's Host Link and NT Link communication methods, fast response times between terminal and PLC are guaranteed. Direct connection to the C200H backplane is also available on some models for an even faster response. Combine this with Omron's NT Support Software and you get a powerful operator interface that's easy to read and quick to connect with screens that are simple to create.



MODEL	NT11S	NT20S	NT30	NT30C
DISPLAY				
Size	4 line x 20 character	5" diagonal	5.7" diagonal	5.7" diagonal
Type	Backlit LCD	Backlit STN LCD	Bicolor backlit STN LCD	8-color backlit STN LCD
Resolution	160 x 64 pixels	256 x 128 pixels	320 x 240 pixels	320 x 240 pixels
Interface	Alphanumeric	Touch screen	Touch screen	Touch screen
Touch cells	—	72 per screen	192 per screen	192 per screen
FEATURES				
	Large characters	Slim profile	Bicolor display	8-color display
	Contrast control	Easy to configure screens	Full graphic capabilities	Full graphic capabilities
	Password protect screens	Replaceable backlight	Replaceable backlight	Replaceable backlight
MEMORY				
Type	Flash EPROM	Flash EPROM	Flash EPROM	Flash EPROM
Size	32 K	64-92 K	512 K	512 K
Max. # of screens	250 screens	250 screens	2000 screens	2000 screens
GRAPHIC CAPABILITIES				
Freeform drawing		■	■	■
Bitmap			■	■
Tiling			■	■
Bar graph	■	■	■	■
Line trending			■	■
Thumbwheel switch		■	■	■
Text and numeric	■	■	■	■
Real-Time Clock			■	■
Printer Port	■		■	■
Communication	Host Link / NT Link	Host Link / NT Link / C200H Interface	Host Link / NT Link	Host Link / NT Link
Overall Dimensions	218 _W x 113 _H x 38.2 _D mm 8.58 _W x 4.45 _H x 1.50 _D in	190 _W x 110 _H x 58 _D mm 7.48 _W x 4.33 _H x 2.28 _D in	195 _W x 142 _H x 55.6 _D mm 7.68 _W x 5.59 _H x 2.19 _D in	195 _W x 142 _H x 55.6 _D mm 7.68 _W x 5.59 _H x 2.19 _D in
ENVIRONMENTAL				
Ratings	NEMA 4	NEMA 4	NEMA 4	NEMA 4
Approvals	UL / CSA	UL / CSA	UL / CSA	UL / CSA
Accessories	—	Backlight Chemical resistant cover Protective sheet C200H Interface	Backlight Chemical resistant cover Protective sheet B7A Interface	Backlight Chemical resistant cover Protective sheet B7A Interface

OPERATOR INTERFACE TERMINALS

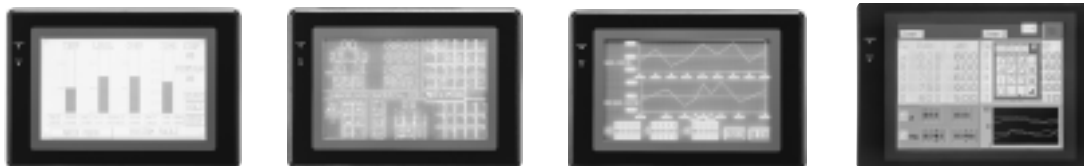

MODEL	NT600S (LCD)	NT600S (EL)	NT620S	NT620C
DISPLAY				
Size	9" diagonal	9" diagonal	9" diagonal	9.7" diagonal
Type	Backlit STN LCD	Electroluminescent	Electroluminescent	8-color backlit STN LCD
Resolution	640 x 400 pixels	640 x 400 pixels	640 x 400 pixels	640 x 480 pixels
Interface	Touch screen	Touch screen	Touch screen	Touch screen
Touch cells	128 per screen	128 per screen	512 per screen	768 per screen
FEATURES				
	Large screen	Clear EL display	Clear EL display	8-color display
	Slim profile	Extra-wide viewing angle	Full graphic capabilities	Full graphic capabilities
	Replaceable backlight	Slim profile	Extra-wide viewing angle	Replaceable backlight
MEMORY				
Type	Flash EPROM	Flash EPROM	Flash EPROM	Flash EPROM
Size	128 K	128 K	512 K	1 MB
Max. # of screens	500 screens	500 screens	2000 screens	2000 screens
GRAPHIC CAPABILITIES				
Freeform drawing	■	■	■	■
Bitmap			■	■
Tiling			■	■
Bar graph	■	■	■	■
Line trending			■	■
Thumbwheel switch	■	■	■	■
Text and numeric	■	■	■	■
Real-Time Clock			■	■
Printer Port			■	■
Communication	Host Link / NT Link C200H Interface	Host Link / NT Link / C200H Interface	Host Link / NT Link	Host Link / NT Link
Overall Dimensions	275 _W x 192 _H x 71 _D mm 10.83 _W x 7.56 _H x 2.80 _D in	275 _W x 192 _H x 71 _D mm 10.83 _W x 7.56 _H x 2.80 _D in	275 _W x 192 _H x 71 _D mm 10.83 _W x 7.56 _H x 2.80 _D in	275 _W x 196 _H x 76.8 _D mm 10.83 _W x 7.72 _H x 3.02 _D in
ENVIRONMENTAL				
Ratings	NEMA 4	NEMA 4	NEMA 4	NEMA 4
Approvals	UL / CSA	UL / CSA	UL / CSA	UL / CSA
Accessories				
	Backlight	Chemical resistant cover	Chemical resistant cover	Backlight
	Chemical resistant cover	Protective sheet	Protective sheet	Chemical resistant cover
	Protective sheet	C200H Interface		Protective sheet
	C200H Interface			

OPERATOR INTERFACE TERMINAL

COMMUNICATIONS OPTIONS

Direct Access Function greatly reduces programming effort of the host. The Direct Access Function enables the user to directly access the relay area and DM area of the Host. Using this function, the user can greatly reduce the PLC programming effort that is required for the Operator Interface Terminals. The C200HX/HG/HE Interface and NT Link are ideal for applications that require high-speed input operations.

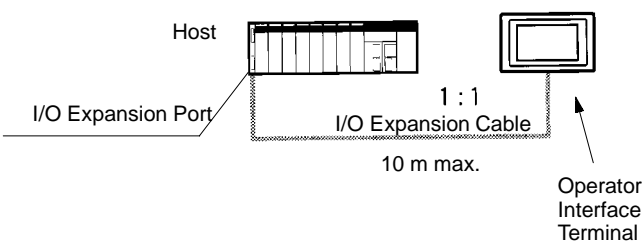
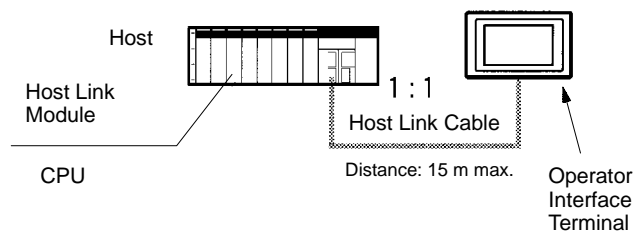
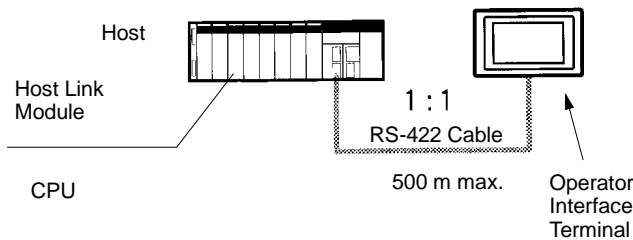
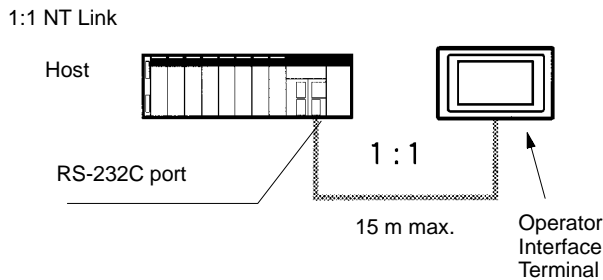

NT Link

- Greatly reduces ladder programming required for controlling the Operator Interface Terminals.
- Enables a faster I/O response by using a dedicated communications protocol.

RS-422 Host Link Connection

- Greatly reduces ladder programming required for controlling the Operator Interface Terminals.
- Ideal for a long-distance transmission with 1:1 connection.

RS-232C Host Link Connection

- Greatly reduces ladder programming required for controlling the Operator Interface Terminals.
- One of the most popular communications systems.

C200H Backplane Connection

- Greatly reduces ladder programming required for controlling the Operator Interface Terminals.
- Directly connects to the I/O expansion port of the C200HX/HG/HE to achieve faster response and high-speed display.
- No Communications Units are required on the C200HX/HG/HE side.

OPERATOR INTERFACE TERMINAL

COMMUNICATIONS OPTIONS

Communications Methods Applicable to C200HX/HG/HE

- ★ Possible to connect to the I/O expansion port
- Possible to use from the Communications Module built into the CPU (see note)
- Possible to connect to the Communications Module

PLC	DIRECT ACCESS FUNCTION			
	RS-232C HOST LINK CONNECTION	C200H BACKPLANE CONNECTION	NT LINK	RS-422 HOST LINK CONNECTION
C200HX/HG/HE	●/○	★	○	●/○

Note: C200HE-CPU42-E, C200HG-CPU43-E/63-E, and C200HX-CPU44-E/64-E allow connection to the built-in port.

Communications Methods of the NT Series

OPERATOR INTERFACE TERMINAL	DIRECT ACCESS FUNCTION			
	RS-232C HOST LINK CONNECTION	C200H BACKPLANE CONNECTION	NT LINK	RS-422 HOST LINK CONNECTION
NT11S	Yes	---	Yes	Yes
NT20S	Yes	Yes	Yes	---
NT30/C	Yes	---	Yes	Yes
NT600S	Yes	Yes	Yes	---
NT620S/C	Yes	---	Yes	---

I/O BLOCKS

Connecting to High-density I/O Modules

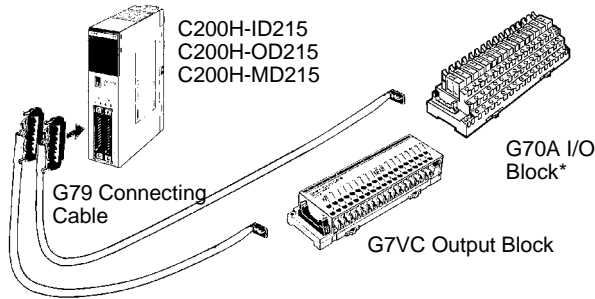

I/O Blocks Connect to High-density I/O Modules, Mixed I/O Modules and Normal I/O Modules

G70A I/O Blocks

- G70A I/O Blocks provide 16 contact input or 16 contact output points in a compact package (234 x 75 x 64 mm).
- They mount to DIN track to save installation and maintenance time.

G7VC Output Blocks

- G7VC Output Blocks provide 16 output points in a compact package (192 x 58 x 38.5 mm).
- A rotating front cover provides easy access to terminals for simplified maintenance and increased safety.

Connecting to Group-2 I/O Modules

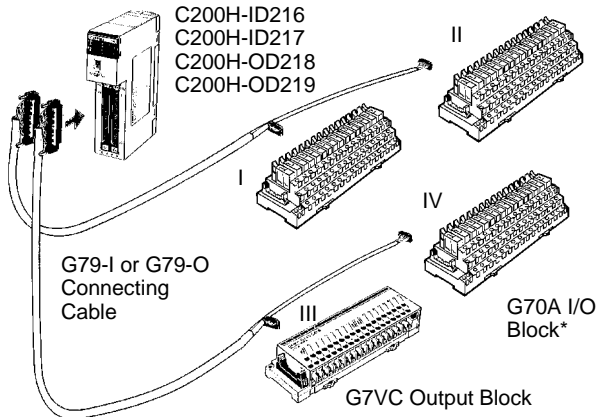

Note: I to IV indicate connector numbers.

Connecting to I/O Modules Equipped with Connectors

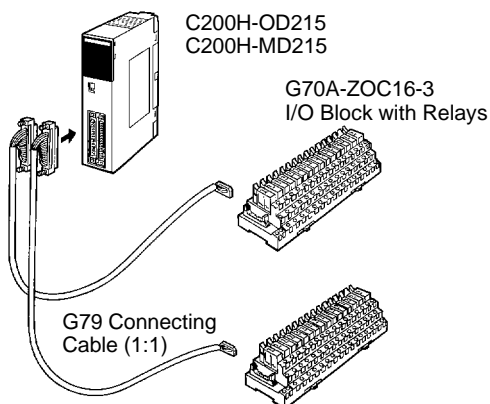

G72C/G72C-V I/O TERMINALS

G72C/G72C-V I/O Terminals In Remote I/O Systems

I/O Terminals are connected as Slaves in Remote I/O Systems to provide for special wiring needs via wiring blocks. Compactness in the right shape is provided by a choice between flat terminals (182 x 85 x 45 mm) and vertical terminals (202 x 45 x 63 mm).

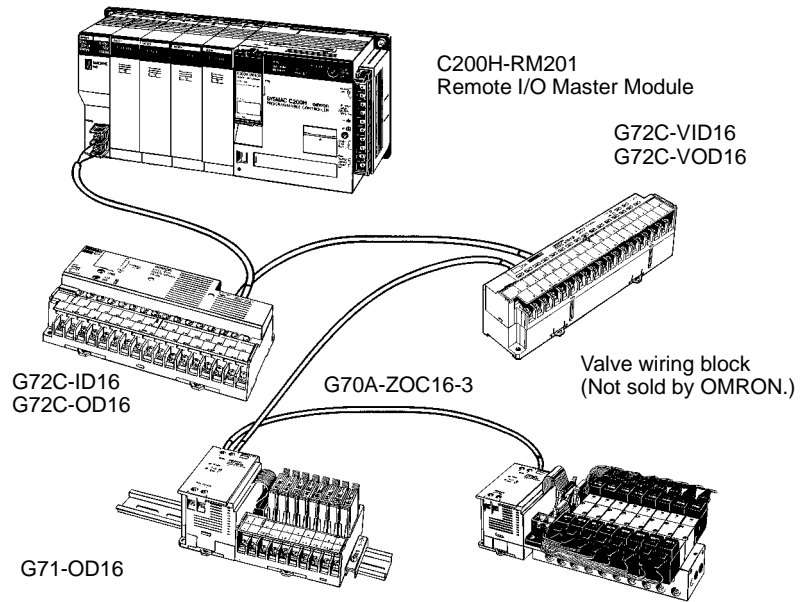

Note: Ask your OMRON dealer for more information concerning OMRON I/O Blocks and I/O Terminals.

CONNECTOR TERMINAL CONVERSION UNITS/CABLES

Connecting Cables

For 32-point I/O Modules with Connectors:

XW2Z-□□□A

Note: The G79-□C (Cable for G7TC) cannot be used for the XW2C.

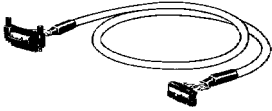

For 32-point I/O Modules with Connectors (Group-2 Slaves) or

For 64-point I/O Modules with Connectors :

XW2Z-□□□B

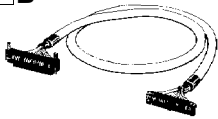

For 32-point Input Modules with Connectors (Group-2 Slaves) or

For 64-point Input Modules with Connectors :

XW2Z-□□□D

Note: The G79-1□C-□ (Cable for G7TC) cannot be used for the XW2C.



Cable with Loose Crimp Connectors (20 connections) :

XW2Z-□□□F

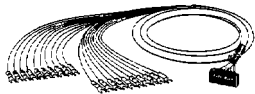

You Can Easily Convert Between Connectors and Terminal Blocks to Simplify Control Wiring.

XW2B

- Only 45 mm wide, the XW2B connects directly to PLC I/O
- Modules using special cables to simplify connection.
- Snap onto DIN rail or mount with screws.
- Easy panel-mounting.

XW2Z

- A special cable for easy connection between PLC I/O Modules and Connector-Terminal Conversion Units

Connection Examples

32-point PLC I/O Modules with Connectors

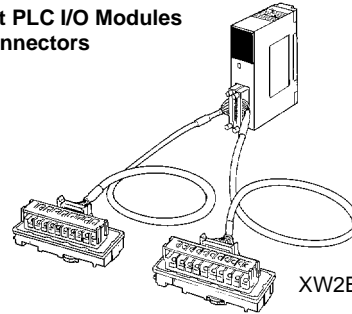

C200H-ID215
C200H-OD215
C200H-MD115
C200H-MD215
C200H-MD501
C200H-ID501
C200H-OD501

XW2Z-□□□A
Connecting Cable

XW2B-20G□

32-point I/O Modules with Connectors (Group-2 Slaves)
64-point I/O Modules with Connectors (Group-2 Slaves)

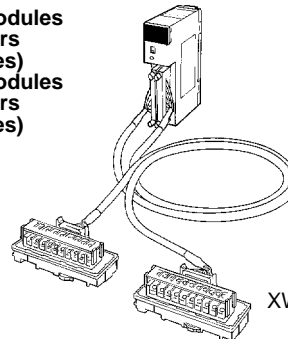

C200H-ID216
C200H-OD218
C200H-ID217
C200H-OD219

XW2B-40G□

I/O Modules with Terminal Blocks

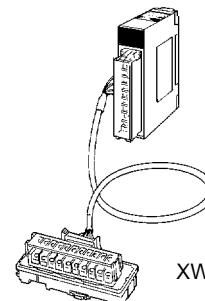

XW2Z-□□□F
Cable with Loose Crimp Connectors

XW2B-20G□

PART NUMBER INDEX

