

Complementary Power Transistors

DPAK for Surface Mount Applications

MJD41C (NPN), MJD42C (PNP)

Designed for general purpose amplifier and low speed switching applications.

Features

- Lead Formed for Surface Mount Applications in Plastic Sleeves (No Suffix)
- Straight Lead Version in Plastic Sleeves ("1" Suffix)
- Electrically Similar to Popular TIP41 and TIP42 Series
- Epoxy Meets UL 94 V-0 @ 0.125 in
- NJV Prefix for Automotive and Other Applications Requiring Unique Site and Control Change Requirements; AEC-Q101 Qualified and PPAP Capable
- These Devices are Pb-Free and are RoHS Compliant

MAXIMUM RATINGS

Rating	Symbol	Max	Unit
Collector-Emitter Voltage	V_{CEO}	100	Vdc
Collector-Base Voltage	V_{CB}	100	Vdc
Emitter-Base Voltage	V_{EB}	5	Vdc
Collector Current - Continuous	I_C	6	Adc
Collector Current - Peak	I_{CM}	10	Adc
Base Current	I_B	2	Adc
Total Power Dissipation @ $T_C = 25^\circ\text{C}$ Derate above 25°C	P_D	20 0.16	W W/ $^\circ\text{C}$
Total Power Dissipation (Note 1) @ $T_A = 25^\circ\text{C}$ Derate above 25°C	P_D	1.75 0.014	W W/ $^\circ\text{C}$
Operating and Storage Junction Temperature Range	T_J, T_{stg}	-65 to +150	$^\circ\text{C}$
ESD - Human Body Model	HBM	3B	V
ESD - Machine Model	MM	C	V

Stresses exceeding those listed in the Maximum Ratings table may damage the device. If any of these limits are exceeded, device functionality should not be assumed, damage may occur and reliability may be affected.

1. These ratings are applicable when surface mounted on the minimum pad sizes recommended.

SILICON POWER TRANSISTORS 6 AMPERES 100 VOLTS, 20 WATTS

COMPLEMENTARY

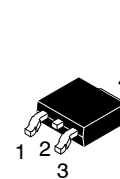
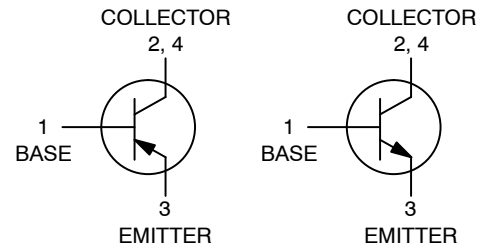

DPAK
CASE 369C
STYLE 1

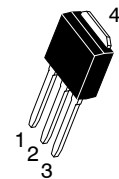

IPAK
CASE 369D
STYLE 1

MARKING DIAGRAMS

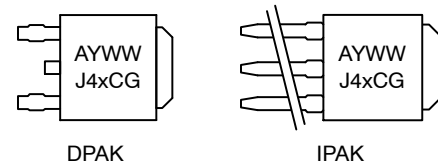

DPAK

IPAK

- A = Assembly Location
- Y = Year
- WW = Work Week
- J4xC = Device Code
x = 1 or 2
- G = Pb-Free Package

ORDERING INFORMATION

See detailed ordering and shipping information in the package dimensions section on page 5 of this data sheet.

NOTE: Some of the devices on this data sheet have been **DISCONTINUED**. Please refer to the table on page 5.

MJD41C (NPN), MJD42C (PNP)

THERMAL CHARACTERISTICS

Characteristic	Symbol	Max	Unit
Thermal Resistance, Junction-to-Case	$R_{\theta JC}$	6.25	$^{\circ}C/W$
Thermal Resistance, Junction-to-Ambient (Note 2)	$R_{\theta JA}$	71.4	$^{\circ}C/W$

2. These ratings are applicable when surface mounted on the minimum pad sizes recommended.

ELECTRICAL CHARACTERISTICS ($T_C = 25^{\circ}C$ unless otherwise noted)

Characteristic	Symbol	Min	Max	Unit
----------------	--------	-----	-----	------

OFF CHARACTERISTICS

Collector-Emitter Sustaining Voltage (Note 3) ($I_C = 30 \text{ mAdc}$, $I_B = 0$)	$V_{CE(sus)}$	100	-	Vdc
Collector Cutoff Current ($V_{CE} = 60 \text{ Vdc}$, $I_B = 0$)	I_{CEO}	-	50	μAdc
Collector Cutoff Current ($V_{CE} = 100 \text{ Vdc}$, $V_{EB} = 0$)	I_{CES}	-	10	μAdc
Emitter Cutoff Current ($V_{BE} = 5 \text{ Vdc}$, $I_C = 0$)	I_{EBO}	-	0.5	mAdc

ON CHARACTERISTICS (Note 3)

DC Current Gain ($I_C = 0.3 \text{ Adc}$, $V_{CE} = 4 \text{ Vdc}$) ($I_C = 3 \text{ Adc}$, $V_{CE} = 4 \text{ Vdc}$)	h_{FE}	30 15	- 75	-
Collector-Emitter Saturation Voltage ($I_C = 6 \text{ Adc}$, $I_B = 600 \text{ mAdc}$)	$V_{CE(sat)}$	-	1.5	Vdc
Base-Emitter On Voltage ($I_C = 6 \text{ Adc}$, $V_{CE} = 4 \text{ Vdc}$)	$V_{BE(on)}$	-	2	Vdc

DYNAMIC CHARACTERISTICS

Current Gain – Bandwidth Product (Note 4) ($I_C = 500 \text{ mAdc}$, $V_{CE} = 10 \text{ Vdc}$, $f_{test} = 1 \text{ MHz}$)	f_T	3	-	MHz
Small-Signal Current Gain ($I_C = 0.5 \text{ Adc}$, $V_{CE} = 10 \text{ Vdc}$, $f = 1 \text{ kHz}$)	h_{fe}	20	-	-

Product parametric performance is indicated in the Electrical Characteristics for the listed test conditions, unless otherwise noted. Product performance may not be indicated by the Electrical Characteristics if operated under different conditions.

3. Pulse Test: Pulse Width $\leq 300 \mu\text{s}$, Duty Cycle $\leq 2\%$.

4. $f_T = |h_{fe}| \cdot f_{test}$.

MJD41C (NPN), MJD42C (PNP)

TYPICAL CHARACTERISTICS

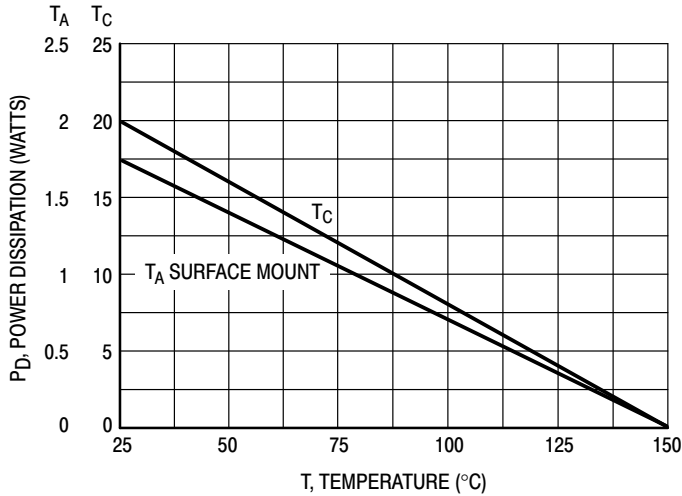
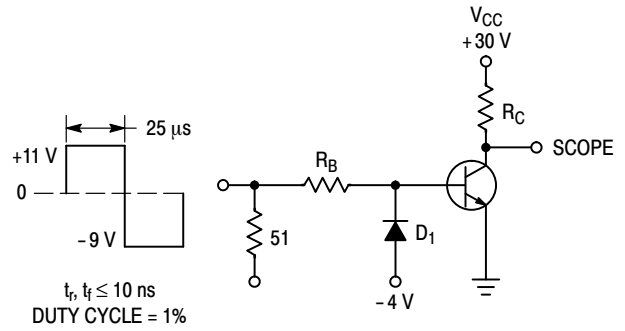

Figure 1. Power Derating



R_B and R_C VARIED TO OBTAIN DESIRED CURRENT LEVELS
 D_1 MUST BE FAST RECOVERY TYPE, e.g.:
 MSB5300 USED ABOVE $I_B \approx 100$ mA
 MSD6100 USED BELOW $I_B \approx 100$ mA
 REVERSE ALL POLARITIES FOR PNP.

Figure 2. Switching Time Test Circuit

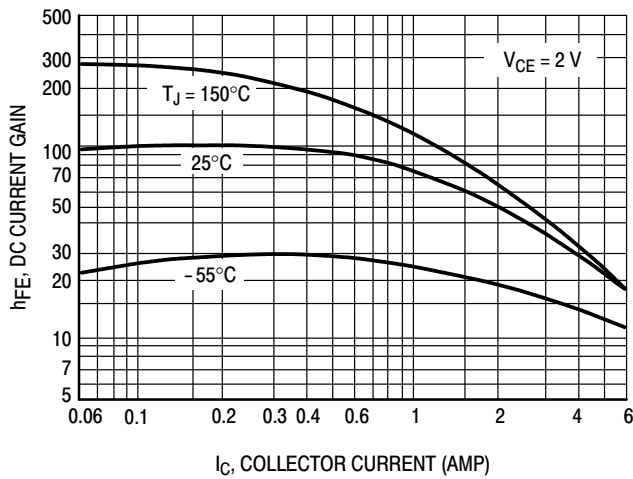

Figure 3. DC Current Gain

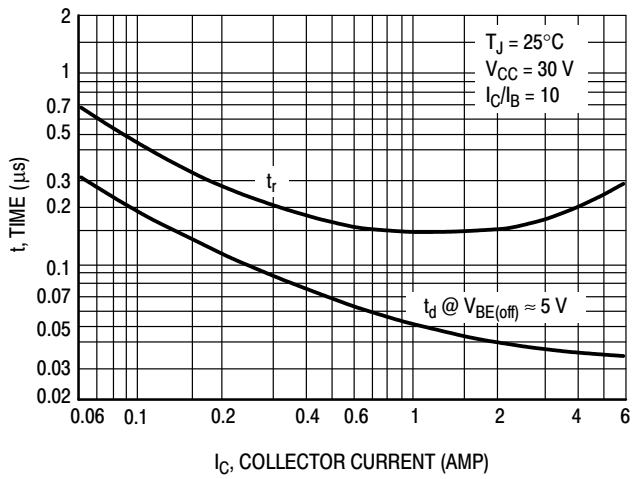

Figure 4. Turn-On Time

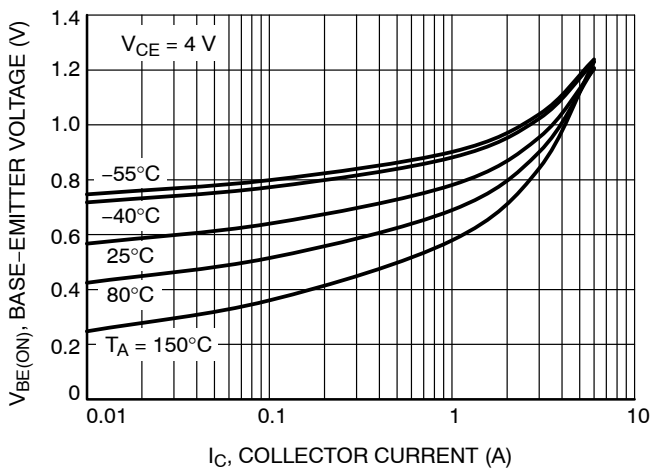

Figure 5. Base Emitter Voltage vs. Collector Current

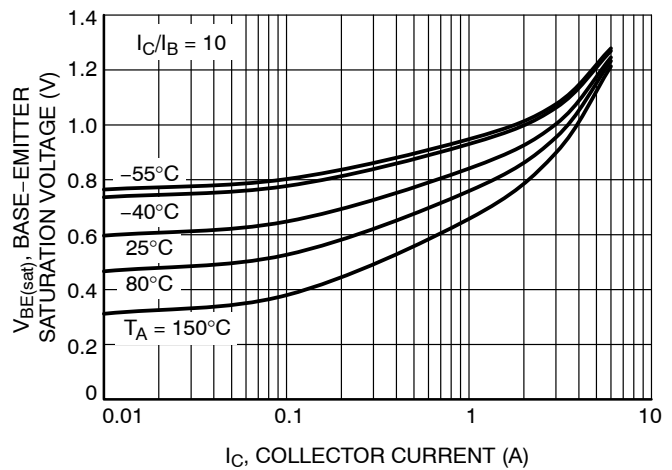

Figure 6. Base Emitter Saturation Voltage vs. Collector Current

MJD41C (NPN), MJD42C (PNP)

TYPICAL CHARACTERISTICS

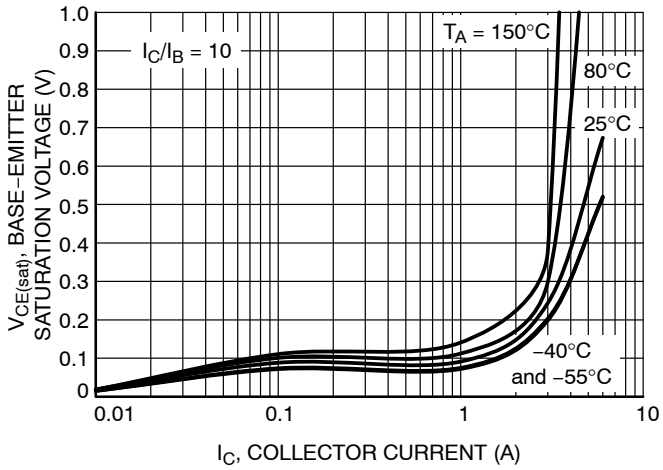

Figure 7. Collector Emitter Saturation Voltage vs. Collector Current

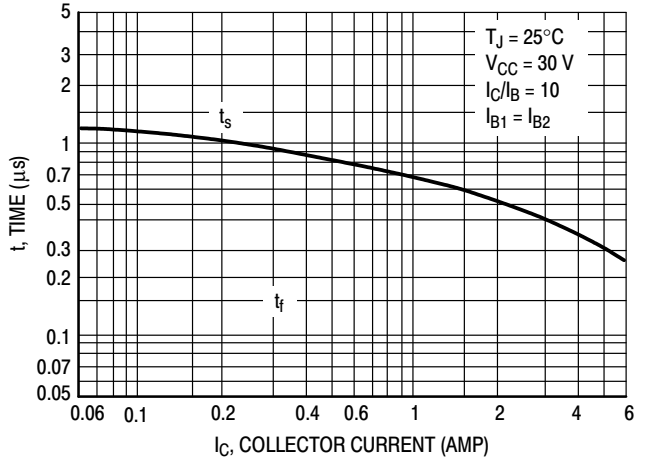

Figure 8. Turn-Off Time

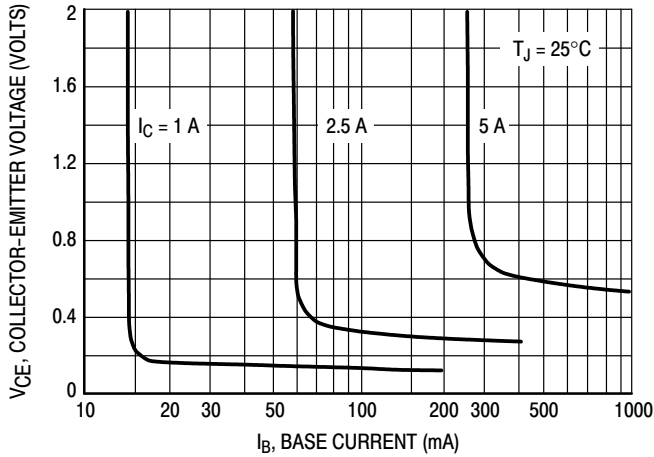

Figure 9. Collector Saturation Region

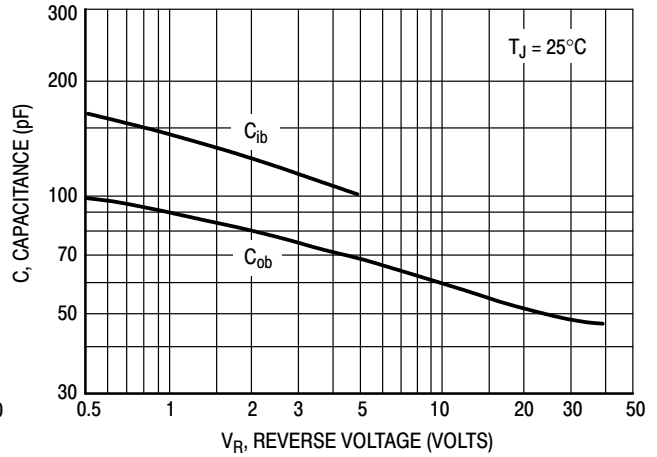

Figure 10. Capacitance

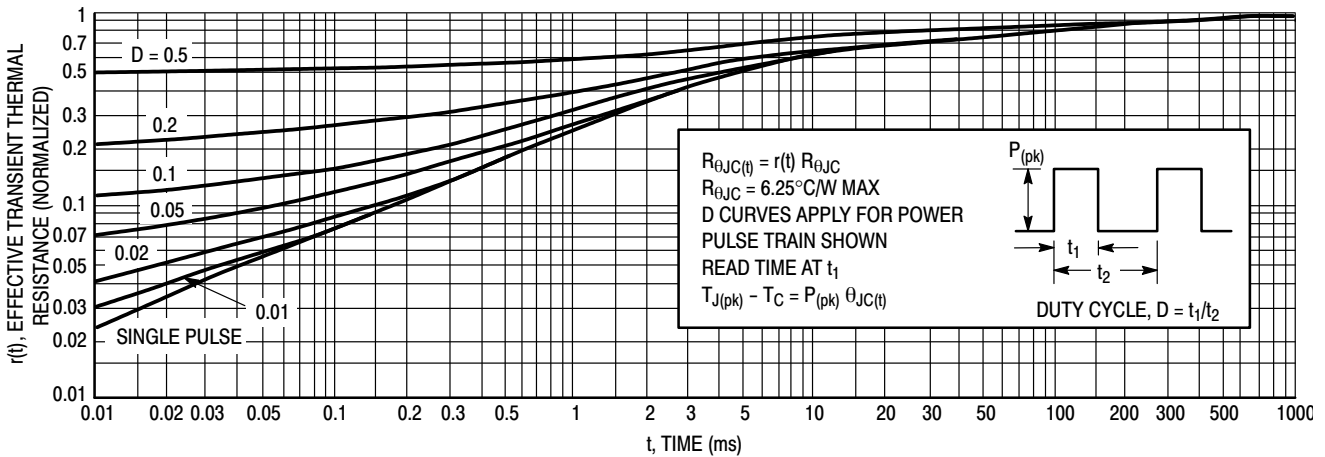

Figure 11. Thermal Response

MJD41C (NPN), MJD42C (PNP)

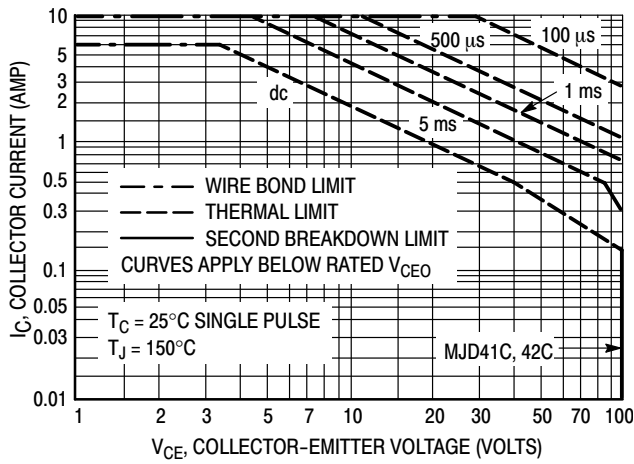

Figure 12. Maximum Forward Bias Safe Operating Area

There are two limitations on the power handling ability of a transistor: average junction temperature and second breakdown. Safe operating area curves indicate $I_C - V_{CE}$ limits of the transistor that must be observed for reliable operation; i.e., the transistor must not be subjected to greater dissipation than the curves indicate.

The data of Figure 12 is based on $T_{J(pk)} = 150^\circ\text{C}$; T_C is variable depending on conditions. Second breakdown pulse limits are valid for duty cycles to 10% provided $T_{J(pk)} \leq 150^\circ\text{C}$. $T_{J(pk)}$ may be calculated from the data in Figure 11. At high case temperatures, thermal limitations will reduce the power that can be handled to values less than the limitations imposed by second breakdown.

ORDERING INFORMATION

Device	Package Type	Package	Shipping [†]
MJD41CRLG	DPAK (Pb-Free)	369C	1,800 / Tape & Reel
MJD41CT4G	DPAK (Pb-Free)	369C	2,500 / Tape & Reel
NJVMJD41CT4G*	DPAK (Pb-Free)	369C	2,500 / Tape & Reel
MJD42CG	DPAK (Pb-Free)	369C	75 Units / Rail
MJD42CRLG	DPAK (Pb-Free)	369C	1,800 / Tape & Reel
NJVMJD42CRLG*	DPAK (Pb-Free)	369C	1,800 / Tape & Reel
MJD42CT4G	DPAK (Pb-Free)	369C	2,500 / Tape & Reel
NJVMJD42CT4G*	DPAK (Pb-Free)	369C	2,500 / Tape & Reel

DISCONTINUED (Note 5)

MJD42C1G	IPAK (Pb-Free)	369D	75 Units / Rail
----------	-------------------	------	-----------------

[†]For information on tape and reel specifications, including part orientation and tape sizes, please refer to our Tape and Reel Packaging Specifications Brochure, BRD8011/D.

*NJV Prefix for Automotive and Other Applications Requiring Unique Site and Control Change Requirements; AEC-Q101 Qualified and PPAP Capable

5. **DISCONTINUED:** This device is not recommended for new design. Please contact your **onsemi** representative for information. The most current information on this device may be available on www.onsemi.com.

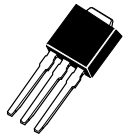

DPAK INSERTION MOUNT
CASE 369
ISSUE O

DATE 02 JAN 2000

SCALE 1:1

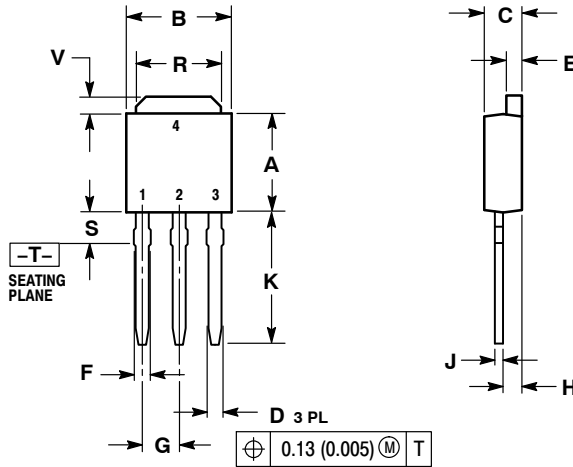

- NOTES:
1. DIMENSIONING AND TOLERANCING PER ANSI Y14.5M, 1982.
2. CONTROLLING DIMENSION: INCH.

DIM	INCHES		MILLIMETERS	
	MIN	MAX	MIN	MAX
A	0.235	0.250	5.97	6.35
B	0.250	0.265	6.35	6.73
C	0.086	0.094	2.19	2.38
D	0.027	0.035	0.69	0.88
E	0.033	0.040	0.84	1.01
F	0.037	0.047	0.94	1.19
G	0.090 BSC		2.29 BSC	
H	0.034	0.040	0.87	1.01
J	0.018	0.023	0.46	0.58
K	0.350	0.380	8.89	9.65
R	0.175	0.215	4.45	5.46
S	0.050	0.090	1.27	2.28
V	0.030	0.050	0.77	1.27

- | | | | | | |
|---|--|--|---|---|---|
| STYLE 1:
PIN 1. BASE
2. COLLECTOR
3. EMITTER
4. COLLECTOR | STYLE 2:
PIN 1. GATE
2. DRAIN
3. SOURCE
4. DRAIN | STYLE 3:
PIN 1. ANODE
2. CATHODE
3. ANODE
4. CATHODE | STYLE 4:
PIN 1. CATHODE
2. ANODE
3. GATE
4. ANODE | STYLE 5:
PIN 1. GATE
2. ANODE
3. CATHODE
4. ANODE | STYLE 6:
PIN 1. MT1
2. MT2
3. GATE
4. MT2 |
|---|--|--|---|---|---|

DOCUMENT NUMBER:	98ASB42319B	Electronic versions are uncontrolled except when accessed directly from the Document Repository. Printed versions are uncontrolled except when stamped "CONTROLLED COPY" in red.
DESCRIPTION:	DPAK INSERTION MOUNT	PAGE 1 OF 1

onsemi and ONSEMI are trademarks of Semiconductor Components Industries, LLC dba onsemi or its subsidiaries in the United States and/or other countries. onsemi reserves the right to make changes without further notice to any products herein. onsemi makes no warranty, representation or guarantee regarding the suitability of its products for any particular purpose, nor does onsemi assume any liability arising out of the application or use of any product or circuit, and specifically disclaims any and all liability, including without limitation special, consequential or incidental damages. onsemi does not convey any license under its patent rights nor the rights of others.

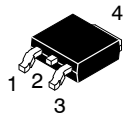

DPAK3 6.10x6.54x2.28, 2.29P
CASE 369C
ISSUE J

DATE 12 AUG 2025

SCALE 1:1

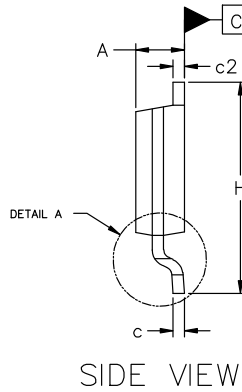
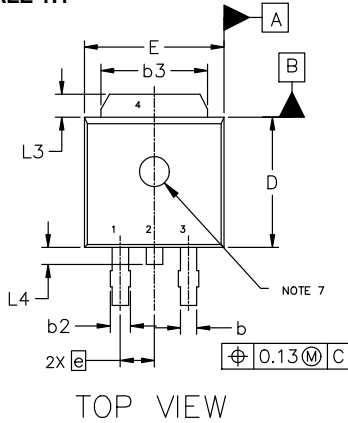

MILLIMETERS			
DIM	MIN	NOM	MAX
A	2.18	2.28	2.38
A1	0.00	---	0.13
b	0.63	0.76	0.89
b2	0.72	0.93	1.14
b3	4.57	5.02	5.46
c	0.46	0.54	0.61
c2	0.46	0.54	0.61
D	5.97	6.10	6.22
E	6.35	6.54	6.73
e	2.29 BSC		
H	9.40	9.91	10.41
L	1.40	1.59	1.78
L1	2.90 REF		
L2	0.51 BSC		
L3	0.89	---	1.27
L4	---	---	1.01
Z	3.93	---	---

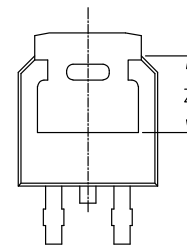
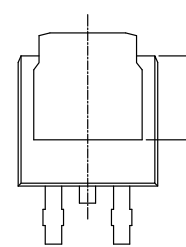
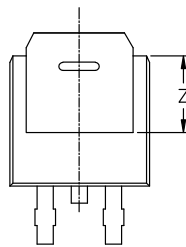
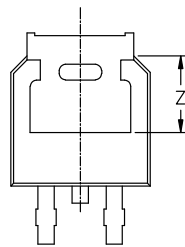
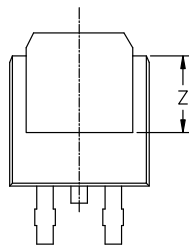

ALTERNATE CONSTRUCTIONS

NOTES:

1. DIMENSIONING AND TOLERANCING ASME Y14.5M, 2018.
2. CONTROLLING DIMENSION: MILLIMETERS.
3. THERMAL PAD CONTOUR OPTIONAL WITHIN DIMENSIONS b3, L3, AND Z.
4. DIMENSIONS D AND E DO NOT INCLUDE MOLD FLASH, PROTRUSIONS, OR BURRS. MOLD FLASH, PROTRUSIONS, OR GATE BURRS SHALL NOT EXCEED 0.15mm PER SIDE.
5. DIMENSIONS D AND E ARE DETERMINED AT THE OUTERMOST EXTREMES OF THE PLASTIC BODY.
6. DATUMS A AND B ARE DETERMINED AT DATUM PLANE H.
7. OPTIONAL MOLD FEATURE.

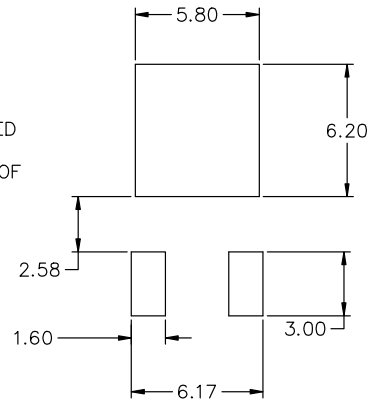
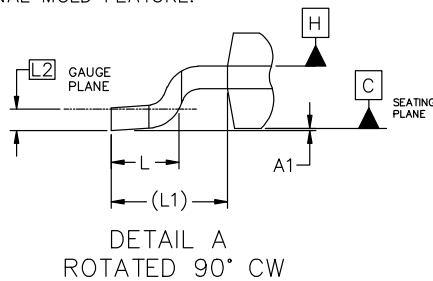

RECOMMENDED MOUNTING FOOTPRINT*

*FOR ADDITIONAL INFORMATION ON OUR PB-FREE STRATEGY AND SOLDERING DETAILS, PLEASE DOWNLOAD THE ONSEMI SOLDERING AND MOUNTING TECHNIQUES REFERENCE MANUAL, SOLDERRM/D.

DOCUMENT NUMBER:	98AON10527D	Electronic versions are uncontrolled except when accessed directly from the Document Repository. Printed versions are uncontrolled except when stamped "CONTROLLED COPY" in red.
DESCRIPTION:	DPAK3 6.10x6.54x2.28, 2.29P	PAGE 1 OF 2

onsemi and Onsemi are trademarks of Semiconductor Components Industries, LLC dba onsemi or its subsidiaries in the United States and/or other countries. onsemi reserves the right to make changes without further notice to any products herein. onsemi makes no warranty, representation or guarantee regarding the suitability of its products for any particular purpose, nor does onsemi assume any liability arising out of the application or use of any product or circuit, and specifically disclaims any and all liability, including without limitation special, consequential or incidental damages. onsemi does not convey any license under its patent rights nor the rights of others.

DPAK3 6.10x6.54x2.28, 2.29P
CASE 369C
ISSUE J

DATE 12 AUG 2025

**GENERIC
MARKING DIAGRAM***

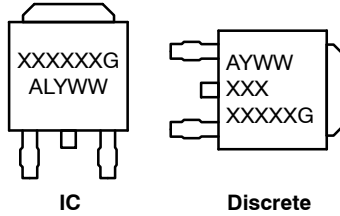

- XXXXXX = Device Code
- A = Assembly Location
- L = Wafer Lot
- Y = Year
- WW = Work Week
- G = Pb-Free Package

*This information is generic. Please refer to device data sheet for actual part marking. Pb-Free indicator, "G" or microdot "▪", may or may not be present. Some products may not follow the Generic Marking.

- | | | | | |
|--|--|---|---|--|
| <p>STYLE 1:
 PIN 1. BASE
 2. COLLECTOR
 3. EMITTER
 4. COLLECTOR</p> | <p>STYLE 2:
 PIN 1. GATE
 2. DRAIN
 3. SOURCE
 4. DRAIN</p> | <p>STYLE 3:
 PIN 1. ANODE
 2. CATHODE
 3. ANODE
 4. CATHODE</p> | <p>STYLE 4:
 PIN 1. CATHODE
 2. ANODE
 3. GATE
 4. ANODE</p> | <p>STYLE 5:
 PIN 1. GATE
 2. ANODE
 3. CATHODE
 4. ANODE</p> |
| <p>STYLE 6:
 PIN 1. MT1
 2. MT2
 3. GATE
 4. MT2</p> | <p>STYLE 7:
 PIN 1. GATE
 2. COLLECTOR
 3. EMITTER
 4. COLLECTOR</p> | <p>STYLE 8:
 PIN 1. N/C
 2. CATHODE
 3. ANODE
 4. CATHODE</p> | <p>STYLE 9:
 PIN 1. ANODE
 2. CATHODE
 3. RESISTOR ADJUST
 4. CATHODE</p> | <p>STYLE 10:
 PIN 1. CATHODE
 2. ANODE
 3. CATHODE
 4. ANODE</p> |

DOCUMENT NUMBER:	98AON10527D	Electronic versions are uncontrolled except when accessed directly from the Document Repository. Printed versions are uncontrolled except when stamped "CONTROLLED COPY" in red.
DESCRIPTION:	DPAK3 6.10x6.54x2.28, 2.29P	PAGE 2 OF 2

onsemi and **Onsemi** are trademarks of Semiconductor Components Industries, LLC dba **onsemi** or its subsidiaries in the United States and/or other countries. **onsemi** reserves the right to make changes without further notice to any products herein. **onsemi** makes no warranty, representation or guarantee regarding the suitability of its products for any particular purpose, nor does **onsemi** assume any liability arising out of the application or use of any product or circuit, and specifically disclaims any and all liability, including without limitation special, consequential or incidental damages. **onsemi** does not convey any license under its patent rights nor the rights of others.

onsemi, **Onsemi**, and other names, marks, and brands are registered and/or common law trademarks of Semiconductor Components Industries, LLC dba "**onsemi**" or its affiliates and/or subsidiaries in the United States and/or other countries. **onsemi** owns the rights to a number of patents, trademarks, copyrights, trade secrets, and other intellectual property. A listing of **onsemi**'s product/patent coverage may be accessed at www.onsemi.com/site/pdf/Patent-Marking.pdf. **onsemi** reserves the right to make changes at any time to any products or information herein, without notice. The information herein is provided "as-is" and **onsemi** makes no warranty, representation or guarantee regarding the accuracy of the information, product features, availability, functionality, or suitability of its products for any particular purpose, nor does **onsemi** assume any liability arising out of the application or use of any product or circuit, and specifically disclaims any and all liability, including without limitation special, consequential or incidental damages. Buyer is responsible for its products and applications using **onsemi** products, including compliance with all laws, regulations and safety requirements or standards, regardless of any support or applications information provided by **onsemi**. "Typical" parameters which may be provided in **onsemi** data sheets and/or specifications can and do vary in different applications and actual performance may vary over time. All operating parameters, including "Typicals" must be validated for each customer application by customer's technical experts. **onsemi** does not convey any license under any of its intellectual property rights nor the rights of others. **onsemi** products are not designed, intended, or authorized for use as a critical component in life support systems or any FDA Class 3 medical devices or medical devices with a same or similar classification in a foreign jurisdiction or any devices intended for implantation in the human body. Should Buyer purchase or use **onsemi** products for any such unintended or unauthorized application, Buyer shall indemnify and hold **onsemi** and its officers, employees, subsidiaries, affiliates, and distributors harmless against all claims, costs, damages, and expenses, and reasonable attorney fees arising out of, directly or indirectly, any claim of personal injury or death associated with such unintended or unauthorized use, even if such claim alleges that **onsemi** was negligent regarding the design or manufacture of the part. **onsemi** is an Equal Opportunity/Affirmative Action Employer. This literature is subject to all applicable copyright laws and is not for resale in any manner.

ADDITIONAL INFORMATION

TECHNICAL PUBLICATIONS:

Technical Library: www.onsemi.com/design/resources/technical-documentation
onsemi Website: www.onsemi.com

ONLINE SUPPORT: www.onsemi.com/support

For additional information, please contact your local Sales Representative at www.onsemi.com/support/sales