

Dual Common-Cathode Zener Diodes

Features

- This diode is also available in other case styles and configurations including: the dual diode common cathode configuration with type designation AZ23, the single diode SOT-23 case with the type designation BZX84C, and the single diode SOD-123 case with the type designation BZT52C.
- Dual Silicon Planar Zener Diodes, Common Cathode
- The Zener voltages are graded according to the international E 24 standard. Standard Zener voltage tolerance is $\pm 5\%$. Replace "C" with "B" for 2% tolerance. Other voltage tolerances and other Zener voltages are available upon request.
- The parameters are valid for both diodes in one case. ΔV_Z and Δr_{zj} of the two diodes in one case is $\leq 5\%$

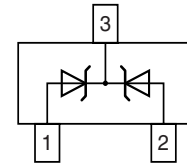
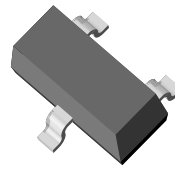

18110

Mechanical Data

Case: SOT-23 Plastic Package

Weight: Approx. 8 mg

Packaging Codes/Options:

E8 / 10k per 13 " reel (8 mm tape), 30k/box

E9 / 3k per 7 " reel (8 mm tape), 30k/box

Absolute Maximum Ratings

$T_{amb} = 25\text{ }^\circ\text{C}$, unless otherwise specified

Parameter	Test condition	Symbol	Value	Unit
Power dissipation		P_{tot}	300 ¹⁾	mW

¹⁾ Device on fiberglass substrate, see layout

Thermal Characteristics

$T_{amb} = 25\text{ }^\circ\text{C}$, unless otherwise specified

Parameter	Test condition	Symbol	Value	Unit
Thermal resistance junction to ambient air		$R_{\theta JA}$	420 ¹⁾	$^\circ\text{C/W}$
Junction temperature		T_j	150	$^\circ\text{C}$
Storage temperature range		T_S	- 65 to + 150	$^\circ\text{C}$

¹⁾ Device on fiberglass substrate, see layout

Electrical Characteristics

Partnumber	Marking Code	Zener Voltage Range ¹⁾		Dynamic Resistance		Test Current	Temperature Coefficient of Zener Voltage		Reverse Voltage
				$r_{zj} @ I_Z = 5 \text{ mA}, f = 1 \text{ kHz},$	$r_{zj} @ I_Z = 1 \text{ mA}, f = 1 \text{ kHz},$		I_Z	$\alpha_{VZ} @ I_Z = 5 \text{ mA}$	
		V		Ω		mA	$10^{-4}/^{\circ}\text{C}$		V
		min	max				min	max	
DZ23-C2V7	V1	2.5	2.9	75 (<83)	<500	5	-9	-4	-
DZ23-C3	V2	2.8	3.2	80 (<95)	<500	5	-9	-3	-
DZ23-C3V3	V3	3.1	3.5	80 (<95)	<500	5	-8	-3	-
DZ23-C3V6	V4	3.4	3.8	80 (<95)	<500	5	-8	-3	-
DZ23-C3V9	V5	3.7	4.1	80 (<95)	<500	5	-7	-3	-
DZ23-C4V3	V6	4	4.6	80 (<95)	<500	5	-6	-1	-
DZ23-C4V7	V7	4.4	5	70 (<78)	<500	5	-5	2	-
DZ23-C5V1	V8	4.8	5.4	30 (<60)	<480	5	-3	4	>0.8
DZ23-C5V6	V9	5.2	6	10 (<40)	<400	5	-2	6	>1
DZ23-C6V2	V10	5.8	6.6	4.8 (<10)	<200	5	-1	7	>2
DZ23-C6V8	V11	6.4	7.2	4.5 (<8)	<150	5	2	7	>3
DZ23-C7V5	V12	7	7.9	4 (<7)	<50	5	-3	7	>5
DZ23-C8V2	V13	7.7	8.7	4.5 (<7)	<50	5	4	7	>6
DZ23-C9V1	V14	8.5	9.6	4.8 (<10)	<50	5	5	8	>7
DZ23-C10	V15	9.4	10.6	5.2 (<15)	<70	5	5	8	>7.5
DZ23-C11	V16	10.4	11.6	6 (<20)	<70	5	5	9	>8.5
DZ23-C12	V17	11.4	12.7	7 (<20)	<90	5	6	9	>9
DZ23-C13	V18	12.4	14.1	9 (<25)	<110	5	7	9	>10
DZ23-C15	V19	13.8	15.6	11 (<30)	<110	5	7	9	>11
DZ23-C16	V20	15.3	17.1	13 (<40)	<170	5	8	9.5	>12
DZ23-C18	V21	16.8	19.1	18 (<50)	<170	5	8	9.5	>14
DZ23-C20	V22	18.8	21.2	20 (<50)	<220	5	8	10	>15
DZ23-C22	V23	20.8	23.3	25 (<55)	<220	5	8	10	>17
DZ23-C24	V24	22.8	25.6	28 (<80)	<220	5	8	10	>18
DZ23-C27	V25	25.1	28.9	30 (<80)	<250	5	8	10	>20
DZ23-C30	V26	28	32	35 (<80)	<250	5	8	10	>22.5
DZ23-C33	V27	31	35	40 (<80)	<250	5	8	10	>25
DZ23-C36	V28	34	38	40 (<90)	<250	5	8	10	>27
DZ23-C39	V29	37	41	50 (<90)	<300	5	10	12	>29
DZ23-C43	V30	40	46	60 (<100)	<700	5	10	12	>32
DZ23-C47	V31	44	50	70 (<100)	<750	5	10	12	>35
DZ23-C51	V32	48	54	70 (<100)	<750	5	10	12	>38

¹⁾ Tested with pulses $t_p = 5 \text{ ms}$



Electrical Characteristics

Partnumber	Marking Code	Zener Voltage Range ¹⁾		Dynamic Resistance		Test Current	Temperature Coefficient of Zener Voltage		Reverse Voltage
				r_{zj} @ $I_Z = 5 \text{ mA}$, $f = 1 \text{ kHz}$,	r_{zj} @ $I_Z = 1 \text{ mA}$, $f = 1 \text{ kHz}$,		I_Z	α_{VZ} @ $I_Z = 5 \text{ mA}$	
		V_Z @ I_Z		Ω		mA	$10^{-4}/^\circ\text{C}$		V
		min	max				min	max	
DZ23-B2V7	V1	2.65	2.75	75 (<83)	<500	5	-9	-4	-
DZ23-B3	V2	2.94	3.06	80 (<95)	<500	5	-9	-3	-
DZ23-B3V3	V3	3.23	3.37	80 (<95)	<500	5	-8	-3	-
DZ23-B3V6	V4	3.53	3.67	80 (<95)	<500	5	-8	-3	-
DZ23-B3V9	V5	3.82	3.98	80 (<95)	<500	5	-7	-3	-
DZ23-B4V3	V6	4.21	4.39	80 (<95)	<500	5	-6	-1	-
DZ23-B4V7	V7	4.61	4.79	70 (<78)	<500	5	-5	2	-
DZ23-B5V1	V8	5	5.2	30 (<60)	<480	5	-3	4	>0.8
DZ23-B5V6	V9	5.49	5.71	10 (<40)	<400	5	-2	6	>1
DZ23-B6V2	V10	6.08	6.32	4.8 (<10)	<200	5	-1	7	>2
DZ23-B6V8	V11	6.66	6.94	4.5 (<8)	<150	5	2	7	>3
DZ23-B7V5	V12	7.35	7.65	4 (<7)	<50	5	-3	7	>5
DZ23-B8V2	V13	8.04	8.36	4.5 (<7)	<50	5	4	7	>6
DZ23-B9V1	V14	8.92	9.28	4.8 (<10)	<50	5	5	8	>7
DZ23-B10	V15	9.8	10.2	5.2 (<15)	<70	5	5	8	>7.5
DZ23-B11	V16	10.8	11.2	6 (<20)	<70	5	5	9	>8.5
DZ23-B12	V17	11.8	12.2	7 (<20)	<90	5	6	9	>9
DZ23-B13	V18	12.7	13.3	9 (<25)	<110	5	7	9	>10
DZ23-B15	V19	14.7	15.3	11 (<30)	<110	5	7	9	>11
DZ23-B16	V20	15.7	16.3	13 (<40)	<170	5	8	0.5	>12
DZ23-B18	V21	17.6	18.4	18 (<50)	<170	5	8	0.5	>14
DZ23-B20	V22	19.6	20.4	20 (<50)	<220	5	8	10	>15
DZ23-B22	V23	21.6	22.4	25 (<55)	<220	5	8	10	>17
DZ23-B24	V24	23.5	24.5	28 (<80)	<220	5	8	10	>18
DZ23-B27	V25	26.5	27.5	30 (<80)	<250	5	8	10	>20
DZ23-B30	V26	29.4	30.6	35 (<80)	<250	5	8	10	>22.5
DZ23-B33	V27	32.3	33.7	40 (<80)	<250	5	8	10	>25
DZ23-B36	V28	35.3	36.7	40 (<90)	<250	5	8	10	>27
DZ23-B39	V29	38.2	39.8	50 (<90)	<300	5	10	12	>29
DZ23-B43	V30	42.1	43.9	60 (<100)	<700	5	10	12	>32
DZ23-B47	V31	46.1	47.9	70 (<100)	<750	5	10	12	>35
DZ23-B51	V32	50	52	70 (<100)	<750	5	10	12	>38

¹⁾ Tested with pulses $t_p = 5 \text{ ms}$

Typical Characteristics ($T_{amb} = 25\text{ }^{\circ}\text{C}$ unless otherwise specified)

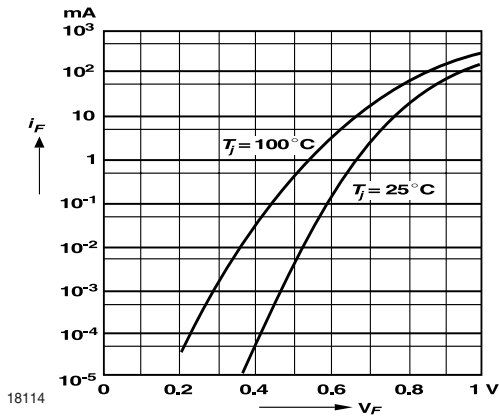

Figure 1. Forward characteristics

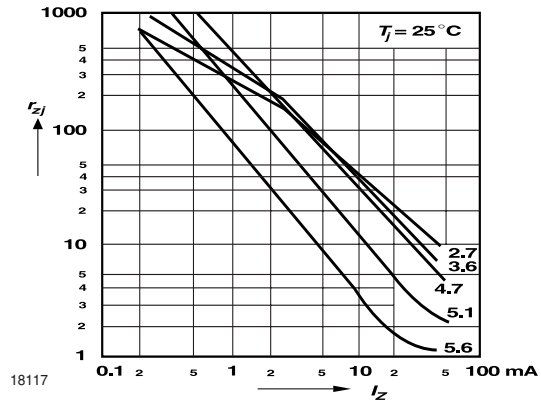

Figure 4. Dynamic Resistance vs. Zener Current

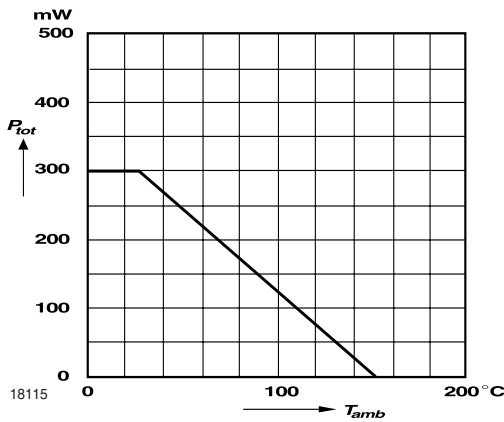

Figure 2. Admissible Power Dissipation vs. Ambient Temperature

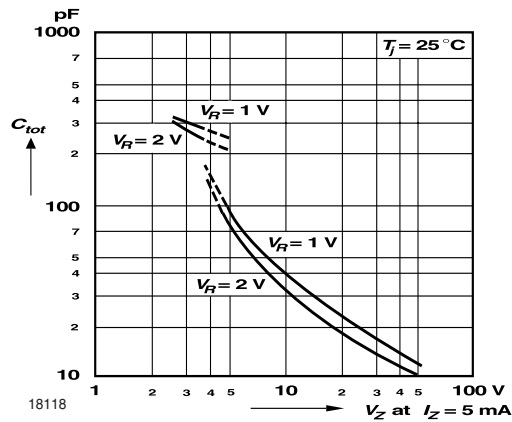

Figure 5. Capacitance vs. Zener Voltage

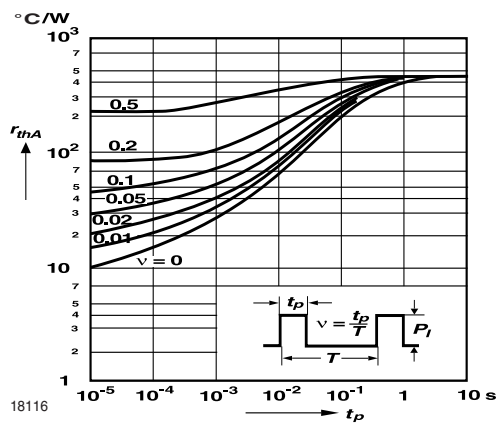

Figure 3. Pulse Thermal Resistance vs. Pulse Duration

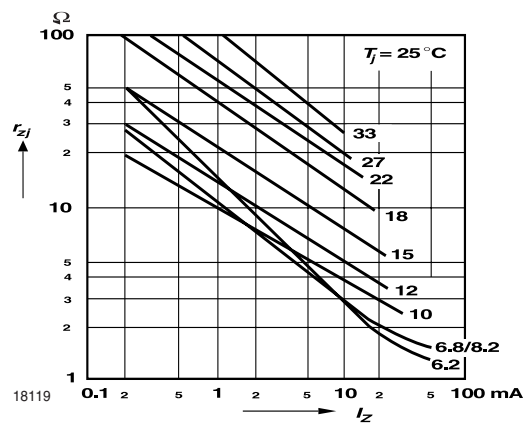

Figure 6. Dynamic Resistance vs. Zener Current

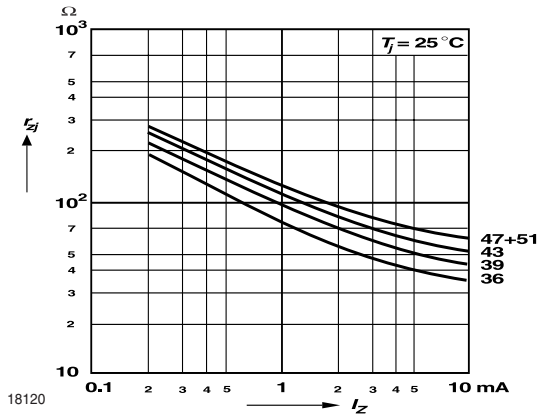

Figure 7. Dynamic Resistance vs. Zener Current

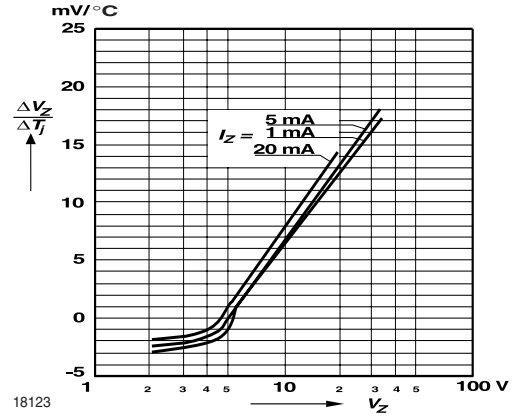

Figure 10. Temperature dependence of Zener voltage versus Zener voltage

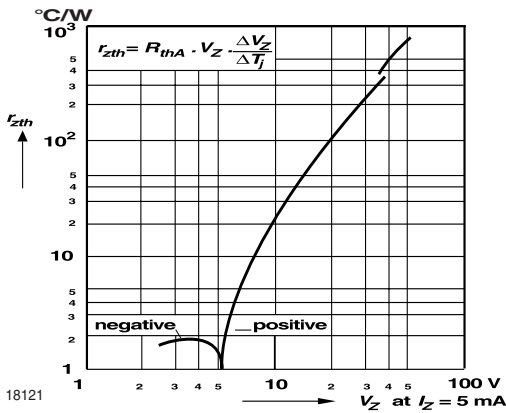

Figure 8. Thermal differential resistance versus Zener voltage

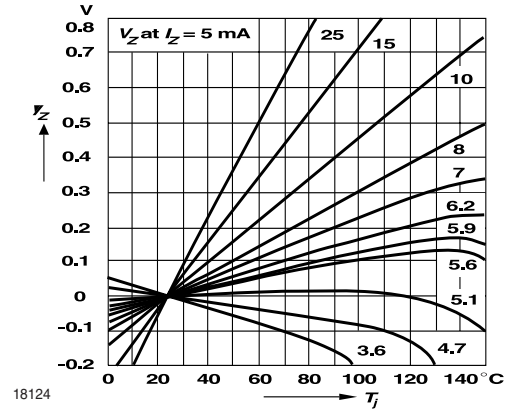

Figure 11. Change of Zener voltage versus junction temperature

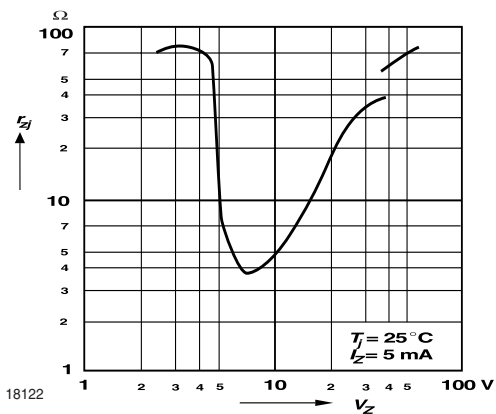

Figure 9. Dynamic resistance versus Zener voltage

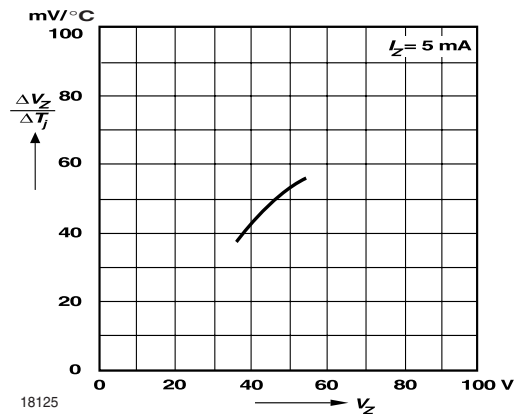

Figure 12. Temperature dependence of Zener voltage versus Zener voltage

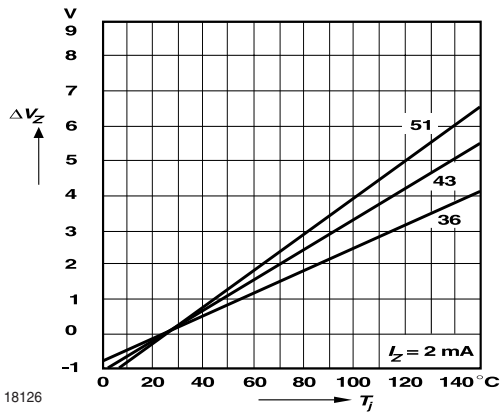

Figure 13. Change of Zener voltage versus junction temperature

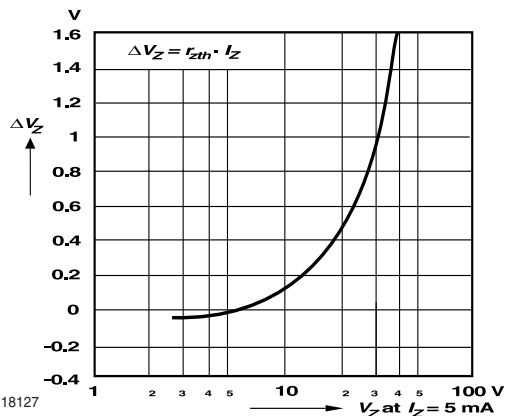

Figure 14. Change of Zener voltage from turn-on up to the point of thermal equilibrium versus Zener voltage

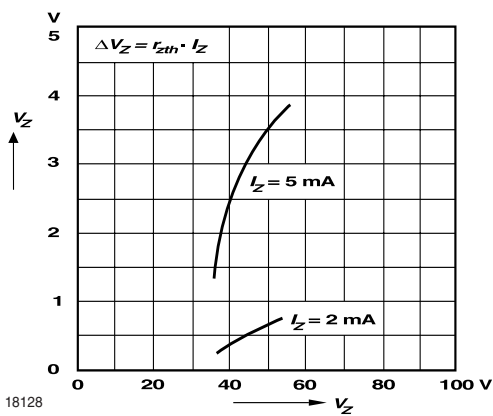

Figure 15. Change of Zener voltage from turn-on up to the point of thermal equilibrium versus Zener voltage

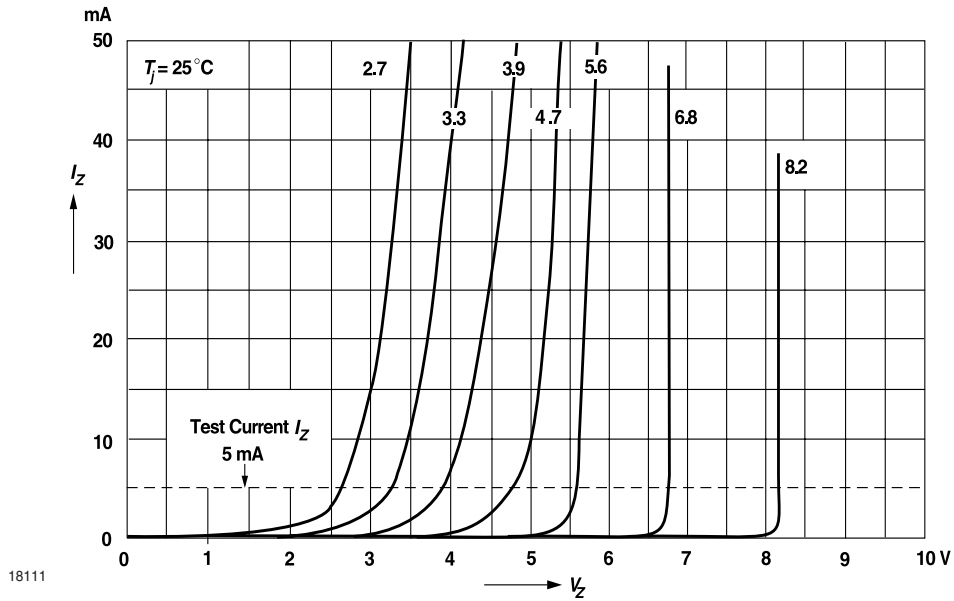

Figure 16. Breakdown Characteristics

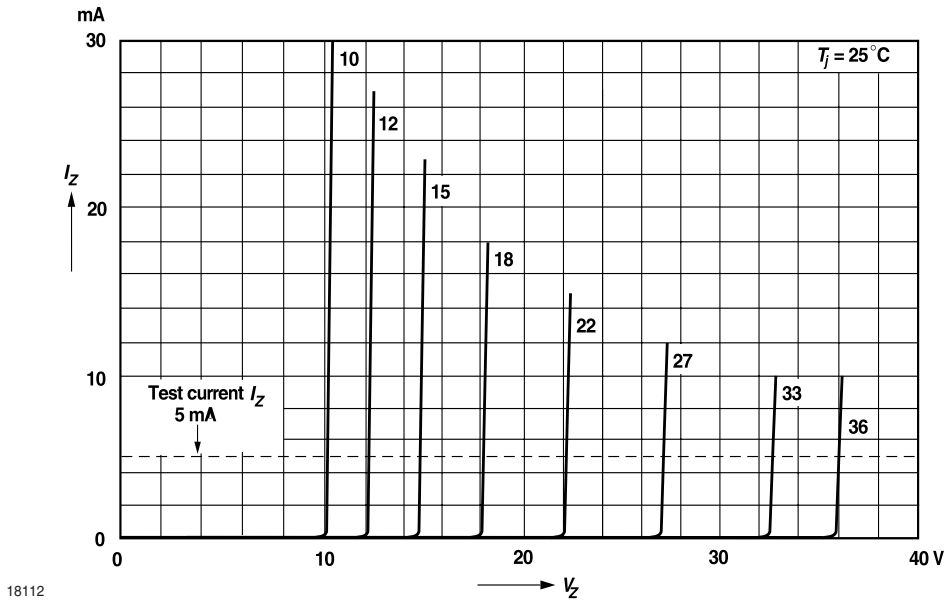
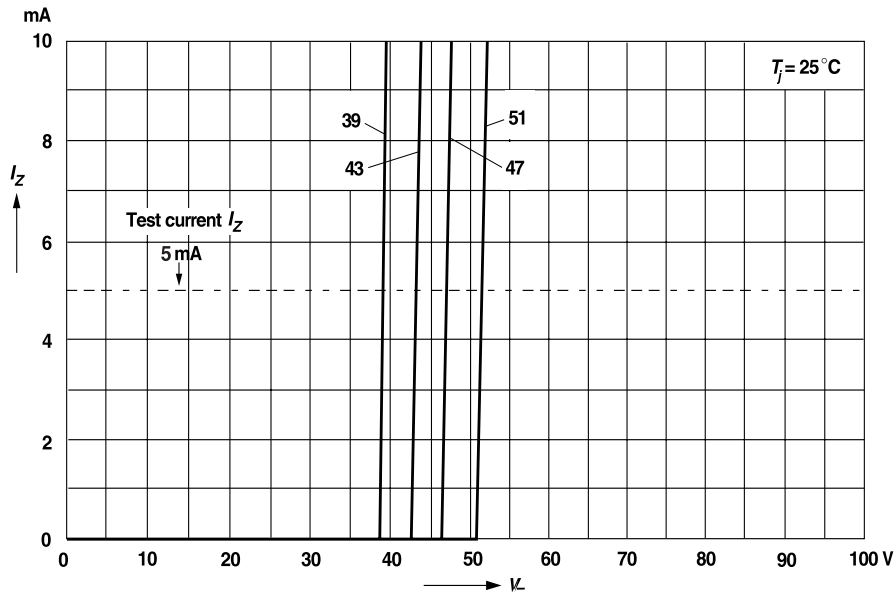

Figure 17. Breakdown Characteristics



18113

Figure 18. Breakdown Characteristics

Layout for $R_{\theta JA}$ test

Thickness: Fiberglass 0.059 in. (1.5 mm)

Copper leads 0.012 in. (0.3 mm)

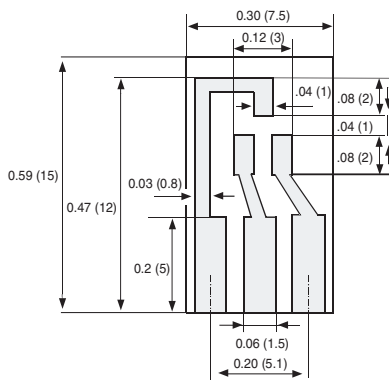

17451

Dimensions in inches (millimeters)

Package Dimensions in Inches (mm)

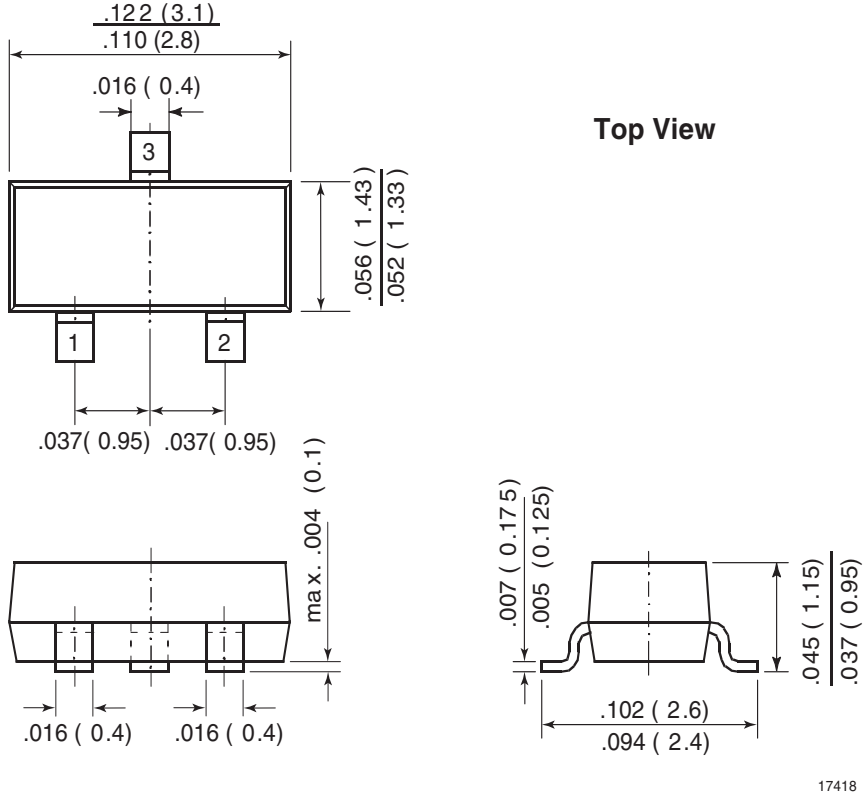

Mounting Pad Layout

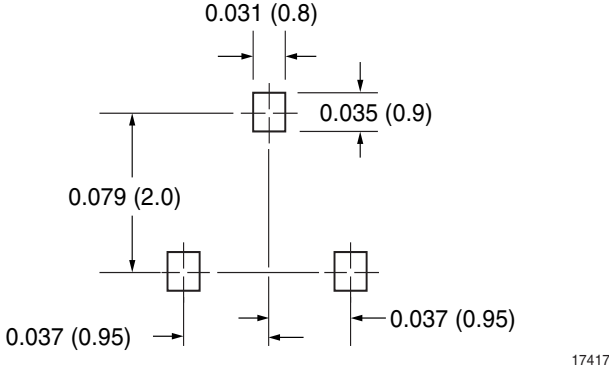

Ozone Depleting Substances Policy Statement

It is the policy of **Vishay Semiconductor GmbH** to

1. Meet all present and future national and international statutory requirements.
2. Regularly and continuously improve the performance of our products, processes, distribution and operating systems with respect to their impact on the health and safety of our employees and the public, as well as their impact on the environment.

It is particular concern to control or eliminate releases of those substances into the atmosphere which are known as ozone depleting substances (ODSs).

The Montreal Protocol (1987) and its London Amendments (1990) intend to severely restrict the use of ODSs and forbid their use within the next ten years. Various national and international initiatives are pressing for an earlier ban on these substances.

Vishay Semiconductor GmbH has been able to use its policy of continuous improvements to eliminate the use of ODSs listed in the following documents.

1. Annex A, B and list of transitional substances of the Montreal Protocol and the London Amendments respectively
2. Class I and II ozone depleting substances in the Clean Air Act Amendments of 1990 by the Environmental Protection Agency (EPA) in the USA
3. Council Decision 88/540/EEC and 91/690/EEC Annex A, B and C (transitional substances) respectively.

Vishay Semiconductor GmbH can certify that our semiconductors are not manufactured with ozone depleting substances and do not contain such substances.

**We reserve the right to make changes to improve technical design
and may do so without further notice.**

Parameters can vary in different applications. All operating parameters must be validated for each customer application by the customer. Should the buyer use Vishay Semiconductors products for any unintended or unauthorized application, the buyer shall indemnify Vishay Semiconductors against all claims, costs, damages, and expenses, arising out of, directly or indirectly, any claim of personal damage, injury or death associated with such unintended or unauthorized use.

Vishay Semiconductor GmbH, P.O.B. 3535, D-74025 Heilbronn, Germany
Telephone: 49 (0)7131 67 2831, Fax number: 49 (0)7131 67 2423