

DRACN Series



- 6.2mm Din-Rail Mount (35 mm) SSR Assembly
- Ratings 24VDC @ 3.5A, 48VDC @ 100mA and 240VAC @ 2A
- 5 & 24 VDC and 120V & 240 VAC Control
- UL & cUL recognized @ 40°C, 100K-Cycle Endurance Test (SSR Only)
- CE & RoHS Compliant
- Yellow LED input status indicator

PRODUCT SELECTION

Description	3.5 A	100 mA	2 A
3-12 VDC	DRA-CN024D05	DRA-CN048D05	DRA-CN240A05
15-30 VDC	DRA-CN024D24	DRA-CN048D24	DRA-CN240A24
90-140 VAC	DRA-CN024D120	DRA-CN048D120	DRA-CN240A120
190-250 VAC	DRA-CN024D240	DRA-CN048D240	DRA-CN240A240

AVAILABLE OPTIONS

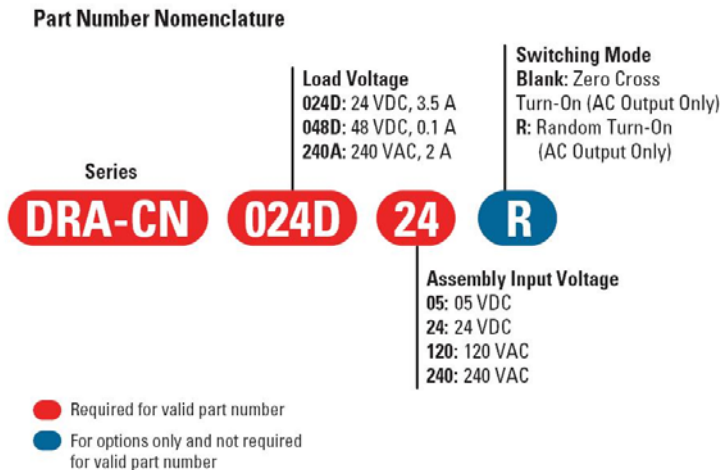

OUTPUT SPECIFICATIONS (1)

Description	DRA-CN024DXX	DRA-CN048DXX	DRA-CN240AXX
Operating Voltage	0-24 VDC	0-48 VDC	24-280 VAC
Maximum Load Current @ 40°C (2)	3.5 A	100 mA	2 A
Minimum Load Current [mA]	1	1	70
Maximum Blocking Voltage	30 VDC	60 VDC	600 VAC
Maximum Surge Current [Apk]	9 A (10 ms)	300 mA (10 ms)	120/115 A (16.6/20 ms)
Maximum I ² t for fusing 50/60Hz (1/2 cycle) [A ² sec]	N.A.	N.A.	285/260
Typical On-State Voltage Drop @ Rated Current (V)	0.4	1.0	1.1
Maximum Off-State Leakage Current @ Rated Voltage [mA]	0.001	0.001	4.0
Maximum PWM (Hz) (3)	500	500	N.A.
Switch Configuration	N.O.	N.O.	N.O.

INPUT SPECIFICATIONS for CN024 (1)

Description	DRA-CN024D05	DRA-CN024D24	DRA-CN024D120	DRA-CN024D240
Control Voltage Range	3-12 VDC	15-30 VDC	90-140 VAC	190-250 VAC
Must Turn On Voltage	3.0 VDC	15 VDC	90 VAC	190 VAC
Must Turn Off Voltage	1.5 VDC	12 VDC	31 VAC	60 VAC
Nominal Input Impedance	500 Ohm	2.67K Ohm	3.5K Ohm	70.6K Ohm
Typical Input Current	10 mA @ 5.0 VDC	9 mA @ 24 VDC	3.4 mA @ 120 VAC	3.4 mA @ 240 VAC
Typical Turn-On Time	120 μ s	350 μ s	2 ms (4)	3 ms (4)
Typical Turn-Off Time	100 μ s	80 μ s	5 ms	6 ms

INPUT SPECIFICATIONS for CN048 (1)

Description	DRA-CN048D05	DRA-CN048D24	DRA-CN048D120	DRA-CN048D240
Control Voltage Range	3-12 VDC	16-30 VDC	100-140 VAC	190-250 VAC
Must Turn On Voltage	3.0 VDC	16 VDC	100 VAC	190 VAC
Must Turn Off Voltage	1.5 VDC	11 VDC	32 VAC	60 VAC
Nominal Input Impedance	833 Ohm	3.43K Ohm	3.5K Ohm	70.6K Ohm
Typical Input Current	6 mA @ 5.0 VDC	7 mA @ 24 VDC	3.4 mA @ 120 VAC	3.4 mA @ 240 VAC
Typical Turn-On Time	20 μ s	20 μ s	1 ms (4)	2 ms (4)
Typical Turn-Off Time	130 μ s	130 μ s	5 ms	6 ms

INPUT SPECIFICATIONS for CN240 (1)

Description	DRA-CN240A05	DRA-CN240A24	DRA-CN240A120	DRA-CN240A240
Control Voltage Range	3-12 VDC	15-30 VDC	90-140 VAC	190-250 VAC
Must Turn On Voltage	3.0 VDC	15 VDC	90 VAC	190 VAC
Must Turn Off Voltage	1.5 VDC	12 VDC	31 VAC	175 VAC
Nominal Input Impedance	333 Ohm	3.43K Ohm	30K Ohm	66.67K Ohm
Typical Input Current	15 mA @ 5.0 VDC	7 mA @ 24 VDC	4 mA @ 120 VAC	3.6 @ 240 VAC
Typical Turn-On Time	1/2 Cycle	1/2 Cycle	1/2 Cycle (5)	1/2 Cycle (5)
Typical Turn-Off Time	1/2 Cycle	1/2 Cycle	1/2 Cycle	1/2 Cycle

GENERAL SPECIFICATIONS

Description	
Dielectric Strength, Input/Output (5)	2.5 KV
Maximum Capacitance, Input/Output	1.5 pF
Ambient Operating Temperature Range	-25 to 60°C
Ambient Storage Temperature Range	-40 to 80°C
Weight (typical)	0.067 lb (31g)
Housing Material	UL 94 V0
Overvoltage Category	III
Polution Degree	2
Degree of protection (SSR Encapsulation)	IP67
Max. Torque (output screws)	5-7 in lb (0.56-0.8 Nm)
Max. Wire Size (load side)	24-14 AWG Solid or Stranded

GENERAL NOTES

- (1) All parameters at 25°C unless otherwise specified.
- (2) See derate curves for more information
- (3) Operating frequency above 500Hz will damage the SSR (DC output only).
- (4) Turn-on time for random turn-on version is 0.1msec
- (5) 3.75KV for CN048Dxx

MECHANICAL SPECIFICATIONS

Tolerances: ± 0.02 in / 0.5 mm
All dimensions are in: inches [millimeters]

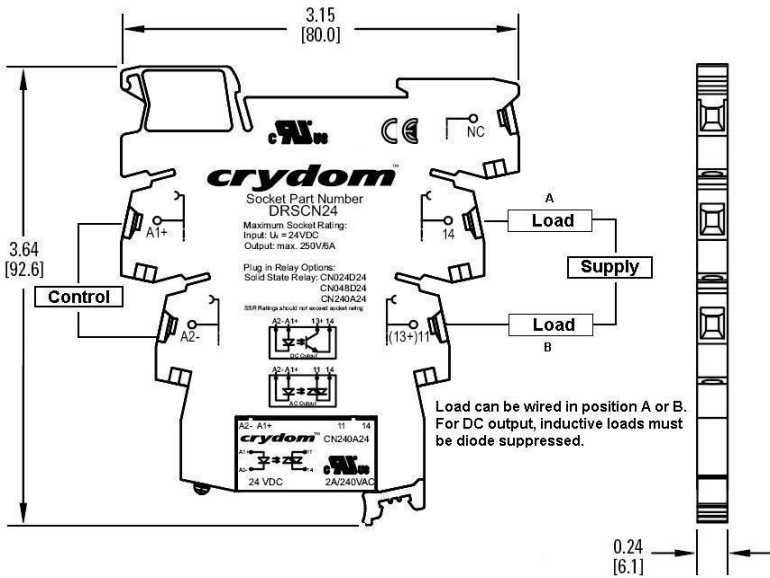

THERMAL DERATE INFORMATION

DERATING CURVE: DRA-CN024DXX

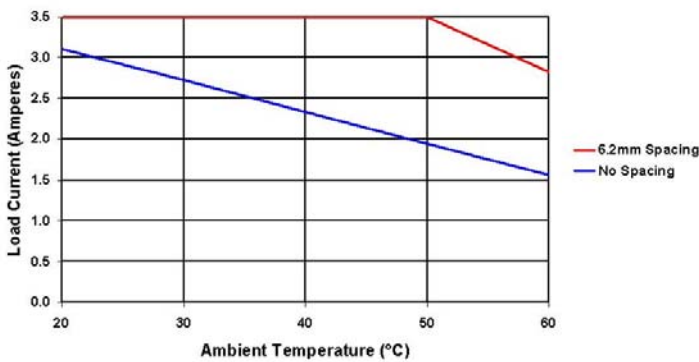

DERATING CURVE: DRA-CN048DXX

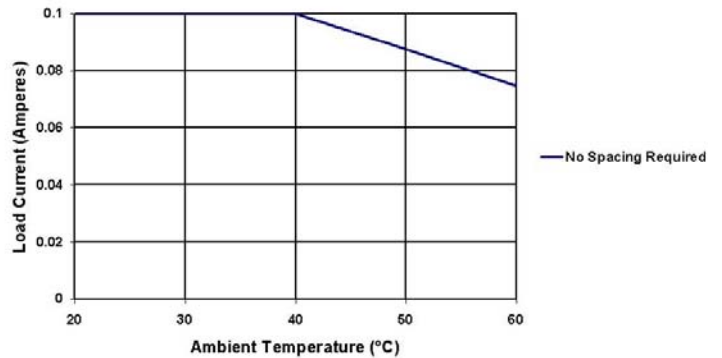

DERATING CURVE: DRA-CN240AXX

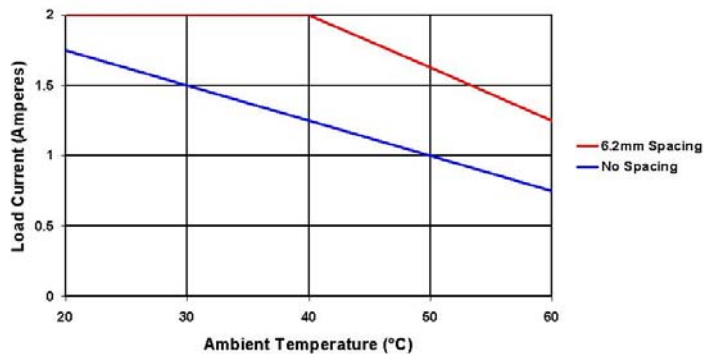

AGENCY APPROVALS



Rev. 022310

ACCESSORIES

ID Marker Strips
CNLB, CNLN, CNL2



Blank Strips

Part no.: CNLB

A package of 10 plastic strips comprising 10 individual unprinted markers which can be placed on sockets' terminal block for easy identification during the use of multiple units.

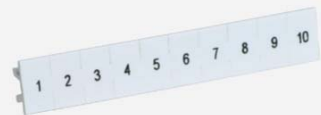

Numbered 1 to 10 Strips

Part no.: CNLN

A package of 10 plastic strips comprising 10 markers printed individually from 1 to 10 which can be placed on sockets' terminal block for easy identification during the use of multiple units.

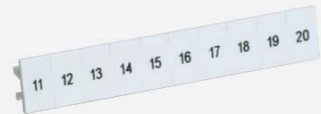

Numbered 11 to 20 Strips

Part no.: CNL2

A package of 10 plastic strips comprising 10 markers printed individually from 11 to 20 which can be placed on sockets' terminal block for easy identification during the use of multiple units.

 DANGER / PELIGRO / DANGER /GEFAHR / PERICOLO / PERIGO					
<p>HAZARD OF ELECTRIC SHOCK, EXPLOSION, OR ARC FLASH.</p> <ul style="list-style-type: none"> • Disconnect all power before installing or working with this equipment. • Verify all connections and replace all covers before turning on power. <p>Failure to follow these instructions will result in death or serious injury.</p>	<p>RIESGO DE DESCARGA ELECTRICA O EXPLOSION.</p> <ul style="list-style-type: none"> • Desconectar todos los suministros de energia a este equipo antes de trabajar con este equipo. • Verificar todas las conexiones y colocar todas las tapas antes de energizar el equipo. <p>EI incumplimiento de estas instrucciones puede provocar la muerte o lesiones serias.</p>	<p>RISQUE DE DESCARGE ELECTRIQUE OU EXPLOSION</p> <ul style="list-style-type: none"> • Eteindre toutes les sources d'énergie de cet appareil avant de travailler dessus de cet appareil • Vérifier tous connections, et remettre tous couverts en olace avant de mettre sous <p>De non-suivi de ces instructions provoquera la mort ou des lésions sérieuses.</p>	<p>GEFAHR EINES ELEKTRISCHEN SCHLAGES ODER EINER EXPLOSION.</p> <ul style="list-style-type: none"> • Stellen Sie jeglichen Strom ab, der dieses Gerät versorgt, bevor Sie an dem Gerät Arbeiten durchführen • Vor der Inbetriebnahme alle Anschlüsse überprüfen und alle Gehäuseteile montieren. <p>Unterlassung dieser Anweisungen können zum Tode oder zu schweren Verletzungen führen.</p>	<p>RISCHIO DI SCOSSA ELETTRICA O DELL'ESPLOSIONE.</p> <ul style="list-style-type: none"> • Spenga tutta l'alimentazione e che fornisce questa apparecchiatura prima del lavorare a questa apparecchiatura • Verificare tutti i collegamenti e sostituire tutte le coperture prima della rotazione sull'alimentazione <p>L'omissione di seguire queste istruzioni provocherà la morte o di lesioni serie</p>	<p>RISCO DE DESCARGA ELÉTRICA OU EXPLOÇÃO</p> <ul style="list-style-type: none"> • Desconectar o equipamento de toda a energia antes de instalar ou trabalhar com este equipamento • Verificar todas as conexões e recolocar todas as tampas antes de religar o equipamento <p>O não cumprimento destas instruções pode levar à morte ou lesões sérias.</p>

 WARNING / AVERTISSEMENT / WARNUNG /ADVERTENCIA / AVVERTENZA / AVISO		
<p>RISK OF MATERIAL DAMAGE AND HOT ENCLOSURE</p> <ul style="list-style-type: none"> • The product's side panels may be hot, allow the product to cool before touching. • Follow proper mounting instructions including torque values. • Do not allow liquids or foreign objects to enter this product. <p>Failure to follow these instructions can result in serious injury, or equipment damage.</p>	<p>RISQUE DE DOMMAGE MATERIEL ET DE SURCHAUFFE DU BOITIER</p> <ul style="list-style-type: none"> • Les panneaux latéraux du produit peuvent être chauds. Laisser le produit refroidir avant de le toucher. • Respecter les consignes de montage, et notamment les couples de serrage. • Ne pas laisser pénétrer de liquide ni de corps étrangers à l'intérieur du produit. <p>Le non-respect de cette directive peut entraîner, des lésions corporelles graves ou des dommages matériels.</p>	<p>GEFAHR VON MATERIALSCHÄDEN UND GEHÄUSEERHITZUNG</p> <ul style="list-style-type: none"> • Die Seitenwände können heiß sein. Lassen Sie das Produkt abkühlen, bevor Sie es berühren. • Beachten Sie die Montageanweisungen, • Führen Sie keine Flüssigkeiten oder Fremdkörper in das Produkt ein. <p>Die Nichtbeachtung dieser Anweisung kann Körperverletzung oder Materialschäden zur Folge haben.</p>
<p>RIESGO DE DAÑOS MATERIALES Y DE SOBRECALENTAMIENTO DE LA UNIDAD</p> <ul style="list-style-type: none"> • Los paneles laterales del producto pueden estar calientes. Esperar que el producto se enfríe antes de tocarlo. • Respetar las instrucciones de montaje, y en particular los pares de apretado. • No dejar que penetren líquidos o cuerpos extraños en el producto. <p>Si no se respetan estas precauciones pueden producirse graves lesiones, daños materiales.</p>	<p>RISCHIO DI DANNI MATERIALI E D'INVOLUCRO CALDO</p> <ul style="list-style-type: none"> • I pannelli laterali dell'apparecchio possono scottare; lasciar quindi raffreddare il prodotto prima di toccarlo. • Seguire le istruzioni di montaggio corrette. • Non far entrare liquidi o oggetti estranei in questo apparecchio. <p>La mancata osservanza di questa precauzione può causare gravi rischi per l'incolumità personale o danni alle apparecchiature.</p>	<p>RISCO DE DANO MATERIAL E DE AQUECIMENTO</p> <ul style="list-style-type: none"> • Os painéis laterais do produto podem estar quentes; dê tempo ao produto para arrefecer antes de lhe tocar. • Siga devidamente as instruções de montagem. • Não permita a entrada de líquidos e de objectos estranhos no produto. <p>A não observância destas precauções pode provocar a morte, ferimentos graves ou danos materiais.</p>

ANNEX - ENVIROMENTAL INFORMATION

The environmental information disclosed in this annex including the EIP Pollution logo are in compliance with People's Republic of China Electronic Industry Standard SJ/T11364 – 2006, Marking for Control of Pollution Caused by Electronic Information Products.

Part Name	Toxic or hazardous Substance and Elements					
	Lead (Pb)	Mercury (Hg)	Cadmium (Cd)	Hexavalent Chromium (Cr (VI))	Polybrominated biphenyls (PBB)	Polybrominated diphenyl ethers (PBDE)
Semiconductor die	X	0	0	0	0	0
Solder	X	0	0	0	0	0

此附件所标示的包括电子信息产品污染图标的环境信息符合中华人民共和国电子行业标准 **SJ/T11364 - 2006**, 电子信息产品污染控制标识要求



部件名称	有毒有害物质或元素					
	铅 (Pb)	汞 (Hg)	镉 (Cd)	六价铬 (Cr (VI))	多溴联苯 (PBB)	多溴二苯醚 (PBDE)
半导体芯片	X	0	0	0	0	0
焊接点	X	0	0	0	0	0