

DO NOT SCALE FROM THIS PRINT

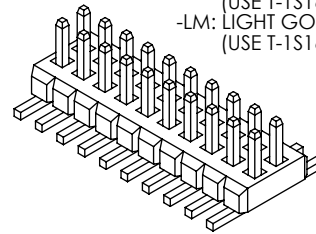
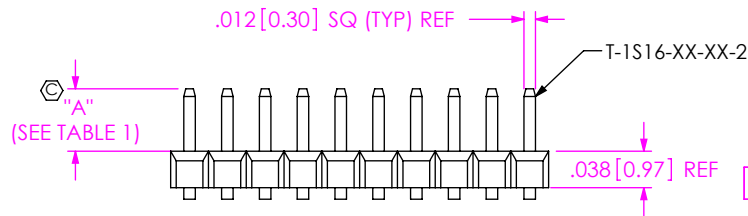
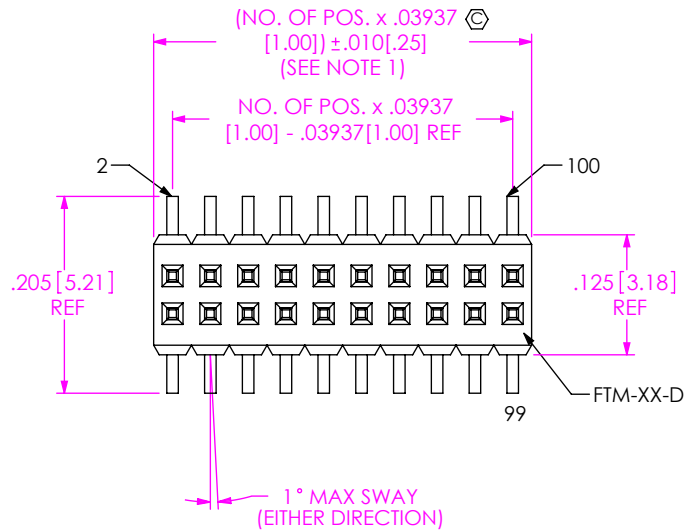

ROW OPTION
-DV: DUAL VERTICAL

NO OF POSITIONS (PER ROW)
-02 THRU -50 (UNSHROUDED)
-05 THRU -46 (SHROUDED)

LEAD STYLE
-02: .075 [1.91] POST HEIGHT
-03: .065 [1.65] POST HEIGHT

PLATING SPECIFICATION
-F: FLASH SELECTIVE (USE T-1S16-XX-F-2)
-L: LIGHT SELECTIVE (USE T-1S16-XX-L-2)
-H: HEAVY GOLD (USE T-1S16-XX-H-2)
-G: GOLD (USE T-1S16-XX-G-2)
-FM: FLASH GOLD W/ MATTE TIN TAILS (USE T-1S16-XX-F-2)
-LM: LIGHT GOLD W/ MATTE TIN TAILS (USE T-1S16-XX-L-2)

PACKAGING
BLANK: TUBES (SEE NOTES 7 & 11)
-TR: TAPE & REEL (SEE NOTES 12 & 13)
-FR: FULL REEL QTY TAPE & REEL (SEE NOTES 12 & 13)

PICK & PLACE OPTION
-P: PICK & PLACE PAD (USE PPP-30) (USE PPP-30-NT FOR TAPE & REEL) (AVAILABLE ON POSITIONS -07 THRU -50) (SEE FIG 4, SHT 3)

OPTION
-S: END SHROUDS (05 POS. MINIMUM) (SEE NOTE 8) (SEE NOTE 9)
PRESS FIT SHROUDS: SEE FIG 2
MOLDED SHROUDS: SEE FIG 6
-SA: END SHROUDS W/ ALIGNMENT PINS (SEE FIG 3, SHT. 2) (SEE NOTE 9) (05 POS PER ROW MINIMUM, 46 POS PER ROW MAXIMUM) (USE FTM-XX-D, USE FTMH-75-D-ES-XX-X FOR MOLDED END SHROUDS)

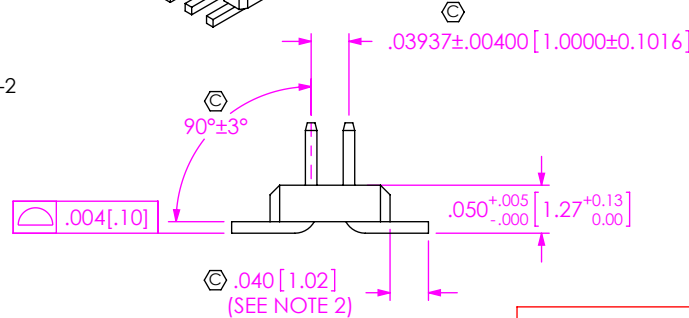

FIG 1
FTM-1XX-02-X-DV SHOWN

PATENT NUMBERS
5655914 / 5785536

NOTES:

1. PARTS MAY BE CUT TO POSITION; .010 MAX CUT FLASH
2. SHEAR TAILS TO DIMENSION SHOWN; .003 MAX BURR.
3. NOTE DELETED.
4. ⊙ REPRESENTS A CRITICAL DIMENSION.
5. NOTE DELETED.
6. NOTE DELETED.
7. POSITIONS -02 THRU -04 TO BE TUBE PACKAGED, AND POSITIONS -05 THRU -50 TO BE TUBE PACKAGED.
8. PARTS WITH -S OPTION ARE TO APPEAR AS SHOWN IN FIG 2 OR FIG 6 AT SAMTEC'S DISCRETION.
9. 4 POSITIONS MUST BE ADDED TO PART CALL OUT TO ALLOW FOR PUSH ON SHROUDS. EX: FTM-125-02-L-DV-S REQUIRES A 29 POSITION STRIP.
10. MINIMUM PUSHOUT FORCE: .5 LB (8 OZ)
11. TUBES ARE STANDARD PACKAGING.
12. ORDERS WILL BE PACKAGED ACCORDING TO THE SAMTEC PACKAGING EFFICIENCY STANDARDS (SPES) FOUND ON WWW.SAMTEC.COM.
13. ATTACH LABEL TO EACH REEL.

TABLE 1		
LEAD STYLE	"A"	TERMINAL
-02	.075 [1.91]	T-1S16-03-XX-2
-03	.065 [1.65]	T-1S16-04-XX-2

CRITICAL DIMENSION INSPECTION INSTRUCTION TABLE	
ASSEMBLY OPERATION	IN PROCESS INSPECTION
AUTO FILL T-1S16-XX-XX-2	C1, C3, C5, C6, C8
HAND FILL	C1, C3
SHEAR	C8
RE-PRESS	C1, C3, C5, C6
CUT TO POSITION	C2, C7
INSTALL FEM	C9, C10, C16
INSTALL FEM-A	C12
INSTALL PICK AND PLACE PAD	C13

CPC'S INTENTIONALLY DELETED: C4, C11, C14, C15

UNLESS OTHERWISE SPECIFIED, DIMENSIONS ARE IN INCHES.
TOLERANCES ARE:
DECIMALS ANGLES
.XX: ±.01 [.3] 3°
.XXX: ±.005 [.13]
.XXXX: ±.0020 [.051]

PROPRIETARY NOTE
THIS DOCUMENT CONTAINS CONFIDENTIAL AND PROPRIETARY INFORMATION AND ALL DESIGN, MANUFACTURING, REPRODUCTION, USE, PATENT RIGHTS AND SALES RIGHTS ARE EXPRESSLY RESERVED BY SAMTEC, INC. THIS DOCUMENT SHALL NOT BE DISCLOSED, IN WHOLE OR PART, TO ANY UNAUTHORIZED PERSON OR ENTITY NOR REPRODUCED, TRANSFERRED OR INCORPORATED IN ANY OTHER PROJECT IN ANY MANNER WITHOUT THE EXPRESS WRITTEN CONSENT OF SAMTEC, INC.

MATERIAL: DO NOT SCALE DRAWING
BODY: VECTRA E130
COLOR: BLACK
TERMINAL: PHOS BRONZE
MAX FLASH ALLOWED: .002 [.05]
MAX GATE VESTIGE ALLOWED: .002 [.05]



520 PARK EAST BLVD, NEW ALBANY, IN 47150
PHONE: 812-944-6733 FAX: 812-948-5047
e-Mail: info@SAMTEC.com code: 55322

DESCRIPTION:
1mm x 1mm LOW PROFILE SMT STRIP ASM
DWG. NO.
FTM-1XX-XX-XX-DV-XX-X-XX
BY: B MENEAR 2/13/2006 SHEET 1 OF 3

FIG 2

-S OPTION
FTM-1XX-02-X-DV-S SHOWN
(DIFFERENT AS SHOWN, OTHERWISE SAME AS FIG 1) (SEE NOTE 8) (SEE NOTE 9)
(PRESS FIT SHROUDS TO HAVE 8 UNUSED SOLDER TAILS AS SHOWN)

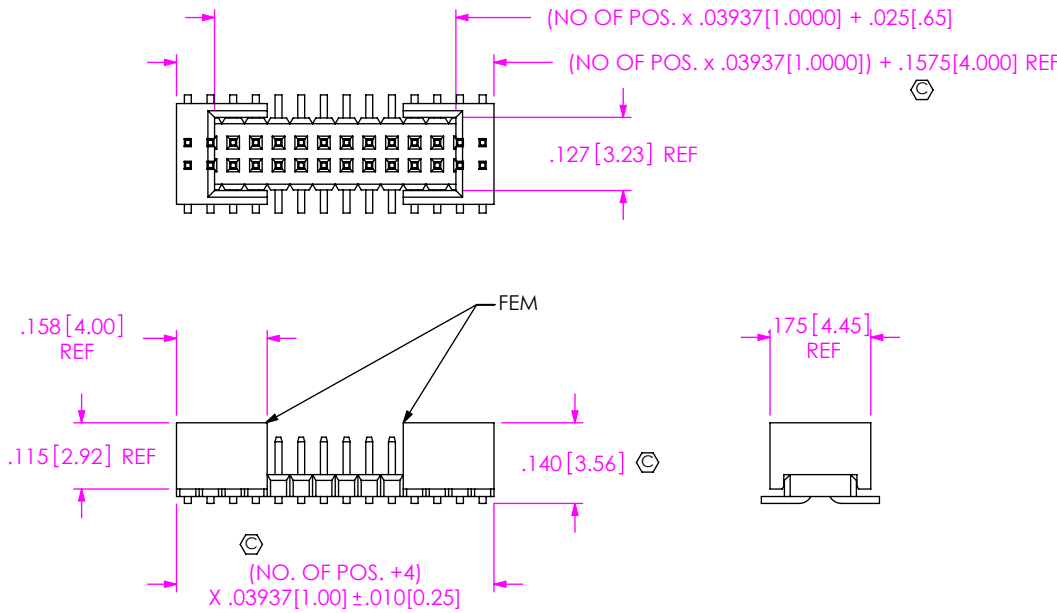

FIG 3

-SA SHOWN: PRESS FIT SHROUD
FTM-1XX-02-X-DV-SA
(DIFFERENT AS SHOWN, OTHERWISE SAME AS FIG 1)
(SEE NOTE 9)

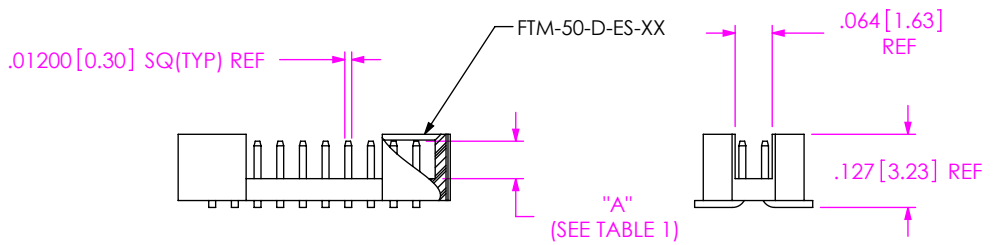
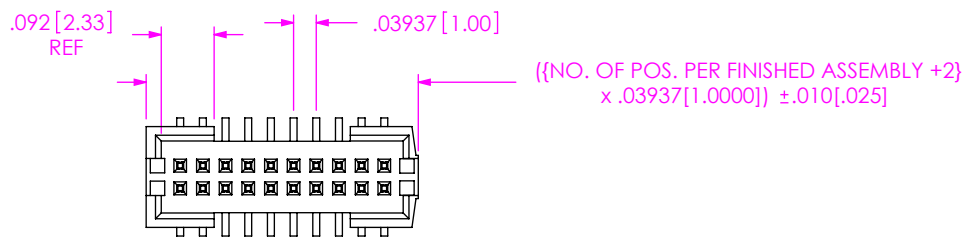
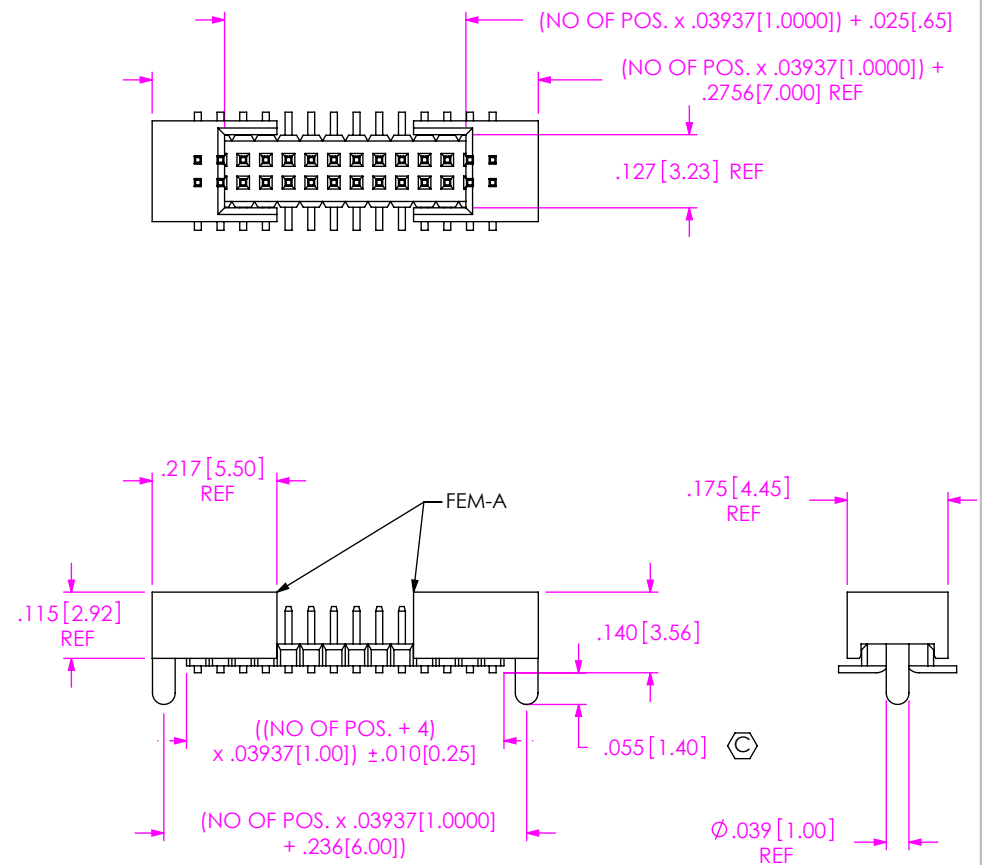

FIG 6

-S OPTION: MOLDED SHROUD
FTM-1XX-02-X-DV-S SHOWN
(DIFFERENT AS SHOWN, OTHERWISE SAME AS FIG 1)(SEE NOTE 8)

PROPRIETARY NOTE
THIS DOCUMENT CONTAINS CONFIDENTIAL AND PROPRIETARY INFORMATION AND ALL DESIGN, MANUFACTURING, REPRODUCTION, USE, PATENT RIGHTS AND SALES RIGHTS ARE EXPRESSLY RESERVED BY SAMTEC, INC. THIS DOCUMENT SHALL NOT BE DISCLOSED, IN WHOLE OR PART, TO ANY UNAUTHORIZED PERSON OR ENTITY NOR REPRODUCED, TRANSFERRED OR INCORPORATED IN ANY OTHER PROJECT IN ANY MANNER WITHOUT THE EXPRESS WRITTEN CONSENT OF SAMTEC, INC.



520 PARK EAST BLVD, NEW ALBANY, IN 47150
PHONE: 812-944-6733 FAX: 812-948-5047
e-Mail: info@SAMTEC.com code: 55322

DO NOT SCALE DRAWING

SHEET SCALE: 2:1

DESCRIPTION:
1mm x 1mm LOW PROFILE SMT STRIP ASM

DWG. NO.
FTM-1XX-XX-XX-DV-XX-X-XX

BY: B MENEAR 2/13/2006 SHEET 2 OF 3

FIG 4

(DIFFERENT AS SHOWN, OTHERWISE SAME AS FIG 1)

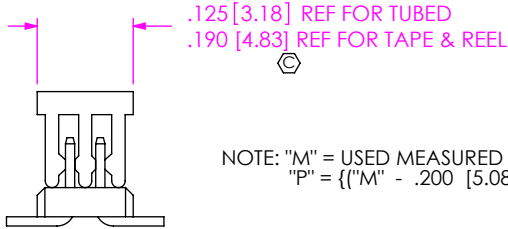
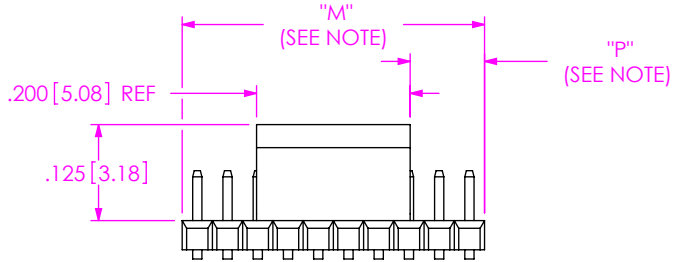

NOTE: "M" = USED MEASURED DIMENSION (REF)
 "P" = {"M" - .200 [5.08]} / 2} +/- .020 [.51]

IN-PROCESS VIEWS ARE FOR HANDFILL ONLY

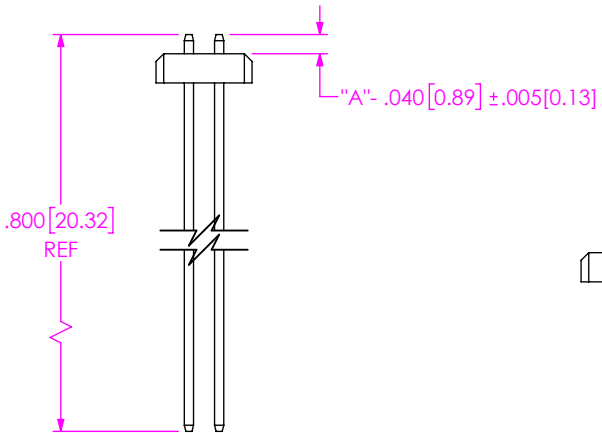

IN-PROCESS 1

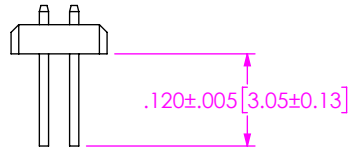

IN-PROCESS 2

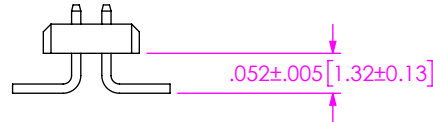

IN-PROCESS 3

PACKAGING VIEW

(SEE NOTE 7)

NOTE:
 ONLY POSITIONS -05 THRU -50 ARE TO BE TUBED. POSITIONS -02 THRU -04 TO BE LAYER PACKAGED ONLY. INSERT PLUG TP-30 AT AN ANGLE INTO PT-1-24-01-49, PLUG MUST SUPPORT THE INSULATOR.

PACKAGING TABLE		
OPTIONS	PACKAGING TUBE	PLUGS
W/O OPTION	PT-1-24-01-49	TP-30
-P	PT-1-24-01-43	TP-24
-S, -S-P, -SA, -SA-P	PT-1-24-13-09	TP-24

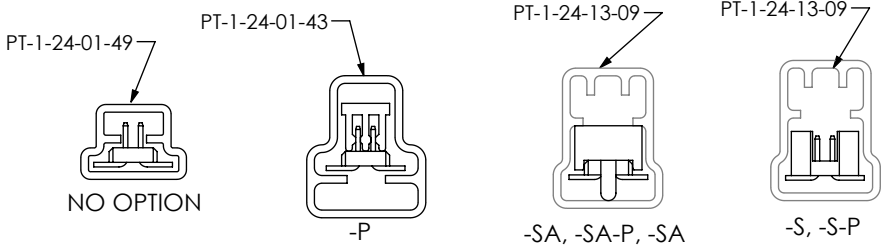

F:\DWG\MISC\MKTG\FTM-1XX-XX-XX-DV-XX-X-XX-MKT.SLDDRW

PROPRIETARY NOTE
 THIS DOCUMENT CONTAINS CONFIDENTIAL AND PROPRIETARY INFORMATION AND ALL DESIGN, MANUFACTURING, REPRODUCTION, USE, PATENT RIGHTS AND SALES RIGHTS ARE EXPRESSLY RESERVED BY SAMTEC, INC. THIS DOCUMENT SHALL NOT BE DISCLOSED, IN WHOLE OR PART, TO ANY UNAUTHORIZED PERSON OR ENTITY NOR REPRODUCED, TRANSFERRED OR INCORPORATED IN ANY OTHER PROJECT IN ANY MANNER WITHOUT THE EXPRESS WRITTEN CONSENT OF SAMTEC, INC.



520 PARK EAST BLVD, NEW ALBANY, IN 47150
 PHONE: 812-944-6733 FAX: 812-948-5047
 e-Mail: info@SAMTEC.com code: 55322

DO NOT SCALE DRAWING

SHEET SCALE: 4:1

DESCRIPTION:
 1mm x 1mm LOW PROFILE SMT STRIP ASM

DWG. NO.
FTM-1XX-XX-XX-DV-XX-X-XX

BY: B MENEAR 2/13/2006 SHEET 3 OF 3