

Cree® XLamp® XM Family LEDs

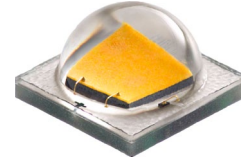
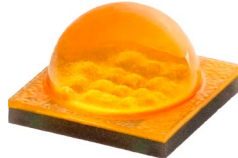
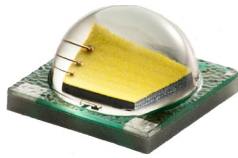

TABLE OF CONTENTS

Introduction	1
Bin and Order Code Formats	2
Performance Groups – Luminous Flux	3
Performance Groups – Chromaticity	4
Performance groups – Voltage	6
Cree’s Standard Chromaticity Regions Plotted on the 1931 CIE Curve	7
Cree’s Standard Cool White Kits Plotted on ANSI Standard Chromaticity Regions	9
Cree’s Standard Warm and Neutral White Kits Plotted on ANSI Standard Chromaticity Regions	10
Cree’s Standard Chromaticity Kits	12
Standard Order Codes and Bins	
XM-L ANSI Cool White	13
XM-L ANSI Neutral White	14
XM-L ANSI Warm White	15
XM-L2 ANSI Cool White	16
XM-L2 ANSI Neutral White	17
XM-L2 ANSI Warm White	18
XM-L High Voltage ANSI Cool White	20
XM-L High Voltage ANSI Neutral White	21
XM-L High Voltage ANSI Warm White	22

INTRODUCTION

This document describes the product nomenclature required to select and order Cree’s XLamp® XM family of LEDs. XLamp XM family LEDs are tested and sorted into bins which are then combined into orderable kits identified by an order code.

All XLamp LEDs are tested and sorted by color and brightness into a unique bin. Each bin contains LEDs from only one color and brightness group and is uniquely identified by a bin code. White XLamp LEDs are sorted by chromaticity (color) and luminous flux (brightness). High Voltage White XLamp LEDs are sorted by chromaticity, luminous flux and voltage. LEDs are shipped on reels containing LEDs from one bin and are always labeled with the appropriate bin code.

Kits contain LEDs from a number of similar bins and are fully defined by their order codes. A full explanation of the order codes for XLamp XM family LEDs, as well as a list of standard order codes, is provided in this document.

BIN AND ORDER CODE FORMATS

Bin codes and order codes for XM-L and XM-L2 White LEDs are configured in the following manner:

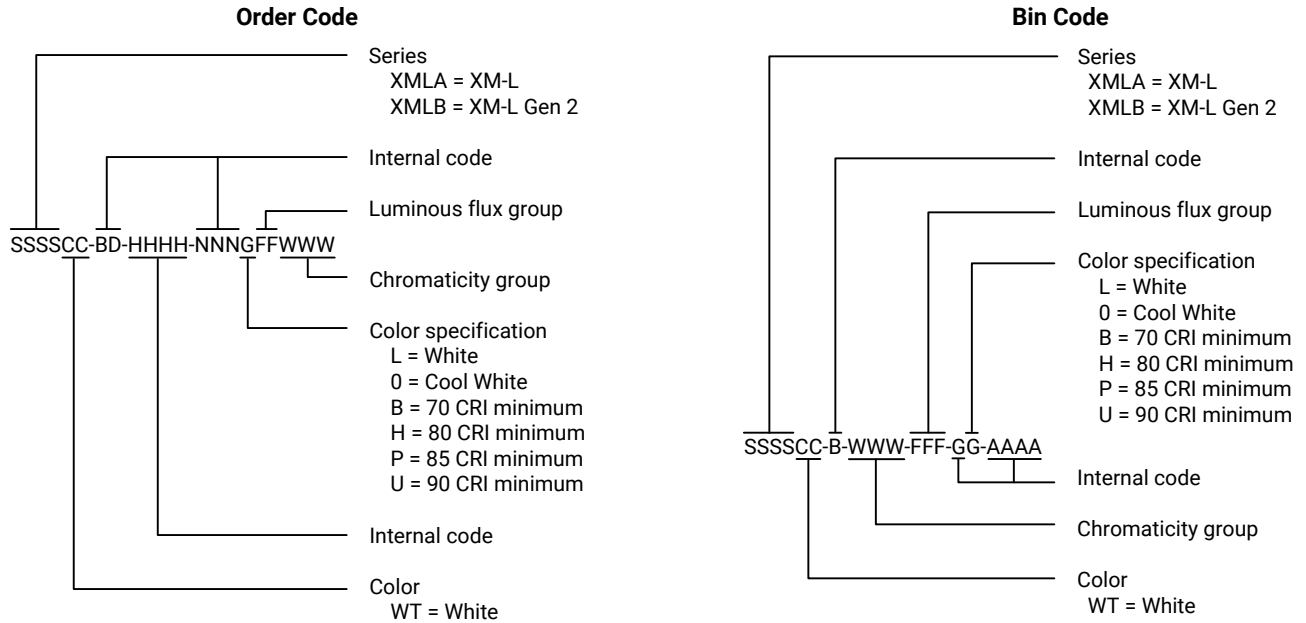

Bin codes and order codes for XM-L High Voltage White LEDs are configured in the following manner:

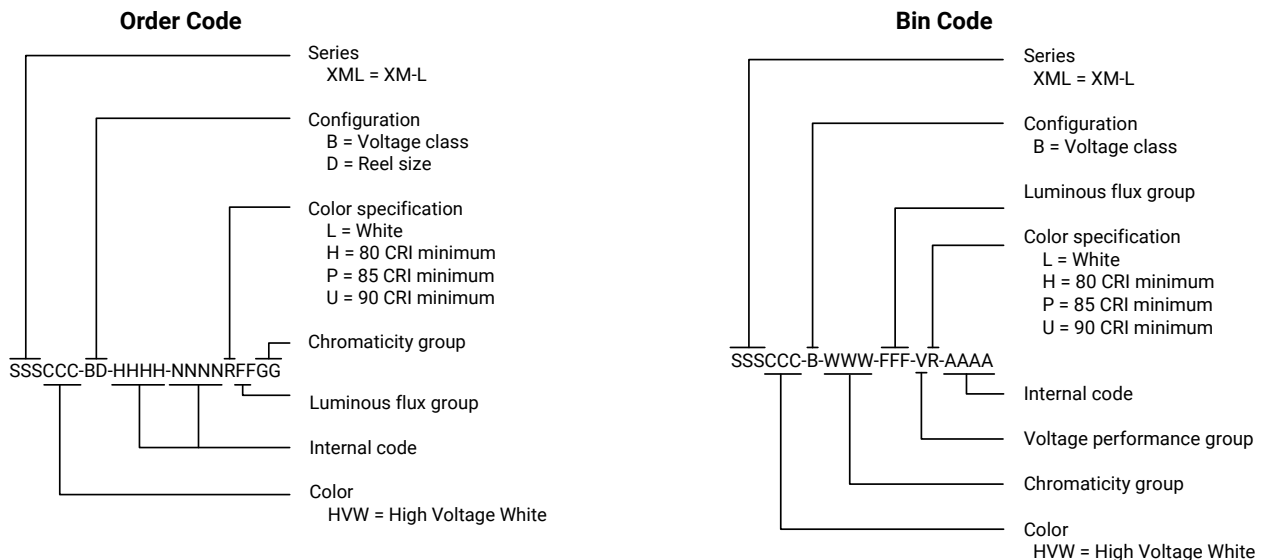

PERFORMANCE GROUPS – LUMINOUS FLUX

XLamp XM-L and XM-L2 White LEDs are tested for luminous flux and placed into one of the following luminous-flux groups:

Group Code	Min. Luminous Flux @ 700 mA (lm)	Max. Luminous Flux @ 700 mA (lm)
S2	148	156
S3	156	164
S4	164	172
S5	172	182
S6	182	200
T2	200	220
T3	220	240
T4	240	260
T5	260	280
T6	280	300
U2	300	320
U3	320	340
U4	340	360

XLamp XM-L High Voltage White LEDs are tested for luminous flux and placed into one of the following luminous-flux groups:

Group Code	Min. Luminous Flux @ 44 mA (lm)	Max. Luminous Flux @ 44 mA (lm)
R5	139	148
S2	148	156
S3	156	164
S4	164	172
S5	172	182
S6	182	200
T2	200	220
T3	220	240
T4	240	260
T5	260	280
T6	280	300

PERFORMANCE GROUPS – CHROMATICITY

Region	x	y	Region	x	y	Region	x	y	Region	x	y
0A	0.2950	0.2970	0B	0.2920	0.3060	0C	0.2984	0.3133	0D	0.2984	0.3133
	0.2920	0.3060		0.2895	0.3135		0.2962	0.3220		0.3048	0.3207
	0.2984	0.3133		0.2962	0.3220		0.3028	0.3304		0.3068	0.3113
	0.3009	0.3042		0.2984	0.3133		0.3048	0.3207		0.3009	0.3042
0R	0.2980	0.2880	0S	0.2895	0.3135	0T	0.2962	0.3220	0U	0.3037	0.2937
	0.2950	0.2970		0.2870	0.3210		0.2937	0.3312		0.3009	0.3042
	0.3009	0.3042		0.2937	0.3312		0.3005	0.3415		0.3068	0.3113
	0.3037	0.2937		0.2962	0.3220		0.3028	0.3304		0.3093	0.2993
1A	0.3048	0.3207	1B	0.3028	0.3304	1C	0.3115	0.3391	1D	0.3130	0.3290
	0.3130	0.3290		0.3115	0.3391		0.3205	0.3481		0.3213	0.3373
	0.3144	0.3186		0.3130	0.3290		0.3213	0.3373		0.3221	0.3261
	0.3068	0.3113		0.3048	0.3207		0.3130	0.3290		0.3144	0.3186
1R	0.3068	0.3113	1S	0.3005	0.3415	1T	0.3099	0.3509	1U	0.3144	0.3186
	0.3144	0.3186		0.3099	0.3509		0.3196	0.3602		0.3221	0.3261
	0.3161	0.3059		0.3115	0.3391		0.3205	0.3481		0.3231	0.3120
	0.3093	0.2993		0.3028	0.3304		0.3115	0.3391		0.3161	0.3059
2A	0.3215	0.3350	2B	0.3207	0.3462	2C	0.3290	0.3538	2D	0.3290	0.3417
	0.3290	0.3417		0.3290	0.3538		0.3376	0.3616		0.3371	0.3490
	0.3290	0.3300		0.3290	0.3417		0.3371	0.3490		0.3366	0.3369
	0.3222	0.3243		0.3215	0.3350		0.3290	0.3417		0.3290	0.3300
2R	0.3222	0.3243	2S	0.3196	0.3602	2T	0.3290	0.3690	2U	0.3290	0.3300
	0.3290	0.3300		0.3290	0.3690		0.3381	0.3762		0.3366	0.3369
	0.3290	0.3180		0.3290	0.3538		0.3376	0.3616		0.3361	0.3245
	0.3231	0.3120		0.3207	0.3462		0.3290	0.3538		0.3290	0.3180
3A	0.3371	0.3490	3B	0.3376	0.3616	3C	0.3463	0.3687	3D	0.3451	0.3554
	0.3451	0.3554		0.3463	0.3687		0.3551	0.3760		0.3533	0.3620
	0.3440	0.3427		0.3451	0.3554		0.3533	0.3620		0.3515	0.3487
	0.3366	0.3369		0.3371	0.3490		0.3451	0.3554		0.3440	0.3427
3R	0.3366	0.3369	3S	0.3381	0.3762	3T	0.3480	0.3840	3U	0.3440	0.3428
	0.3440	0.3428		0.3480	0.3840		0.3571	0.3907		0.3515	0.3487
	0.3429	0.3307		0.3463	0.3687		0.3551	0.3760		0.3495	0.3339
	0.3361	0.3245		0.3376	0.3616		0.3463	0.3687		0.3429	0.3307
4A	0.3530	0.3597	4B	0.3548	0.3736	4C	0.3641	0.3804	4D	0.3615	0.3659
	0.3615	0.3659		0.3641	0.3804		0.3736	0.3874		0.3702	0.3722
	0.3590	0.3521		0.3615	0.3659		0.3702	0.3722		0.3670	0.3578
	0.3512	0.3465		0.3530	0.3597		0.3615	0.3659		0.3590	0.3521
4R	0.3512	0.3465	4S	0.3571	0.3907	4T	0.3668	0.3957	4U	0.3590	0.3521
	0.3590	0.3521		0.3668	0.3957		0.3771	0.4034		0.3670	0.3578
	0.3567	0.3389		0.3641	0.3804		0.3736	0.3874		0.3640	0.3440
	0.3495	0.3339		0.3548	0.3736		0.3641	0.3804		0.3567	0.3389

PERFORMANCE GROUPS – CHROMATICITY (CONTINUED)

Region	x	y	Region	x	y	Region	x	y	Region	x	y
5A1	0.3670	0.3578	5A2	0.3686	0.3649	5A3	0.3744	0.3685	5A4	0.3726	0.3612
	0.3686	0.3649		0.3702	0.3722		0.3763	0.3760		0.3744	0.3685
	0.3744	0.3685		0.3763	0.3760		0.3825	0.3798		0.3804	0.3721
	0.3726	0.3612		0.3744	0.3685		0.3804	0.3721		0.3783	0.3646
5B1	0.3702	0.3722	5B2	0.3719	0.3797	5B3	0.3782	0.3837	5B4	0.3763	0.3760
	0.3719	0.3797		0.3736	0.3874		0.3802	0.3916		0.3782	0.3837
	0.3782	0.3837		0.3802	0.3916		0.3869	0.3958		0.3847	0.3877
	0.3763	0.3760		0.3782	0.3837		0.3847	0.3877		0.3825	0.3798
5C1	0.3825	0.3798	5C2	0.3847	0.3877	5C3	0.3912	0.3917	5C4	0.3887	0.3836
	0.3847	0.3877		0.3869	0.3958		0.3937	0.4001		0.3912	0.3917
	0.3912	0.3917		0.3937	0.4001		0.4006	0.4044		0.3978	0.3958
	0.3887	0.3836		0.3912	0.3917		0.3978	0.3958		0.3950	0.3875
5D1	0.3783	0.3646	5D2	0.3804	0.3721	5D3	0.3863	0.3758	5D4	0.3840	0.3681
	0.3804	0.3721		0.3825	0.3798		0.3887	0.3836		0.3863	0.3758
	0.3863	0.3758		0.3887	0.3836		0.3950	0.3875		0.3924	0.3794
	0.3840	0.3681		0.3863	0.3758		0.3924	0.3794		0.3898	0.3716
6A1	0.3889	0.3690	6A2	0.3915	0.3768	6A3	0.3981	0.3800	6A4	0.3953	0.3720
	0.3915	0.3768		0.3941	0.3848		0.4010	0.3882		0.3981	0.3800
	0.3981	0.3800		0.4010	0.3882		0.4080	0.3916		0.4048	0.3832
	0.3953	0.3720		0.3981	0.3800		0.4048	0.3832		0.4017	0.3751
6B1	0.3941	0.3848	6B2	0.3968	0.3930	6B3	0.4040	0.3966	6B4	0.4010	0.3882
	0.3968	0.3930		0.3996	0.4015		0.4071	0.4052		0.4040	0.3966
	0.4040	0.3966		0.4071	0.4052		0.4146	0.4089		0.4113	0.4001
	0.4010	0.3882		0.4040	0.3966		0.4113	0.4001		0.4080	0.3916
6C1	0.4080	0.3916	6C2	0.4113	0.4001	6C3	0.4186	0.4037	6C4	0.4150	0.3950
	0.4113	0.4001		0.4146	0.4089		0.4222	0.4127		0.4186	0.4037
	0.4186	0.4037		0.4222	0.4127		0.4299	0.4165		0.4259	0.4073
	0.4150	0.3950		0.4186	0.4037		0.4259	0.4073		0.4221	0.3984
6D1	0.4017	0.3751	6D2	0.4048	0.3832	6D3	0.4116	0.3865	6D4	0.4082	0.3782
	0.4048	0.3832		0.4080	0.3916		0.4150	0.3950		0.4116	0.3865
	0.4116	0.3865		0.4150	0.3950		0.4221	0.3984		0.4183	0.3898
	0.4082	0.3782		0.4116	0.3865		0.4183	0.3898		0.4147	0.3814
7A1	0.4147	0.3814	7A2	0.4183	0.3898	7A3	0.4242	0.3919	7A4	0.4203	0.3833
	0.4183	0.3898		0.4221	0.3984		0.4281	0.4006		0.4242	0.3919
	0.4242	0.3919		0.4281	0.4006		0.4342	0.4028		0.4300	0.3939
	0.4203	0.3833		0.4242	0.3919		0.4300	0.3939		0.4259	0.353
7B1	0.4221	0.3984	7B2	0.4259	0.4073	7B3	0.4322	0.4096	7B4	0.4281	0.4006
	0.4259	0.4073		0.4299	0.4165		0.4364	0.4188		0.4322	0.4096
	0.4322	0.4096		0.4364	0.4188		0.4430	0.4212		0.4385	0.4119
	0.4281	0.4006		0.4322	0.4096		0.4385	0.4119		0.4342	0.4028

PERFORMANCE GROUPS – CHROMATICITY (CONTINUED)

Region	x	y	Region	x	y	Region	x	y	Region	x	y
7C1	0.4342	0.4028	7C2	0.4385	0.4119	7C3	0.4449	0.4141	7C4	0.4403	0.4049
	0.4385	0.4119		0.4430	0.4212		0.4496	0.4236		0.4449	0.4141
	0.4449	0.4141		0.4496	0.4236		0.4562	0.4260		0.4513	0.4164
	0.4403	0.4049		0.4449	0.4141		0.4513	0.4164		0.4465	0.4071
7D1	0.4259	0.3853	7D2	0.4300	0.3939	7D3	0.4359	0.3960	7D4	0.4316	0.3873
	0.4300	0.3939		0.4342	0.4028		0.4403	0.4049		0.4359	0.3960
	0.4359	0.3960		0.4403	0.4049		0.4465	0.4071		0.4418	0.3981
	0.4316	0.3873		0.4359	0.3960		0.4418	0.3981		0.4373	0.3893
8A1	0.4373	0.3893	8A2	0.4418	0.3981	8A3	0.4475	0.3994	8A4	0.4428	0.3906
	0.4418	0.3981		0.4465	0.4071		0.4523	0.4085		0.4475	0.3994
	0.4475	0.3994		0.4523	0.4085		0.4582	0.4099		0.4532	0.4008
	0.4428	0.3906		0.4475	0.3994		0.4532	0.4008		0.4483	0.3919
8B1	0.4465	0.4071	8B2	0.4513	0.4164	8B3	0.4573	0.4178	8B4	0.4523	0.4085
	0.4513	0.4164		0.4562	0.4260		0.4624	0.4274		0.4573	0.4178
	0.4573	0.4178		0.4624	0.4274		0.4687	0.4289		0.4634	0.4193
	0.4523	0.4085		0.4573	0.4178		0.4634	0.4193		0.4582	0.4099
8C1	0.4582	0.4099	8C2	0.4634	0.4193	8C3	0.4695	0.4207	8C4	0.4641	0.4112
	0.4634	0.4193		0.4687	0.4289		0.4750	0.4304		0.4695	0.4207
	0.4695	0.4207		0.4750	0.4304		0.4813	0.4319		0.4756	0.4221
	0.4641	0.4112		0.4695	0.4207		0.4756	0.4221		0.4700	0.4126
8D1	0.4483	0.3919	8D2	0.4532	0.4008	8D3	0.4589	0.4021	8D4	0.4538	0.3931
	0.4532	0.4008		0.4582	0.4099		0.4641	0.4112		0.4589	0.4021
	0.4589	0.4021		0.4641	0.4112		0.4700	0.4126		0.4646	0.4034
	0.4538	0.3931		0.4589	0.4021		0.4646	0.4034		0.4593	0.3944

PERFORMANCE GROUPS – VOLTAGE

XLamp XM-L High Voltage White LEDs are classified into one of the following voltage classes:

Forward Voltage Class	Minimum Forward Voltage @ 44 mA (V) T _j = 85 °C	Maximum Forward Voltage @ 44 mA (V) T _j = 85 °C
0	No voltage bin	
1	40.0	42.5
2	42.5	45.0
3	45.0	47.5
4	47.5	50.0
5	50.0	52.5
6	52.5	55.0

CREE'S STANDARD CHROMATICITY REGIONS PLOTTED ON THE 1931 CIE CURVE

ANSI Cool White

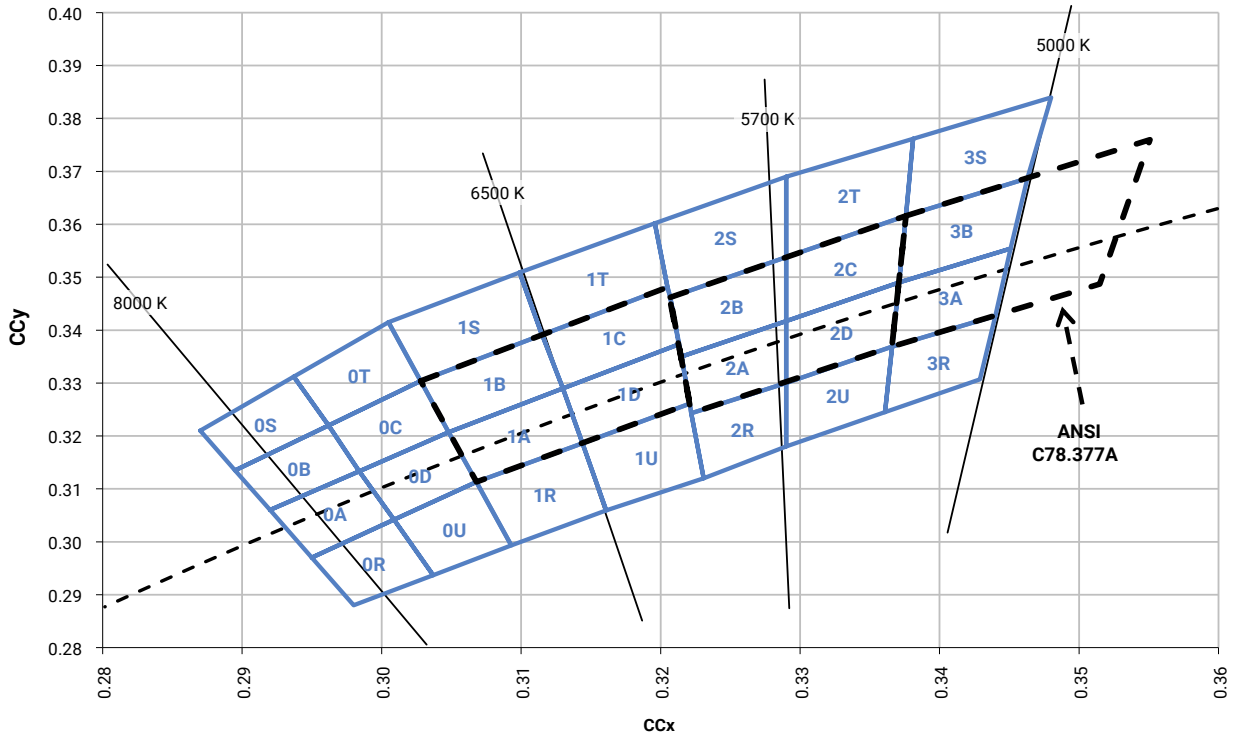

Neutral White

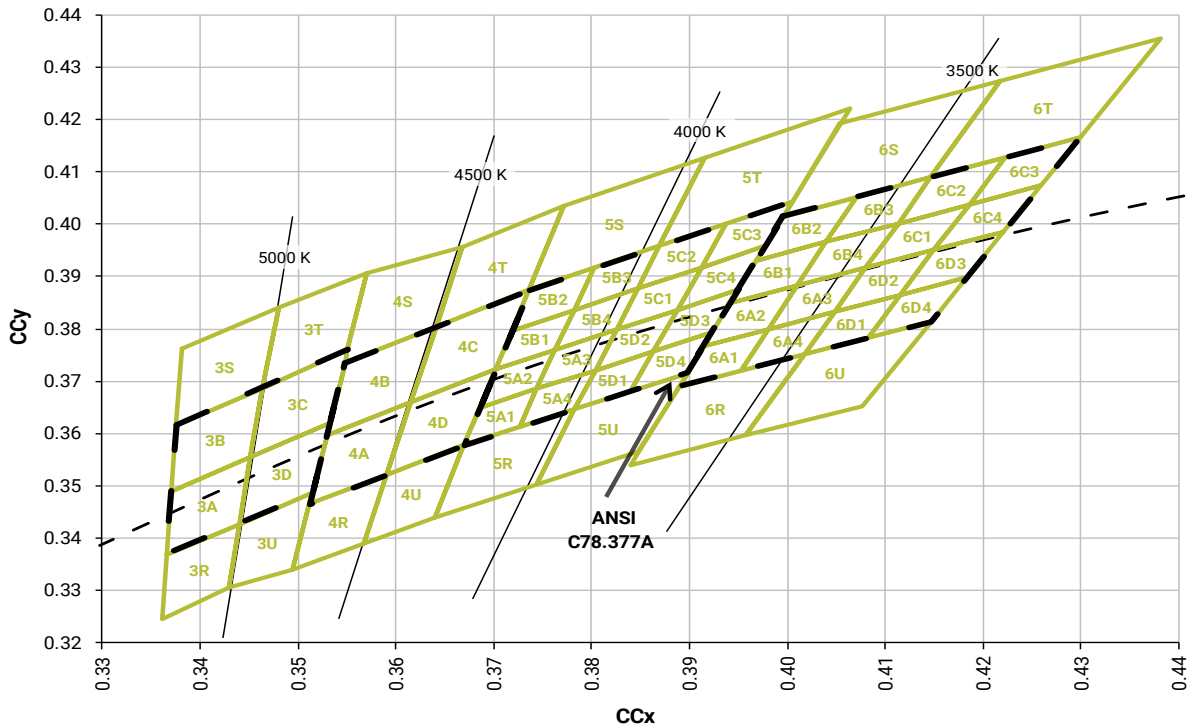

CREE'S STANDARD CHROMATICITY REGIONS PLOTTED ON THE 1931 CIE CURVE - CONTINUED

ANSI Neutral White and ANSI warm white

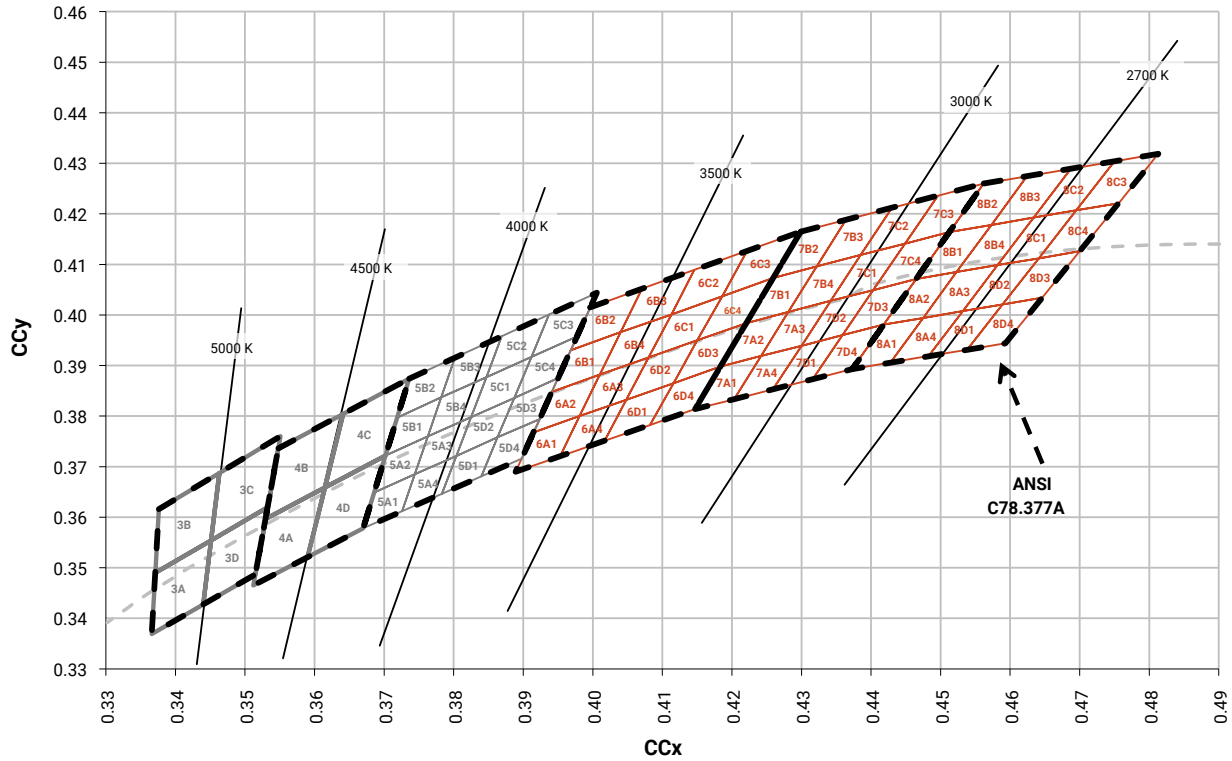

CREE'S STANDARD COOL WHITE KITS PLOTTED ON ANSI STANDARD CHROMATICITY REGIONS

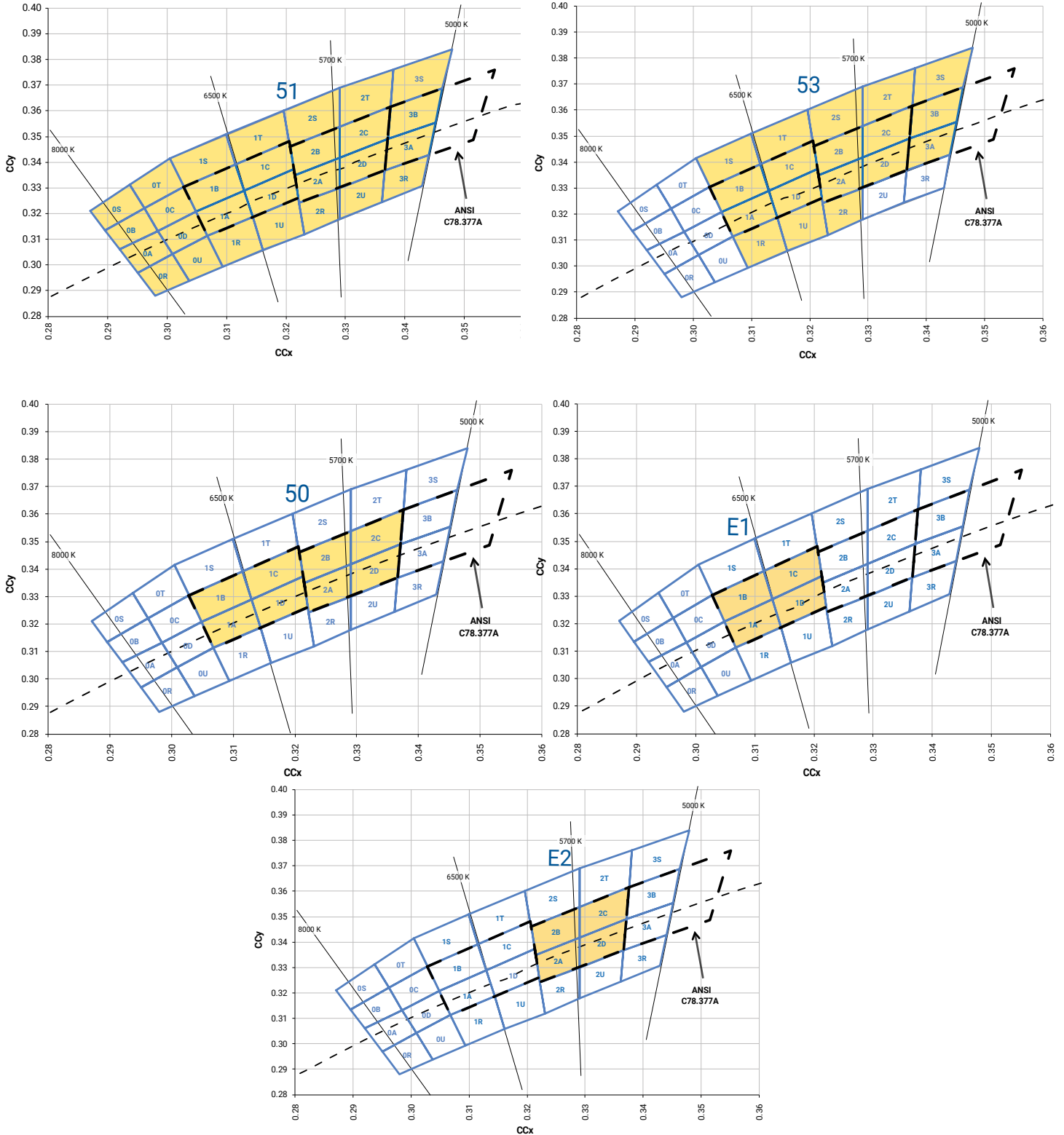

CREE'S STANDARD WARM AND NEUTRAL WHITE KITS PLOTTED ON ANSI STANDARD CHROMATICITY REGIONS

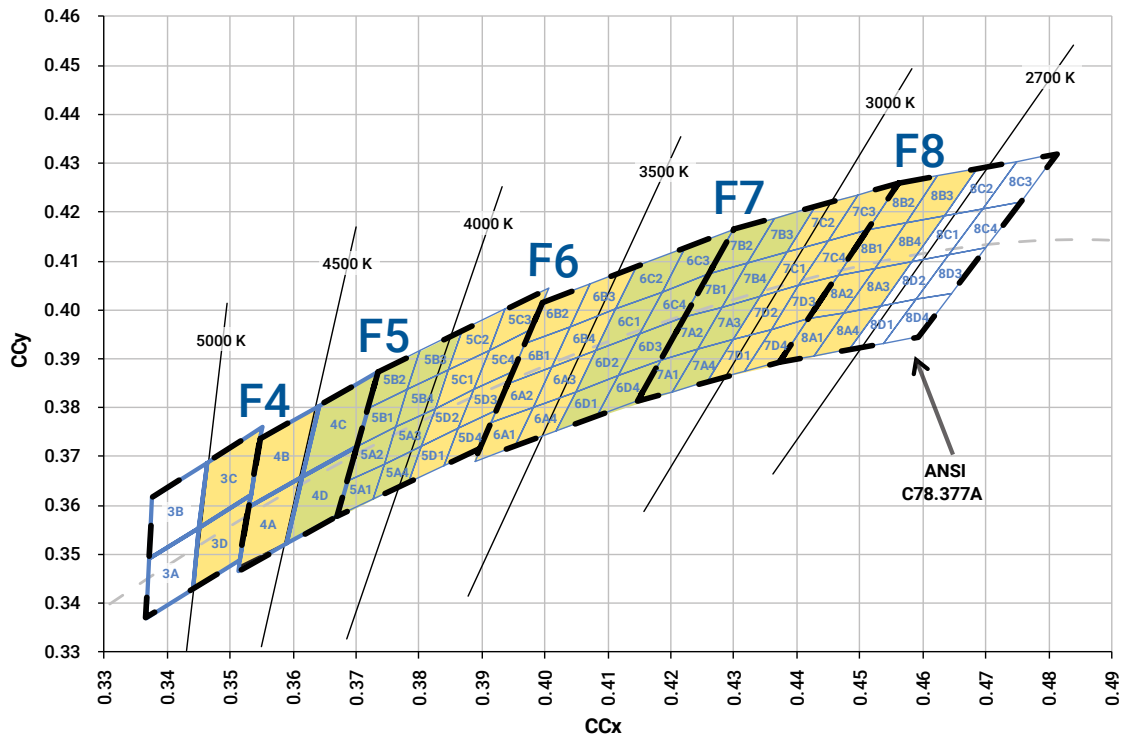
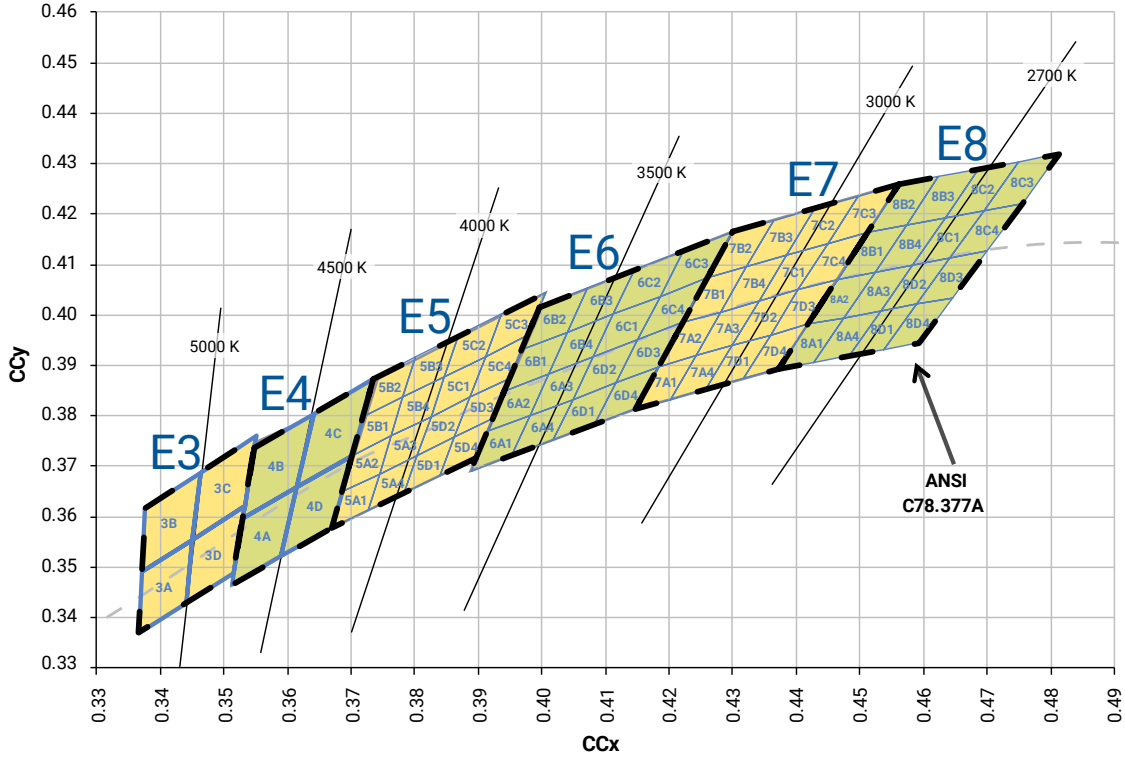

CREE'S STANDARD WARM AND NEUTRAL WHITE KITS PLOTTED ON ANSI STANDARD CHROMATICITY REGIONS - CONTINUED

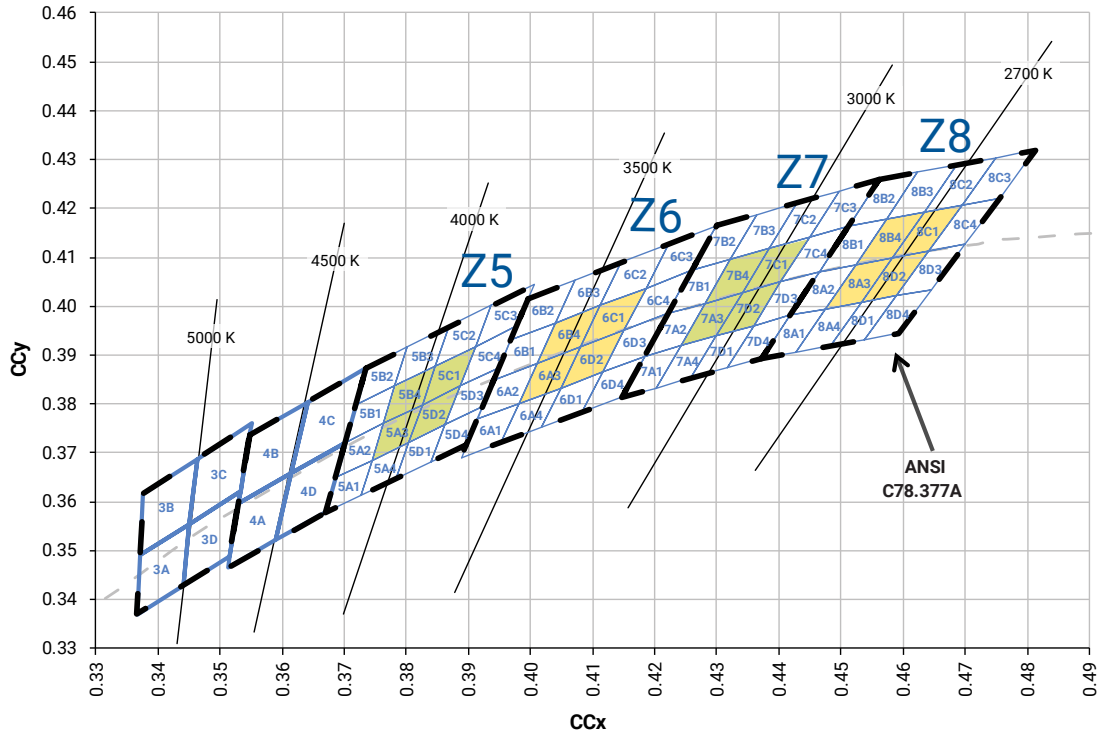

CREE'S STANDARD CHROMATICITY KITS

The following table provides the chromaticity bins associated with chromaticity kits.

Color	CCT	Kit	Chromaticity Bins
Cool White	6200 K	S1	0A, 0B, 0C, 0D, 0R, 0S, 0T, 0U, 1A, 1B, 1C, 1D, 1R, 1S, 1T, 1U, 2A, 2B, 2C, 2D, 2R, 2S, 2T, 2U, 3A, 3B, 3R, 3S
	6000 K	S3	1A, 1B, 1C, 1D, 1R, 1S, 1T, 1U, 2A, 2B, 2C, 2D, 2R, 2S, 2T, 3A, 3B, 3S
	6200 K	S0	1A, 1B, 1C, 1D, 2A, 2B, 2C, 2D
	6500 K	E1	1A, 1B, 1C, 1D
	5700 K	E2	2A, 2B, 2C, 2D
Neutral White	5000 K	E3	3A, 3B, 3C, 3D
	4750 K	F4	3C, 3D, 4A, 4B
	4500 K	E4	4A, 4B, 4C, 4D
	4250 K	F5	4C, 4D, 5A1, 5A2, 5A3, 5A4, 5B1, 5B2, 5B3, 5B4
	4000 K	E5	5A1, 5A2, 5A3, 5A4, 5B1, 5B2, 5B3, 5B4, 5C1, 5C2, 5C3, 5C4, 5D1, 5D2, 5D3, 5D4
	4000 K	Z5	5A3, 5B4, 5C1, 5D2
Warm White	3750 K	F6	5C1, 5C2, 5C3, 5C4, 5D1, 5D2, 5D3, 5D4, 6A1, 6A2, 6A3, 6A4, 6B1, 6B2, 6B3, 6B4
	3500 K	E6	6A1, 6A2, 6A3, 6A4, 6B1, 6B2, 6B3, 6B4, 6C1, 6C2, 6C3, 6C4, 6D1, 6D2, 6D3, 6D4
	3500 K	Z6	6A3, 6B4, 6C1, 6D2
	3250 K	F7	6C1, 6C2, 6C3, 6C4, 6D1, 6D2, 6D3, 6D4, 7A1, 7A2, 7A3, 7A4, 7B1, 7B2, 7B3, 7B4
	3000 K	E7	7A1, 7A2, 7A3, 7A4, 7B1, 7B2, 7B3, 7B4, 7C1, 7C2, 7C3, 7C4, 7D1, 7D2, 7D3, 7D4
	3000 K	Z7	7A3, 7B4, 7C1, 7D2
	2850 K	F8	7C1, 7C2, 7C3, 7C4, 7D1, 7D2, 7D3, 7D4, 8A1, 8A2, 8A3, 8A4, 8B1, 8B2, 8B3, 8B4
	2700 K	E8	8A1, 8A2, 8A3, 8A4, 8B1, 8B2, 8B3, 8B4, 8C1, 8C2, 8C3, 8C4, 8D1, 8D2, 8D3, 8D4
	2700 K	Z8	8A3, 8B4, 8C1, 8D2

* Cree XLamp XM Family LED order codes specify only a minimum flux bin and not a maximum. Cree may ship reels in flux bins higher than the minimum specified by the order code without advance notice. Shipments will always adhere to the chromaticity or DWL bin restrictions specified by the order code.

The following tables of order codes list flux minimums and chromaticity regions for XLamp XM family LEDs. For other flux and chromaticity combinations, contact Cree or an authorized distributor.

STANDARD ORDER CODES AND BINS (XM-L ANSI COOL WHITE, $T_j = 25^\circ\text{C}$)

XLamp XM-L LED Standard Order Codes - White				
Chromaticity		Minimum Luminous Flux (lm) @ 700 mA*		Order Codes
Kit	CCT	Code	Flux (lm)	65 CRI Typical
ANSI Cool White (5000 K – 8300 K)				
51	6200 K	U2	300	XMLAWT-00-0000-0000U2051
		T6	280	XMLAWT-00-0000-0000T6051
		T5	260	XMLAWT-00-0000-0000T5051
53	6000 K	U2	300	XMLAWT-00-0000-0000U2053
		T6	280	XMLAWT-00-0000-0000T6053
		T5	260	XMLAWT-00-0000-0000T5053
50	6200 K	U2	300	XMLAWT-00-0000-0000U2050
		T6	280	XMLAWT-00-0000-0000T6050
		T5	260	XMLAWT-00-0000-0000T5050
E1	6500 K	U2	300	XMLAWT-00-0000-0000U20E1
		T6	280	XMLAWT-00-0000-0000T60E1
		T5	260	XMLAWT-00-0000-0000T50E1
E2	5700 K	U2	300	XMLAWT-00-0000-0000U20E2
		T6	280	XMLAWT-00-0000-0000T60E2
		T5	260	XMLAWT-00-0000-0000T50E2

* Cree XLamp XM Family LED order codes specify only a minimum flux bin and not a maximum. Cree may ship reels in flux bins higher than the minimum specified by the order code without advance notice. Shipments will always adhere to the chromaticity or DWL bin restrictions specified by the order code.

STANDARD ORDER CODES AND BINS (XM-L ANSI NEUTRAL WHITE, $T_j = 25\text{ }^\circ\text{C}$)

XLamp XM-L LED Standard Kit Codes - White					
Chromaticity		Minimum Luminous Flux (lm) @ 700 mA*		Order Codes	
Kit	CCT	Code	Flux (lm)	75 CRI Typical	80 CRI Minimum
ANSI Neutral White (3700 K – 5000 K)					
E3	5000 K	T6	280	XMLAWT-00-0000-000LT60E3	
		T5	260	XMLAWT-00-0000-000LT50E3	
		T4	240	XMLAWT-00-0000-000LT40E3	
F4	4750 K	T5	260	XMLAWT-00-0000-000LT50F4	
		T4	240	XMLAWT-00-0000-000LT40F4	
E4	4500 K	T5	260	XMLAWT-00-0000-000LT50E4	
		T4	240	XMLAWT-00-0000-000LT40E4	
F5	4250 K	T5	260	XMLAWT-00-0000-000LT50F5	
		T4	240	XMLAWT-00-0000-000LT40F5	
E5	4000 K	T5	260	XMLAWT-00-0000-000LT50E5	
		T4	240	XMLAWT-00-0000-000LT40E5	XMLAWT-00-0000-000HT40E5
		T3	220	XMLAWT-00-0000-000LT30E5	XMLAWT-00-0000-000HT30E5
Z5	4000 K	T4	240	XMLAWT-00-0000-000LT40Z5	
		T3	220	XMLAWT-00-0000-000LT30Z5	XMLAWT-00-0000-000HT30Z5

* Cree XLamp XM Family LED order codes specify only a minimum flux bin and not a maximum. Cree may ship reels in flux bins higher than the minimum specified by the order code without advance notice. Shipments will always adhere to the chromaticity or DWL bin restrictions specified by the order code.

STANDARD ORDER CODES AND BINS (XM-L ANSI WARM WHITE, $T_j = 25\text{ }^\circ\text{C}$)

XLamp XM-L LED Standard Kit Codes - White							
Chromaticity		Minimum Luminous Flux (lm) @ 700 mA*		Order Codes			
Kit	CCT	Code	Flux (lm)	80 CRI Typical	80 CRI Minimum	85 CRI Minimum	90 CRI Minimum
ANSI Warm White (2700 K - 3750 K)							
F6	3750 K	T4	240	XMLAWT-00-0000-000LT40F6	XMLAWT-00-0000-000HT40F6		
		T3	220	XMLAWT-00-0000-000LT30F6	XMLAWT-00-0000-000HT30F6		
		T2	200	XMLAWT-00-0000-000LT20F6	XMLAWT-00-0000-000HT20F6		
E6	3500 K	T4	240	XMLAWT-00-0000-000LT40E6	XMLAWT-00-0000-000HT40E6		
		T3	220	XMLAWT-00-0000-000LT30E6	XMLAWT-00-0000-000HT30E6		
		T2	200	XMLAWT-00-0000-000LT20E6	XMLAWT-00-0000-000HT20E6		
Z6	3500 K	T3	220	XMLAWT-00-0000-000LT30Z6	XMLAWT-00-0000-000HT30Z6		
		T2	200	XMLAWT-00-0000-000LT20Z6	XMLAWT-00-0000-000HT20Z6		
F7	3250 K	T3	220	XMLAWT-00-0000-000LT30F7	XMLAWT-00-0000-000HT30F7		
		T2	200	XMLAWT-00-0000-000LT20F7	XMLAWT-00-0000-000HT20F7		
E7	3000 K	T3	220	XMLAWT-00-0000-000LT30E7	XMLAWT-00-0000-000HT30E7		
		T2	200	XMLAWT-00-0000-000LT20E7	XMLAWT-00-0000-000HT20E7		
		S6	182			XMLAWT-00-0000-000PS60E7	XMLAWT-00-0000-000US60E7
		S5	172			XMLAWT-00-0000-000PS50E7	XMLAWT-00-0000-000US50E7
		S4	164			XMLAWT-00-0000-000PS40E7	XMLAWT-00-0000-000US40E7
Z7	3000 K	T3	220	XMLAWT-00-0000-000LT30Z7	XMLAWT-00-0000-000HT30Z7		
		T2	200	XMLAWT-00-0000-000LT20Z7	XMLAWT-00-0000-000HT20Z7		
		S6	182				
		S5	172			XMLAWT-00-0000-000PS50Z7	XMLAWT-00-0000-000US50Z7
		S4	164			XMLAWT-00-0000-000PS40Z7	XMLAWT-00-0000-000US40Z7
F8	2850 K	T2	200	XMLAWT-00-0000-000LT20F8	XMLAWT-00-0000-000HT20F8		
		S6	182	XMLAWT-00-0000-000LS60F8	XMLAWT-00-0000-000HS60F8		
		S5	172			XMLAWT-00-0000-000PS50F8	XMLAWT-00-0000-000US50F8
		S4	164			XMLAWT-00-0000-000PS40F8	XMLAWT-00-0000-000US40F8
		S3	156			XMLAWT-00-0000-000PS30F8	XMLAWT-00-0000-000US30F8
E8	2700 K	T2	200	XMLAWT-00-0000-000LT20E8	XMLAWT-00-0000-000HT20E8		
		S6	182	XMLAWT-00-0000-000LS60E8	XMLAWT-00-0000-000HS60E8		
		S5	172			XMLAWT-00-0000-000PS50E8	XMLAWT-00-0000-000US50E8
		S4	164			XMLAWT-00-0000-000PS40E8	XMLAWT-00-0000-000US40E8
		S3	156			XMLAWT-00-0000-000PS30E8	XMLAWT-00-0000-000US30E8
Z8	2700 K	T2	200	XMLAWT-00-0000-000LT20Z8	XMLAWT-00-0000-000HT20Z8		
		S6	182	XMLAWT-00-0000-000LS60Z8	XMLAWT-00-0000-000HS60Z8		
		S5	172				
		S4	164			XMLAWT-00-0000-000PS40Z8	XMLAWT-00-0000-000US40Z8
		S3	156			XMLAWT-00-0000-000PS30Z8	XMLAWT-00-0000-000US30Z8

* Cree XLamp XM Family LED order codes specify only a minimum flux bin and not a maximum. Cree may ship reels in flux bins higher than the minimum specified by the order code without advance notice. Shipments will always adhere to the chromaticity or DWL bin restrictions specified by the order code.

STANDARD ORDER CODES AND BINS (XM-L2 ANSI COOL WHITE, $T_j = 85\text{ }^\circ\text{C}$)

XLamp XM-L2 LED Standard Order Codes - White					
Chromaticity		Minimum Luminous Flux (lm) @ 700 mA*		Order Codes	
Kit	CCT	Code	Flux (lm)	65 CRI Typical	85 CRI Minimum
ANSI Cool White (5000 K – 8300 K)					
51	6200 K	U3	320	XMLBWT-00-0000-0000U3051	
		U2	300	XMLBWT-00-0000-0000U2051	
		T6	280	XMLBWT-00-0000-0000T6051	
		T5	260	XMLBWT-00-0000-0000T5051	
		T4	240		XMLBWT-00-0000-000PT4051
		T3	220		XMLBWT-00-0000-000PT3051
		T2	200		XMLBWT-00-0000-000PT2051
53	6000 K	U3	320	XMLBWT-00-0000-0000U3053	
		U2	300	XMLBWT-00-0000-0000U2053	
		T6	280	XMLBWT-00-0000-0000T6053	
		T5	260	XMLBWT-00-0000-0000T5053	
		T4	240		XMLBWT-00-0000-000PT4053
		T3	220		XMLBWT-00-0000-000PT3053
		T2	200		XMLBWT-00-0000-000PT2053
50	6200 K	U3	320	XMLBWT-00-0000-0000U3050	
		U2	300	XMLBWT-00-0000-0000U2050	
		T6	280	XMLBWT-00-0000-0000T6050	
		T5	260	XMLBWT-00-0000-0000T5050	
		T4	240		XMLBWT-00-0000-000PT4050
		T3	220		XMLBWT-00-0000-000PT3050
		T2	200		XMLBWT-00-0000-000PT2050
E1	6500 K	U3	320	XMLBWT-00-0000-0000U30E1	
		U2	300	XMLBWT-00-0000-0000U20E1	
		T6	280	XMLBWT-00-0000-0000T60E1	
		T5	260	XMLBWT-00-0000-0000T50E1	
		T4	240		XMLBWT-00-0000-000PT40E1
		T3	220		XMLBWT-00-0000-000PT30E1
		T2	200		XMLBWT-00-0000-000PT20E1
E2	5700 K	U3	320	XMLBWT-00-0000-0000U30E2	
		U2	300	XMLBWT-00-0000-0000U20E2	
		T6	280	XMLBWT-00-0000-0000T60E2	
		T5	260	XMLBWT-00-0000-0000T50E2	
		T4	240		XMLBWT-00-0000-000PT40E2
		T3	220		XMLBWT-00-0000-000PT30E2
		T2	200		XMLBWT-00-0000-000PT20E2

* Cree XLamp XM Family LED order codes specify only a minimum flux bin and not a maximum. Cree may ship reels in flux bins higher than the minimum specified by the order code without advance notice. Shipments will always adhere to the chromaticity or DWL bin restrictions specified by the order code.

STANDARD ORDER CODES AND BINS (XM-L2 ANSI NEUTRAL WHITE, $T_j = 85\text{ °C}$)

XLamp XM-L2 LED Standard Kit Codes - White						
Chromaticity		Minimum Luminous Flux (lm) @ 700 mA*		Order Codes		
Kit	CCT	Code	Flux (lm)	70 CRI Minimum	75 CRI Typical	80 CRI Minimum
ANSI Neutral White (3700 K – 5000 K)						
E3	5000 K	U3	320	XMLBWT-00-0000-000BU30E3		
		U2	300	XMLBWT-00-0000-000BU20E3	XMLBWT-00-0000-000LU20E3	
		T6	280	XMLBWT-00-0000-000BT60E3	XMLBWT-00-0000-000LT60E3	
		T5	260	XMLBWT-00-0000-000BT50E3	XMLBWT-00-0000-000LT50E3	
		T4	240		XMLBWT-00-0000-000LT40E3	
F4	4750 K	U3	320	XMLBWT-00-0000-000BU30F4		
		U2	300	XMLBWT-00-0000-000BU20F4	XMLBWT-00-0000-000LU20F4	
		T6	280	XMLBWT-00-0000-000BT60F4	XMLBWT-00-0000-000LT60F4	
		T5	260	XMLBWT-00-0000-000BT50F4	XMLBWT-00-0000-000LT50F4	
		T4	240		XMLBWT-00-0000-000LT40F4	
E4	4500 K	U3	320	XMLBWT-00-0000-000BU30E4		
		U2	300	XMLBWT-00-0000-000BU20E4	XMLBWT-00-0000-000LU20E4	
		T6	280	XMLBWT-00-0000-000BT60E4	XMLBWT-00-0000-000LT60E4	
		T5	260	XMLBWT-00-0000-000BT50E4	XMLBWT-00-0000-000LT50E4	
		T4	240		XMLBWT-00-0000-000LT40E4	
F5	4250 K	U2	300	XMLBWT-00-0000-000BU20F5		
		T6	280	XMLBWT-00-0000-000BT60F5	XMLBWT-00-0000-000LT60F5	
		T5	260	XMLBWT-00-0000-000BT50F5	XMLBWT-00-0000-000LT50F5	
		T4	240	XMLBWT-00-0000-000BT40F5	XMLBWT-00-0000-000LT40F5	
E5	4000 K	U2	300	XMLBWT-00-0000-000BU20E5		
		T6	280	XMLBWT-00-0000-000BT60E5	XMLBWT-00-0000-000LT60E5	XMLBWT-00-0000-000HT60E5
		T5	260	XMLBWT-00-0000-000BT50E5	XMLBWT-00-0000-000LT50E5	XMLBWT-00-0000-000HT50E5
		T4	240	XMLBWT-00-0000-000BT40E5	XMLBWT-00-0000-000LT40E5	XMLBWT-00-0000-000HT40E5
		T3	220		XMLBWT-00-0000-000LT30E5	XMLBWT-00-0000-000HT30E5
Z5	4000 K	T5	260		XMLBWT-00-0000-000LT50Z5	XMLBWT-00-0000-000HT50Z5
		T4	240		XMLBWT-00-0000-000LT40Z5	XMLBWT-00-0000-000HT40Z5
		T3	220		XMLBWT-00-0000-000LT30Z5	XMLBWT-00-0000-000HT30Z5

* Cree XLamp XM Family LED order codes specify only a minimum flux bin and not a maximum. Cree may ship reels in flux bins higher than the minimum specified by the order code without advance notice. Shipments will always adhere to the chromaticity or DWL bin restrictions specified by the order code.

STANDARD ORDER CODES AND BINS (XM-L2 ANSI WARM WHITE, $T_j = 85^\circ\text{C}$)

XLamp XM-L2 LED Standard Kit Codes - White							
Chromaticity		Minimum Luminous Flux (lm) @ 700 mA*		Order Codes			
Kit	CCT	Code	Flux (lm)	80 CRI Typical	80 CRI Minimum	85 CRI Minimum	90 CRI Minimum
ANSI Warm White (2700 K - 3750 K)							
F6	3750 K	T6	280	XMLBWT-00-0000-000LT60F6	XMLBWT-00-0000-000HT60F6		
		T5	260	XMLBWT-00-0000-000LT50F6	XMLBWT-00-0000-000HT50F6		
		T4	240	XMLBWT-00-0000-000LT40F6	XMLBWT-00-0000-000HT40F6		
		T3	220	XMLBWT-00-0000-000LT30F6	XMLBWT-00-0000-000HT30F6		
		T2	200	XMLBWT-00-0000-000LT20F6	XMLBWT-00-0000-000HT20F6		
E6	3500 K	T6	280	XMLBWT-00-0000-000LT60E6	XMLBWT-00-0000-000HT60E6		
		T5	260	XMLBWT-00-0000-000LT50E6	XMLBWT-00-0000-000HT50E6		
		T4	240	XMLBWT-00-0000-000LT40E6	XMLBWT-00-0000-000HT40E6		
		T3	220	XMLBWT-00-0000-000LT30E6	XMLBWT-00-0000-000HT30E6		
		T2	200	XMLBWT-00-0000-000LT20E6	XMLBWT-00-0000-000HT20E6		
Z6	3500 K	T5	260	XMLBWT-00-0000-000LT50Z6	XMLBWT-00-0000-000HT50Z6		
		T4	240	XMLBWT-00-0000-000LT40Z6	XMLBWT-00-0000-000HT40Z6		
		T3	220	XMLBWT-00-0000-000LT30Z6	XMLBWT-00-0000-000HT30Z6		
		T2	200	XMLBWT-00-0000-000LT20Z6	XMLBWT-00-0000-000HT20Z6		
F7	3250 K	T5	260	XMLBWT-00-0000-000LT50F7	XMLBWT-00-0000-000HT50F7		
		T4	240	XMLBWT-00-0000-000LT40F7	XMLBWT-00-0000-000HT40F7		
		T3	220	XMLBWT-00-0000-000LT30F7	XMLBWT-00-0000-000HT30F7		
		T2	200	XMLBWT-00-0000-000LT20F7	XMLBWT-00-0000-000HT20F7		
E7	3000 K	T5	260	XMLBWT-00-0000-000LT50E7	XMLBWT-00-0000-000HT50E7		
		T4	240	XMLBWT-00-0000-000LT40E7	XMLBWT-00-0000-000HT40E7		
		T3	220	XMLBWT-00-0000-000LT30E7	XMLBWT-00-0000-000HT30E7		
		T2	200	XMLBWT-00-0000-000LT20E7	XMLBWT-00-0000-000HT20E7	XMLBWT-00-0000-000PT20E7	XMLBWT-00-0000-000UT20E7
		S6	182			XMLBWT-00-0000-000PS60E7	XMLBWT-00-0000-000US60E7
		S5	172			XMLBWT-00-0000-000PS50E7	XMLBWT-00-0000-000US50E7
Z7	3000 K	T4	240	XMLBWT-00-0000-000LT40Z7	XMLBWT-00-0000-000HT40Z7		
		T3	220	XMLBWT-00-0000-000LT30Z7	XMLBWT-00-0000-000HT30Z7		
		T2	200	XMLBWT-00-0000-000LT20Z7	XMLBWT-00-0000-000HT20Z7		
		S6	182			XMLBWT-00-0000-000PS60Z7	XMLBWT-00-0000-000US60Z7
		S5	172			XMLBWT-00-0000-000PS50Z7	XMLBWT-00-0000-000US50Z7
		S4	164			XMLBWT-00-0000-000PS40Z7	XMLBWT-00-0000-000US40Z7

* Cree XLamp XM Family LED order codes specify only a minimum flux bin and not a maximum. Cree may ship reels in flux bins higher than the minimum specified by the order code without advance notice. Shipments will always adhere to the chromaticity or DWL bin restrictions specified by the order code.

STANDARD ORDER CODES AND BINS (XM-L2 ANSI WARM WHITE, $T_j = 85^\circ\text{C}$) - CONTINUED

XLamp XM-L2 LED Standard Kit Codes - White							
Chromaticity		Minimum Luminous Flux (lm) @ 700 mA*		Order Codes			
Kit	CCT	Code	Flux (lm)	80 CRI Typical	80 CRI Minimum	85 CRI Minimum	90 CRI Minimum
ANSI Warm White (2700 K - 3750 K)							
F8	2850 K	T5	260	XMLBWT-00-0000-000LT50F8	XMLBWT-00-0000-000HT50F8		
		T4	240	XMLBWT-00-0000-000LT40F8	XMLBWT-00-0000-000HT40F8		
		T3	220	XMLBWT-00-0000-000LT30F8	XMLBWT-00-0000-000HT30F8		
		T2	200	XMLBWT-00-0000-000LT20F8	XMLBWT-00-0000-000HT20F8		
		S6	182	XMLBWT-00-0000-000LS60F8	XMLBWT-00-0000-000HS60F8	XMLBWT-00-0000-000PS60F8	XMLBWT-00-0000-000US60F8
		S5	172			XMLBWT-00-0000-000PS50F8	XMLBWT-00-0000-000US50F8
		S4	164			XMLBWT-00-0000-000PS40F8	XMLBWT-00-0000-000US40F8
		S3	156			XMLBWT-00-0000-000PS30F8	XMLBWT-00-0000-000US30F8
E8	2700 K	T5	260	XMLBWT-00-0000-000LT50E8	XMLBWT-00-0000-000HT50E8		
		T4	240	XMLBWT-00-0000-000LT40E8	XMLBWT-00-0000-000HT40E8		
		T3	220	XMLBWT-00-0000-000LT30E8	XMLBWT-00-0000-000HT30E8		
		T2	200	XMLBWT-00-0000-000LT20E8	XMLBWT-00-0000-000HT20E8		
		S6	182	XMLBWT-00-0000-000LS60E8	XMLBWT-00-0000-000HS60E8	XMLBWT-00-0000-000PS60E8	XMLBWT-00-0000-000US60E8
		S5	172			XMLBWT-00-0000-000PS50E8	XMLBWT-00-0000-000US50E8
		S4	164			XMLBWT-00-0000-000PS40E8	XMLBWT-00-0000-000US40E8
		S3	156			XMLBWT-00-0000-000PS30E8	XMLBWT-00-0000-000US30E8
Z8	2700 K	T4	240	XMLBWT-00-0000-000LT40Z8	XMLBWT-00-0000-000HT40Z8		
		T3	220	XMLBWT-00-0000-000LT30Z8	XMLBWT-00-0000-000HT30Z8		
		T2	200	XMLBWT-00-0000-000LT20Z8	XMLBWT-00-0000-000HT20Z8		
		S6	182	XMLBWT-00-0000-000LS60Z8	XMLBWT-00-0000-000HS60Z8		
		S5	172			XMLBWT-00-0000-000PS50Z8	XMLBWT-00-0000-000US50Z8
		S4	164			XMLBWT-00-0000-000PS40Z8	XMLBWT-00-0000-000US40Z8
		S3	156			XMLBWT-00-0000-000PS30Z8	XMLBWT-00-0000-000US30Z8

* Cree XLamp XM Family LED order codes specify only a minimum flux bin and not a maximum. Cree may ship reels in flux bins higher than the minimum specified by the order code without advance notice. Shipments will always adhere to the chromaticity or DWL bin restrictions specified by the order code.

STANDARD ORDER CODES AND BINS (XM-L HIGH VOLTAGE ANSI COOL WHITE, $T_j = 85\text{ }^\circ\text{C}$)

XLamp XM-L HVW LED Standard Order Codes - White				
Chromaticity		Minimum Luminous Flux (lm) @ 44 mA*		Order Codes
Kit	CCT	Code	Flux (lm)	65 CRI Typical
ANSI Cool White (5000 K – 8300 K)				
51	6200 K	T5	260	XMLHVW-Q0-0000-0000LT551
		T4	240	XMLHVW-Q0-0000-0000LT451
		T3	220	XMLHVW-Q0-0000-0000LT351
		T2	200	XMLHVW-Q0-0000-0000LT251
53	6000 K	T5	260	XMLHVW-Q0-0000-0000LT553
		T4	240	XMLHVW-Q0-0000-0000LT453
		T3	220	XMLHVW-Q0-0000-0000LT353
		T2	200	XMLHVW-Q0-0000-0000LT253
50	6200 K	T5	260	XMLHVW-Q0-0000-0000LT550
		T4	240	XMLHVW-Q0-0000-0000LT450
		T3	220	XMLHVW-Q0-0000-0000LT350
		T2	200	XMLHVW-Q0-0000-0000LT250

* Cree XLamp XM Family LED order codes specify only a minimum flux bin and not a maximum. Cree may ship reels in flux bins higher than the minimum specified by the order code without advance notice. Shipments will always adhere to the chromaticity or DWL bin restrictions specified by the order code.

STANDARD ORDER CODES AND BINS (XM-L HIGH VOLTAGE ANSI NEUTRAL WHITE, $T_j = 85\text{ }^\circ\text{C}$)

XLamp XM-L HVW LED Standard Kit Codes - White					
Chromaticity		Minimum Luminous Flux (lm) @ 44 mA*		Order Codes	
Kit	CCT	Code	Flux (lm)	75 CRI Typical	80 CRI Minimum
ANSI Neutral White (3700 K – 5000 K)					
E3	5000 K	T5	260	XMLHVW-Q0-0000-0000LT5E3	
		T4	240	XMLHVW-Q0-0000-0000LT4E3	
		T3	220	XMLHVW-Q0-0000-0000LT3E3	
		T2	200	XMLHVW-Q0-0000-0000LT2E3	
		S6	182	XMLHVW-Q0-0000-0000LS6E3	
F4	4750 K	T5	260	XMLHVW-Q0-0000-0000LT5F4	
		T4	240	XMLHVW-Q0-0000-0000LT4F4	
		T3	220	XMLHVW-Q0-0000-0000LT3F4	
		T2	200	XMLHVW-Q0-0000-0000LT2F4	
		S6	182	XMLHVW-Q0-0000-0000LS6F4	
E4	4500 K	T5	260	XMLHVW-Q0-0000-0000LT5E4	
		T4	240	XMLHVW-Q0-0000-0000LT4E4	
		T3	220	XMLHVW-Q0-0000-0000LT3E4	
		T2	200	XMLHVW-Q0-0000-0000LT2E4	
		S6	182	XMLHVW-Q0-0000-0000LS6E4	
F5	4250 K	T3	220	XMLHVW-Q0-0000-0000LT3F5	
		T2	200	XMLHVW-Q0-0000-0000LT2F5	XMLHVW-Q0-0000-0000HT2F5
		S6	182	XMLHVW-Q0-0000-0000LS6F5	XMLHVW-Q0-0000-0000HS6F5
		S5	172	XMLHVW-Q0-0000-0000LS5F5	XMLHVW-Q0-0000-0000HS5F5
E5	4000 K	T3	220	XMLHVW-Q0-0000-0000LT3E5	
		T2	200	XMLHVW-Q0-0000-0000LT2E5	XMLHVW-Q0-0000-0000HT2E5
		S6	182	XMLHVW-Q0-0000-0000LS6E5	XMLHVW-Q0-0000-0000HS6E5
		S5	172	XMLHVW-Q0-0000-0000LS5E5	XMLHVW-Q0-0000-0000HS5E5

* Cree XLamp XM Family LED order codes specify only a minimum flux bin and not a maximum. Cree may ship reels in flux bins higher than the minimum specified by the order code without advance notice. Shipments will always adhere to the chromaticity or DWL bin restrictions specified by the order code.

STANDARD ORDER CODES AND BINS (XM-L HIGH VOLTAGE ANSI WARM WHITE, $T_j = 85^\circ\text{C}$)

XLamp XM-L HVW LED Standard Kit Codes - White					
Chromaticity		Minimum Luminous Flux (lm) @ 44 mA*		Order Codes	
Kit	CCT	Code	Flux (lm)	80 CRI Typical	80 CRI Minimum
ANSI Warm White (2700 K - 3750 K)					
F6	3750 K	T3	220	XMLHVW-Q0-0000-0000LT3F6	
		T2	200	XMLHVW-Q0-0000-0000LT2F6	XMLHVW-Q0-0000-0000HT2F6
		S6	182	XMLHVW-Q0-0000-0000LS6F6	XMLHVW-Q0-0000-0000HS6F6
		S5	172	XMLHVW-Q0-0000-0000LS5F6	XMLHVW-Q0-0000-0000HS5F6
		S4	164	XMLHVW-Q0-0000-0000LS4F6	XMLHVW-Q0-0000-0000HS4F6
E6	3500 K	T3	220	XMLHVW-Q0-0000-0000LT3E6	
		T2	200	XMLHVW-Q0-0000-0000LT2E6	XMLHVW-Q0-0000-0000HT2E6
		S6	182	XMLHVW-Q0-0000-0000LS6E6	XMLHVW-Q0-0000-0000HS6E6
		S5	172	XMLHVW-Q0-0000-0000LS5E6	XMLHVW-Q0-0000-0000HS5E6
		S4	164	XMLHVW-Q0-0000-0000LS4E6	XMLHVW-Q0-0000-0000HS4E6
F7	3250 K	T3	220	XMLHVW-Q0-0000-0000LT3F7	
		T2	200	XMLHVW-Q0-0000-0000LT2F7	XMLHVW-Q0-0000-0000HT2F7
		S6	182	XMLHVW-Q0-0000-0000LS6F7	XMLHVW-Q0-0000-0000HS6F7
		S5	172	XMLHVW-Q0-0000-0000LS5F7	XMLHVW-Q0-0000-0000HS5F7
		S4	164	XMLHVW-Q0-0000-0000LS4F7	XMLHVW-Q0-0000-0000HS4F7
		S3	156	XMLHVW-Q0-0000-0000LS3F7	XMLHVW-Q0-0000-0000HS3F7
E7	3000 K	T3	220	XMLHVW-Q0-0000-0000LT3E7	
		T2	200	XMLHVW-Q0-0000-0000LT2E7	XMLHVW-Q0-0000-0000HT2E7
		S6	182	XMLHVW-Q0-0000-0000LS6E7	XMLHVW-Q0-0000-0000HS6E7
		S5	172	XMLHVW-Q0-0000-0000LS5E7	XMLHVW-Q0-0000-0000HS5E7
		S4	164	XMLHVW-Q0-0000-0000LS4E7	XMLHVW-Q0-0000-0000HS4E7
		S3	156	XMLHVW-Q0-0000-0000LS3E7	XMLHVW-Q0-0000-0000HS3E7
F8	2850 K	S6	182	XMLHVW-Q0-0000-0000LS6F8	XMLHVW-Q0-0000-0000HS6F8
		S5	172	XMLHVW-Q0-0000-0000LS5F8	XMLHVW-Q0-0000-0000HS5F8
		S4	164	XMLHVW-Q0-0000-0000LS4F8	XMLHVW-Q0-0000-0000HS4F8
		S3	156	XMLHVW-Q0-0000-0000LS3F8	XMLHVW-Q0-0000-0000HS3F8
		S2	148	XMLHVW-Q0-0000-0000LS2F8	XMLHVW-Q0-0000-0000HS2F8
E8	2700 K	S6	182	XMLHVW-Q0-0000-0000LS6E8	XMLHVW-Q0-0000-0000HS6E8
		S5	172	XMLHVW-Q0-0000-0000LS5E8	XMLHVW-Q0-0000-0000HS5E8
		S4	164	XMLHVW-Q0-0000-0000LS4E8	XMLHVW-Q0-0000-0000HS4E8
		S3	156	XMLHVW-Q0-0000-0000LS3E8	XMLHVW-Q0-0000-0000HS3E8
		S2	148	XMLHVW-Q0-0000-0000LS2E8	XMLHVW-Q0-0000-0000HS2E8

* Cree XLamp XM Family LED order codes specify only a minimum flux bin and not a maximum. Cree may ship reels in flux bins higher than the minimum specified by the order code without advance notice. Shipments will always adhere to the chromaticity or DWL bin restrictions specified by the order code.