



■ Features :

- DC/DC step-down converter
- Constant current output: 300mA to 700mA
- Wide input voltage: 9 ~ 36VDC
- Wide output LED string voltage: 2 ~ 32VDC
- High efficiency up to 95%
- Built-in EMI filter, comply with EN55015 and FCC part15 without additional input filter and capacitors
- Built-in PWM dimming and remote ON/OFF control
- Protections: Short circuit / Over temperature
- Cooling by free air convection
- Fully encapsulated with IP67 level for pin and wire style
- Compact size
- Low cost, high reliability
- Suitable for driving illumination LED
- 3 years warranty



LDD-350L  Blank : pin style  
 W : wire style  
 S : SMD style

**SPECIFICATION**

ORDER NO.		LDD-300L <input type="checkbox"/>	LDD-350L <input type="checkbox"/>	LDD-500L <input type="checkbox"/>	LDD-600L <input type="checkbox"/>	LDD-700L <input type="checkbox"/>	
OUTPUT	CURRENT RANGE	300mA	350mA	500mA	600mA	700mA	
	VOLTAGE RANGE <small>Note.4</small>	2 ~ 32VDC for LDD-300~700L/LW ; 2~ 28VDC for LDD-300~700LS					
	CURRENT ACCURACY (Typ.)	±5% at 24VDC input					
	RIPPLE & NOISE(max.) <small>Note.2</small>	150mVp-p	150mVp-p	150mVp-p	200mVp-p	200mVp-p	
	SWITCHING FREQUENCY	40KHz ~ 1000KHz					
	EXTERNAL CAPACITANCE LOAD (max.)	2.2uF					
INPUT	VOLTAGE RANGE	9 ~ 36VDC for LDD-300~700L/LW ; 9~ 32VDC for LDD-300~700LS					
	EFFICIENCY (max.)	95% at full load and 24VDC/36VDC input for LDD-300~700L/LW ; 95% at full load and 24VDC input for LDD-300~700LS					
	DC CURRENT	Full load <small>Note.3</small>	300mA	350mA	500mA	600mA	700mA
		No load	5mA				
FILTER	Capacitor						
PWM DIMMING & ON/OFF CONTROL	REMOTE ON/OFF	Leave open if not use Power ON with dimming: DIM ~ -Vin >3.5 ~ 8VDC or open circuit Power OFF : DIM ~ -Vin < 0.5VDC or short					
	PWM FREQUENCY	100 ~ 1KHz					
	QUIESCENT INPUT CURRENT IN SHUTDOWN MODE(max.)	1mA at PWM dimming OFF and 24VDC input					
PROTECTION	SHORT CIRCUIT	Regulated at rated output current Protection type: Can be continued, recovers automatically after fault condition is removed					
	OVER TEMPERATURE	Tj 150°C typically(IC1) detect on main control IC Protection type : Shut down, recovers automatically after temperature goes down					
ENVIRONMENT	WORKING TEMP.	-40 ~ + 85°C (Refer to derating curve)					
	WORKING HUMIDITY	20% ~ 90% RH non-condensing for LDD-300~700L/LW ; 20% ~ 85% RH non-condensing for LDD-300~700LS					
	STORAGE TEMP., HUMIDITY	-55 ~ +125°C, 10 ~ 95% RH					
	TEMP. COEFFICIENT	±0.03% / °C					
	VIBRATION	10 ~ 500Hz, 2G 10min./1 cycle, period for 60min. each along X, Y, Z axes					
	OPERATING CASE TEMP. (max.)	100°C					
EMC	EMC EMISSION	Compliance to EN55015, FCC part 15 class B					
	EMC IMMUNITY	Compliance to EN61000-4-2,3,4,6,8, light industry level, criteria A					
OTHERS	MTBF	2000Khrs min. MIL-HDBK-217F (25°C)					
	DIMENSION	22.6*9.9*8.9mm or 0.89**0.39**0.35" inch (L*W*H) for LDD-300~700L/LW ; 25.4*10.5*9.3mm or 1**0.4135**0.366" inch (L*W*H) for LDD-300~700LS					
	WEIGHT	LDD-300~700L:4g ; LDD-300~700LW:7.3g ; LDD-300~700LS :3.4g					
	POTTING MATERIAL	Expoxy(UL94-V0) for LDD-300~700L/LW ; without potted for LDD-300~700LS					
NOTE	1.All parameters are specified at normal input(24VDC), rated load, 25°C 70% RH ambient. 2.Ripple & noise are measured at 20MHz by using a 12" twisted pair terminated with a 0.1uf capacitor. 3.Test condition: 24VDC input. 4.Output voltage will always step down by 3 volts from input DC voltage. 5.The output of LDD-L should not be connected to the input of the same unit or output from other sources.						

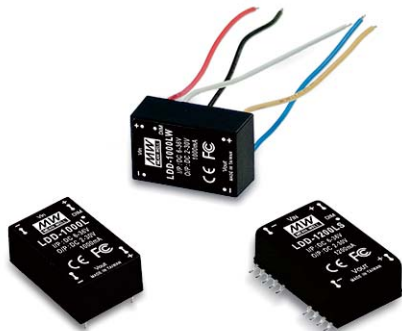

### ■ Features :

- DC/DC step-down converter
- Constant current output: 1000mA to 1500mA
- Wide input voltage: 6 ~ 36VDC
- Wide output LED string voltage: 2 ~ 30VDC
- High efficiency up to 95%
- Built-in EMI filter, comply with EN55015 and FCC part15 without additional input filter and capacitors
- Built-in PWM +analog dimming and remote ON/OFF control
- Protections: Short circuit
- Cooling by free air convection
- Fully encapsulated with IP67 level for pin and wire style
- Non-potted, optional conformal coating for SMD style (Order No.: LDD-1000LSC)
- Compact size
- Low cost, high reliability
- Suitable for driving illumination LED
- 3 years warranty



LDD-1000L  W Blank : pin style  
W : wire style  
S : SMD style

### SPECIFICATION

ORDER NO.	LDD-1000L <input type="checkbox"/>	LDD-1200L <input type="checkbox"/>	LDD-1500L <input type="checkbox"/>		
OUTPUT	CURRENT RANGE	1000mA	1200mA	1500mA	
	VOLTAGE RANGE <small>Note.4</small>	2 ~ 30VDC			
	CURRENT ACCURACY (Typ.)	±5% at 24VDC input			
	RIPPLE & NOISE(max.) <small>Note.2</small>	1.5Vp-p	1.5Vp-p	1.5Vp-p	
	SWITCHING FREQUENCY	1000KHz			
EXTERNAL CAPACITANCE LOAD (max.)	2.2uF				
INPUT	VOLTAGE RANGE	6 ~ 36VDC			
	EFFICIENCY (max.)	95% at full load and 24VDC/36VDC input for LDD-1000~1500L/LW			
	DC CURRENT	Full load <small>Note.3</small>	990mA	1160mA	1450mA
		No load	5mA		
FILTER	Capacitor				
PWM DIMMING & ON/OFF CONTROL	REMOTE ON/OFF	Leave open if not use			
		Power ON with dimming: DIM ~ -Vin >2.6 ~ 5.5VDC or open circuit			
		Power OFF : DIM ~ -Vin < 0.4VDC or short			
PWM FREQUENCY	100 ~ 500Hz				
QUIESCENT INPUT CURRENT IN SHUTDOWN MODE(max.)	1mA at PWM dimming OFF and 24VDC input				
ANALOG DIMMING & ON/OFF CONTROL	REMOTE ON / OFF	Leave open if not use			
		Power ON with dimming : DIM ~ -Vin>0.5~2.5VDC or open circuit			
		Power OFF : DIM ~ -Vin<0.4VDC or short			
PROTECTION	SHORT CIRCUIT	Regulated at rated output current Protection type: Can be continued, recovers automatically after fault condition is removed			
ENVIRONMENT	WORKING TEMP.	-40 ~ + 71°C (Refer to derating curve)			
	WORKING HUMIDITY	20% ~ 90% RH non-condensing for LDD-1000~1500L/LW ; 20%~85% RH non-condensing for LDD-1000~1500LS			
	STORAGE TEMP., HUMIDITY	-55 ~ +125°C, 10 ~ 95% RH			
	TEMP. COEFFICIENT	±0.03% / °C			
	VIBRATION	10 ~ 500Hz, 2G 10min./1 cycle, period for 60min. each along X, Y, Z axes			
OPERATING CASE TEMP. (max.)	100°C				
EMC	EMC EMISSION	Compliance to EN55015, FCC part 15 class B			
	EMC IMMUNITY	Compliance to EN61000-4-2,3,4,6,8, light industry level, criteria A			
OTHERS	MTBF	2000Khrs min. MIL-HDBK-217F (25°C)			
	DIMENSION	31.8*20.3*12.2mm or 1.25**0.8**0.48" inch (L*W*H) for LDD-1000~1500L/LW ; 31.8*20.3*10.9mm or 1.25**0.8**0.43" inch (L*W*H) for LDD-1000~1500LS			
	WEIGHT	LDD-1000~1500L:15.6g ; LDD-1000~1500LW:18g ; LDD-1000~1500LS:12.8g			
	POTTING MATERIAL	Expoxy(UL94-V0) for LDD-1000~1500L/LW ; without potted for LDD-1000~1500LS			
NOTE	1. All parameters are specified at normal input(24VDC), rated load, 25°C 70% RH ambient. 2. Ripple & noise are measured at 20MHz by using a 12" twisted pair terminated with a 0.1uf capacitor. 3. Test condition: 36VDC input. 4. Output voltage will always step down by 3 volts from input DC voltage. 5. The output of LDD-L should not be connected to the input of the same unit or output from other sources.				

**Mechanical Specification**

Blank type(LDD-300~700L):

Unit: mm (inch)

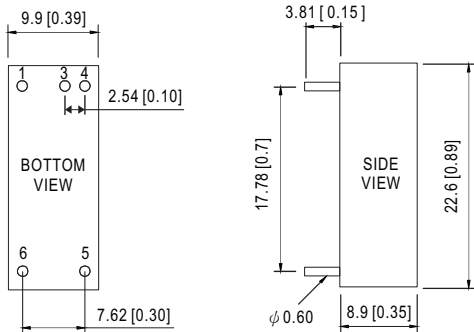

NOTE: Pin tolerance  $\pm 0.05\text{mm}$

W type(LDD-300~700LW):

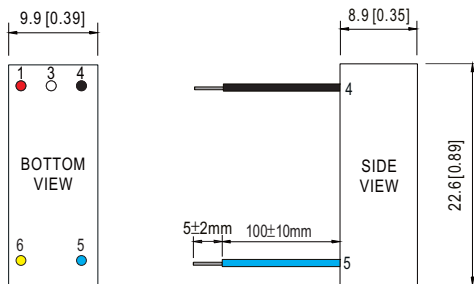

NOTE: All wires UL3385 22AWG

S type(LDD-300~700LS):

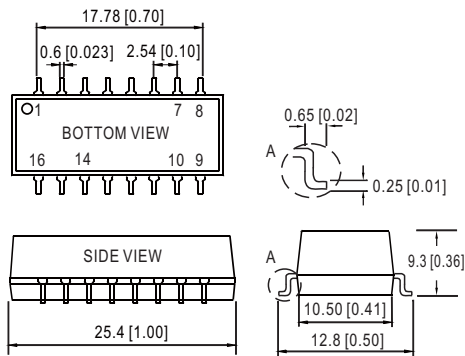

**Recommended PCB layout (for LDD-300~700LS)**

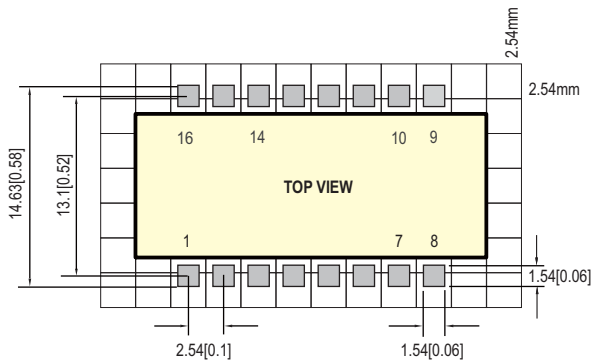

**Pin Configuration**

Pin No.	Comment
1	+Vin DC Supply
3	PWM DIM ON/OFF and PWM Dimming (Leave open if not used)
4	-Vin Don't connect to -Vout
5	-Vout LED - Connection
6	+Vout LED + Connection

Pin No.	Comment
1	+Vin (Red) DC Supply
3	PWM DIM (White) ON/OFF and PWM Dimming (Leave open if not used)
4	-Vin (Black) Don't connect to -Vout
5	-Vout (Blue) LED - Connection
6	+Vout (Yellow) LED + Connection

Pin No.	Comment
1	+Vin DC Supply
7,8	+Vout LED + Connection
9,10	-Vout LED - Connection
14	PWM DIM ON/OFF and PWM Dimming (Leave open if not used)
16	-Vin Don't connect to -Vout
others	N.C LED - Connection

**Mechanical Specification**

**Blank type(LDD – 1000~1500L):**

Unit: mm (inch)

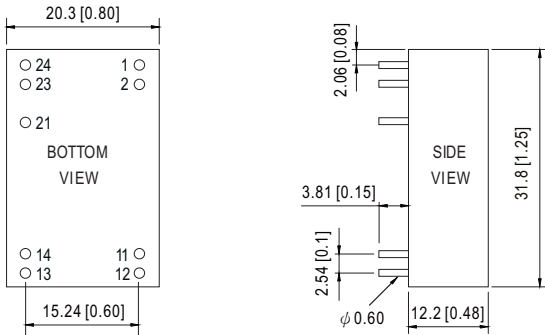

NOTE: Pin tolerance  $\pm 0.05\text{mm}$

**W type(LDD – 1000~1500LW):**

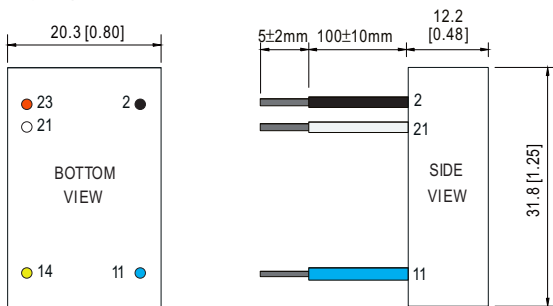

NOTE: All wires UL3385 22AWG

**S type(LDD – 1000~1500LS):**

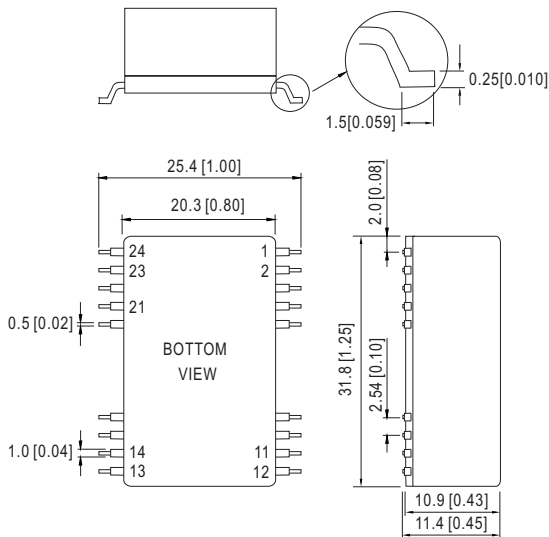

**Recommended PCB layout (for LDD-1000~1500LS)**

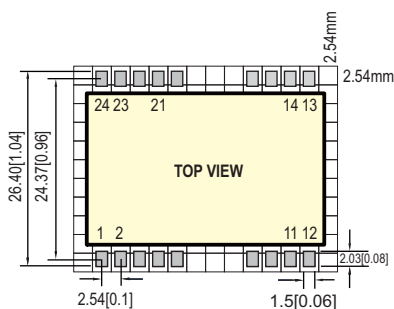

**Pin Configuration**

Pin No.		Comment
1,2	-Vin	Don't connect to -Vout
11,12	-Vout	LED - Connection
13,14	+Vout	LED + Connection
21	PWM +analog DIM	ON/OFF and PWM / analog Dimming (Leave open if not used)
23,24	+Vin	DC Supply

Pin No.		Comment
2	-Vin (Black)	Don't connect to -Vout
11	-Vout (Blue)	LED - Connection
14	+Vout (Yellow)	LED + Connection
21	PWM +analog DIM (White)	ON/OFF and PWM / analog Dimming (Leave open if not used)
23	+Vin (Red)	DC Supply

Pin No.		Comment
1,2	-Vin	Don't connect to -Vout
11,12	-Vout	LED - Connection
13,14	+Vout	LED + Connection
21	PWM +analog DIM	ON/OFF and PWM / analog Dimming (Leave open if not used)
23,24	+Vin	DC Supply
others	N.C	No connection

■ Reflow Soldering Curve (for LDD-300~1500LS)

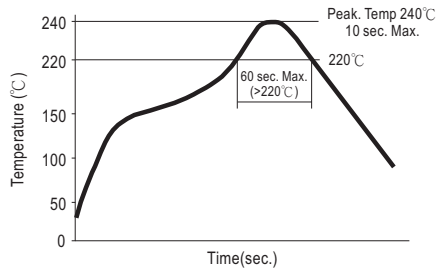

Remark : The curve applies only to the " Hot Air Reflow Soldering"

■ Derating Curve

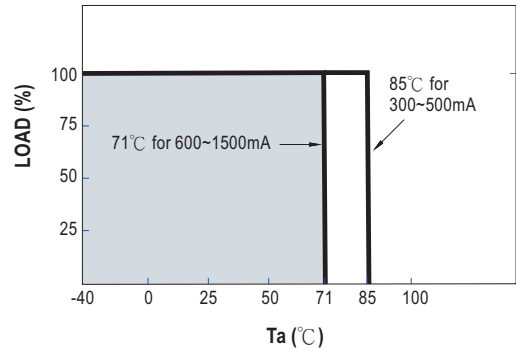

■ PWM Dimming Control (for 300~1500mA)

To Adjustment by PWM signal :

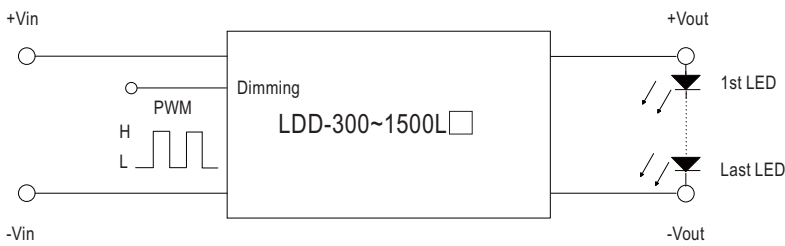

300 ~ 700mA :

H: > 3.5~8VDC or open circuit

L: < 0.5VDC or short

1000 ~ 1500mA :

H: > 2.6~5.5VDC or open circuit

L: < 0.4VDC or short

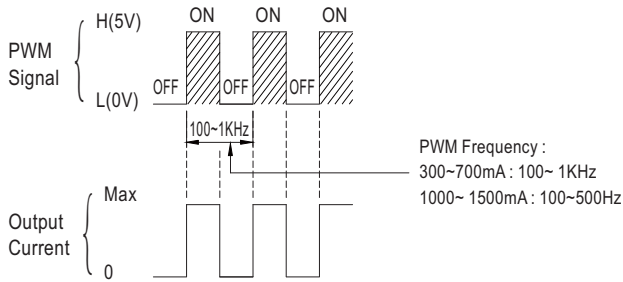

© During PWM dimming operation, the output current will change to PWM style.

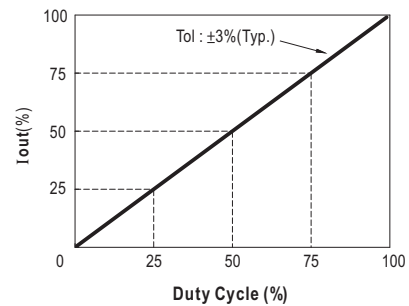

■ Analog Dimming Control for 1000~ 1500mA only

To Adjustment by DC voltage :

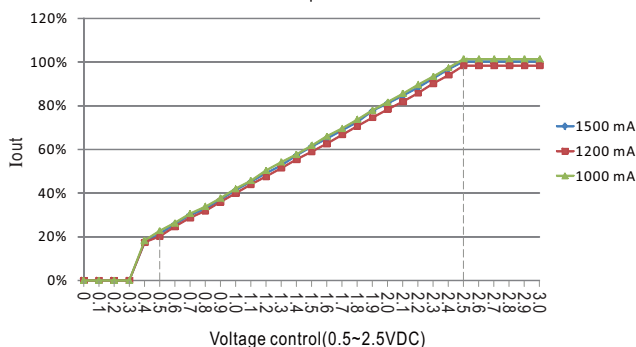
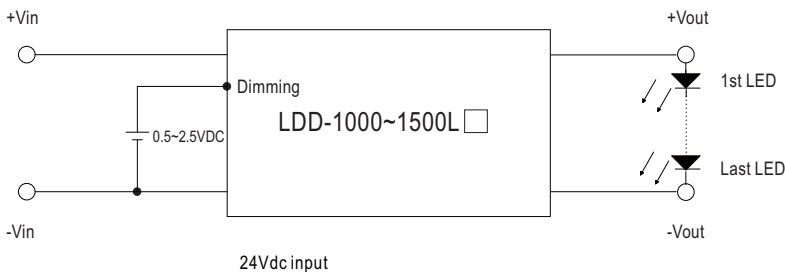

■ Efficiency VS Output Voltage(Number of LEDs)

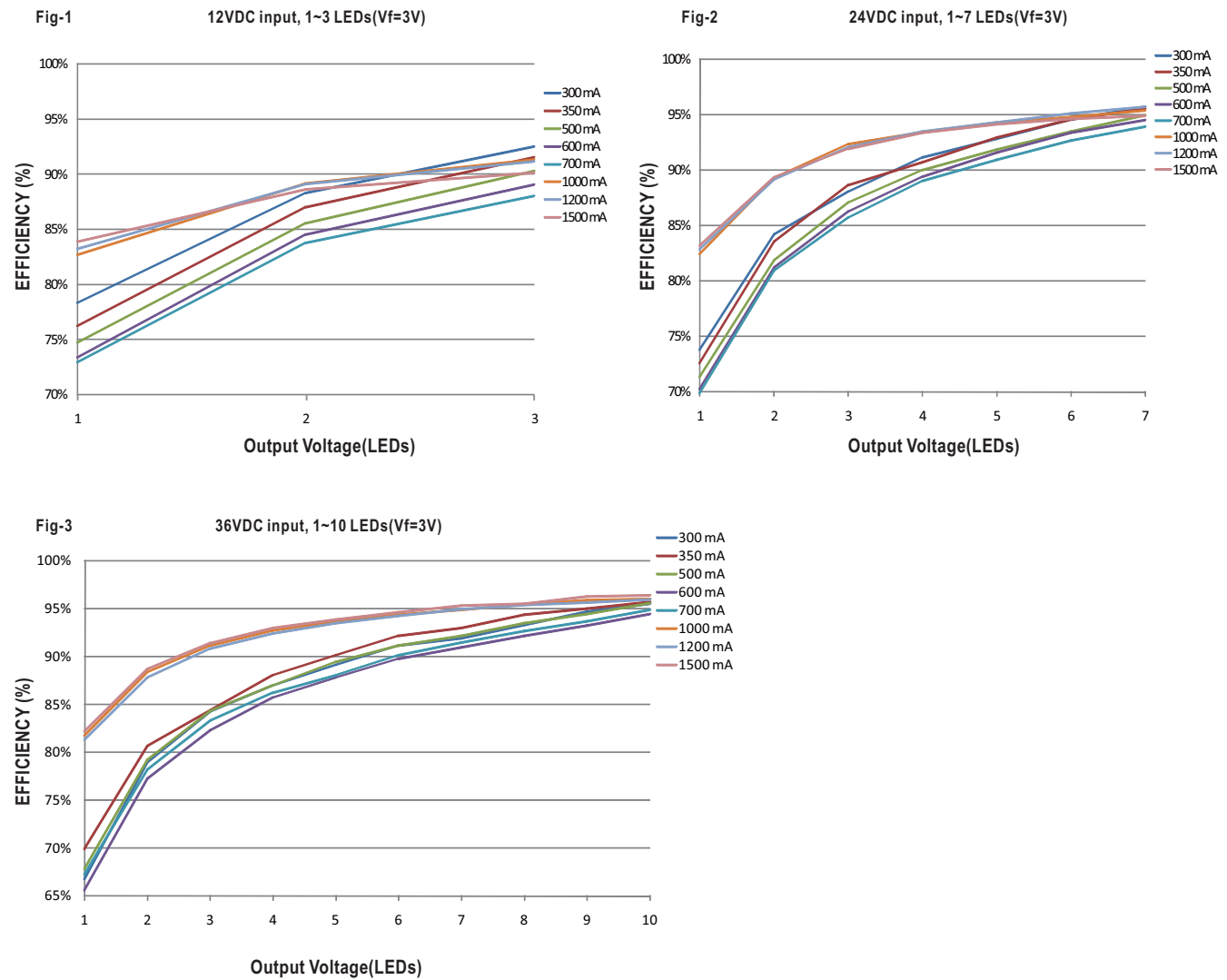

# Mouser Electronics

Authorized Distributor

Click to View Pricing, Inventory, Delivery & Lifecycle Information:

## Mean Well:

[LDD-300L](#) [LDD-350L](#) [LDD-500L](#) [LDD-600L](#) [LDD-700L](#) [LDD-300LS](#) [LDD-350LS](#) [LDD-500LS](#) [LDD-600LS](#) [LDD-700LS](#) [LDD-1200L](#) [LDD-1500L](#) [LDD-1000LS](#) [LDD-1200LS](#) [LDD-1000L](#) [LDD-1500LS](#)