



SPECIFICATIONS of MULTILAYER CHIP CAPACITOR

**NP0, X7R, Y5V
10V ~ 3000V
0402 (1005) ~ 1812 (4532)
0.5pF ~ 22 μ F**

Version 2002NOV

Contents

1.	MLCC Part Number Codes (No.21-S-004.D)	Page 3
2.	NPO Specifications (No.21-S-004.D)	Page 4~5
3.	X7R Specifications (No.21-S-004.D)	Page 6~7
4.	Y5V Specifications (No.21-S-004.D)	Page 8~10
5.	Tolerance and Capacitance (No.21-S-004.D)	Page 10
6.	Dimension Length,Width and MB (No.21-S-004.D)	Page 11
7.	NPO Capacitance and Voltage (No.21-S-004.D)	Page 12
8.	NPO Capacitance and High-Voltage (No.21-S-004.D)	Page 13
9.	X7R Capacitance and Voltage (No.21-S-004.D)	Page 14
10.	X7R Capacitance and High-Voltage (No.21-S-004.D)	Page 15
11.	Y5V Capacitance and Voltage (No.21-S-004.D)	Page 16
12.	Y5V Capacitance and High-Voltage (No.21-S-004.D)	Page 17
13.	Packing on Tape and Reel (No.21-S-004.D)	Page 18~20
14.	Description of the Standard Shipping Label (No.21-S-004.D)	Page 21
15.	Appendix I : Bending Test (No.21-S-004.D)	Page 22
16.	Appendix II : Adhesive Strength of Termination (No.21-S-004.D)	Page 23



MLCC PART NUMBER CODES HOW TO ORDER

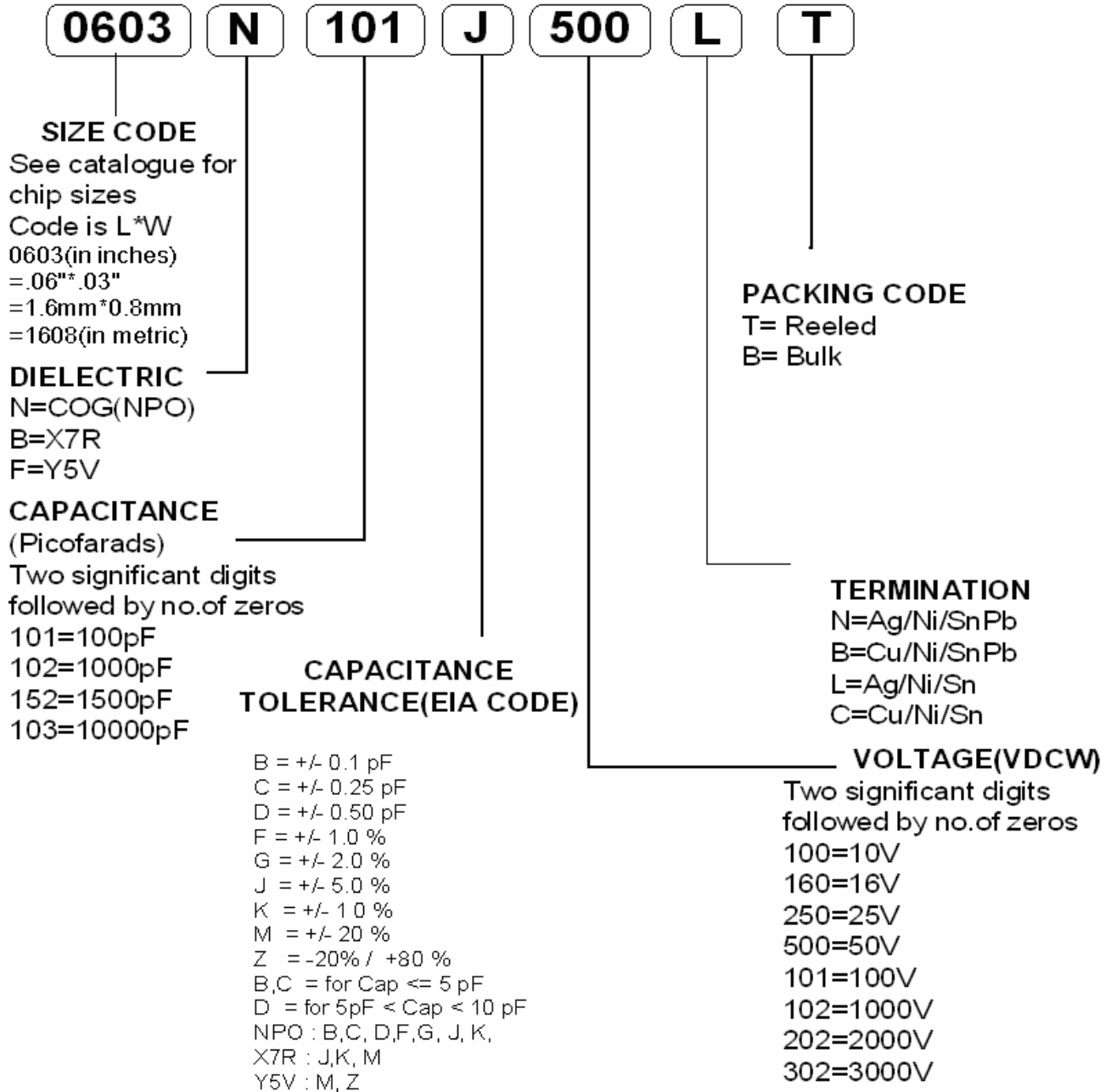

For values below 10 pF, use "R" in place of decimal point, e.g., 4.7pF=4R7

NPO SERIAL PRODUCTS SPECIFICATIONS

Above product satisfies the requirements as follow :

NO.	Test Items	Test Condition	Requirements														
1.	Visual & Mechanical		<ul style="list-style-type: none"> No remarkable defect. Dimensions to conform to individual specification sheet. 														
2.	Capacitance	$\leq 1000\text{pF}$ $1.0 \pm 0.2\text{Vrms}$, $1\text{MHz} \pm 10\%$ $> 1000\text{pF}$ $1.0 \pm 0.2\text{Vrms}$, $1\text{KHz} \pm 10\%$	<ul style="list-style-type: none"> Shall not exceed the limits given in the detailed spec. 														
3.	Q Value	$\leq 1000\text{pF}$ $1.0 \pm 0.2\text{Vrms}$, $1\text{MHz} \pm 10\%$ $> 1000\text{pF}$ $1.0 \pm 0.2\text{Vrms}$, $1\text{KHz} \pm 10\%$	<ul style="list-style-type: none"> More than 30pF: $Q \geq 1000$ Less than 30pF: $Q \geq 400 + 20C$ 														
4.	Dielectric strength	<ul style="list-style-type: none"> To apply voltage (<50V) : 250% of rated voltage for 1~5 sec. Charge & discharge current less than 50mA. 	No evidence of damage or flash over during test.														
		<table border="1" style="width: 100%; border-collapse: collapse;"> <tr> <td style="width: 30%;">100V</td> <td style="width: 30%;">Cut-off, set at 10mA</td> <td style="width: 30%;">100V</td> <td style="width: 10%;">≥ 3 times V DC</td> </tr> <tr> <td>200V ~ 300V</td> <td>TEST= 15</td> <td>200V ~ 300V</td> <td>≥ 2 times V DC</td> </tr> <tr> <td>500V ~ 999V</td> <td>RAMP=0</td> <td>500V ~ 999V</td> <td>≥ 1.5 times V DC</td> </tr> <tr> <td>1000 ~ 3000V</td> <td></td> <td>1000V ~ 3000V</td> <td>≥ 1.2 times V DC</td> </tr> </table>	100V	Cut-off, set at 10mA	100V	≥ 3 times V DC	200V ~ 300V	TEST= 15	200V ~ 300V	≥ 2 times V DC	500V ~ 999V	RAMP=0	500V ~ 999V	≥ 1.5 times V DC	1000 ~ 3000V		1000V ~ 3000V
100V	Cut-off, set at 10mA	100V	≥ 3 times V DC														
200V ~ 300V	TEST= 15	200V ~ 300V	≥ 2 times V DC														
500V ~ 999V	RAMP=0	500V ~ 999V	≥ 1.5 times V DC														
1000 ~ 3000V		1000V ~ 3000V	≥ 1.2 times V DC														
5.	Insulation resistance	To apply rated voltage for max. 120sec.	10G Ω MIN. or 500 Ω -F MIN. , whichever is smaller.														
		Rated Voltage: 100V ~ 500V	To apply rated voltage	> 10G Ω													
		Rated Voltage: >500V	To apply 500V*60sec	> 10G Ω													
6.	Temperature coefficient	With no electrical load -55 ~ 125°C at 25°C	Within $\pm 30\text{ppm}/^\circ\text{C}$														
7.	Bending test	<ul style="list-style-type: none"> The middle part of substrate shall be pressurized by means of the pressurizing rod at a rate of about 1 mm per second until the deflection becomes 1 mm and then the pressure shall be maintained for 5 ± 1 sec. (Appendix 1) Measurement to be made after keeping at room temp. for 24 ± 2 hours 	<ul style="list-style-type: none"> No remarkable damage. Cap change : $\pm 5.0\%$ MAX. or $\pm 0.5\text{pF}$ MAX. , whichever is larger. <p>This capacitance change means the change of Capacitance under specified flexure of substrate from the capacitance measured before the test.</p>														
8.	Solderability	<ul style="list-style-type: none"> Solder temperature : $230 \pm 5^\circ\text{C}$ Dipping time : 2 ± 0.5 sec Solder : SN63A 	90% MIN. coverage of all metalized area.														
9.	Resistance to soldering heat	<ul style="list-style-type: none"> Solder temperature : $260 \pm 5^\circ\text{C}$ Dipping time : 10 ± 1 sec Solder : SN63A Measurement to be made after keeping at room temp. for 24 ± 2 hours. 	<ul style="list-style-type: none"> No remarkable damage. Cap change : $\pm 2.5\%$ MAX. or $\pm 0.25\text{pF}$ MAX. , whichever is larger. Q & I.R. & Dielectric strength : To meet initial requirements. 25% max. Leaching on each edge. 														

NO.	Test Items	Test Condition	Requirements
10.	Temperature cycle	<ul style="list-style-type: none"> Test temp. : -55°C ~ 125°C Test step : 1) -55°C -3/+0 °C 30±3 min. 2) room temp. 2~3 min. 3) 125°C +3/-0 °C 30±2min. 4) room temp. 2~3 min. Conduct the five cycles according to the temperatures and time. Measurement to be made after keeping at room temp. for 24±2 hours. 	<ul style="list-style-type: none"> No remarkable damage. Cap change : ±2.5% MAX. or ±0.25pF MAX. , whichever is larger. Q & I.R. & Dielectric strength : To meet initial requirements.
11	Humidity (Damp Heat) steady state	<ul style="list-style-type: none"> Test temp. : 40±2°C Humidity : 90~95%RH Test time : 1000+24/-0hrs. Measurement to be made after keeping at room temp. for 24 ±2 hrs. 	<ul style="list-style-type: none"> No remarkable damage. Cap change : ±5.0% MAX. or ±0.5pF MAX. , whichever is larger. Q value : More than 30pF Q≥350 10pF≤C<30pF Q≥275+2.5C Less than 10pF Q≥200+10C I.R. : 1GΩ MIN. or 50Ω-F MIN., whichever is smaller.
12.	Humidity (Damp Heat) Load	<ul style="list-style-type: none"> Test temp. : 40±2°C Humidity : 90~95%RH Test time : 1000+24/-0hrs. To apply voltage : rated voltage (Max. 500V) Measurement to be made after keeping at room temp. for 24 ±2 hours. 	<ul style="list-style-type: none"> No remarkable damage. Cap change : ±7.5%MAX. or ±0.75pF MAX. , whichever is larger. Q value : More than 30pF Q≥200 C< 30pF Q≥100+10/3C I.R. : 500MΩ MIN. or 25Ω-F MIN. , whichever is smaller.
13.	Adhesive strength of termination	<ul style="list-style-type: none"> Pressurizing force : 1kg (10N) Test time : 10 ±1 sec (Appendix 2) 	<ul style="list-style-type: none"> No remarkable damage or removal of the terminations.
14.	Vibration Resistance	<ul style="list-style-type: none"> Vibration frequency : 10~55 Hz/min. Total amplitude : 1.5mm Test time : 6 hrs.(Two hours each in three mutually perpendicular directions.) 	<ul style="list-style-type: none"> No remarkable damage. Cap change & Q : To meet initial requirements.
15.	High Temperature Load (Endurance)	<ul style="list-style-type: none"> Test temp. : 125±3°C To apply voltage : V<500V : 200% of rated voltage. V≥500V, <1000V : 150% of rated voltage. V≥1000V : 120% of rated voltage.(Max.3600V) Test time : 1000+24/-0 hrs. Measurement to be made after keeping at room temp. for 24 ±2 hours. 	<ul style="list-style-type: none"> No remarkable damage. Cap change : ±3.0% MAX. or ±0.3pF MAX. , whichever is larger. Q value : More than 30pF Q≥350 10pF≤C<30pF Q≥275+2.5C Less than 10pF Q≥200+10C I.R. : 1GΩ MIN. or 50Ω-F MIN., whichever is smaller.

X7R SERIAL PRODUCTS SPECIFICATIONS

Above product satisfies the requirements as follow

NO.	Test Items	Test Condition	Requirements														
1.	Visual & Mechanical		<ul style="list-style-type: none"> No remarkable defect. Dimensions to conform to individual specification sheet. 														
2.	Capacitance	1.0±0.2Vrms · 1KHz±10%	<ul style="list-style-type: none"> Shall not exceed the limits given in the detailed spec. 														
3.	Dissipation factor	1.0±0.2Vrms · 1KHz±10%	<ul style="list-style-type: none"> ≤2.5% Rated voltage : ≥50V ≤3.5% Rated voltage : 25V, 16V ≤5.0% Rated g voltage : 10V 														
4.	Dielectric strength	<ul style="list-style-type: none"> To apply voltage(<50V) : 250% of rated voltage for 1~5 sec. Charge & discharge current less than 50mA 	No evidence of damage or flash over during test.														
		<table border="1"> <tr> <td>100V</td> <td>Cut off, set at 10mA</td> <td>100V</td> <td>≥ 3 times V DC</td> </tr> <tr> <td>200V ~ 300V</td> <td>TEST=15</td> <td>200V ~ 300V</td> <td>≥ 2 times V DC</td> </tr> <tr> <td>500V ~ 999V</td> <td>RAMP=0</td> <td>500V~ 999V</td> <td>≥ 1.5 times V DC</td> </tr> <tr> <td>1000V ~ 3000V</td> <td></td> <td>1000V ~ 3000V</td> <td>≥ 1.2 times V DC</td> </tr> </table>	100V	Cut off, set at 10mA	100V	≥ 3 times V DC	200V ~ 300V	TEST=15	200V ~ 300V	≥ 2 times V DC	500V ~ 999V	RAMP=0	500V~ 999V	≥ 1.5 times V DC	1000V ~ 3000V		1000V ~ 3000V
100V	Cut off, set at 10mA	100V	≥ 3 times V DC														
200V ~ 300V	TEST=15	200V ~ 300V	≥ 2 times V DC														
500V ~ 999V	RAMP=0	500V~ 999V	≥ 1.5 times V DC														
1000V ~ 3000V		1000V ~ 3000V	≥ 1.2 times V DC														
5.	Insulation resistance	To apply rated voltage for max. 120sec.	10GΩ MIN. or 500Ω-F MIN. , whichever is smaller.														
		Rated Voltage: 100V ~ 500V	To apply rated voltage > 10GΩ														
		Rated Voltage: > 500V	To apply 500V*60sec >10GΩ														
6.	Temperature coefficient	With no electrical load -55 ~ 125°C at 25°C	Within ±15%.														
7.	Bending test	<ul style="list-style-type: none"> The middle part of substrate shall be pressurized by means of the pressurizing rod at a rate of about 1 mm per second until the deflection becomes 1 mm and then the pressure shall be maintained for 5 sec. Appendix 1) Measurement to be made after keeping at room temp. for 24±2 hours 	<ul style="list-style-type: none"> No remarkable damage. Cap change : ≤±12.5%. <p>This capacitance change means the change of capacitance under specified flexure of substrate from the capacitance measured before the test.</p>														
8.	Solderability	<ul style="list-style-type: none"> Solder temperature : 230±5°C Dipping time : 2±0.5 sec Solder : SN63A 	90% MIN. coverage of all metalized area.														
9.	Resistance to soldering heat	<ul style="list-style-type: none"> Solder temperature : 260±5°C Dipping time : 10±1 sec Solder : SN63A Measurement to be made after keeping at room temp. for 48±4 hours. 	<ul style="list-style-type: none"> No remarkable damage. Cap change : < ±7.5% DF value & I.R : To meet initial standard value. Dielectric Strength : no defect. 25% max. Leaching on each edge. 														

NO.	Test Items	Test Condition	Requirements
10.	Temperature cycle	<ul style="list-style-type: none"> Test temp. : -55°C ~ 125°C Test step : <ol style="list-style-type: none"> 1) -55°C -3/+0 °C 30±3 min. 2) room temp. 2~3 min. 3) 125°C +3/-0 °C 30±2 min. 4) room temp. 2~3min. Conduct the five cycles according to the temperatures and time. Measurement to be made after keeping at room temp. for 48 ±4 hours. 	<ul style="list-style-type: none"> No remarkable damage. Cap change : <±7.5% D.F value & I.R. : To meet initial standard value.
11	Humidity (Damp Heat) steady state	<ul style="list-style-type: none"> Test temp. : 40±2°C Humidity : 90~95% RH Test time : 1000+24/-0 hrs. Measurement to be made after keeping at room temp. for 48±4 hrs. 	<ul style="list-style-type: none"> No remarkable damage. Cap change : <±12.5% DF value : <ul style="list-style-type: none"> ≤3.0% Rated voltage : 50V ≤5.0% Rated voltage : 25V, 16V ≤7.5% Rated voltage : 10V I.R. : 1GΩ MIN. or 50Ω-F MIN., whichever is smaller.
12.	Humidity (Damp Heat) Load	<ul style="list-style-type: none"> Test temp. : 40±2°C Humidity : 90~95% RH Test time : 1000+24/-0 hrs. To apply rated voltage (Max. 500V) Measurement to be made after keeping at room temp. for 48±2 hours. 	<ul style="list-style-type: none"> No remarkable damage. Cap change : <±12.5% DF value : <ul style="list-style-type: none"> ≤3.0% Rated voltage : 50V ≤5.0% Rated voltage : 25V, 16V ≤7.5% Rated voltage : 10V I.R. : 500MΩ MIN. or 25Ω-F MIN., whichever is smaller.
13.	Adhesive strength of termination	Pressurizing force : 1kg (10N) Test time : 10±1 sec (Appendix 2)	No remarkable damage or removal of the terminations.
14.	Vibration Resistance	<ul style="list-style-type: none"> Vibration frequency : 10~55 Hz/min. Total amplitude : 1.5mm Test time : 6 hrs.(Two hours each in three mutually perpendicular directions.) 	<ul style="list-style-type: none"> No remarkable damage. Cap change & DF : To meet initial requirements.
15.	High Temperature Load (Endurance)	<ul style="list-style-type: none"> Test temp. : 125±3°C To apply voltage : <ul style="list-style-type: none"> V<500V : 200% of rated voltage. V≥500V, <1000V : 150% of rated voltage. V≥1000V : 120% of rated voltage.(Max.3600V) Test time : 1000+24/-0 hrs. Measurement to be made after keeping at room temp. for 48±4 hours. 	<ul style="list-style-type: none"> No remarkable damage. Cap change : <±12.5% DF value : <ul style="list-style-type: none"> ≤3.0% Rated voltage : 50V ≤5.0% Rated voltage : 25V, 16V ≤7.5% Rated voltage : 10V I.R. : 1GΩ MIN. or 50Ω-F MIN., whichever is smaller.

Y5V SERIAL PRODUCTS SPECIFICATIONS

Above product satisfies the requirements as follow :

NO.	Test Items	Test Condition	Requirements														
1.	Visual & Mechanical		<ul style="list-style-type: none"> No remarkable defect. Dimensions to conform to individual specification sheet. 														
2.	Capacitance	$C \leq 22\mu\text{F}$, $1.0 \pm 0.2\text{Vrms}$, $1\text{KHz} \pm 10\%$ $C > 22\mu\text{F}$, $0.5 \pm 0.1\text{Vrms}$, $120\text{Hz} \pm 10\text{Hz}$, 25°C	<ul style="list-style-type: none"> Shall not exceed the limits given in the detailed spec. 														
3.	Dissipation factor	$C \leq 22\mu\text{F}$, $1.0 \pm 0.2\text{Vrms}$, $1\text{KHz} \pm 10\%$ $C > 22\mu\text{F}$, $0.5 \pm 0.1\text{Vrms}$, $120\text{Hz} \pm 10\text{Hz}$, 25°C	<ul style="list-style-type: none"> $DF \leq 5.0\%$ ($\geq 50\text{V}$) $DF \leq 5.0\%$ (25V) [Except 0603 $\geq 0.1\mu\text{F}$, 0805 $\geq 0.33\mu\text{F}$, 1206 $\geq 1\mu\text{F}$, $DF \leq 7\%$] $DF \leq 7.0\%$ ($C < 1.0\mu\text{F}$, 16V) [Except 0402 $\geq 0.068\mu\text{F}$; $DF \geq 9\%$] $DF \geq 9.0\%$ ($C \geq 1.0\mu\text{F}$, 16V) $DF \geq 12.5\%$ (10V) 														
4.	Dielectric strength	<ul style="list-style-type: none"> To apply voltage ($< 50\text{V}$) : 250% of rated voltage for 1~5 sec. Charge & discharge current less than 50mA. 	No evidence of damage or flash over during test.														
		<table border="1"> <tr> <td>100V</td> <td>Cut off, set at 10mA</td> <td>100V</td> <td>≥ 3 times V DC</td> </tr> <tr> <td>200V ~ 300V</td> <td>TEST=15</td> <td>200V ~ 300V</td> <td>≥ 2 times V DC</td> </tr> <tr> <td>500V ~ 999V</td> <td>RAMP=0</td> <td>500V ~ 999V</td> <td>≥ 1.5 times V DC</td> </tr> <tr> <td>1000V ~ 3000V</td> <td></td> <td>1000V ~ 3000V</td> <td>≥ 1.2 times V DC</td> </tr> </table>	100V	Cut off, set at 10mA	100V	≥ 3 times V DC	200V ~ 300V	TEST=15	200V ~ 300V	≥ 2 times V DC	500V ~ 999V	RAMP=0	500V ~ 999V	≥ 1.5 times V DC	1000V ~ 3000V		1000V ~ 3000V
100V	Cut off, set at 10mA	100V	≥ 3 times V DC														
200V ~ 300V	TEST=15	200V ~ 300V	≥ 2 times V DC														
500V ~ 999V	RAMP=0	500V ~ 999V	≥ 1.5 times V DC														
1000V ~ 3000V		1000V ~ 3000V	≥ 1.2 times V DC														
5.	Insulation resistance	To apply rated voltage for max. 120sec.	10G Ω MIN. or 500 Ω -F MIN, whichever is smaller.														
		Rated Voltage: 100V ~ 500V	To apply rated voltage >10G Ω														
		Rated Voltage: >500V	To apply 500*60sec >10G Ω														
6.	Temperature coefficient	With no electrical load $-25^\circ\text{C} \sim 85^\circ\text{C}$ at 20°C	Within +30% / -80%														
7.	Bending test	<ul style="list-style-type: none"> The middle part of substrate shall be pressurized by means of the pressurizing rod at a rate of about 1 mm per second until the deflection becomes 1 mm and then the pressure shall be maintained for 5 sec. (Appendix 1) Measurement to be made after keeping at room temp. for 48\pm4hours 	<ul style="list-style-type: none"> No remarkable damage. Cap change : $\leq \pm 30\%$ <p>This capacitance change means the change of Capacitance under specified flexure of substrate from the capacitance measured before the test.</p>														
8.	Solderability	<ul style="list-style-type: none"> Solder temperature : $230 \pm 5^\circ\text{C}$ Dipping time : 2 ± 0.5 sec Solder : SN63A 	90%MIN. coverage of all metalized area.														

NO.	Test Items	Test Condition	Requirements
9.	Resistance to soldering heat	<ul style="list-style-type: none"> Solder temperature : 260±5°C Dipping time : 10±1 sec Solder : SN63A Measurement to be made after keeping at room temp. for 48±4 hours. 	<ul style="list-style-type: none"> No remarkable damage. Cap change : <±20% D.F value & I.R. : To meet initial standard value. Dielectric strength : no defect. 25% max. leaching on each edge.
10.	Temperature cycle	<ul style="list-style-type: none"> Test temp. : -55°C ~ 125°C Test step : <ol style="list-style-type: none"> -55°C -3/+0 °C 30±3 min. room temp. 2~3 min. 125°C +3/-0 °C 30±2 min. room temp. 2~3min. Conduct the five cycles according to the temperatures and time. Measurement to be made after keeping at room temp. for 48 ±4 hours. 	<ul style="list-style-type: none"> No remarkable damage. Cap change : <±20% D.F value & I.R. : To meet initial standard value.
11	Humidity (Damp Heat) Steady State	<ul style="list-style-type: none"> Test temp. : 40±2°C Humidity : 90~95% RH Test time : 1000+24/-0 hrs. Measurement to be made after keeping at room temp. for 48±4 hrs. 	<ul style="list-style-type: none"> No remarkable damage. Cap change : <±30% DF value : <ul style="list-style-type: none"> ≤7.5% Rated voltage: ≥50V ≤7.5% Rated voltage:25V [Except 0603≥0.068μF; 0805≥0.33μF, 1206≥1μF, DF≤10%] DF≤10.0% (C<1.0μF, 16V) [Except 0402≥0.1μF, DF≤12.5%] DF≤12.5% (C≥1.0μF, 16V) DF≤15% (10V) I.R. : 1GΩ MIN or 50Ω-F MIN ,whichever is smaller
12.	Humidity (Damp Heat) Load	<ul style="list-style-type: none"> Test temp. : 40±2°C Humidity : 90~95% RH Test time : 1000+24/-0 hrs. To apply voltage : rated voltage (Max. 500V) Measurement to be made after keeping at room temp. for 48±4 hrs. 	<ul style="list-style-type: none"> No remarkable damage. Cap change : <±30% DF value : <ul style="list-style-type: none"> ≤7.5% Rated voltage: ≥50V ≤7.5% Rated voltage:25V [Except 0603≥0.1μF; 0805≥0.33μF, 1206≥1μF, DF≤10%] DF≤10.0% (C<1.0μF · 16V) [Except 0402≥0.068μF, DF≤12.5%] DF≤12.5% (C≥1.0μF · 16V) DF≤15% (10V) I.R. : 500MΩ MIN. or 25Ω-F MIN.,whichever is smaller.
13.	Adhesive strength of termination	<ul style="list-style-type: none"> Pressurizing force : 1kg (10N) Test time:10±1sec (Appendix2) 	No remarkable damage or removal of the terminations.

NO.	Test Items	Test Condition	Requirements
14	Vibration Resistance	<ul style="list-style-type: none"> Vibration frequency : 10~55 Hz/min. Total amplitude : 1.5mm Test time : 6 hrs.(Two hours each in three mutually perpendicular directions.) 	<ul style="list-style-type: none"> No remarkable damage. Cap change & DF : To meet initial requirements
15.	High Temperature Load (Endurance)	<ul style="list-style-type: none"> Test temp. : 85±3°C To apply voltage : V<500V : 200% of rated voltage. V≥500V, <1000V : 150% of rated voltage. V≥1000V : 120% of rated voltage.(Max.3600V) Test time : 1000+24/-0 hrs. Measurement to be made after keeping at room temp. for 48±4 hours. 	<ul style="list-style-type: none"> No remarkable damage. Cap change : <±30% DF value : ≤7.5% Rated voltage: ≥50V ≤7.5% Rated voltage:25V [Except 0603≥0.1μF; 0805≥0.33μF, 1206≥1μF, DF≤10%] DF≤10.0% (C<1.0μF · 16V) [Except 0402≥0.068μF, DF≤12.5%] DF≤12.5% (C≥1.0μF, 16V) DF≤15% (10V) I.R. : 1GΩ MIN. or 50Ω-F MIN., whichever is smaller.

TOLERANCE AND CAPACITANCE

Capacitance & Tolerance	NPO	X7R	Y5V
1R0=1.0pF 100=10pF 101=100pF 102=1000pF=1nF 103=10000pF=10nF 104=100nF 105=1000nF=1μF 106=10000nF=10 μF	0R5-104	101-105	103-226
B: ±0.1pF (Cap ≤ 5pF) C: ±0.25pF (Cap ≤ 5pF) D: ±0.5pF (5pF < Cap < 10pF) F: ±1% G: ±2% J: ±5% K: ±10% M: ±20% Z : -20% / +80%	B, C, D, F, G, J, K	J, K, M	M, Z

LENGTH, WIDTH, AND MB

Unit: inch(mm)

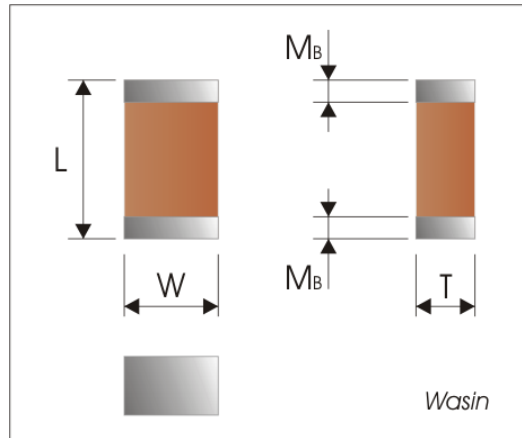

size	0402	0603	0805	1206	1210	1808	1812
Length	0.040±0.0002 (1.00±0.05)	0.063±0.004 (1.60±0.10)	0.080±0.006 (2.00±0.15)	0.125±0.006 (3.20±0.15)	0.125±0.012 (3.20±0.30)	0.180±0.015 (4.50±0.40)	0.180±0.012 (4.50±0.30)
Width	0.020±0.002 (0.50±0.05)	0.030±0.003 (0.80±0.07)	0.050±0.004 (1.25±0.1)	0.063±0.006 (1.60±0.15) 0.063±0.008 (1.60±0.2) <<Note>>	0.100±0.008 (2.50±0.20)	0.081±0.010 (2.03±0.25)	0.125±0.012 (3.20±0.30)
MB	0.010+0.002/-0.004 (0.25+0.05/-0.10)	0.015±0.006 (0.40±0.15)	0.020±0.008 (0.50±0.20)	0.025±0.008 (0.60±0.20)	0.030±0.010 (0.75±0.25)	0.030±0.010 (0.75±0.25)	0.030±0.010 (0.75±0.25)

Note : Width 1.60±0.2mm is applied to thickness G(=1.6±0.2mm), and width 1.60±0.15mm is applied to the others.



CAPACITANCE AND VOLTAGE (NPO)

DIELECTRIC		NPO																											
SIZE	EIA CAP	0402				0603				0805				1206				1210				1812							
VDCW	CODE	10V	16V	25V	50V	10V	16V	25V	50V	10V	16V	25V	50V	10V	16V	25V	50V	10V	16V	25V	50V	10V	16V	25V	50V	10V	16V	25V	50V
0.5pF	0R5	N	N	N	N	S	S	S	S	A	A	A	A																
1	1R0	N	N	N	N	S	S	S	S	A	A	A	A																
1.2	1R2	N	N	N	N	S	S	S	S	A	A	A	A																
1.5	1R5	N	N	N	N	S	S	S	S	A	A	A	A	B	B	B	B												
1.8	1R8	N	N	N	N	S	S	S	S	A	A	A	A	B	B	B	B												
2.2	2R2	N	N	N	N	S	S	S	S	A	A	A	A	B	B	B	B												
2.7	2R7	N	N	N	N	S	S	S	S	A	A	A	A	B	B	B	B												
3.3	3R3	N	N	N	N	S	S	S	S	A	A	A	A	B	B	B	B												
3.9	3R9	N	N	N	N	S	S	S	S	A	A	A	A	B	B	B	B												
4.7	4R7	N	N	N	N	S	S	S	S	A	A	A	A	B	B	B	B												
5.6	5R6	N	N	N	N	S	S	S	S	A	A	A	A	B	B	B	B												
6.8	6R8	N	N	N	N	S	S	S	S	A	A	A	A	B	B	B	B												
8.2	8R2	N	N	N	N	S	S	S	S	A	A	A	A	B	B	B	B												
10pF	100	N	N	N	N	S	S	S	S	A	A	A	A	B	B	B	B												
12	120	N	N	N	N	S	S	S	S	A	A	A	A	B	B	B	B												
15	150	N	N	N	N	S	S	S	S	A	A	A	A	B	B	B	B												
18	180	N	N	N	N	S	S	S	S	A	A	A	A	B	B	B	B												
22	220	N	N	N	N	S	S	S	S	A	A	A	A	B	B	B	B	C	C	C	C								
27	270	N	N	N	N	S	S	S	S	A	A	A	A	B	B	B	B	C	C	C	C								
33	330	N	N	N	N	S	S	S	S	A	A	A	A	B	B	B	B	C	C	C	C								
39	390	N	N	N	N	S	S	S	S	A	A	A	A	B	B	B	B	C	C	C	C								
47	470	N	N	N	N	S	S	S	S	A	A	A	A	B	B	B	B	C	C	C	C								
56	560	N	N	N	N	S	S	S	S	A	A	A	A	B	B	B	B	C	C	C	C								
68	680	N	N	N	N	S	S	S	S	A	A	A	A	B	B	B	B	C	C	C	C								
82	820	N	N	N	N	S	S	S	S	A	A	A	A	B	B	B	B	C	C	C	C								
100pF	101	N	N	N	N	S	S	S	S	A	A	A	A	B	B	B	B	C	C	C	C								
120	121	N	N	N	N	S	S	S	S	A	A	A	A	B	B	B	B	C	C	C	C								
150	151	N	N	N	N	S	S	S	S	A	A	A	A	B	B	B	B	C	C	C	C								
180	181	N	N	N	N	S	S	S	S	A	A	A	A	B	B	B	B	C	C	C	C								
220	221	N	N	N	N	S	S	S	S	A	A	A	A	B	B	B	B	C	C	C	C								
270	271	N	N			S	S	S	S	A	A	A	A	B	B	B	B	C	C	C	C								
330	331	N	N			S	S	S	S	A	A	A	A	B	B	B	B	C	C	C	C								
390	391	N	N			S	S	S	S	B	B	B	B	B	B	B	B	C	C	C	C								
470	471	N	N			S	S	S	S	B	B	B	B	B	B	B	B	C	C	C	C								
560	561					S	S	S	S	B	B	B	B	B	B	B	B	C	C	C	C								
680	681					S	S	S	S	B	B	B	B	B	B	B	B	C	C	C	C								
820	821					S	S	S	S	B	B	B	B	B	B	B	B	C	C	C	C								
1000pF	102					S	S	S	S	B	B	B	B	B	B	B	B	C	C	C	C	D	D	D	D				
1200	122					S	S			B	B	B	B	B	B	B	B	C	C	C	C	D	D	D	D				
1500	152					S	S			B	B	B	B	B	B	B	B	C	C	C	C	D	D	D	D				
1800	182					S	S			B	B	B	B	B	B	B	B	C	C	C	C	D	D	D	D				
2200	222					S	S			B	B	B	B	B	B	B	B	C	C	C	C	D	D	D	D				
2700	272					S	S			D	D	D	D	B	B	B	B	C	C	C	C	D	D	D	D				
3300	332					S	S			D	D	D	D	B	B	B	B	C	C	C	C	D	D	D	D				
3900	392									D	D	D	D	B	B	B	B	C	C	C	C	D	D	D	D				
4700	472									D	D	D		B	B	B	B	C	C	C	C	D	D	D	D				
5600	562									D	D			B	B	B	B	C	C	C	C	D	D	D	D				
6800	682									D	D			C	C	C	C	C	C	C	C	D	D	D	D				
8200	822									D	D			C	C	C	C	C	C	C	C	D	D	D	D				
0.01μF	103									D	D			D	D	D	D	C	C	C	C	D	D	D	D				
0.012	123									D	D			D	D			C	C	D	D	D	D	D	D				
0.015	153													D	D			C	C	D	D	D	D	D	D				
0.018	183													D	D			C	C			D	D	D	D				
0.022	223													D	D			C	C			D	D	D	D				
0.027	273													D	D			C	C			D	D	D	D				
0.033	333													D	D			C	C			D	D	D	D				
0.039	393													G	G			C	C			D	D						
0.047	473																	D	D			D	D						
0.056	563																	D	D			D	D						
0.068	683																					D	D						
0.082	823																					D	D						
0.1μF	104																					D	D						

(1) OTHER SIZE , CAPACITANCE , VOLTAGE , AND 13" REEL ARE AVAILABLE UPON CUSTOMER'S REQUEST.

TAPE AND REEL: Size Unit : inch(mm)

SIZE	0402(1005)	0603(1608)	0805(2012)	1206(3216)	1210(3225)	1808(4520)	1812(4532)
A=0.6±0.1mm	—	—	PAPER 4Kp/REEL	—	—	—	—
B=0.8±0.1mm	—	—	PAPER 4Kp/REEL	PAPER 4Kp/REEL	—	—	—
C=0.95±0.1mm	—	—	—	PLASTIC 3Kp/REEL	PLASTIC 3Kp/REEL	—	—
D=1.25±0.1mm	—	—	PLASTIC 3Kp/REEL	PLASTIC 3Kp/REEL	PLASTIC 3Kp/REEL	PLASTIC 2Kp/REEL	PLASTIC 1Kp/REEL
G=1.60±0.2mm	—	—	—	PLASTIC 2Kp/REEL	—	—	—
S=0.8±0.07mm	—	PAPER 4Kp/REEL	—	—	—	—	—
N=0.50±0.05mm	PAPER 10Kp/REEL	—	—	—	—	—	—
K=2.00±0.2mm	—	—	—	—	—	PLASTIC 1Kp/REEL	PLASTIC 1Kp/REEL
M=2.5±0.30mm	—	—	—	—	—	—	—



CAPACITANCE AND VOLTAGE (Hi-Voltage NPO)

DIELECTRIC		NPO																											
SIZE	EIA CAP	0603					0805					1206					1210					1808			1812				
VDCW	CODE	100	100	200	250	500	100	200	250	500	1000	2000	100	200	250	500	1000	2000	1000	2000	3000	100	200	250	500	1000	2000	3000	
0.5pF	0R5	S	A	A	A	A																							
1	1R0	S	A	A	A	A																							
1.2	1R2	S	A	A	A	A																							
1.5	1R5	S	A	A	A	A	B	B	B	B	B	B																	
1.8	1R8	S	A	A	A	A	B	B	B	B	B	B																	
2.2	2R2	S	A	A	A	A	B	B	B	B	B	B																	
2.7	2R7	S	A	A	A	A	B	B	B	B	B	B																	
3.3	3R3	S	A	A	A	A	B	B	B	B	B	B																	
3.9	3R9	S	A	A	A	A	B	B	B	B	B	B																	
4.7	4R7	S	A	A	A	A	B	B	B	B	B	B																	
5.6	5R6	S	A	A	A	A	B	B	B	B	B	B																	
6.8	6R8	S	A	A	A	A	B	B	B	B	B	B																	
8.2	8R2	S	A	A	A	A	B	B	B	B	B	B																	
10pF	100	S	A	A	A	A	B	B	B	B	B	B	C	C	C	C	C	C	D	D	D	D	D	D	D	D	D	D	
12	120	S	A	A	A	A	B	B	B	B	B	B	C	C	C	C	C	C	D	D	D	D	D	D	D	D	D	D	
15	150	S	A	A	A	A	B	B	B	B	B	B	C	C	C	C	C	C	D	D	D	D	D	D	D	D	D	D	
18	180	S	A	A	A	A	B	B	B	B	B	B	C	C	C	C	C	C	D	D	D	D	D	D	D	D	D	D	
22	220	S	A	A	A	A	B	B	B	B	B	B	C	C	C	C	C	C	D	D	D	D	D	D	D	D	D	D	
27	270	S	A	A	A	A	B	B	B	B	B	B	C	C	C	C	C	C	D	D	D	D	D	D	D	D	D	D	
33	330	S	A	A	A	A	B	B	B	B	B	B	C	C	C	C	C	C	D	D	D	D	D	D	D	D	D	D	
39	390	S	A	A	A	A	B	B	B	B	B	B	C	C	C	C	C	C	D	D	D	D	D	D	D	D	D	D	
47	470	S	A	A	A	A	B	B	B	B	B	B	C	C	C	C	C	C	D	D	D	D	D	D	D	D	D	D	
56	560	S	A	A	A	A	B	B	B	B	B	B	C	C	C	C	C	C	D	D	D	D	D	D	D	D	D	D	
68	680	S	A	A	A	A	B	B	B	B	B	B	C	C	C	C	C	C	D	D	D	D	D	D	D	D	D	D	
82	820	S	A	A	A	B	B	B	B	B	B	B	C	C	C	C	C	C	D	D	D	D	D	D	D	D	D	D	
100pF	101	S	A	A	A	B	B	B	B	B	B	B	C	C	C	C	C	C	D	D	D	D	D	D	D	D	D	D	
120	121	S	A	A	A	D	B	B	B	B	B	B	C	C	C	C	C	C	D	D	D	D	D	D	D	D	D	D	
150	151	S	A	B	B	D	B	B	B	B	B	B	C	D	C	C	C	C	D	D	D	D	D	D	D	D	D	D	
180	181	S	A	B	B	D	B	B	B	B	B	B	C	G	C	C	C	C	D	D	D	K	D	D	D	D	D	D	
220	221	S	A	D	D	D	B	B	B	B	B	B	D	G	C	C	C	C	D	D	D	K	D	D	D	D	D	D	
270	271	S	A	D	D	D	B	B	B	B	B	B	C	D	C	C	C	C	D	D	D	K	D	D	D	D	D	D	
330	331	S	A	D	D	D	B	B	B	B	B	B	C		C	C	C	C	D	D	D		D	D	D	D	D	D	
390	391	S	B	D	D	D	B	B	B	B	B	B	C		C	C	C	C	D	D	D		D	D	D	D	D	D	
470	471	S	B	D			B	C	C	C	C	C	C		C	C	C	C	D	D	D		D	D	D	D	D	D	
560	561	S	B	D			B	C	C	C	C	C	C		C	C	C	C	D	D	D		D	D	D	D	D	D	
680	681		B	D			B	C	C	C	C	C		C	C	C	C	D	D	D		D	D	D	D	D	D		
820	821		B	D			B	C	D	D	D	C		C	C	C	C	D	D	D		D	D	D	D	D	D		
1000pF	102		B				B	C				C		C	C	C	C	D	D	D		D	D	D	D	D	D		
1200	122		B				B	C				C		D	D	D	D	D	D	D		D	D	D	D	D	D		
1500	152		B				B	C				C		D	D	D	D	D	D	D		D	D	D	D	D	D		
1800	182		B				B	D				C		D	D	D	D	D	D	D		D	D	D	D	D	D		
2200	222		B				B	D				C		D	D	D	D	D	D	D		D	D	D	D	D	D		
2700	272		D				B					C		D	D	D	D	D	D	D		D	D	D	D	D	D		
3300	332		D				B					C		D				D	D	D		D	D	D	D	D	D		
3900	392		D				B					C		D				D	D	D		D	D	D	D	D	D		
4700	472						B					C						D	D	D		D	D	D	D	D	D		
5600	562						B					C						D	D	D		D	D	D	D	D	D		
6800	682						C					C						D	D	D		D	D	D	D	D	D		
8200	822						C					C						D	D	D		D	D	D	D	D	D		
0.01μF	103											C						D	D	D		D	D	D	D	D	D		
0.012	123											D						D	D	D		D	D	D	D	D	D		
0.015	153											D						D	D	D		D	D	D	D	D	D		
0.018	183											D						D	D	D		D	D	D	D	D	D		
0.022	223																	D	D	D		D	D	D	D	D	D		
0.027	273																	D	D	D		D	D	D	D	D	D		
0.033μF	333																	D	D	D		D	D	D	D	D	D		

(1) OTHER SIZE, CAPACITANCE, VOLTAGE, AND 13" REEL ARE AVAILABLE UPON CUSTOMER'S REQUEST.

TAPE AND REEL: Size Unit : inch(mm)

SIZE	0402(1005)	0603(1608)	0805(2012)	1206(3216)	1210(3225)	1808(4520)	1812(4532)
A=0.6+/-0.1mm	—	—	PAPER 4Kp/REEL	—	—	—	—
B=0.8+/-0.1mm	—	—	PAPER 4Kp/REEL	PAPER 4Kp/REEL	—	—	—
C=0.95+/-0.1mm	—	—	—	PLASTIC 3Kp/REEL	PLASTIC 3Kp/REEL	—	—
D=1.25±0.1mm	—	—	PLASTIC 3Kp/REEL	PLASTIC 3Kp/REEL	PLASTIC 3Kp/REEL	PLASTIC 2Kp/REEL	PLASTIC 1Kp/REEL
G=1.60+/-0.2mm	—	—	—	PLASTIC 2Kp/REEL	—	—	—
S=0.8±0.07mm	—	PAPER 4Kp/REEL	—	—	—	—	—
N=0.50±0.05mm	PAPER 10Kp/REEL	—	—	—	—	—	—
K=2.00±0.2mm	—	—	—	—	—	PLASTIC 1Kp/REEL	PLASTIC 1Kp/REEL
M=2.5±0.30mm	—	—	—	—	—	—	—



CAPACITANCE AND VOLTAGE (X7R BME)

DIELECTRIC		X7R																							
SIZE	EIA CAP	0402				0603				0805				1206				1210				1812			
VDCW	CODE	10V	16V	25V	50V	10V	16V	25V	50V	10V	16V	25V	50V	10V	16V	25V	50V	10V	16V	25V	50V	10V	16V	25V	50V
100pF	101	N	N	N	N	S	S	S	S	B	B	B	B												
120	121	N	N	N	N	S	S	S	S	B	B	B	B												
150	151	N	N	N	N	S	S	S	S	B	B	B	B	B [^]	B [^]	B [^]	B [^]								
180	181	N	N	N	N	S	S	S	S	B	B	B	B	B [^]	B [^]	B [^]	B [^]								
220	221	N	N	N	N	S	S	S	S	B	B	B	B	B [^]	B [^]	B [^]	B [^]								
270	271	N	N	N	N	S	S	S	S	B	B	B	B	B [^]	B [^]	B [^]	B [^]								
330	331	N	N	N	N	S	S	S	S	B	B	B	B	B [^]	B [^]	B [^]	B [^]								
390	391	N	N	N	N	S	S	S	S	B	B	B	B	B [^]	B [^]	B [^]	B [^]								
470	471	N	N	N	N	S	S	S	S	B	B	B	B	B [^]	B [^]	B [^]	B [^]								
560	561	N	N	N	N	S	S	S	S	B	B	B	B	B [^]	B [^]	B [^]	B [^]								
680	681	N	N	N	N	S	S	S	S	B	B	B	B	B [^]	B [^]	B [^]	B [^]								
820	821	N	N	N	N	S	S	S	S	B	B	B	B	B	B	B	B								
1000pF	102	N	N	N	N	S	S	S	S	B	B	B	B	B	B	B	B	C [^]	C [^]	C [^]	C [^]	D [^]	D [^]	D [^]	D [^]
1200	122	N	N	N	N	S	S	S	S	B	B	B	B	B	B	B	B	C [^]	C [^]	C [^]	C [^]	D [^]	D [^]	D [^]	D [^]
1500	152	N	N	N	N	S	S	S	S	B	B	B	B	B	B	B	B	C [^]	C [^]	C [^]	C [^]	D [^]	D [^]	D [^]	D [^]
1800	182	N	N	N	N	S	S	S	S	B	B	B	B	B	B	B	B	C [^]	C [^]	C [^]	C [^]	D [^]	D [^]	D [^]	D [^]
2200	222	N	N	N	N	S	S	S	S	B	B	B	B	B	B	B	B	C [^]	C [^]	C [^]	C [^]	D [^]	D [^]	D [^]	D [^]
2700	272	N	N	N	N	S	S	S	S	B	B	B	B	B	B	B	B	C [^]	C [^]	C [^]	C [^]	D [^]	D [^]	D [^]	D [^]
3300	332	N	N	N	N	S	S	S	S	B	B	B	B	B	B	B	B	C [^]	C [^]	C [^]	C [^]	D [^]	D [^]	D [^]	D [^]
3900	392	N	N	N	N	S	S	S	S	B	B	B	B	B	B	B	B	C [^]	C [^]	C [^]	C [^]	D [^]	D [^]	D [^]	D [^]
4700	472	N	N	N	N	S	S	S	S	B	B	B	B	B	B	B	B	C [^]	C [^]	C [^]	C [^]	D [^]	D [^]	D [^]	D [^]
5600	562	N	N	N		S	S	S	S	B	B	B	B	B	B	B	B	C [^]	C [^]	C [^]	C [^]	D [^]	D [^]	D [^]	D [^]
6800	682	N	N	N		S	S	S	S	B	B	B	B	B	B	B	B	C [^]	C [^]	C [^]	C [^]	D [^]	D [^]	D [^]	D [^]
8200	822	N	N	N		S	S	S	S	B	B	B	B	B	B	B	B	C	C	C	C	D [^]	D [^]	D [^]	D [^]
0.01μF	103	N	N	N		S	S	S	S	B	B	B	B	B	B	B	B	C	C	C	C	D [^]	D [^]	D [^]	D [^]
0.012	123	N	N			S	S	S	S	B	B	B	B	B	B	B	B	C	C	C	C	D [^]	D [^]	D [^]	D [^]
0.015	153	N	N			S	S	S	S	B	B	B	B	B	B	B	B	C	C	C	C	D [^]	D [^]	D [^]	D [^]
0.018	183	N	N			S	S	S	S	B	B	B	B	B	B	B	B	C	C	C	C	D [^]	D [^]	D [^]	D [^]
0.022	223	N	N			S	S	S	S	B	B	B	B	B	B	B	B	C	C	C	C	D [^]	D [^]	D [^]	D [^]
0.027	273	N				S	S	S	S	B	B	B	B	B	B	B	B	C	C	C	C	D [^]	D [^]	D [^]	D [^]
0.033	333	N				S	S	S		B	B	B	B	B	B	B	B	C	C	C	C	D [^]	D [^]	D [^]	D [^]
0.039	393	N				S	S	S		B	B	B	B	B	B	B	B	C	C	C	C	D [^]	D [^]	D [^]	D [^]
0.047	473	N				S	S	S		B	B	B	B	B	B	B	B	C	C	C	C	D [^]	D [^]	D [^]	D [^]
0.056	563					S	S	S		B	B	B	B	B	B	B	B	C	C	C	C	D [^]	D [^]	D [^]	D [^]
0.068	683					S	S	S		B	B	B	B	B	B	B	B	C	C	C	C	D [^]	D [^]	D [^]	D [^]
0.082	823					S	S			B	B	B	D	B	B	B	B	C	C	C	C	D	D	D	D
0.1μF	104					S	S			B	B	B	D	B	B	B	B	C	C	C	C	D	D	D	D
0.12	124					S				B	B	B	D	B	B	B	B	C	C	C	C	D	D	D	D
0.15	154					S				D	D	D	D	C	C	C	C	C	C	C	C	D	D	D	D
0.18	184					S				D	D	D		C	C	C	C	C	C	C	C	D	D	D	D
0.22	224					S				D	D	D		C	C	C	C	C	C	C	C	D	D	D	D
0.27	274									D	D	D		C	C	C		C	C	C	C	D	D	D	D
0.33	334									D	D	D		C	C	C		C	C	C	D	D	D	D	D
0.39	394									D	D			C	C			C	C	C	D	D	D	D	D
0.47	474									D	D			D	D			C	C	C		D	D	D	D
0.56	564									D	D			D	D							D	D	D	D
0.68	684									D				D	D							D	D	D	K
0.82	824									D				D	D							D	D	D	K
1μF	105									D				D	D							D	D	D	K

(1) OTHER SIZE , CAPACITANCE , VOLTAGE , AND 13" REEL ARE AVAILABLE UPON CUSTOMER'S REQUEST.

(2) [^] : the said items are made by NME(Noble Metal Electrode).

TAPE AND REEL: Size Unit : inch(mm)

SIZE	0402(1005)	0603(1608)	0805(2012)	1206(3216)	1210(3225)	1808(4520)	1812(4532)
A=0.6+/-0.1mm	—	—	PAPER 4Kp/REEL	—	—	—	—
B=0.8+/-0.1mm	—	—	PAPER 4Kp/REEL	PAPER 4Kp/REEL	—	—	—
C=0.95+/-0.1mm	—	—	—	PLASTIC 3Kp/REEL	PLASTIC 3Kp/REEL	—	—
D=1.25±0.1mm	—	—	PLASTIC 3Kp/REEL	PLASTIC 3Kp/REEL	PLASTIC 3Kp/REEL	PLASTIC 2Kp/REEL	PLASTIC 1Kp/REEL
G=1.60+/-0.2mm	—	—	—	PLASTIC 2Kp/REEL	—	—	—
S=0.8±0.07mm	—	PAPER 4Kp/REEL	—	—	—	—	—
N=0.50±0.05mm	PAPER 10Kp/REEL	—	—	—	—	—	—
K=2.00±0.2mm	—	—	—	—	—	PLASTIC 1Kp/REEL	PLASTIC 1Kp/REEL
M=2.5±0.30mm	—	—	—	—	—	—	—



CAPACITANCE AND VOLTAGE (Y5V BME)

DIELECTRIC		Y5V																								
SIZE	EIA CAP	0402				0603				0805				1206				1210				1812				
VDCW	CODE	10V	16V	25V	50V	10V	16V	25V	50V	10V	16V	25V	50V	10V	16V	25V	50V	10V	16V	25V	50V	10V	16V	25V	50V	
1000pF	102																									
1200	122																									
1500	152																									
1800	182																									
2200	222																									
2700	272																									
3300	332																									
3900	392																									
4700	472																									
5600	562																									
6800	682																									
8200	822																									
0.01μF	103	N	N	N	N	S	S	S	S	A	A	A	A	B	B	B	B									
0.012	123	N	N	N	N	S	S	S	S	A	A	A	A	B	B	B	B									
0.015	153	N	N	N	N	S	S	S	S	A	A	A	A	B	B	B	B									
0.018	183	N	N	N	N	S	S	S	S	A	A	A	A	B	B	B	B									
0.022	223	N	N	N	N	S	S	S	S	A	A	A	A	B	B	B	B									
0.027	273	N	N	N	N	S	S	S	S	A	A	A	A	B	B	B	B									
0.033	333	N	N	N	N	S	S	S	S	A	A	A	A	B	B	B	B									
0.039	393	N	N	N	N	S	S	S	S	A	A	A	A	B	B	B	B									
0.047	473	N	N	N	N	S	S	S	S	A	A	A	A	B	B	B	B									
0.056	563	N	N	N	N	S	S	S	S	A	A	A	A	B	B	B	B									
0.068	683	N	N	N	N	S	S	S	S	A	A	A	A	B	B	B	B									
0.082	823	N	N	N	N	S	S	S	S	A	A	A	A	B	B	B	B									
0.1μF	104	N	N	N	N	S	S	S	S	A	A	A	A	B	B	B	B	C	C	C	C	D	D	D	D	D
0.15	154	N	N	N	N	S	S	S	S	A	A	A	A	B	B	B	B	C	C	C	C	D	D	D	D	D
0.22	224	N	N	N	N	S	S	S	S	A	A	A	A	B	B	B	B	C	C	C	C	D	D	D	D	D
0.33	334	N	N	N	N	S	S	S	S	B	B	B	B	B	B	B	B	C	C	C	C	D	D	D	D	D
0.47	474	N	N	N	N	S	S	S	S	B	B	B	B	B	B	B	B	C	C	C	C	D	D	D	D	D
0.68	684	N	N	N	N	S	S	S	S	B	B	D	D	B	B	B	B	C	C	C	C	D	D	D	D	D
1μF	105	N	N	N	N	S	S	S	S	B	B	D	D	C	C	C	C	C	C	C	C	D	D	D	D	D
1.5	155	N	N	N	N	S	S	S	S	D	D	D	D	C	C	C	C	C	C	C	C	D	D	D	D	D
2.2	225	N	N	N	N	S	S	S	S	D	D	D	D	C	C	C	C	C	C	C	C	D	D	D	D	D
3.3	335	N	N	N	N	S	S	S	S	D	D	D	D	D	D	D	D	C	C	C	C	D	D	D	D	D
4.7	475	N	N	N	N	S	S	S	S	D	D	D	D	D	D	D	D	C	C	C	D	D	D	D	D	D
6.8	685	N	N	N	N	S	S	S	S	D	D	D	D	D	D	D	D	C	C	C	C	D	D	D	D	D
10μF	106	N	N	N	N	S	S	S	S	D	D	D	D	D	D	D	D	D	D	D	D	D	D	D	D	D
22μF	226	N	N	N	N	S	S	S	S	D	D	D	D	D	D	D	D	D	D	D	D	D	D	D	D	D

(1) OTHER SIZE , CAPACITANCE , VOLTAGE , AND 13" REEL ARE AVAILABLE UPON CUSTOMER'S REQUEST.

TAPE AND REEL: Size Unit : inch(mm)

SIZE	0402(1005)	0603(1608)	0805(2012)	1206(3216)	1210(3225)	1808(4520)	1812(4532)
A=0.6±0.1mm	—	—	PAPER 4Kp/REEL	—	—	—	—
B=0.8±0.1mm	—	—	PAPER 4Kp/REEL	PAPER 4Kp/REEL	—	—	—
C=0.95±0.1mm	—	—	—	PLASTIC 3Kp/REEL	PLASTIC 3Kp/REEL	—	—
D=1.25±0.1mm	—	—	PLASTIC 3Kp/REEL	PLASTIC 3Kp/REEL	PLASTIC 3Kp/REEL	PLASTIC 2Kp/REEL	PLASTIC 1Kp/REEL
G=1.60±0.2mm	—	—	—	PLASTIC 2Kp/REEL	—	—	—
S=0.8±0.07mm	—	PAPER 4Kp/REEL	—	—	—	—	—
N=0.50±0.05mm	PAPER 10Kp/REEL	—	—	—	—	—	—
K=2.00±0.2mm	—	—	—	—	—	PLASTIC 1Kp/REEL	PLASTIC 1Kp/REEL
M=2.5±0.30mm	—	—	—	—	—	—	—

CAPACITANCE AND VOLTAGE (Hi-Voltage Y5V BME)

DIELECTRIC		Y5V											
SIZE	EIA CAP	0805			1206			1210			1812		
VDCW	CODE	100	200	250	100	200	250	100	200	250	100	200	250
0.01 μ F	103	B	B	B	B	B	B	C	C	C	D	D	D
0.015	153	B	B	B	B	B	B	C	C	C	D	D	D
0.022	223	B	B	B	B	B	B	C	C	C	D	D	D
0.033	333	B	B	B	B	B	B	C	C	C	D	D	D
0.047	473	B	B	B	B	B	B	C	C	C	D	D	D
0.068	683	B	B	B	B	B	B	C	C	C	D	D	D
0.1 μ F	104	B			B	B	B	C	C	C	D	D	D
0.15	154				C	C	C	C	C	C	D	D	D
0.22	224				C			C			D	D	D
0.33	334							C			D	D	D
0.47	474										D	D	D
0.68	684										D	D	D
1 μ F	105										D		

(1) OTHER SIZE , CAPACITANCE , VOLTAGE , AND 13" REEL ARE AVAILABLE UPON CUSTOMER'S REQUEST.

TAPE AND REEL: Size Unit : inch(mm)

SIZE	0805(2012)	1206(3216)	1210(3225)	1812(4532)
A=0.6+/-0.1mm	PAPER 4Kp/REEL	—	—	—
B=0.8+/-0.1mm	PAPER 4Kp/REEL	PAPER 4Kp/REEL	—	—
C=0.95+/-0.1mm	—	PLASTIC 3Kp/REEL	PLASTIC 3Kp/REEL	—
D=1.25±0.1mm	PLASTIC 3Kp/REEL	PLASTIC 3Kp/REEL	PLASTIC 3Kp/REEL	PLASTIC 1Kp/REEL
G=1.60+/-0.2mm	—	PLASTIC 2Kp/REEL	—	—
S=0.8±0.07mm	—	—	—	—
N=0.50±0.05mm	—	—	—	—
K=2.00±0.2mm	—	—	—	PLASTIC 1Kp/REEL
M=2.5±0.30mm	—	—	—	—

*** NEW PRODUCTS PROMOTION ***

(1). X5R Series,

X5R 0402 56nF- 100nF /10V

(2). Multi-layer C-array Series,

NPO 0603*4(8P4C) 10pF- 470pF /50V
 X7R 0603*4(8P4C) 100pF- 100nF /16V
 X7R 0603*4(8P4C) 100pF- 10nF /50V,25V
 Y5V 0603*4(8P4C) 10nF- 100nF /50V,25V

(3). Low Inductance Capacitor (LIC) Series,

X5R 0306 100nF- 220nF /10V
 X7R 0612 10nF- 100nF /50V

PACKING ON TAPE AND REEL

Unit per reel							Unit : mm
chip size	Paper tape			Plastic tape			* chip thickness :
	w idth(reel)	thickness	unit/reel	width(reel)	thickness	unit/reel	
0402	8 mm (7")	N	10Kp/Reel				N=0.50±0.05 A=0.60±0.10 B=0.80±0.10 C=0.95±0.10 D=1.25±0.10 S=0.80 ±0.07 G=1.60 ± 0.20 K=2.00± 0.20 M=2.5± 0.30
	8mm(13")	N	50Kp/Reel				
0603	8 mm (7")	S	4Kp/Reel				
	8mm(10")	S	10Kp/Reel				
	8mm(13")	S	15Kp/Reel				
0805	8 mm (7")	A \ B	4Kp/Reel	8 mm (7")	C \ D	3Kp/Reel	
	8mm(10")	A \ B	10Kp/Reel	8mm(10")	C \ D	5Kp/Reel	
	8mm(13")	A \ B	15Kp/Reel	8mm(13")	C \ D	10Kp/Reel	
1206	8 mm (7")	A \ B	4Kp/Reel	8 mm (7")	C \ D	3Kp/Reel	
	8mm(10")	A \ B	10Kp/Reel	8mm(10")	C \ D	5Kp/Reel	
	8mm(13")	A \ B	15Kp/Reel	8mm(13")	C \ D	10Kp/Reel	
				8 mm (7")	F \ G	2Kp/Reel	
				8 mm (7")	K	1Kp/Reel	
1210				8 mm (7")	C \ D	3Kp/Reel	
				8 mm (7")	F	1Kp/Reel	
1808				12mm (7")	C \ G	2Kp/Reel	
				12mm (7")	K	1Kp/Reel	
1812				12mm (7")	D	1Kp/Reel	

Reel size label	chip size						
	0402	0603	0805	1206	1210	1808	1812
A	13.0±1.0	13.0±1.0	13.0±1.0	13.0±1.0	13.0±1.0	13.0±1.0	13.0±1.0
B	9.0±1.0	9.0±1.0	9.0±1.0	9.0±1.0	9.0±1.0	13.5±1.0	13.5±1.0
C	178.0±1.0 (7")	178.0±1.0 (7")	178.0±1.0 (7")	178.0±1.0 (7")	178.0±1.0 (7")	178.0±1.0 (7")	178.0±1.0 (7")
		250.0±1.0 (10")	250.0±1.0 (10")	250.0±1.0 (10")			
	330.0±1.0 (13")	330.0±1.0 (13")	330.0±1.0 (13")	330.0±1.0 (13")			
D	60.5±1.0 (7")	60.5±1.0 (7")	60.5±1.0 (7")	60.5±1.0 (7")	60.5±1.0 (7")	80.0±1.0 (7")	80.0±1.0 (7")
		62.5±1.0 (10")	62.5±1.0 (10")	62.5±1.0 (10")			
	100.0±1.0 (13")	100.0±1.0 (13")	100.0±1.0 (13")	100.0±1.0 (13")			

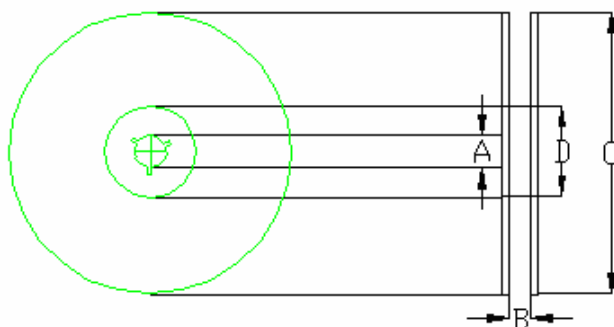

PACKING ON TAPE AND REEL

Tape Size Contrastive Table

A. Plastic tape size specification

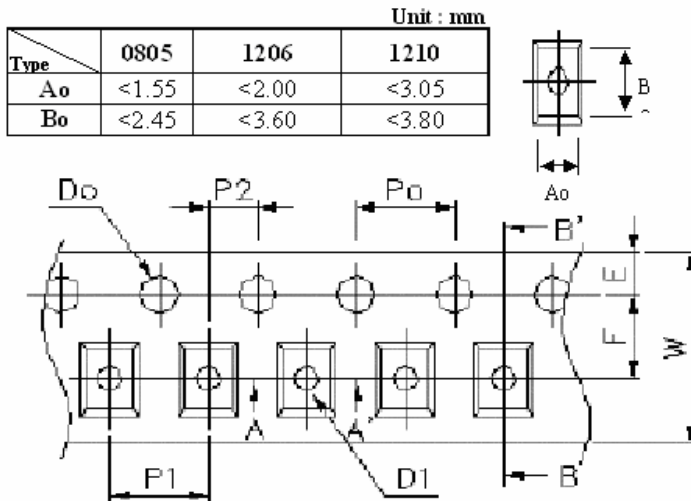

Item	Specification	Tol. (+/-)
W	8.00	±0.20
E	1.75	±0.10
F	3.50	±0.05
D0	1.50	+0.10, -0
D1	1.00	±0.10
P0	4.00	±0.05
P1	4.00	±0.10
P2	2.00	±0.05
P0 x 10	40.00	±0.20

B. Plastic tape size specification

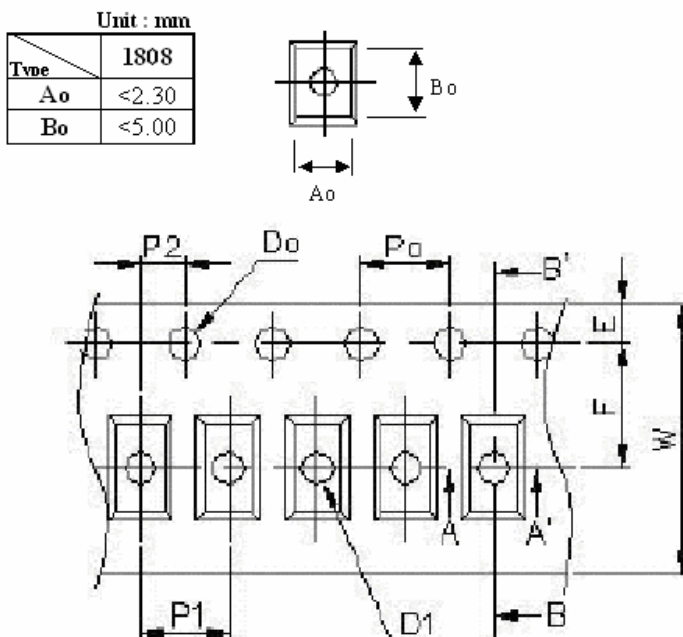

Item	Specification	Tol. (+/-)
W	12.00	±0.20
E	1.75	±0.10
F	5.50	±0.05
D0	1.50	+0.10, -0
D1	1.50	±0.10
P0	4.00	±0.05
P1	4.00	±0.10
P2	2.00	±0.05
P0 x 10	40.00	±0.20

PACKING ON TAPE AND REEL

Tape Size Contrastive Table

C. Plastic tape size specification

Unit : mm

Type	1812
A ₀	<3.80
B ₀	<5.35

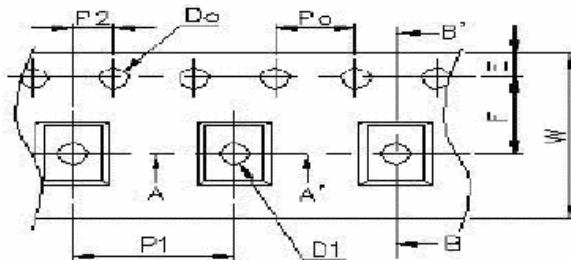
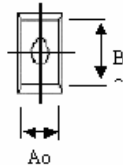

Item	Specification	Tol. (+/-)
W	12.00	±0.20
E	1.75	±0.10
F	5.50	±0.05
D0	1.50	+0.10, -0
D1	1.50	±0.10
P0	4.00	±0.05
P1	8.00	±0.10
P2	2.00	±0.05
P0 x 10	40.00	±0.20

D. Paper tape size specification

SYMBOL	PRODUCT SIZE CODE								UNIT
	0402		0603		0805		1206		
	SIZE	TOL	SIZE	TOL	SIZE	TOL	SIZE	TOL	
A ₀	0.62	±0.05	1.02	±0.05	1.50	±0.10	2.00	±0.15	mm
B ₀	1.12	±0.05	1.82	±0.05	2.30	±0.10	3.50	±0.15	mm
K ₀	0.60	±0.05	0.95	±0.05	0.95/0.75	±0.05	0.95	±0.05	mm
W	8.00	±0.10	8.00	±0.10	8.00	±0.10	8.00	±0.10	mm
D ₀	1.55	±0.05	1.55	±0.05	1.55	±0.05	1.55	±0.05	mm
E	1.75	±0.10	1.75	±0.10	1.75	±0.10	1.75	±0.10	mm
F	3.50	±0.05	3.50	±0.05	3.50	±0.05	3.50	±0.05	mm
P ₀	4.00	±0.10	4.00	±0.10	4.00	±0.10	4.00	±0.10	mm
P ₁	2.00	±0.05	4.00	±0.10	4.00	±0.10	4.00	±0.10	mm
P ₂	2.00	±0.05	2.00	±0.05	2.00	±0.05	2.00	±0.05	mm

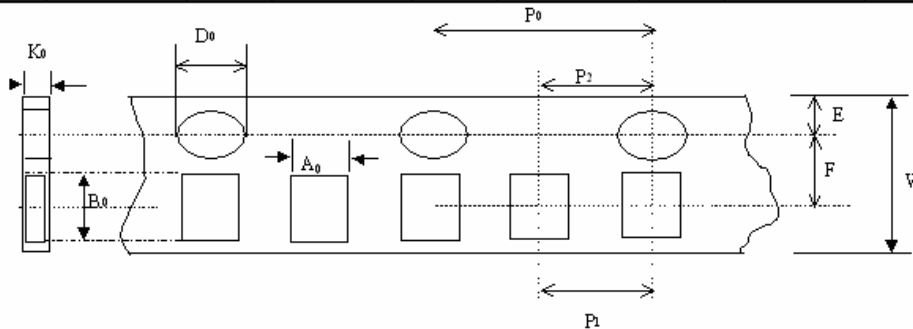

DESCRIPTION OF THE STANDARD SHIPPING LABEL

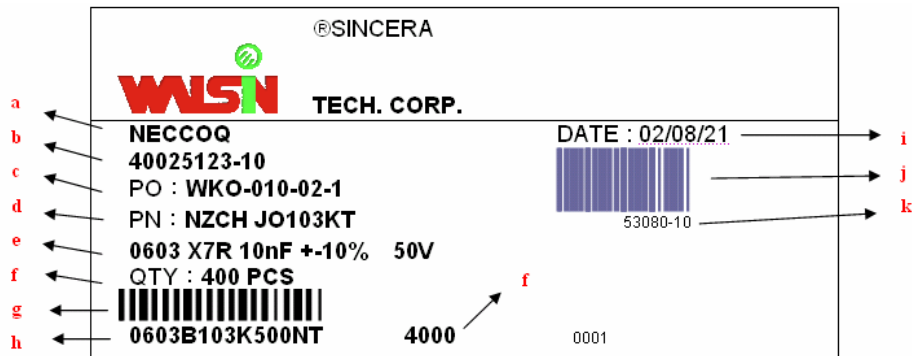

- | | |
|---|---|
| a. Customer name | g. Quantity and WALSIN P/N or customer P/N in bar code |
| b. WALSIN order serial number and item number | h. Material serial number of WALSIN |
| c. Customer P/O | i. Shipping date |
| d. Customer P/N | j. Order bar code including serial number and item number |
| e. Description of specifications | Serial number of the label |
| f. Quantity | |

Information of caution/precaution handling of chip : 1. No bumping & pressurizing when carry. 2. Keep out of water.

Walsin Standard Label (MLCC) :

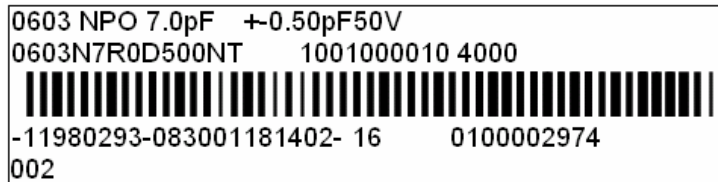

- **1st Column : 0603 NPO 7.0pF +-0.50pF50V** <<Content: product description>>
 - (1). 0603: Size (2). NPO : Dielectric (3). 7.0pF : Capacitance (4) +/-0.50pF: Tolerance
- **2nd Column : 0603N7R0D500NT 1001000010 4000** <<Content: Part number + batch number of taping +quantity per reel(pcs)>>
 - (1). 0603N7R0D500NT: Part number
 - (2). 1001000010: Batch number of taping (2.1) 000010: random number
 - (3). 4000: quantity per reel (unit: pieces)
- **3rd Column: Bar code** <<Content:The reading is same as 2nd column>>
 - 0603N7R0D500NT 1001000010 4 (Quantity unit: Kpcs)
- **4th Column: -11980293-083001181402- 16 0100002974 002**
 - (1). - : Tap (6). 0100002974 : Batch number of bulk
 - (2). 11980293 : Employee number (7). 002 : Series of copies
 - (3). 083001 : Mouth , Date, Year (The date of printing)
 - (4). 181402 : Hour, minute, second (Printing Time)
 - (5). 16 : Copies of label(with same batch number)

Appendix 1 Bending test

1. Testing Substrate:

The testing substrate shall be the testing substrate A given in Fig.1, the substrate shall be that of class GE4 specified in JIS C6484 or at least the equivalent, the thickness shall be 1.6mm and thickness of copper foil be 0.035mm.

Fig. 1. Testing printed wiring board A
(for use in test for resistance of board to bending)

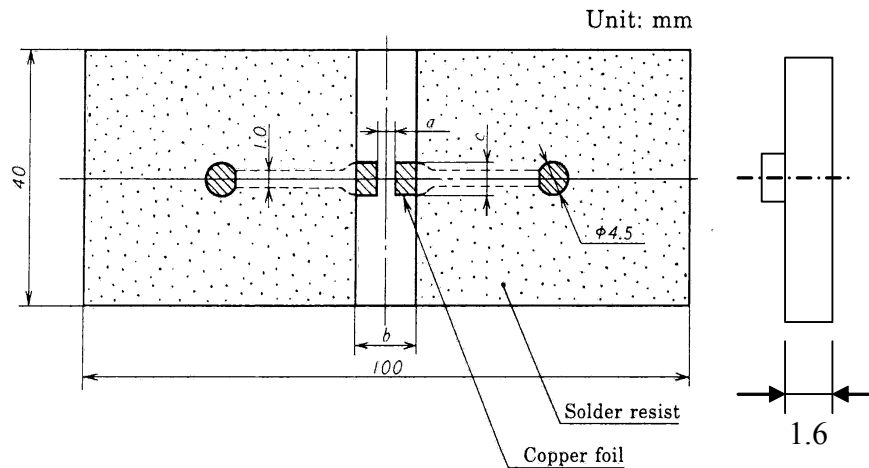

External Size of Capacitor		Dimensions of Pattern (Unit : mm)			
Symbol	W*L	a	b	c	d
0402	0.5*1.0	0.4	1.5	0.5	1.0
0603	0.8*1.6	1.0	3.0	1.2	1.0
0805	1.25*2.0	1.2	4.0	1.65	1.0
1206	1.6*3.2	2.2	5.0	2.0	1.0
1210	2.5*3.2	2.2	5.0	2.9	1.0
1812	3.2*4.5	3.5	7.0	3.7	1.0

2. Testing Method:

- 2.1 The capacitor shall be soldered to testing substrate A.
- 2.2 The substrate shall be so placed with its surface on which capacitor is mounted downwards that the center of capacitor coincides with the center of supports as illustrated in Fig2.

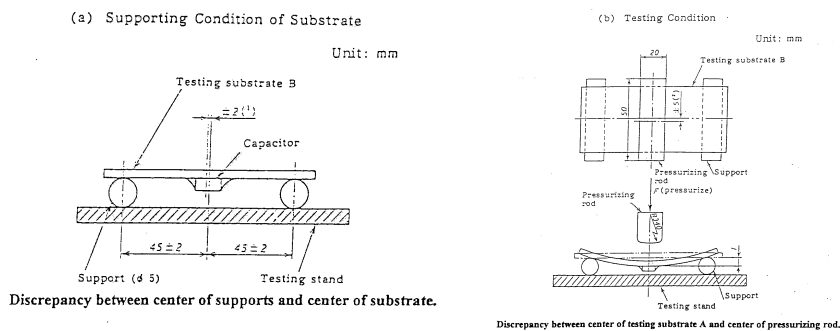

Fig.2 Flexural test of substrate

Appendix 2 Adhesive strength of termination

1. Testing Substrate:

The testing substrate shall be the testing substrate A illustrated in Fig.1.

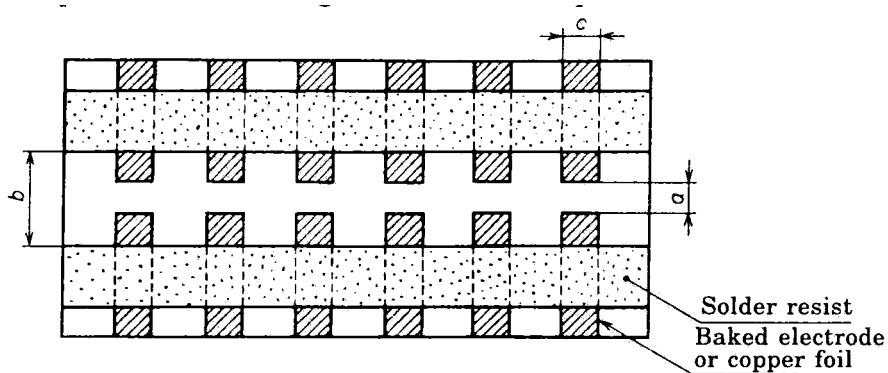

Fig.1 Testing substrate A

External Size of Capacitor		Dimensions of Pattern Unit : mm		
Symbol	W*L	a	b	c
0402	0.5*1.0	0.4	1.5	0.5
0603	0.8*1.6	1.0	3.0	1.2
0805	1.25*2.0	1.2	4.0	1.65
1206	1.6*3.2	2.2	5.0	2.0
1210	2.5*3.2	2.2	5.0	2.9
1812	3.2*4.5	3.5	7.0	3.7

Remark : Material of substrate shall be alumina or glass fabric base epoxy resin.

Alumina : purity 95% or more, thickness 0.6mm or more.

Glass fabric base epoxy resin : Class GE4 specified in JIS C6484 or the equivalent.

Thickness 1.6mm and copper foil thickness 0.035mm.

2. Testing Method:

The pressurizing force shall be gradually applied to the center side surface of capacitor in the capacitor in the direction horizontal and parallel to the testing substrate as shown in Fig.2.

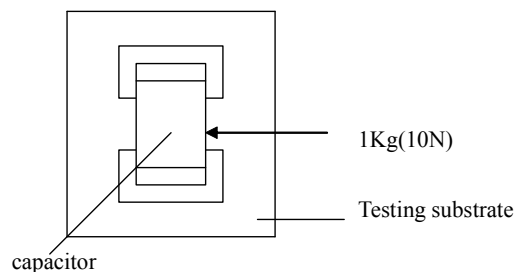

Fig.2 Direction of Pressurizing