





DYNAMIC SERIES CONNECTORS

2024 Edition

RoHS
Ready 

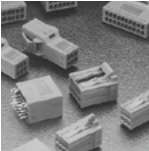
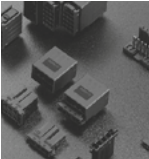
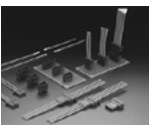
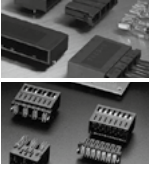
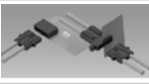

List of the Dynamic series connectors

Series Name				Mechanical Performance													
Series	Family images	Sub-series	Description	Mounting Methods											Number of positions		
				Wire-to-Wire	Wire-to-board				Panel mount	DIN Rai	Tap	Wire	Drawer	Board to Board			
					DIP		SMT										
Vertical type	Horizontal type	Vertical type	Horizontal type														
Mini		Mini	Double-row Standard	–	–	–	–	○	–	–	–	–	–	–	–	12,16,20,24, 28,32,36,40,44	
Slim		Slim	Small Standard	○	–	–	–	–	–	–	–	–	–	–	–	2,3,4,5,6,7,8,9,12,18,24	
1000		1100S	Standard	–	○	○	–	–	–	–	–	–	–	–	–	4,8,10,12,16	
		1100D	Standard	○	○	○	○	–	○	–	–	–	–	–	–	10,18,20,22,24, 26,28,34,40	
		1200S	High Voltage	○	○	–	–	–	–	–	–	–	–	–	–	–	2
		1200D	High Voltage	○	○	○	–	–	○	–	–	–	–	–	–	–	4,6,8,10,12,16,20
		1500T	Module Type	–	○	○	–	–	○	○	–	○	–	–	–	–	3,6,9,10, 12,36
		1900D	Spring Clamp Type	–	○	○	–	–	–	–	–	–	–	–	–	8,12,16,22,30,38	
2000		2100S	Standard	○	○	○	–	–	○	–	–	–	–	–	–	3	
		2100D	Standard	○	○	○	–	–	○	–	–	–	–	–	–	–	6,8,12,16,20
		2100M	Multiposition Drawer	○	–	○	–	–	○	–	–	–	○	–	–	–	50
		2600D	Hybrid Power/Signal	–	○	–	–	–	–	–	–	–	–	–	–	–	48
		2800	Multi-Frame	○	–	–	–	–	○	–	–	–	–	–	–	–	30
		2950	Spring Clamp Type	–	–	○	–	–	–	–	–	–	–	–	–	–	5,6
		2970	On-Site Push-In Type	–	–	–	–	○	–	–	–	–	–	–	–	3,4	
3000		3100S	Standard & SMT	○	○	○	○	○	○	–	–	–	–	–	–	3,4,5,6,8,10	
		3100D	Standard	○	○	○	–	–	○	–	–	–	–	–	–	–	6,8,10,12,16,20
		3100M	Module Type	–	○	○	–	–	–	–	–	–	–	–	–	–	6
		3200S	High Voltage	○	○	○	–	–	○	–	–	–	–	–	–	–	2,3,4,5,6
		3200M	High Voltage	○	○	○	–	–	○	–	–	–	○	–	–	–	6,10,12,20
		3200FMLB	Sequential type	–	–	○	–	–	–	–	–	–	–	–	–	–	4,12
		3200T	High Voltage	–	–	○	–	–	–	–	–	–	–	–	–	–	9
		3400F	Skyscraper	–	–	○	–	–	–	–	–	–	–	–	–	–	12,20
		3500D	Modular Type	○	○	○	–	–	○	–	–	–	–	–	–	–	2,4,6,12,20
		3800	Multi-Frame	○	–	–	–	–	–	○	–	–	–	–	–	–	12
		3100/3200	Dynatap	–	–	–	–	–	–	–	○	–	–	–	–	6,18,24/ 4,24	
		3950	Spring Clamp Type	–	–	○	–	–	–	–	–	–	–	–	–	3,4,6,7,8,11	
4000		4200S	Standard	○	○	○	–	–	○	–	–	–	–	–	–	2,3,4	
		4200M	Module Type	○	○	–	–	–	○	–	–	–	–	–	–	–	6,8
		4800	Multi-Frame	○	○	–	–	–	○	–	–	–	–	–	–	–	8
		4950	Spring Clamp Type	–	–	○	–	–	–	–	–	–	–	–	–	–	8
5000		5200S	Standard	○	○	○	–	–	○	–	–	–	–	–	–	2,3,4,6	
		5200M	High Voltage	○	○	○	–	–	○	–	–	–	–	–	–	–	4,6,8
		5300S	Reversed Housing	–	–	–	–	–	–	○	–	–	–	–	–	–	3
		5300D	Reversed Housing	–	–	–	–	–	–	○	–	–	–	–	–	–	4
		5200	Dynatap	–	–	–	–	–	–	○	○	–	–	–	–	–	4,12,20
		5200Ma	High Current	–	–	○	–	–	–	–	–	–	–	–	–	–	2,4
			Dyna-Clamp kit	○	○	○	–	–	○	–	–	–	–	–	–	–	3,4
			DZ-5200 Board-to-Board type	–	–	–	–	–	–	–	–	–	–	–	○	–	5,7
		–	–	–	–	–	–	–	–	–	–	–	○	–	3,4		
		5800	Multi-Frame	○	–	–	–	–	○	–	–	–	–	–	–	4	
		5900	Spring Clamp Type	–	–	○	–	–	–	–	–	–	–	–	–	4,6	
7000		7100	Standard	○	–	○	–	–	○	–	–	–	–	–	–	4	
		7300	Reversed Housing	○	–	○	–	–	○	–	–	–	–	–	–	–	4
			Dyna-Clamp kit	○	–	–	–	–	–	–	–	–	–	–	–	–	4
8000		8000	Standard	–	○	–	○	○	○	○	○	○	○	○	○	2	
Other products		Multiple Enclosure Connector							○						15,24,32		

List of the Dynamic series

Series Name			Number of Rows	Pitch (mm)	Wire Range (AWG)	Electrical Performance				Safety Standards	Corresponding Pages							
Series	Sub-series	Description				Maximum rated current (A)	Maximum rated voltage (V)	Withstanding Voltage (V)	Durability (Cycles)	UL CSA TÜV								
Mini	Mini	Double-row Standard	2	1.8	22-26	3	250	650	30	UL : File No. E28476	10-13							
Slim	Slim	Small Standard	1,2,3,4	—	22-30	4.5	250	1500	30	UL : File No. E28476	14-17							
1000	1100S	Standard	1	2.0	30-22	3	125	1000	Gold: 100 Tin: 30	UL : File No. E28476 TÜV : License No. R50085096	22-23							
	1100D	Standard	2	2.0	30-22	3	125	1000			24-26							
	1200S	High Voltage	1	2.5	30-18	5	250	1500			27							
	1200D	High Voltage	2								28-30							
	1500T	Module Type	3,4	3.5	31-33													
1900D	Spring Clamp Type	2	3.5	24-18	4	150	1500	UL : File No. E60677	34									
2000	2100S	Standard	1	2.5	28-18	5	250	1500	500	UL : File No. E28476 CSA : Report No. LR7189 TÜV : License No. R9950679	39							
	2100D	Standard	2		40-41													
	2100M	Multiposition Drawer	2		20	2.6	42											
	2600D	Hybrid Power/Signal	3	D-2(2.5) D-3(3.81)	D-2(28-18) D-3(28-14)	D-2(3.2) D-3(7.5)	250	500	UL : File No. E28476 CSA : Report No. LR7189 TÜV : License No. R9950679	43								
	2800	Multi-Frame	6	3.75	28-18	5	600	2200	Gold: 500	UL : File No. E60677	104-106							
	2950	Spring Clamp Type	1	5.08	18-14	10	600	2200	Gold: 500	UL : File No. E60677	72							
3000	2970	On-Site Push-In Type	1	5.0	24-14	10(UL)/20(IEC)	300(UL)/400(IEC)	2210	Gold: 100; Tin: 25	UL : File No. E60677 VDE : Report No. 40051749	78							
	3100S	Standard & SMT	1	3.81	28-14	15	800	2600	Gold: 500 Tin: 100	UL : File No. E28476 CSA : Report No. LR7189 TÜV : License No. R50084673 (VDE0627)	49-52							
	3100D	Standard	2	3.81							53-54							
	3100M	Module Type	2	3.81							55							
	3200S	High Voltage	1	5.08							56-58							
	3200M	High Voltage	2	5.08							59-63							
	3200FMLB	Sequential type	2	5.08							64							
	3200T	High Voltage	3	5.08							65-66							
	3400F	Skyscraper	4	3.81							67							
	3500D	Modular Type	2	5.08							68-69							
3800	Multi-Frame	4	6.5	107														
3100/3200	Dynatap	3,6	3.81	28-14	15	250	1500	79-81										
4000	3950	Spring Clamp Type	1,2	7.5	22-14	14.5	600	2200	Gold: 500	UL : File No. E60677	73							
	4200S	Standard	1	6.35	16-12	24	600	2500	25	UL : File No. E28476 TÜV : License No. R50084673	86-87							
	4200M	Module Type	2	6.35		24	600	2500			88							
	4800	Multi-Frame	4	6.35		24	600	2500			UL : File No. E28476	107						
4950	Spring Clamp Type	1	7.5	16-10	22	600	3310	Gold: 500	UL : File No. E60677	74								
5000	5200S	Standard	1	10.16	16-10	30	630	3000	0.76µ Gold: 50 0.38µ Gold: 25	UL : File No. E28476 CSA : Report No. LR7189 TÜV : License No. R9650368	93-94							
	5200M	High Voltage	2								95-96							
	5300S	Reversed Ho-using	1								98-100							
	5300D	Reversed Ho-using	2								99							
	5200	Dynatap	3								97							
	5200Ma	High Current	2								20-8	45	Silver: 25	100-101				
	—	Dyna-Clamp kit	1								16-10	30	0.76µ Gold: 50 0.38µ Gold: 25	—	100-101			
	DZ-5200	Board-to-Board type	1								5.08	—	20	250	2200	15	UL : File No. E28476 CSA : Report No. LR7189 TÜV : License No. R50073218	102-103
	5800	Multi-Frame	2								10.16	30	600	4000	107			
5900	Spring Clamp Type	1	13.1	16-8	42	600(IEC)	2200	0.76µ Gold: 50 0.38µ Gold: 25	UL : File No. E28476 CSA : Report No. LR7189	75								
7000	7100	Standard	2	16	16-6	60 (board-to-wire) 65 (wire-to-wire) 55 (wire-to-wire cable clamp type)	630	3000	0.76µ Gold: 20	UL : File No. E28476 TÜV : License No. R9650368	111							
	7300	Reversed Ho-using	2	16	16-6						112							
	—	Dyna-Clamp kit	2	16	—						113							
8000	8000	Standard	1	24.4	3	100A (wire-to-wire) 90A (wire-to-board)	1000	3000	10	—	114-117							
Other products	—	Multiple Enclosure Connector	4,8	See details in series page		See details in series page				See details in series page	118-120							

Contact Features (Example of the D-3000 Series connectors)

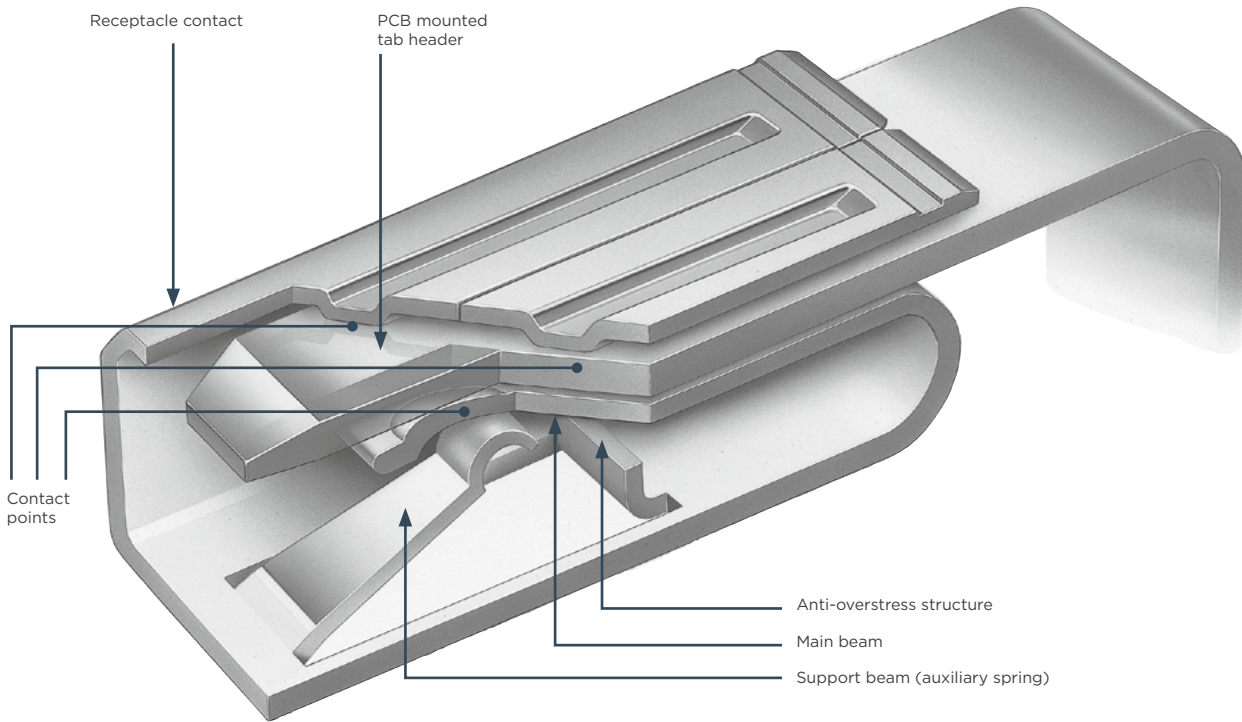

(Illustration of the D-3 contact)

Contact Pressure Adjustment Method

- Gold and Tin contacts are available. Adjustable gaps for the auxiliary spring (at positions of A-C) to get the well-suited contact pressure. For gold-plated product, both high pressure contact and standard pressure contact are available in accordance with the intended use
- Anti-overstress structure helps prevent damage to the main beam which might be caused by insertion of external objects or twisting (Receptacle contact type of D-2 S, M/D-3 S, M, L, 2L, 3L/D-5 S, M)

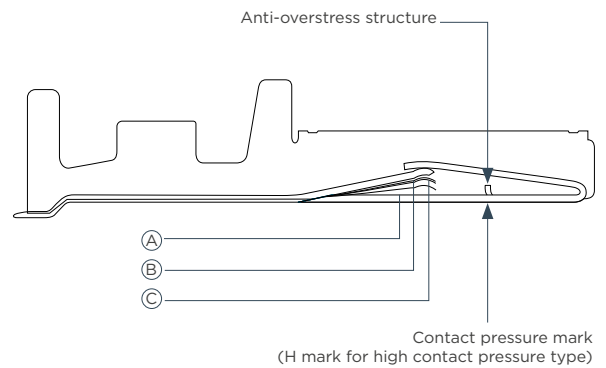

(Applicable to the D-3 terminal)

Plating	Type	Contact Pressure	Position	Contact Pressure Mark	Applicable Positions	Specifications	Application	Durability approximates cycles
Gold	Standard Contact Pressure	Around 1.47N	Ⓐ	—	1-100	Standard	Used for signal/power multi-position and High durability cycles circuits	500
	High Contact Pressure	Around 2.45N	Ⓑ	H	1-20	Vibration / High Current	Used for signal/Power supply/ Motor application with high-vibration feature	500
Tin	High Contact Pressure	Around 3.92N	Ⓒ	H	1-10	High Current	Used for signal/Power supply circuit with few durability cycles	100

Contact Features (Example of the D-3000 Series connector)

Tab/Receptacle Contact

Male side is tab, while female side is receptacle contact so as to avoid twisting. (Refer to figure below) Highly reliable 3-point contacts are used.

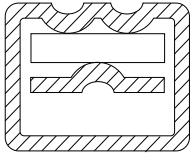

Fixing of the contact and housing

The housing lance is used to secure the contact in place. The lance ensures the contact stays secure in the housing and helps prevent damage during contact mating. In addition to these protective features, the housing lance produces an audible “click” helping ensure the contact is securely locked in the housing. The contact can still be easily removed with extraction tool.

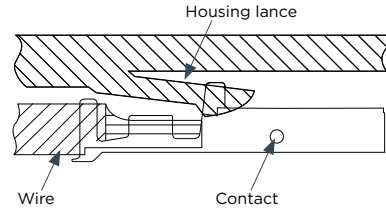

Confirmation Marks

- Contact Pressure marks.....“H” mark on the bottom of the contact for high pressure contact product (standard pressure contact for those without the marks) (Only for D-3 contact)
- Plating marks.....To show clearly types and thickness of the plating. Following numbers will be marked on the side surface of the contact. This number is consistent with the additional number of contact’s part model number.
 - 2.....Gold plating of 0.38µm in thickness
 - 3.....Gold plating of 0.76µm in thickness
 - 5.....Tin plating
- Marking both contact series (D-1/D-2/D-3/D-4/D-5) and wire range (SS,S,M,L) on side surface of contact aim to avoid

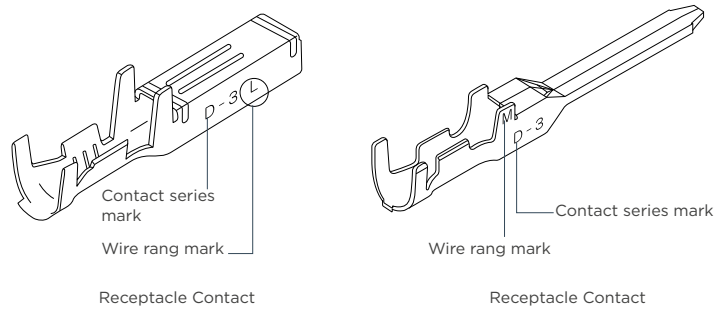
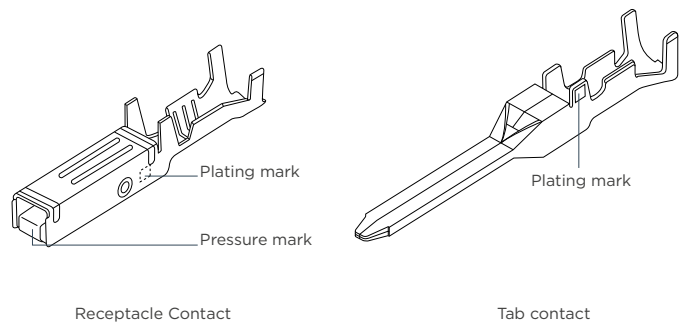

Wire range marks

D-1	SAWG#30-28
	MAWG#28-22
	LAWG#28-22
	2LAWG#22-18
D-2	SAWG#28-24
	MAWG#22-18
D-3	SAWG#28-24
	MAWG#24-20
	LAWG#20-16
	2LAWG#16-14
D-4	MAWG#16-14
	LAWG#14-12
D-5/D5a	SSAWG#20-16
	SAWG#16-14
	MAWG#12-10
	LAWG#8

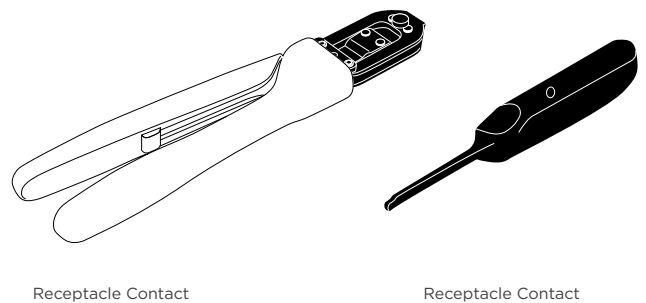

Housing Features (Example of the D-3000 Series connector)

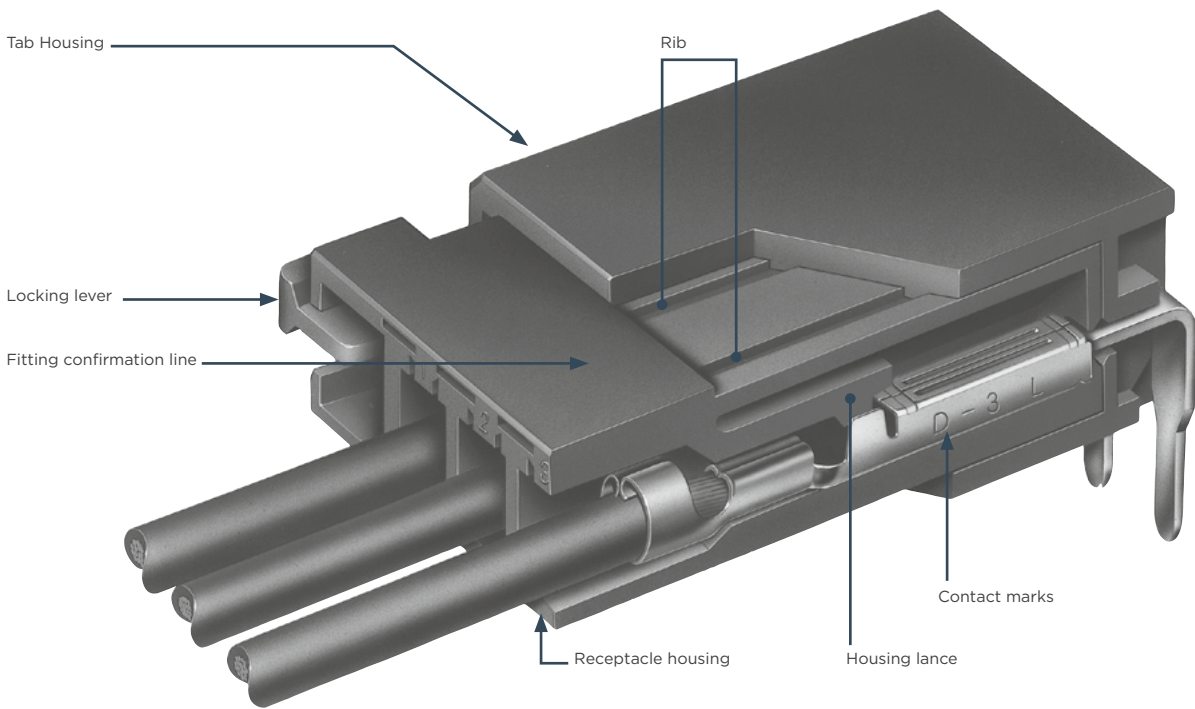

(Illustration of the D-3000 series connector)

Easier to insert and extract the connector

- When you insert or extract the connector, a clear “click” sound will be heard. A fitting confirmation line is provided to confirm the operation
- Pinch 2 locking levers on both sides of the housing to easily extract the receptacle side (D-3000/D-3200/ D-4000/D-5200 series connector)
- For safety consideration, well rounded corners will be used to help prevent hand injuries when inserting or extracting the connector

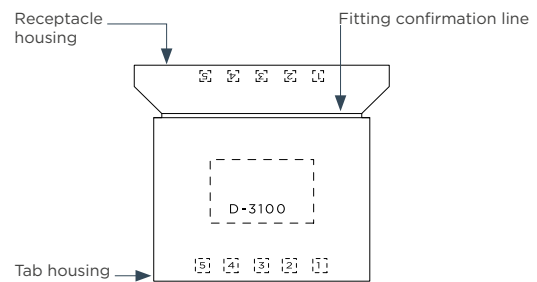
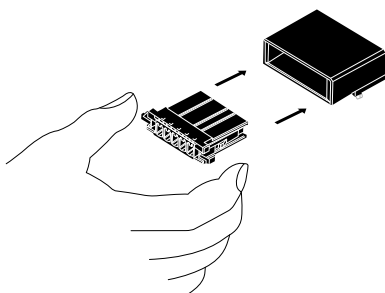

Vertical - type header

- To avoid mis- installation or mis- alignment of the header on board, pay attention to direction indicator (concave) of vertical-type header (only available for D-3000 Series)

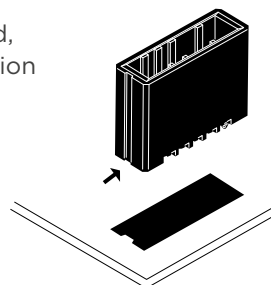

Housing to protect Tin-plated contacts

- For protecting the soldering Tin-plated contacts, housing of horizontal type of header will be fully applied to cover contacts.

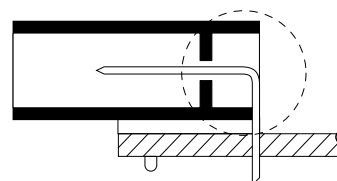

Housing Features (Example of the D-3000 Series connector)

Retention legs for board mounting

- For robotic automatic implementation, the retention legs will be provided for both the vertical-type and the horizontal-type headers.
- Especially for the horizontal-type header, it is possible to mount to the bottom of the housing and it will not take up as wide a space as the conventional system. Retention legs are close to the insertion part of the receptacle housing so as to resist tilting caused by the cable.

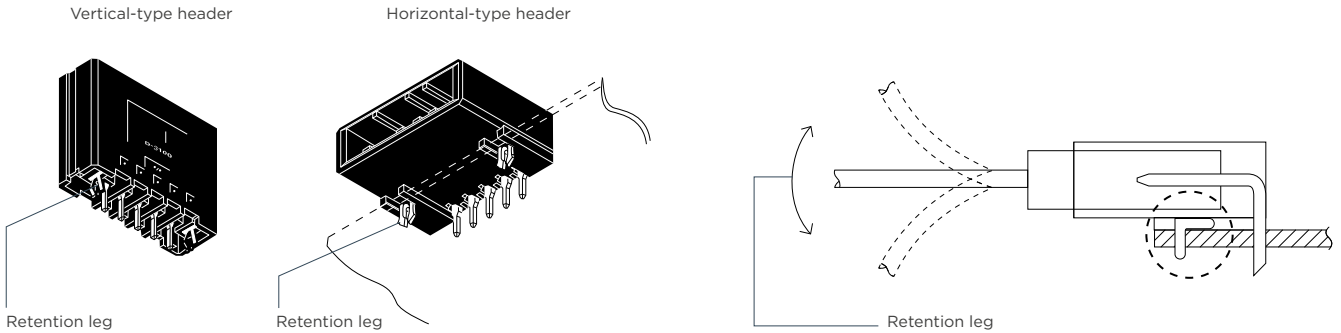

Note: The fixing pins are of the same thickness as the 1.6mm thickness circuit board. When they are used for a 2.4mm thickness circuit board, the strength will decrease somewhat.

Twisting Prevention Structure

- The ribs are used in both receptacle housing and tab housing. This safety design can be used to significantly reduce backlashes between housings after the receptacle housing has been completely inserted into tab housing.

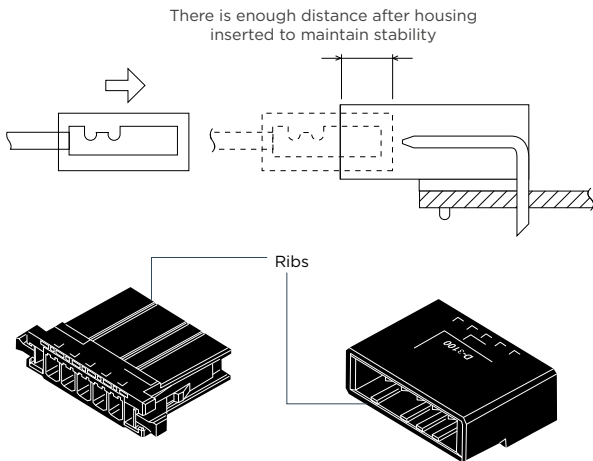

Anti-mis-mating structure

- Part of the products (D-1200D/ D-2100S/ D-2100D/ D-3100S/ D-3100M/ D-3200S/ D-3200M/D-3200T/ D-4000/ D-5200S/ D-5200M) is provided with key to prevent incorrect insertion. This plug, also makes it easier to prevent incorrect insertion of other items. (refer to Page 121, which shows the information of keying plug, for D-2000 series only; and Page 121, for D-3000 series only)

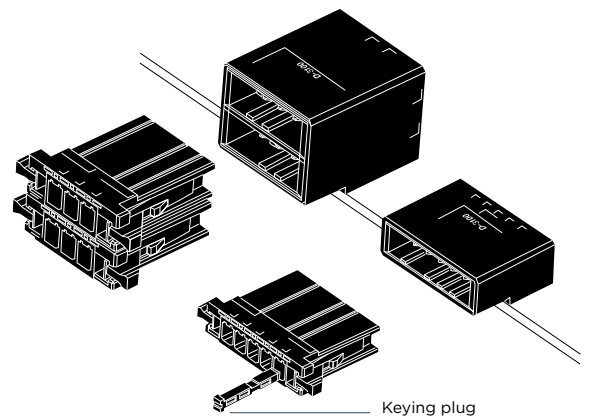

Label Mark

- A flat side portion is provided in the housing for custom labels.

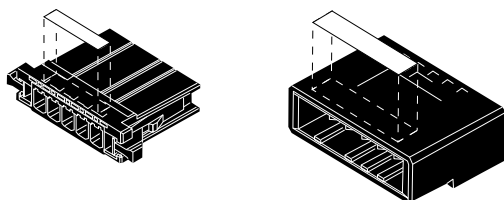

Easy-to-read circuit number

- To facilitate cable assembly, tab and receptacle housings will be marked with circuit numbers.

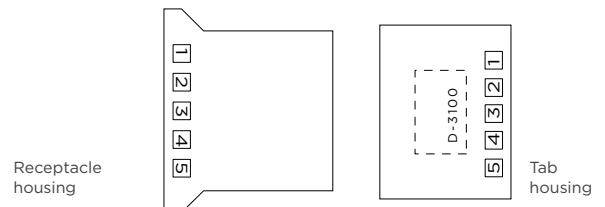

Guideline for plating selection

(These guidelines apply to the Dynamic D-3000 series connectors series only. Please note that they may not be suitable for other products.)

Whether to use gold or tin plating depends on the voltage, current, environment (vibration, temperature, gas, etc.), number of contact positions, and other variables.

Gold plating is recommended for general industrial machinery, but in reality cost considerations are also a factor. To help in this selection, these guidelines have been put together for Dynamic series as a reference in the selection process.

(1) Selection based on voltage and current

	Gold plated	Undetermined zone	Tin	No plating (Reference)
Voltage	Below 3 V	3 to 30 V	30 - 100 V	Over 100 V
Current	Below 1 A	1 to 10 A	Over 10 A	Over 0.1 A

(Table 1)

Table 1 shows us that gold should always be used for applications under 3 volts and 1 ampere. When the voltage is over 30 and amperage is over 10, tin plating can be used. The most difficult area to make a selection is in the undetermined zone. In this zone either gold or tin plating can be used, and environmental parameters are the key variation to consider due to extensive impact on the application.

In a clean environment tin plating is acceptable. However, use gold plating if the environment is harsh, such as high heat or humidity, the presence of gas is possible, vibration is extreme, mating and demating are frequent, or other factors.

(2) Selection based on number of contact positions (selection based on contact pressure)

Selection based on the number of contact positions is often forgotten. The higher the contact pressure the more possible it is to use tin plating or no plating, regardless of the voltage or current mentioned in section 1. However, if pressure is too high, mating and demating becomes impossible so the connector function is lost. To get around this, we can drive the voltage and current down into a workable zone, but then we run into the problem of oxidation. To prevent oxidation, we use tin (approximately 2.94 N optimum contact pressure) or gold (approximately 1.18 N) plating. Even though, the contact pressure increases proportionally as we increase the number of contact positions, it makes mating and demating difficult. Generally speaking, given a 39.2 N limit for mating/ demating by hand, it becomes difficult without using leverage, such as a lever or jack screw when the limit exceeds.

The D-3000 series connector has a maximum of 20 contact positions. The contact pressure per pin with tin plating is 3.92 N, and with gold plating is 2.45 N and 1.47 N (high pressure types and standard types are available for some applications).

For instance, given 3.92 N for tin plating, the insertion and extraction force of 20-position connector will be 58.8N and 49.0N, which is difficult because it exceeds the range for barehanded work. Therefore, gold plating are selected when position is increased regardless of the voltage and current conditions mentioned in section 1.

Table 2 shows the applicable maximum number of contact positions as a reference.

Contact Pressure	Applicable Maximum Number of Contact Positions	
(1) Gold Standard contact pressure parts:	1.47N	20
(2) Gold High contact pressure parts:	2.45N	20
(3) Tin High contact pressure parts:	3.92N	12

(Table - 2) Note: Insertion force and extraction force are not the same as contact pressure.

(3) Environment (vibration, humidity, gas, etc.)

Although environmental parameters about voltage and current were discussed in section 1, it is summarized again here. Use gold plating in a harsh environment, particularly for high vibration or heat, the presence of gas or other harsh conditions. Gold is a noble metal and does not react easily with other materials which means good resistance to oxidation. This is a very important property for contacts.

Also, if vibration is an issue, fretting corrosion (micro- abrasion) is a risk. In cases like this, gold plating is always the recommended choice.

Guideline for plating selection

(These guidelines apply to the D-3000 series only.
Please note that they may not be suitable for other products.)

(4) Others considerations

Contact between dissimilar metals

Whether to use gold or tin plating depends on the voltage, current, environment (vibration, temperature, gas, etc.), number of contact positions, and other variables.

Being consistent within an application

We recommend that, as much as possible, the same type of plating be used within one application. This is to help prevent connections being made between dissimilar metals, gold and tin as mentioned on the left, during assembly and maintenance.

And for the same reason, we recommend using the same plating in factories or workplaces where assembly or harness production is done.

The above information has been summarized in “Plating selection at a glance” for your convenience.

- ★★★ Best
- ★★ Good
- ★ Usable
- Unacceptable

Platings selection at a glance

Voltage/Current	Application	Tin plated	Gold plated			
			0.38μ		0.76μ	
			Standard pressure	High pressure	Standard pressure	High pressure
Below 3V Below 1A	Standard specifications	—	★★	★★	★★★★	★★★★
	Vibration	—	★	★★	★	★★★★
	Harsh environment	—	★	★	★★	★★★★
	Extensive mating/ unmating	—	★★	★	★★★★	★★
	Many contact positions	—	★★★★	★★	★★★★	★★
3 to 30V 1 to 10A	Standard specifications	—	★★	★★	★★★★	★★★★
	Vibration	—	★	★★	★	★★★★
	Harsh environment	—	★★	★★	★★★★	★★★★
	Extensive mating/ unmating	—	★★	★	★★★★	★★
	Many contact positions	—	★★★★	★★	★★★★	★★
Over 30V Over 10A	Standard specifications		★★★★	★★★★	★★★★	★★★★
	Vibration	—	★★	★★★★	★★	★★★★
	Harsh environment	—	★★	★★	★★★★	★★★★
	Extensive mating/ unmating	—	★★★★	★★	★★★★	★★
	Many contact positions	—	★★★★	★★	★★★★	★★

The above table is based on industrial equipment with sufficient margin reserved. There are various combinations depending on the application, so it is not necessarily as shown in the above table, which is for reference only.

Mini Dynamic Series connector

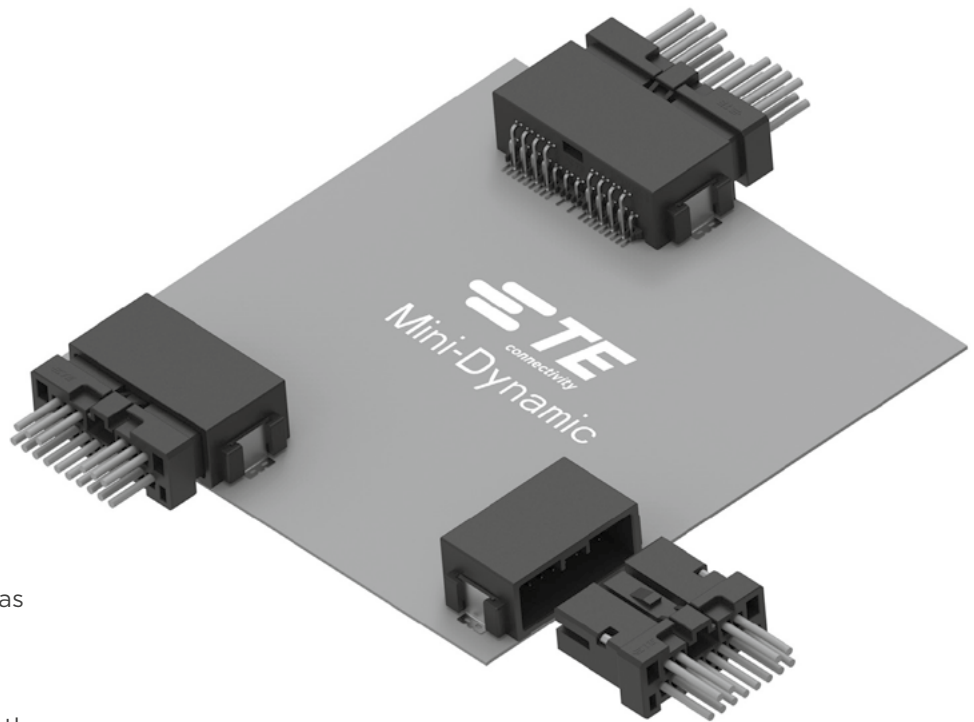

Series Introduction

The Dynamic Mini Sub-series, as the name suggests, are the smallest connectors in the Dynamic family, with superior low profile design, both in height and pitch. It is highly reliable for use in applications where board space is at a premium.

The Dynamic Mini Sub-series is superior in design with the same performance features found in all Dynamic products:

- Crimped terminals on the wire end
- Audible-tactile locking mechanism for male and female mating
- Double locking design for the wire-end terminals in the wire-end plastic housing
- Protective latch concept to help ensure the reliability of the connection

It is also worth mentioning that halogen-free materials are used for the board-end plastic housing.

The higher reliability and smaller size make the Mini Sub-series not only usable in the industrial environment, but can also easily meet the needs of other applications in automotive and robotics, which require higher vibration resistance.

Product Highlights

1. Small size

The Dynamic Mini Series has a lower profile than the D-1100 D Series, especially in the height, which provides more valuable space on the board.

2. Secondary locking design

Dynamic Mini introduces the secondary locking design, in addition to the conventional terminals for cable wrapping and crimping. There is also a flush-mounted latch on the plastic housing which provides additional locking of the terminal into the plastic housing increasing reliability. This further helps reduce the risk of the cable loosening.

3. Sunken unlocking structure

In addition to inheriting the superior audible-tactile locking design of the Dynamic Series, the Mini sub-series has a unique protective latch concept. Compared to the D-1200 series, which raises the plastic housing around the unlocking structure

to protect the latch and prevent accidental unlocking. The Dynamic Mini achieves the same function through a sunken design that is more user-friendly.

4. Tin-plated terminals

The choice of tin plating, together with the secondary locking and sunken unlocking structure, makes the Dynamic Mini products cost effective.

5. Board-end surface-mount (SMT) design

The choice of tin plating, together with the secondary locking and sunken unlocking structure, makes the Dynamic Mini products cost effective. The soldering plate of the terminal is surface-mounted (SMT), which facilitates automatic pick and place.

NOTE: All products are RoHS compliant On selection.

Mini Dynamic Series Performance and Specifications

Performance

Item	Series	Mini Dynamic
Pitch		1.8 mm
Rated voltage (max)		250V AC/125V DC
Rated current (max)		3A
Contact resistance		30mΩ max
Withstanding voltage		650V
Operating temperature		-40°C to 125°C

Positions / Wire size / Rated current

Mini Dynamic

Positions	Cable size (AWG)		
	22	24	26
12-20	3	2	1
24-44	3	2	1

Product Specification and Instruction Sheet

Product Specification	108-137443 (reference for industrial field) 108-137526 (reference for automotive field)
Application Specification	114-137526 (for receptacle contact) 114-137527 (for receptacle connector assembly)

Materials and Plating

Category	Material
Contact	Copper alloy
Plating in mating area	Tin over nickel underplated
Plastic housing	UL94-V-0
Plastic housing of header	High temperature nylon, halogen free
Plastic housing of receptacle (wire end)	PBT (with halogen free version)
Retention pin	Copper alloy
	X and Y mechanical codings

Mini Series Contact

Crimp Contacts



Wire Range				Receptacle Contact		Application Toolings		
AWG	mm ²	Outer diameter of insulation mm	Wire range mark	Plating	Strip Form	Hand Tool	Ocean Applicator	Extraction Tool
26	0.13-0.17	0.85-1.10	S	Tin	2834464-5	2402611-1	2151332-2	2834501-1*
24-22	0.22-0.35	0.95-1.30	M	Tin	2834464-6	2401910-1	2151524-2	

Mini Dynamic Double-row Standard Types - 1.8mm pin pitch

Type Chart

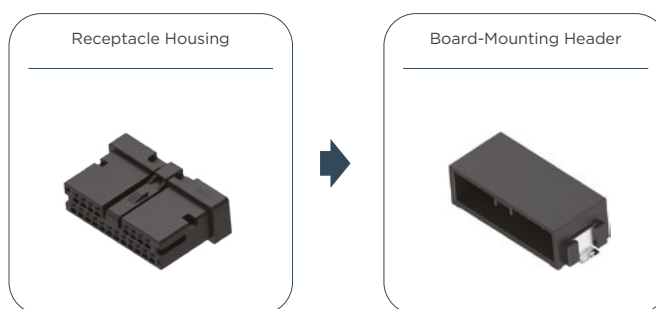

Pos.	Color	Key	Receptacle		Header (Halogen free)
			Standard	Halogen free*	Tin plating
12	Black	X	1-2834461-2	1-2834627-2	1-2834465-2
	Black	Y	1-2834497-2	1-2834628-2	1-2834499-2
16	Black	X	1-2834461-6	1-2834627-6	1-2834465-6
	Black	Y	1-2834497-6	1-2834628-6	1-2834499-6
20	Black	X	2-2834461-0	2-2834627-0	2-2834465-0
	Black	Y	2-2834497-0	2-2834628-0	2-2834499-0
24	Black	X	2-2834461-4	2-2834627-4	2-2834465-4
	Black	Y	2-2834497-4	2-2834628-4	2-2834499-4
28	Black	X	2-2834461-8	2-2834627-8	2-2834465-8
	Black	Y	2-2834497-8	2-2834628-8	2-2834499-8
32	Black	X	3-2834461-2	3-2834627-2	3-2834465-2
	Black	Y	3-2834497-2	3-2834628-2	3-2834499-2
36	Black	X	3-2834461-6	3-2834627-6	3-2834465-6
	Black	Y	3-2834497-6	3-2834628-6	3-2834499-6
40	Black	X	4-2834461-0	4-2834627-0	4-2834465-0
	Black	Y	4-2834497-0	4-2834628-0	4-2834499-0
44	Black	X	4-2834461-4	4-2834627-4	4-2834465-4
	Black	Y	4-2834497-4	4-2834628-4	4-2834499-4

NOTE: All products are RoHS compliant on selection.
* Preliminary to release

Mini Dynamic Double-row Standard Types – 1.8mm pin pitch

Relative Product Information

Applicable contact...P.12
Performance & specifications...P.11

Mated Dimensions

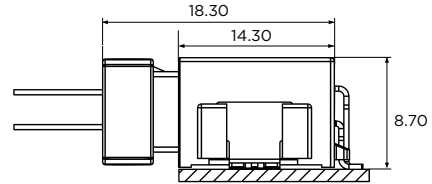

External Dimensions

- Receptacle Housing

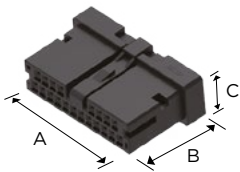

Pos.	Color	Key	Part Number		Dimensions		
			Standard	Halogen free*	A	B	C
12	Black	X	1-2834461-2	1-2834627-2	19.3	15.7	8.35
	Black	Y	1-2834497-2	1-2834628-2			
16	Black	X	1-2834461-6	1-2834627-6	22.9		
	Black	Y	1-2834497-6	1-2834628-6			
20	Black	X	2-2834461-0	2-2834627-0	26.5		
	Black	Y	2-2834497-0	2-2834628-0			
24	Black	X	2-2834461-4	2-2834627-4	30.1		
	Black	Y	2-2834497-4	2-2834628-4			
28	Black	X	2-2834461-8	2-2834627-8	33.7		
	Black	Y	2-2834497-8	2-2834628-8			
32	Black	X	3-2834461-2	3-2834627-2	37.3		
	Black	Y	3-2834497-2	3-2834628-2			
36	Black	X	3-2834461-6	3-2834627-6	40.9		
	Black	Y	3-2834497-6	3-2834628-6			
40	Black	X	4-2834461-0	4-2834627-0	44.5		
	Black	Y	4-2834497-0	4-2834628-0			
44	Black	X	4-2834461-4	4-2834627-4	48.1		
	Black	Y	4-2834497-4	4-2834628-4			

- Board-Mounting Header

Horizontal type

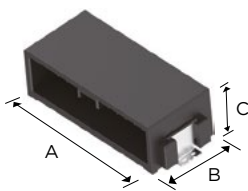

Pos.	Color	Key	Part Number	Dimensions		
			Tin plating	A	B	C
12	Black	X	1-2834465-2	19.5	12.3	8.7
	Black	Y	1-2834499-2			
16	Black	X	1-2834465-6	23.1		
	Black	Y	1-2834499-6			
20	Black	X	2-2834465-0	26.7		
	Black	Y	2-2834499-0			
24	Black	X	2-2834465-4	30.3		
	Black	Y	2-2834499-4			
28	Black	X	2-2834465-8	33.9		
	Black	Y	2-2834499-8			
32	Black	X	3-2834465-2	37.5		
	Black	Y	3-2834499-2			
36	Black	X	3-2834465-6	41.1		
	Black	Y	3-2834499-6			
40	Black	X	4-2834465-0	44.7		
	Black	Y	4-2834499-0			
44	Black	X	4-2834465-4	48.3		
	Black	Y	4-2834499-4			

NOTE: All products are RoHS compliant on selection.
* Preliminary to release

Dynamic Slim Series

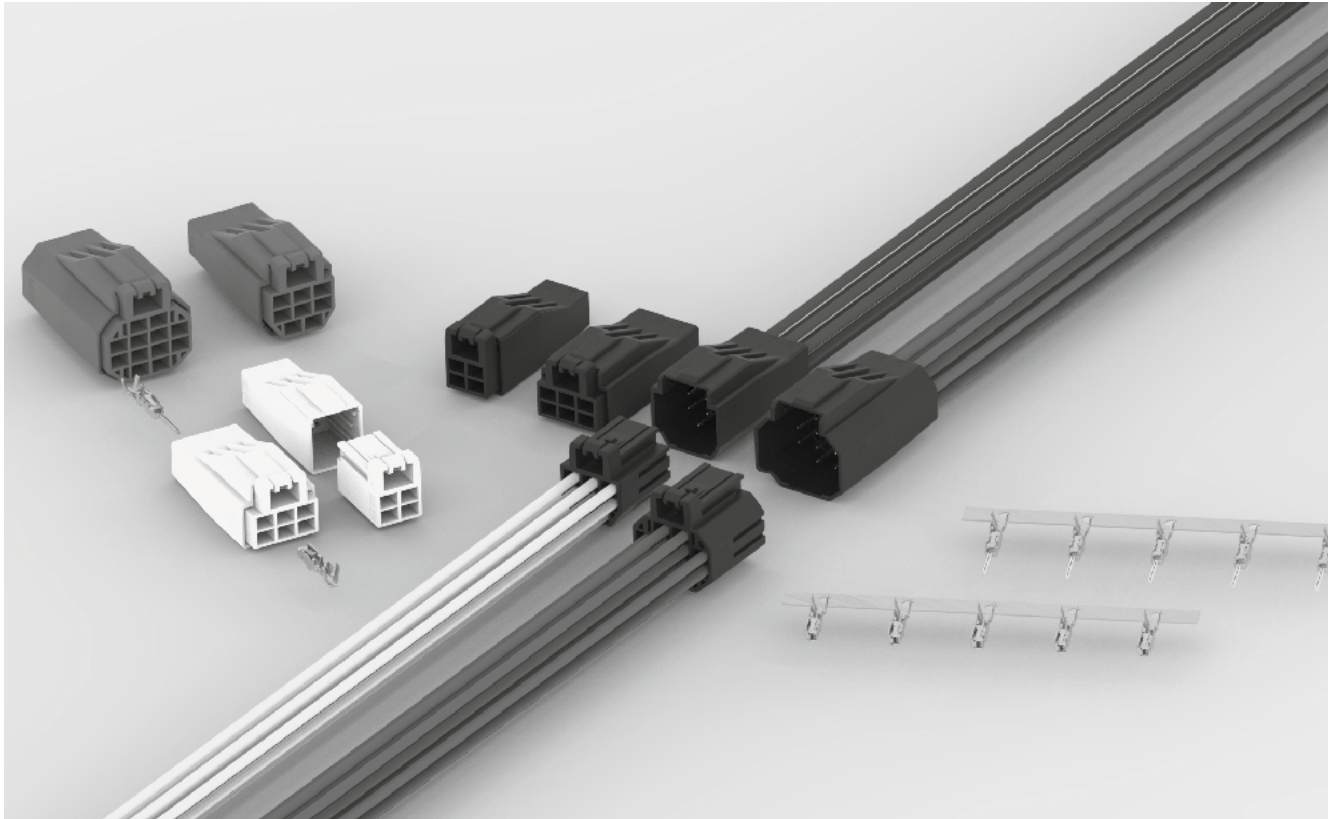

Series Introduction

The Dynamic Slim Series Connector is a wire-to-wire connection solution for smaller devices in the industrial field. An excellent blend of high reliability and smaller size is achieved through a balanced contact arrangement, supporting the trend toward miniaturization of devices.

Product Highlights

1. Small size

The Dynamic Slim Series connector has a size advantage over the D-1100 and D-1200 series based on a near-circular hole layout. This is especially important when the product needs to be used in restricted spaces, such as the internal wiring of robotic arms. The more reasonable hole layout helps improve the efficiency of space usage.

2. Vibration-resistant terminal housing structure

Box receptacles and terminals are highly vibration-resistant. The slots in the housing prevent improper mating and provide high reliability.

3. Effective mating length

Although small, the reliability required for industrial devices is achieved by terminals that provides for effective mating length.

4. Latching

When mating, a clear locking sound and sensation informs the operator, making it possible to complete work virtually without defects such as improper mating (half mating) even in an operating environment where visual inspection is not possible.

Dynamic Slim Series Performance and Specifications

Performance

Rated voltage	AC/DC 250V max.
Withstanding voltage	AC 1,500 V / 1 minutes
Wire Range	AWG # 22 - # 30
Operating temperature	-55°C to +125°C
Durability	up to 30 cycles

Positions / Wire size / Rated current

Dynamic Slim Series

Positions	Cable size (AWG)				
	AWG 22	AWG 24	AWG 26	AWG 28	AWG 30
2-4	4.5	3.9	3.2	2.2	1.6
5-6	4.2	3.4	2.9	2	1.3
7-8	3.8	3.1	2.6	1.8	1.2
9-12	3.5	2.8	2.3	1.6	1.1

Temperature rise: 30°C max

Product Specification and Instruction Sheet

Product Specification	108-140257
Application Specifications	114-5377
Instruction Sheet	408-78197

Positions	Cable size (AWG)				
	AWG 22	AWG 24	AWG 26	AWG 28	AWG 30
2-4	8.6	7.2	6	4.1	3.1
5-6	8	6.4	5.5	3.7	2.9
7-8	7.3	5.8	5	3.2	2.5
9-12	6.5	5.2	4.4	2.9	2.3

Ambient temperature: 25°C temperature rise: 100°C

Materials and Plating

Category	Material	Finish
Receptacle Contact Tab Contact	Copper alloy	Gold plating (0.2µm)
Housing	UL94V-0, thermoplastic PBT with glass fiber	

Dynamic Slim Contact



Receptacle Contact
(for Receptacle housing)



Tab contact
(for Tab housing)

Wire Range		Outer Diameter of Insulation mm	Wire Range Mark	Contact				Applicable Tools			
AWG	mm ²			Plating	Receptacle Contac		Tab Contact		Hand Tool	Micro Applicator	Extraction Tool
					Strip Form	Loose Piece	Strip Form	Loose Piece			
30	0.05	0.6 - 1.2	S	Gold plating	2367817-1	2367818-1	2367819-1	2367820-1	2381707-1 (2119144-1 with 2381710-1)	2151110-1	2323787-1
28	0.08										
28	0.08	1.08 - 1.6	M		2367817-2	2367818-2	2367819-2	2367820-2	2371748-1 (2119141-1 with 2381710-1)	2151082-1	
26	0.12										
24	0.20										
22	0.30										

Slim Small Standard Types

Type Chart

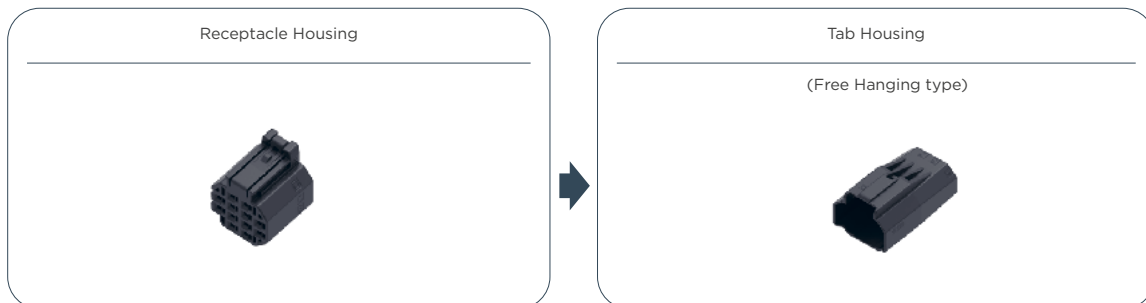

Pos	Key	Receptacle Housing			Tab Housing - Free Hanging type		
		Color			Color		
		Black	Natural	Blue	Black	Natural	Blue
2	X	1-2375948-2	5-2375948-2	7-2375948-2	1-2375951-2	5-2375951-2	7-2375951-2
	Y	2-2375948-2	6-2375948-2	8-2375948-2	2-2375951-2	6-2375951-2	8-2375951-2
3	X	1-2375948-3	5-2375948-3	7-2375948-3	1-2375951-3	5-2375951-3	7-2375951-3v
	Y	2-2375948-3	6-2375948-3	8-2375948-3	2-2375951-3	6-2375951-3	8-2375951-3
4	X	1-2366515-4	5-2366515-4	7-2366515-4	1-2366600-4	5-2366600-4	7-2366600-4
	Y	2-2366515-4	6-2366515-4	8-2366515-4	2-2366600-4	6-2366600-4	8-2366600-4
5	X	1-2375948-5	5-2375948-5	7-2375948-5	1-2375951-5	5-2375951-5	7-2375951-5
	Y	2-2375948-5	6-2375948-5	8-2375948-5	2-2375951-5	6-2375951-5	8-2375951-5
6	X	1-2366515-6	5-2366515-6	7-2366515-6	1-2366600-6	5-2366600-6	7-2366600-6
	Y	2-2366515-6	6-2366515-6	8-2366515-6	2-2366600-6	6-2366600-6	8-2366600-6
7	X	1-2375948-7	5-2375948-7	7-2375948-7	1-2375951-7	5-2375951-7	7-2375951-7
	Y	2-2375948-7	6-2375948-7	8-2375948-7	2-2375951-7	6-2375951-7	8-2375951-7
8	X	1-2366515-8	5-2366515-8	7-2366515-8	1-2366600-8	5-2366600-8	7-2366600-8
	Y	2-2366515-8	6-2366515-8	8-2366515-8	2-2366600-8	6-2366600-8	8-2366600-8
9	X	1-2375948-9	5-2375948-9	7-2375948-9	1-2375951-9	5-2375951-9	7-2375951-9
	Y	2-2375948-9	6-2375948-9	8-2375948-9	2-2375951-9	6-2375951-9	8-2375951-9
12	X	3-2366515-2	5-2366515-2	7-2366515-2	3-2366600-2	5-2366600-2	7-2366600-2
	Y	4-2366515-2	6-2366515-2	8-2366515-2	4-2366600-2	6-2366600-2	8-2366600-2
18	X	1-2423582-8	5-2423582-8	7-2423582-8	1-2423584-8	5-2423584-8	7-2423584-8
	Y	2-2423582-8	6-2423582-8	8-2423582-8	2-2423584-8	6-2423584-8	8-2423584-8
24	X	1-2420333-4	5-2420333-4	7-2420333-4	1-2420334-4	5-2420334-4	7-2420334-4
	Y	2-2420333-4	6-2420333-4	8-2420333-4	2-2420334-4	6-2420334-4	8-2420334-4

Relative Product Information

Applicable contact...P.15

Performance & specifications...P.15

Mated Dimensions

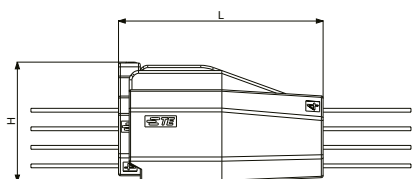

Ps	H	L
4	8.9	21.5
6	8.9	21.5
8	11	21.5
12	13	21.3

* Dimensions are in mm

Slim Small Standard Types

External Dimensions

- Receptacle Housing

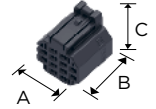

Pos	Key	Plating	Color	Part Number	Dimensions		
					A	B	C
4	X	-	Black	1-2366515-4	6.1	10.5	8.2
	Y		Black	2-2366515-4			
6	X		Black	1-2366515-6	8.8	10.5	8.2
	Y		Black	2-2366515-6			
8	X		Black	1-2366515-8	8.8	10.5	10.2
	Y		Black	2-2366515-8			
12	X		Black	3-2366515-2	11.5	11.3	12.2
	Y		Black	4-2366515-2			

- Tab housing

Free Hanging type

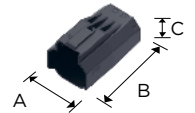

Pos	Key	Plating	Color	Part Number	Dimensions		
					A	B	C
4	X	-	Black	1-2366600-4	7.2	19	8.6
	Y		Black	2-2366600-4			
6	X		Black	1-2366600-6	9.9	19.7	8.6
	Y		Black	2-2366600-6			
8	X		Black	1-2366600-8	9.9	19.7	10.6
	Y		Black	2-2366600-8			
12	X		Black	3-2366600-2	12.6	21	12.6
	Y		Black	4-2366600-2			

D-1000 Series

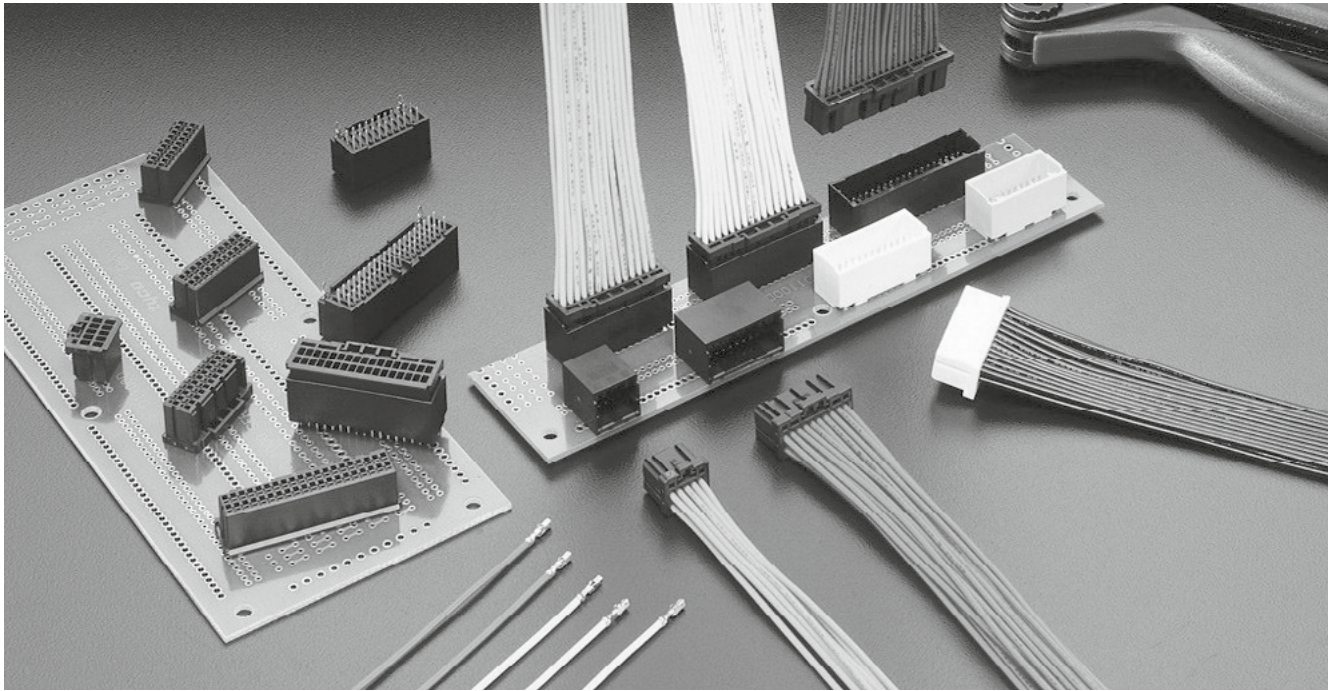

Series introduction

D-1000 Series are the smallest connectors for signal lines among all the Dynamic connector series.

The Dynamic 1000 Series connectors consists of 3 different pitch sizes: 2.0mm standard type, 2.5mm high-voltage type and 3.5mm type. As market needs change, the D-1000 series will evolve to meet those demands.

D-1000 Series has gold plated contacts to maintain its high reliability and also tin plated contacts for economical market needs. Customers can choose their own contacts according to specifications, applications and cost.

Product Features

1. Wide Applicable Wire

From D-1000 series has wide applicable wire range of 30 AWG to 18 AWG with maximum 2.2 mm of outside diameter (D-1200/ D-1500). Therefore there are no special safety considerations using it in electrical cabinets.

2. Hand Tools are available for all wire sizes.

Standard crimping tools can be used for the D-1000 series by exchanging the die. The ability to exchange the die based on difference wire sizes helps shorten the lead-time and significantly reduces the cost of use for the hand tool.

3. Housing and Contact Features

A) Housing products

The D-1000 series consists of D-1100 series with 2.0mm pitch center line, D-1200 series with 2.5mm pitch center line. The D-1500 series is 3.5mm pitch.

In addition to black, the series is also available in other colors. Using different colors in the application can be helpful

in reducing the assembly time.

B) Contact Products

D-1000 series provide gold plating contact as standard products and also tin plating contact for economical market needs. Choose contact according to specifications, application, quality level and cost.

4. Other Features (Basic Dynamic series features)

- Header connector and tab connector have enough length from the tip of contact to top of its housing. To prevent contact from bending during mating
- The positioning dowels in the housing and the terminals do not come into contact, so damage to the terminals during operation can be kept to a minimum.
- Clear identification of circuit number helps with correct wiring
- Metal retention leg on header prevents unwanted movement from cable tension
- Housing lock design helps avoid wire scratching

Note: All models are RoHS compliant.

D-1000 Series Performance and Specifications

Performance

Item	Series	D-1100	D-1200	D-1500	D-1900
Pitch		2.0mm	2.5mm	3.5mm	3.5mm
Rated voltage		125V AC/DC	250V AC/DC	250V AC/DC	150V AC/DC
Rated current (max)		1 pos: 3A	1 pos: 5A	1 pos: 5A	1 pos: 4A
		With WG22	(With AWG18)		With WG18
Contact resistance		20mΩ Max			40mΩ Max
Withstanding voltage		1,000V AC	1,500V AC	1,500V AC	1,100V AC
Operating temperature		-55°C ~+105°C			-30°C ~+105°C

Positions / Wire size / Rated current

D-1100-1500 series

Positions	Wire Size (AWG)						
	18	20	22	24	26	28	30
1	5	4	3	2.5	2	1.5	1
2-20	3.5	2.7	2.5	2	1.5	1	0.8
21-40	—	—	2	1.5	1	0.8	0.5

Product Specification and Instruction Sheet

Product Specifications		108-78268 (gold-plated) 108-78298 (tin-plated) 108-78336 (D-1900)
Applications Specifications		114-5377 (D-1100, D-1200, D-1500) 411-78291(D-1900)
Crimping tool instruction sheet	Part number: 1762952-1	408-10414-JPN
	Part number: 1762846-1	
	Part number: 1762950-1	
	Part number: 1762625-1	
Extraction tool part number: 1891526-1 D-1900 Extraction tool part number: 1891348-1		411-78241 411-78263

Materials and Plating

Category	Material	Finish
Receptacle Contacts Tab Contact	Copper alloy	Tin-plating or 0.38μm gold-plating over 1.27μm Nickel under-plated
Board Mount Header		0.38 μm gold-plating over 1.27 μm Nickel under-plated 2.0 μm Tin-plating on tail side
Housing	UL94V-0, Thermoplastic PBT containing glass fiber	

Safety Standards *Remember to obtain Instruction Sheets when you choose to use these tools.

The safety specifications listed below are approved on specific part numbers. Please contact our sales department to check whether the part numbers you use are approved or not.

Series	D-1100			D-1200, D-1500			D-1900		
	Rated Voltage	Rated Current	Temperature Range	Rated Voltage	Rated Current	Temperature Range	Rated Voltage	Rated Current	Temperature Range
Product Specifications 108-78268	125V AC/DC	3A (1 pos)	-55°C ~+105°C	250V AC/DC	5A (1 pos)	-55°C~+105°C	150V AC/DC	4A (1 pos)	-30°C ~+105°C
UL File No.E28476	Based on requirements of Application		—	Based on requirements of Application		—	Based on requirements of Application		—
TÜV	125V AC/DC	AWG A(1pos) 22 3 24 2.5 26 2 28 1.5 30 1	-55°C ~+105°C		AWG A(1pos) 18 5 20 4 22 3 24 2.5 26 2 28 1.5 30 1	-55°C ~+105°C		AWG A(1pos) 18 4 20 3 22 2.5 24 2	-30°C ~+105°C

D-1000 Series Configurations

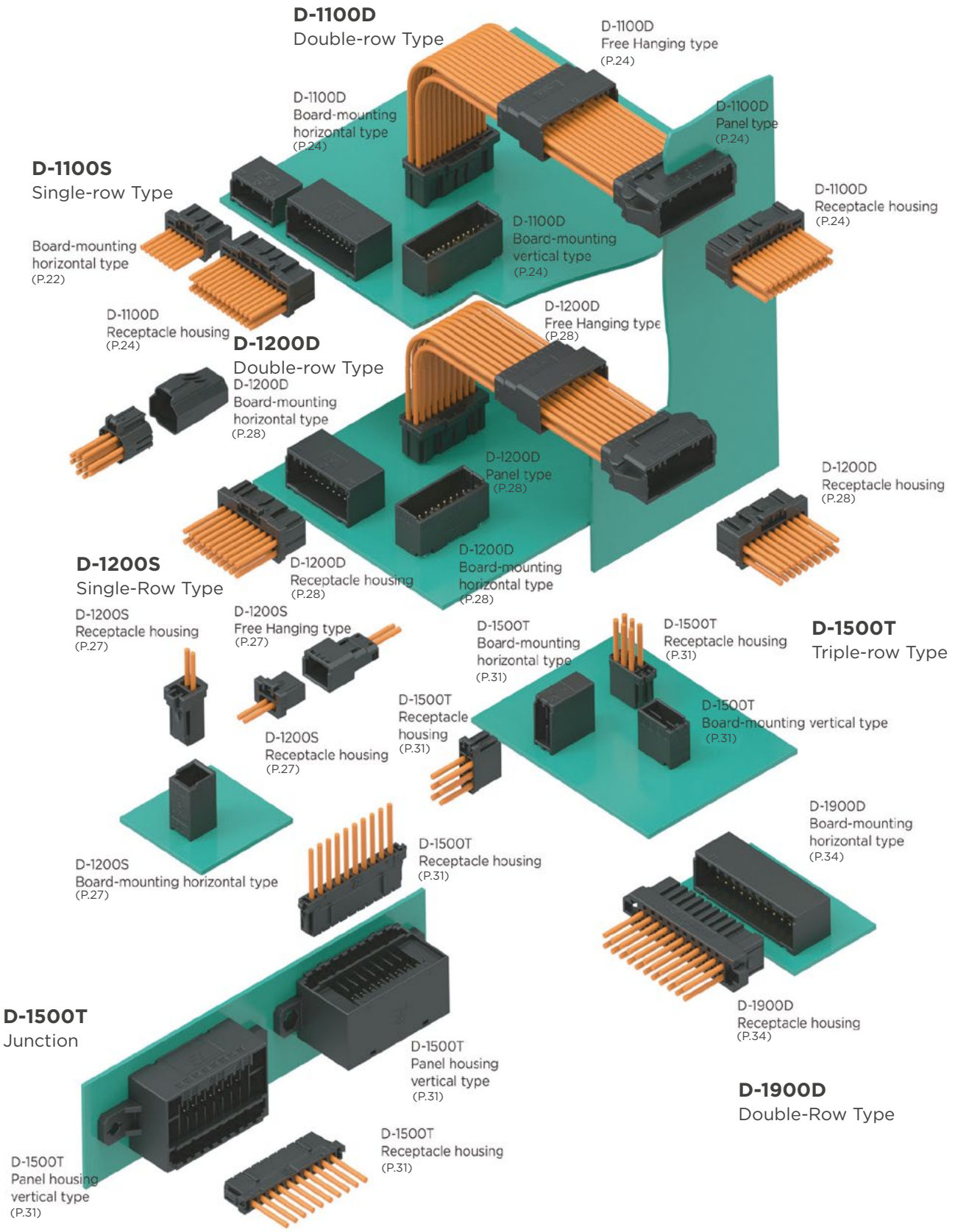

D-1000 Series Contact

Crimp Contacts

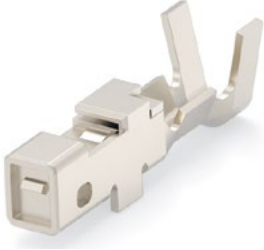

Receptacle Contact
(for Receptacle housing)

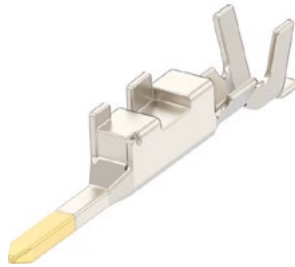

Tab contact
(for Tab housing)

Wire range				Plating	Receptacle Contact		TAB Contact		Application Toolings	
AWG	mm ²	Outer diameter of insulation mm	Wire Range mark		Strip Form	Loose Piece	Strip Form	Loose Piece	CCII hand tool PEW12 hand tool* (PEW12 dies Only)	Mini Applicator
30 28	0.05 0.10	0.6-1.2	S	15µ" [0.38µm] Gold	1827569-2	1827586-2	1903111-2	1903115-2	2119144-1 1762952-1* (1762453-1)	2114042-2
				8µ" [0.20µm] Gold	1827569-4	1827586-4	1903111-4	1903115-4		
				Tin	—	—	—	—		
28 26 24 22	0.05 0.10 0.20 0.37	1.08-1.6	M	15µ" [0.38µm] Gold	1827570-2	1827587-2	1903112-2	1903116-2	2119141-1 1762846-1* (1762847-1)	2151082-1
				8µ" [0.20µm] Gold	1827570-4	1827587-4	1903112-4	1903116-4		
				Tin	1871303-1	1871743-1	1903120-1	1903124-1		
28 26 24 22	0.05 0.10 0.20 0.37	1.08-1.9	L	15µ" [0.38µm] Gold	1827571-2	1827588-2	1903113-2	1903117-2	2119143-1 1762950-1* (1762951-1)	2114043-2
				8µ" [0.20µm] Gold	1827571-4	1827588-4	1903113-4	1903117-4		
				Tin	1871304-1	1871744-1	1903121-1	1903125-1		
22 20 18	0.34-0.37 0.51-0.53 0.85-0.87	1.4-2.2	2L	15µ" [0.38µm] Gold	1827572-2	1827589-2	1903114-2	1903118-2	2119142-1 1762625-1* (1762626-1)	2151083-1
				8µ" [0.20µm] Gold	1827572-4	1827589-4	1903114-4	1903118-4		
				Tin	1871731-1	1871745-1	1903122-1	1903126-1		

Remarks:

The contacts L and 2L do not fit into the D-1100 receptacle housing and tab housing.

When ordering, specify your requirements by multiplying the quality.

Contact our Sales Department for more information.

Gold plating: 0.38µm or 0.20µm

Tin plating: 2.0µm

For mini-applicators information, contact our Sales Department.

Keying plug: 1939588-1

Strip Form contacts are used with Mini-applicators (bench machine) and Loose-Piece contacts are with hand tools.

*With die set

Keying Plug with flip locator use CCII hand tools (CERT®CRIMPII)

PEW12 dies are interchangeable hand tools.

* Only hand tools are available with dies, part number 9-147824D-0

Receptacle contacts are only available for receptacle housings, while the Tab housings are only available for tab housings. Refer to pages P.121-125 for details of applicable tools.

D1100S Single-row Standard Types – 2mm pin pitch

Type Chart

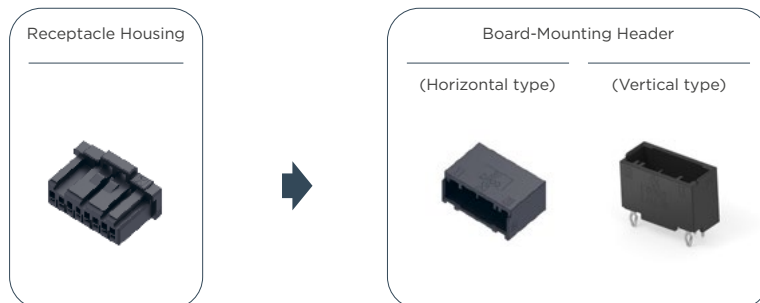

POS	Color	Key	Receptacle housing	Board-Mounting Header		
				Plating	Horizontal type	Vertical type
4	Black	X	1-1939758-4	Gold	1-1939760-4	1-2394617-4
				Tin	1-1939761-4	1-2390471-4
	Black	Y	2-1939758-4	Gold	2-1939760-4	2-2394617-4
				Tin	—	2-2390471-4
8	Black	X	1-1939758-8	Gold	1-1939760-8	1-2394617-8
				Tin	—	1-2390471-8
	Black	Y	2-1939758-8	Gold	2-1939760-8	2-2394617-8
				Tin	—	2-2390471-8
10	Black	X	1-1939758-0	Gold	1-1939760-0	1-2394617-0
				Tin	1-1939761-0	1-2390471-0
	Black	Y	2-1939758-0	Gold	2-1939760-0	2-2394617-0
				Tin	—	2-2390471-0
12	Black	X	1-1939758-1	Tin	—	1-2390471-1
16	Black	X	1-1939758-3	Gold	—	1-2394617-3
				Tin	1-1939761-3	1-2390471-3
		Y	2-1939758-3	Gold	—	2-2394617-3
				Tin	2-1939761-3	2-2390471-3

Relative Product Information

Applicable contact ...P.21

Performance & Specifications ...P.19

Mated Dimensions

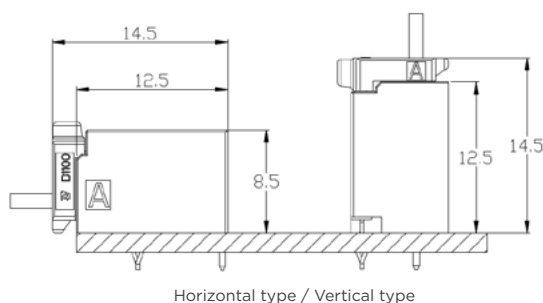

Dimensions are in mm

Note: All Part Numbers are RoHS compliant.

D1100S Single-row Standard Types – 2mm pin pitch

External Dimensions

- Receptacle Housing

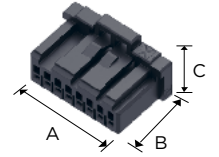

POS	Color	Key	Receptacle housing	Dimensions		
				A	B	C
4	Black	X	1-1939758-4	8.9	11.3	9.15
	Black	Y	2-1939758-4			
8	Black	X	1-1939758-8	16.9		
	Black	Y	2-1939758-8			
10	Black	X	1-1939758-0	20.9		
	Black	Y	2-1939758-0			
12	Black	X	1-1939758-1	24.9		
	Black	Y	2-1939758-1			
16	Black	X	1-1939758-3	32.9		
	Black	Y	2-1939758-3			

- Board-Mounting Header

Horizontal type

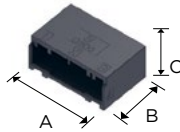

Vertical type

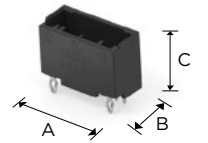

POS	Color	Key	Plating	Part Number	Dimensions		
					A	B	C
4	Black	X	Gold	1-1939760-4	10.6	12.5	8.5
	Black		Tin	1-1939761-4			
	Black	Y	Gold	2-1939760-4			
	Black		Tin	2-1939761-4			
8	Black	X	Gold	1-1939760-8	18.6	12.5	8.5
	Black		Tin	—			
	Black	Y	Gold	2-1939760-8			
	Black		Tin	—			
10	Black	X	Gold	1-1939760-0	22.6	12.5	8.5
	Black		Tin	1-1939761-0			
	Black	Y	Gold	2-1939760-0			
	Black		Tin	2-1939761-0			
12	Black	X	Tin	—	—	—	—
	Black	Y	Tin	—	—	—	—
16	Black	X	Tin	1-1939761-3	34.6	12.5	8.5
	Black	Y	Tin	2-1939761-3			

POS	Color	Key	Plating	Part Number	Dimensions		
					A	B	C
4	Black	X	Gold	1-2394617-4	10.6	8.0	12.5
	Black		Tin	1-2390471-4			
	Black	Y	Gold	2-2394617-4			
	Black		Tin	—			
8	Black	X	Gold	1-2394617-8	18.6	8.0	12.5
	Black		Tin	1-2390471-8			
	Black	Y	Gold	2-2394617-8			
	Black		Tin	2-2390471-8			
10	Black	X	Gold	1-2394617-0	22.6	8.0	12.5
	Black		Tin	1-2390471-0			
	Black	Y	Gold	2-2394617-0			
	Black		Tin	—			
12	Black	X	Tin	1-2390471-1	26.6	8.0	12.5
16	Black	X	Gold	1-2394617-3	34.6	8.0	12.5
			Tin	1-2390471-3			
		Y	Gold	2-2394617-3			
			Tin	2-2390471-3			

Note: All Part Numbers are RoHS compliant.

D-1100D Double-row Standard Types - 2mm pin pitch

Type Chart

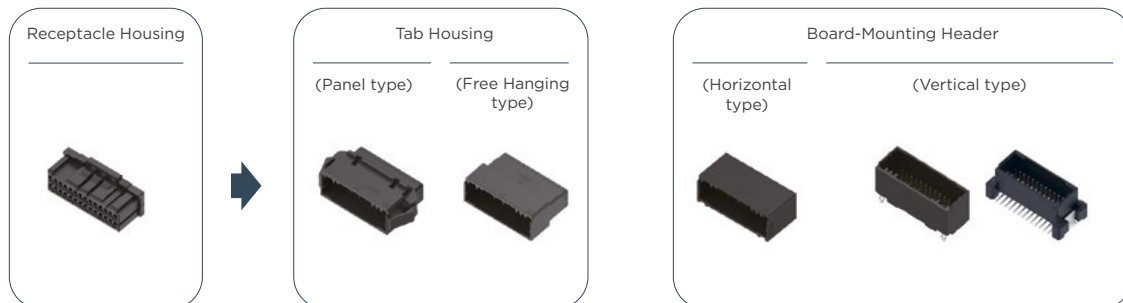

POS	Color	Key	Receptacle Housing		Tab Housing		Board-Mounting Header				
			Standard	High-retention force	Panel type	Free hanging type	Plating	Horizontal type	Vertical type		
								THT	THT	Reflow/THR	Reflow/SMT
10	Black	X	1-1827862-5 9-1827862-5*	1-2333149-5	1-2069681-5	1-2069682-5	Gold	1-1827873-5	1-2040516-5	—	—
							Tin	1-2271887-5	1-2341421-5	—	—
18	Black	X	1-1827862-9	—	—	—	Gold	—	1-2040516-9	—	—
							Tin	—	1-2341421-9	—	—
20	Black	X	1-1827862-0	1-2333149-0	—	—	Gold	1-1827873-0	1-2040516-0	—	—
							Tin	1-2271887-0	1-1554590-0	—	—
22	Black	X	1-1827863-1	1-2333134-1	1-1903128-1	1-1903127-1	Gold	—	1-1827872-1	—	—
							Tin	—	1-1871315-1	—	—
24	Black	X	1-1827863-2	1-2333134-2	—	—	Gold	—	1-1827872-2	1-2429955-2	—
							Tin	—	1-1871315-2	—	—
	Black	Y	2-1827863-2	—	—	—	Gold	—	—	2-2429955-2	—
26	Black	X	1-1827863-3	1-2333134-3	1-1903128-3	1-1903127-3 1-2468186-3*	Gold	1-1939638-3	1-1827872-3	—	1-1939995-3 1-2339471-3
							Tin	1-2372488-3	1-1871315-3	—	—
	Black	Y	2-1827863-3	—	—	—	Gold	—	—	—	2-1939995-3
28	Black	X	1-1827863-4	1-2333134-4	1-1903128-4	1-1903127-4	Gold	1-1939638-4	1-1827872-4	—	—
							Tin	1-2372488-4	1-1871315-4	—	—
30	Black	X	1-1827863-5	1-2333134-5	—	—	Gold	1-1939638-5	1-1827872-5	—	—
							Tin	1-2372488-5	1-1871315-5	—	—
32	Black	X	1-1827863-6	1-2333134-6	1-1903128-6	1-1903127-6	Gold	—	1-1827872-6	—	—
							Tin	—	1-1871315-6	—	—
34	Black	X	1-1827863-7	1-2333134-7	1-1903128-7	1-1903127-7	Gold	1-1939638-7	1-1827872-7	—	—
							Tin	1-2372488-7	1-1871315-7	—	—
	Black	Y	2-1827863-7	—	—	—	Gold	—	2-1827872-7	—	—
							Tin	—	2-1871315-7	—	—
40	Black	X	1-1827863-0	1-2333134-0	1-1903128-0 1-2350416-0*	1-1903127-0	Gold	1-1939638-0	1-1827872-0	—	1-1939995-0
							Tin	1-2372488-0	1-1871315-0	—	—
	Black	Y	2-1827863-0	—	—	—	Gold	—	2-1827872-0	—	2-1939995-0

* latch-protected product with different locking heights.

Relative Product Information

Applicable contact ...P.21

Performance & Specifications ...P.19

Note: All Part Numbers are RoHS compliant.

D-1100D Double-Row Standard Types — 2mm pin pitch

Mated Dimension

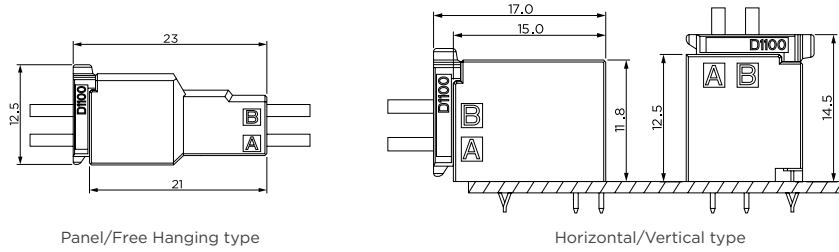

Dimensions are in mm

External Dimensions

- Receptacle Housing

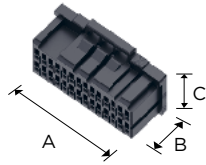

Pos	Key	Color	Part Number	Dimensions		
				A	B	C
10	X	Black	1-1827862-5	12.6	11.3	12.5
			1-2333149-5			
18	X	Black	1-1827862-9	20.6	11.3	12.5
20	X	Black	1-1827862-0	22.6		
			1-2333149-0			
22	X	Black	1-1827863-1	24.6	11.3	12.5
			1-2333134-1			
24	X	Black	1-1827863-2	26.6	11.3	12.5
			1-2333134-2			
26	X	Black	1-1827863-3	28.6	11.3	12.5
	Y	Black	2-1827863-3			
28	X	Black	1-1827863-4	30.6	11.3	12.5
			1-2333134-4			
30	X	Black	1-1827863-5	32.6	11.3	12.5
			1-2333134-5			
32	X	Black	1-1827863-6	34.6	11.3	12.5
			1-2333134-6			
34	X	Black	1-1827863-7	36.6	11.3	12.5
	Y	Black	2-1827863-7			
40	X	Black	1-1827863-0	42.6	11.3	12.5
	Y	Black	1-1827863-0			

- Tab housing

Panel type

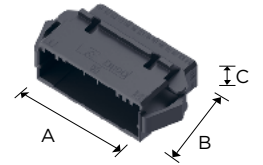

Pos	Key	Color	Part Number	Dimensions		
				A	B	C
10	X	Black	1-2069681-5	22.1	21.0	13.9
22	X	Black	1-1903128-1	34.1		
26	X	Black	1-1903128-3	38.1	21.0	13.9
28	X	Black	1-1903128-4	40.1		
32	X	Black	1-1903128-6	44.1	21.0	13.9
34	X	Black	1-1903128-7	46.1		
40	X	Black	1-1903128-0	52.1	21.0	13.9

Free Hanging type

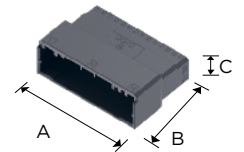

Pos	Key	Color	Part Number	Dimensions		
				A	B	C
10	X	Black	1-2069682-5	12.6	21.0	11.3
22	X	Black	1-1903127-1	24.6		
26	X	Black	1-1903127-3	28.6	21.0	11.3
28	X	Black	1-1903127-4	30.6		
32	X	Black	1-1903127-6	34.6	21.0	11.3
34	X	Black	1-1903127-7	36.6		
40	X	Black	1-1903127-0	42.6	21.0	11.3

Note: All Part Numbers are RoHS compliant.

D-1100D Double row Standard Types – 2mm pin pitch

Board-Mounting Header

Horizontal type

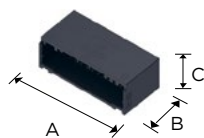

Pos	Color	Key	Plating	Part Number	Dimensions		
					A	B	C
10	Black	X	Gold	1-1827873-5	12.6	15.0	11.8
			Tin	1-2271887-5			
20	Black	X	Gold	1-1827873-0	22.6	15.0	11.8
			Tin	1-2379284-0			
26	Black	X	Gold	1-1939638-3	28.6	15.0	11.8
			Tin	1-2372488-3			
28	Black	X	Gold	1-1939638-4	30.6	15.0	11.8
			Tin	1-2372488-4			
30	Black	X	Gold	1-1939638-5	32.6	15.0	11.8
			Tin	1-2372488-5			
34	Black	X	Gold	1-1939638-7	36.6	15.0	11.8
			Tin	1-2372488-7			
40	Black	X	Gold	1-1939638-0	42.6	15.0	11.8
			Tin	1-2372488-0			

Vertical type

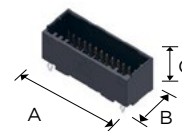

Pos	Color	Key	Plating	Part Number	Dimensions		
					A	B	C
10	Black	X	Gold	1-2040516-5	12.6	11.3	12.5
	Black		Tin	1-2341421-5			
18	Black	X	Gold	1-2040516-9	20.6	11.3	12.5
	Black		Tin	1-2341421-9			
20	Black	X	Gold	1-2040516-0	22.6	11.3	12.5
	Black		Tin	1-1554590-0			
	Black		Tin	1-2341421-0			
22	Black	X	Gold	1-1827872-1	24.6	11.3	12.5
	Black		Tin	1-1871315-1			
24	Black	X	Gold	1-1827872-2	26.6	11.3	12.5
	Black		Tin	1-2429955-2			
	Black		Tin	1-1871315-2			
26	Black	X	Gold	2-2429955-2	28.6	11.3	12.5
	Black		Tin	1-1827872-3			
28	Black	X	Gold	1-1827872-4	30.6	11.3	12.5
	Black		Tin	1-1871315-3			
30	Black	X	Gold	1-1827872-5	32.6	11.3	12.5
	Black		Tin	1-1871315-4			
32	Black	X	Gold	1-1827872-6	34.6	11.3	12.5
	Black		Tin	1-1871315-5			
34	Black	X	Gold	1-1827872-7	36.6	11.3	12.5
	Black		Tin	1-1871315-6			
	Black	Y	Gold	2-1827872-7			
40	Black	X	Gold	1-1827872-0	42.6	11.3	12.5
	Black		Tin	1-1871315-7			
	Black	Y	Gold	2-1827872-0			

SMT

Board-Mounting Header

Vertical type

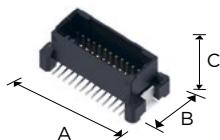

Pos	Color	Key	Plating	Part Number	Dimensions		
					A	B	C
26	Black	X	Gold	1-1939995-3	34.6	16.3	13.5
	Black			1-2339471-3*			
	Black	Y		2-1939995-3			
40	Black	X	Gold	1-1939995-0	48.6	16.3	13.5
	Black	Y	Gold	2-1939995-0			

* Packaging form: emboss.

Note: All Part Numbers are RoHS compliant.

D-1200S Single Row/High Voltage Types – 2.5mm pin pitch

Type Chart

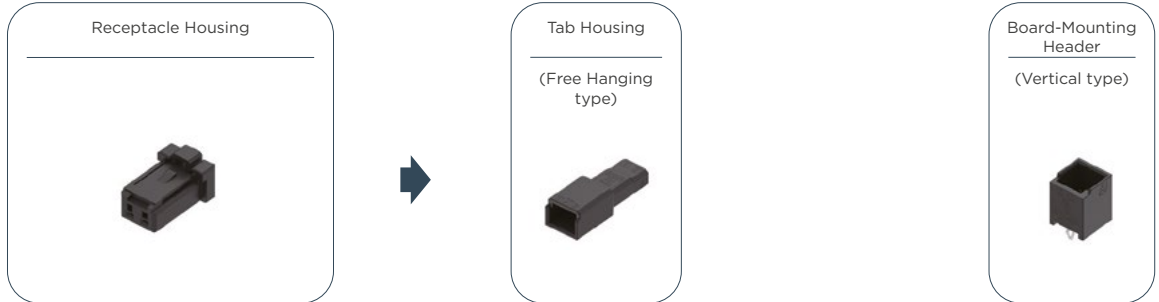

POS	Color	Key	Receptacle housing		Tab housing		Board-Mounting Header		
			Standard	High-retention force	Panel type	Free hanging type	Plating	Horizontal type	Vertical type
2	Black	X	1-1871465-2	1-2443800-2	—	1-1903129-2	Gold	—	1-1871468-2
							Tin	—	1-2348456-2

Relative Product Information

Applicable contact ...P.21
Performance & Specifications ...P.19

Mated Dimension

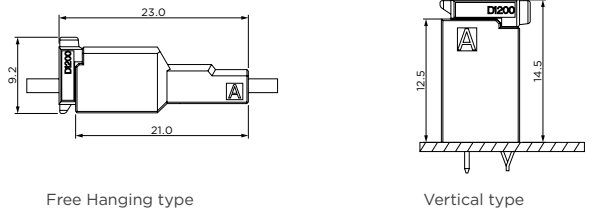

External Dimensions

- Receptacle Housing

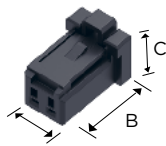

Pos	Key	Color	Part Number	Dimensions		
				A	B	C
2	X	Black	1-1871465-2	7.6	11.3	9.2
			1-2443800-2			

- Tab Housing

Free Hanging type

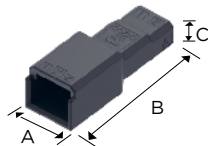

Pos	Key	Color	Part Number	Dimensions		
				A	B	C
2	X	Black	1-1903129-2	7.6	21.0	8.0

- Board-Mounting Header

Vertical type

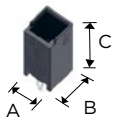

Pos	Key	Plating	Color	Part Number	Dimensions		
					A	B	C
2	X	Gold	Black	1-1871468-2	7.6	8.0	12.5
		Tin		1-2348456-2			

D-1200D Double Row High Voltage Types – 2.5mm pin pitch

Type Chart

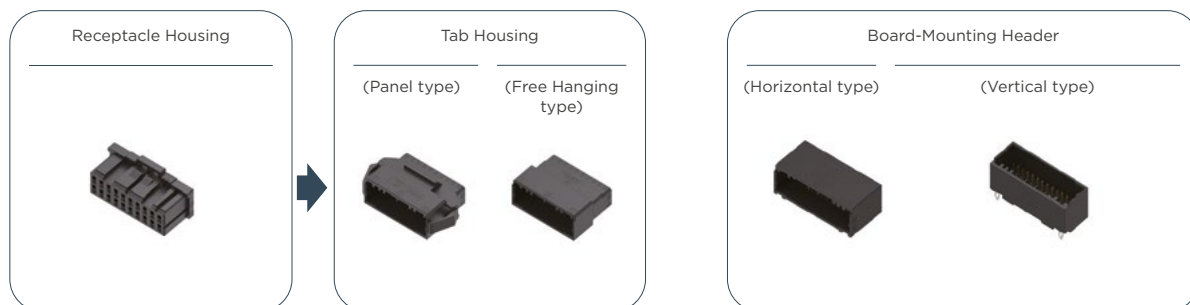

POS	Color	Key	Receptacle housing			Tab housing		Plating	Board-Mounting Header		
			Standard	latch-protected	High-retention force	Panel type	Free hanging type		Horizontal type		Vertical type
									Standard	Standard	Vertical Reflow/THR
4	Black	X	1-1827864-2	9-1827864-2	1-2349949-2	1-1903131-2	1-1903130-2	Gold	1-1827876-2	1-1827875-2	1-2429946-2
	Black	Y	2-1827864-2	—	—	—	—	Tin	1-2348455-2	1-2348454-2	—
6	Black	X	1-1827864-3	9-1827864-3	—	1-1903131-3	1-1903130-3	Gold	1-1827876-3	1-1827875-3	1-2429946-3
	Black	Y	2-1827864-3	—	—	2-1903131-3	2-1903130-3	Tin	1-2348455-3	1-2348454-3	—
8	Black	X	1-1827864-4	9-1827864-4**	1-2349949-4	1-1903131-4	1-1903130-4	Gold	1-1827876-4	1-1827875-4	1-2429946-4
	Black	Y	2-1827864-4	—	—	2-1903131-4	2-1903130-4	Tin	1-2348455-4	1-2348454-4	—
10	Black	X	1-1827864-5	—	—	—	—	Gold	1-1827876-5	1-1827875-5	—
	Black	Y	2-1827864-5	—	—	—	—	Tin	—	1-2348454-5	—
12	Black	X	1-1827864-6	9-1827864-6	1-2349949-6	1-1903131-6	1-1903130-6 1-2468187-6*	Gold	1-1827876-6	1-1827875-6	—
	Black	Y	2-1827864-6	—	2-2349949-6	2-1903131-6	2-1903130-6 2-2468187-6*	Tin	1-2348455-6	1-2348454-6	—
16	Black	X	1-1827864-8	—	—	—	—	Gold	1-1827876-8	1-1827875-8	—
	Black	Y	2-1827864-8	—	—	—	—	Tin	—	1-2348454-8	—
20	Black	X	1-1827864-0	9-1827864-0**	1-2349949-0	1-1903131-0	1-1903130-0	Gold	1-1827876-0	1-1827875-0	—
	Black	Y	2-1827864-0	—	—	2-1903131-0	2-1903130-0	Tin	1-2348455-0	1-2348454-0	—

* The product marked with "*" is high-retention force version of receptacle housing.
** Preliminary to release

Relative Product Information

Applicable contact ...P.21

Performance & Specifications ...P.19

D-1200D Double-row High-voltage Types - 2.5mm pin pitch

Mated Dimension

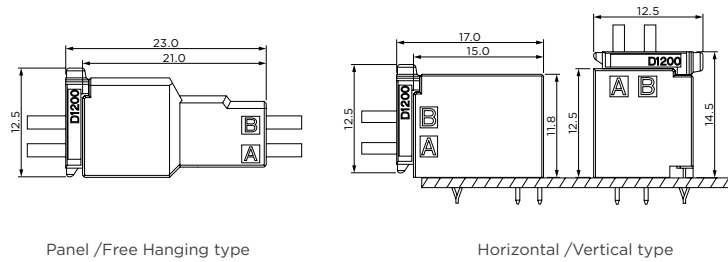

Panel /Free Hanging type

Horizontal /Vertical type

External Dimensions

- Receptacle Housing

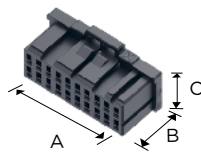

- Tab Housing

Panel type

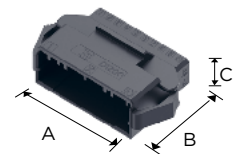

POS	Color	Key	Part Number	Dimensions		
				A	B	C
4	Black	X	1-1827864-2	7.6	11.3	12.5
	Black		9-1827864-2*			12.7
	Black		1-2349949-2**			12.5
	Black	Y	2-1827864-2			12.5
6	Black	X	1-1827864-3	10.1		12.5
	Black		9-1827864-3*			12.7
	Black	Y	2-1827864-3			12.5
8	Black	X	1-1827864-4	12.6		12.5
	Black		9-1827864-4*			12.7
	Black		1-2349949-4**			12.5
	Black	Y	2-1827864-4			12.5
10	Black	X	1-1827864-5	15.1		12.5
	Black	Y	2-1827864-5		12.5	
12	Black	X	1-1827864-6	17.6	12.5	
	Black		9-1827864-6*		12.7	
	Black		1-2349949-6**		12.5	
	Black	Y	2-1827864-6		12.5	
16	Black	X	1-1827864-8	22.6	12.5	
	Black		Y		2-1827864-8	12.5
	Black	X	1-1827864-0		27.6	12.5
	Black		9-1827864-0*			12.7
20	Black	Y	1-2349949-0**	12.5		
	Black		2-1827864-0	12.5		

POS	Color	Key	Part Number	Dimensions		
				A	B	C
4	Black	X	1-1903131-2	17.1	21.0	13.9
6	Black	X	1-1903131-3	19.6	21.0	
		Y	2-1903131-3			
8	Black	X	1-1903131-4	22.1	21.0	
		Y	2-1903131-4			
12	Black	X	1-1903131-6	27.1	21.0	
		Y	2-1903131-6			
20	Black	X	1-1903131-0	37.1	21.0	
		Y	2-1903131-0			

Free Hanging type

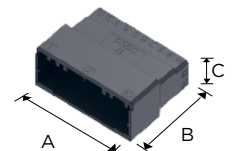

- The product marked with "*" is protective latch version. 8pos and 20pos are in preliminary to release.
- The product marked with "**" is high-retention force version of receptacle housing

POS	Color	Key	Part Number	Dimensions		
				A	B	C
4	Black	X	1-1903130-2	7.6	21.0	11.3
6	Black	X	1-1903130-3	10.1		
		Y	2-1903130-3			
8	Black	X	1-1903130-4	12.6		
		Y	2-1903130-4			
12	Black	X	1-1903130-6	17.6		
			1-2468187-6*			
		Y	2-1903130-6			
20	Black	Y	2-2468187-6*	27.6		
			1-1903130-0			
			2-1903130-0			

* The product marked with "*" is high-retention force version of Tab housing



Standard products:
6P; key X:
1-1827864-3



Products with protective
latches: 6P; key X:
9-1827864-3

Note: All Part Numbers are RoHS compliant.

D-1200D Double Row High Voltage Types – 2.5mm pin pitch

Board-Mounting Header

Horizontal type

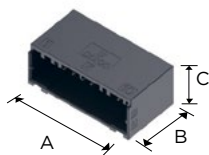

POS	Color	Key	Plating	Part Number	Dimensions		
					A	B	C
4	Black	X	Gold	1-1827876-2	7.6	15.0	11.8
	Black		Tin	1-2348455-2			
	Black	Y	Gold	2-1827876-2			
6	Black	X	Gold	1-1827876-3	10.1		
	Black		Tin	1-2348455-3			
	Black	Y	Gold	2-1827876-3			
8	Black	X	Gold	1-1827876-4	12.6		
	Black		Tin	1-2348455-4			
10	Black	X	Gold	1-1827876-5	15.1		
	Black		Y	Gold			
12	Black	X	Gold	1-1827876-6	17.6		
	Black		Tin	1-2348455-6			
16	Black	X	Gold	1-1827876-8	22.6		
	Black		Y	Gold		2-1827876-8	
	Black		Y	Gold		2-1827876-0	
20	Black	X	Gold	1-1827876-0	27.6		
	Black		Tin	1-2348455-0			
	Black		Y	Gold		2-1827876-0	

Board-Mounting Header

Vertical type

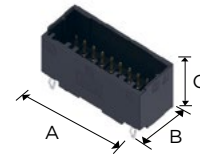

POS	Color	Key	Plating	Part Number	Dimensions		
					A	B	C
4	Black	X	Gold	1-1827875-2	7.6	11.3	12.6
			Tin	1-2429946-2*			
			Tin	1-2348454-2			
6	Black	X	Gold	1-1827875-3	10.1		
			Tin	1-2429946-3*			
			Tin	1-2348454-3			
8	Black	X	Gold	1-1827875-4	12.6		
			Tin	1-2429946-4*			
			Tin	1-2348454-4			
10	Black	X	Gold	1-1827875-5	15.1		
			Tin	1-2348454-5			
			Tin	1-2348454-5			
12	Black	X	Gold	1-1827875-6	17.6		
			Tin	1-2348454-6			
			Tin	1-2348454-6			
16	Black	X	Gold	1-1827875-8	22.6		
			Tin	1-2348454-8			
			Tin	1-2348454-8			
20	Black	X	Gold	1-1827875-0	27.6		
			Tin	1-2348454-0			
			Tin	1-2348454-0			

* The product marked with "*" is through hole Reflow version.

Fan Motor Water-Proof 3P

Wire-To-Wire

Panel mount type



POS	Color	Plug housing	Cap housing - Panel type	Product Specification
3	Black	2013891-1	2013892-1	108-78519

Note: All Part Numbers are RoHS compliant.

D-1500T Triple-row High-voltage Modular Type – 3.5mm pin pitch

Type Chart

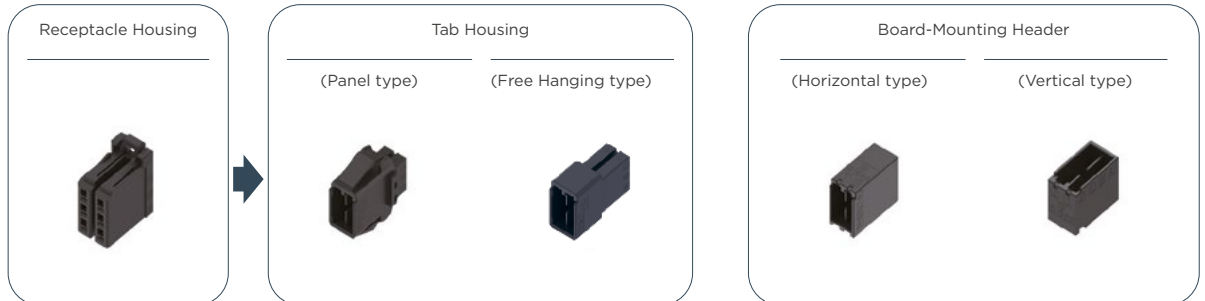

Pos	Color	Key	Receptacle housing	Tab housing		Plating	Board-Mounting Header	
				Panel type	Free Hanging type		Horizontal type	Vertical type
3	Black	X	1-1827579-1	—	1-2040444-1	—	—	1-1827581-1
6	Black	X	1-2069029-2	1-2040404-2	1-2040444-2	Gold	1-1827583-2	1-1827581-2
9	Black	X	1-2069029-3	—	1-2040444-3		—	1-1827581-3
12	Black	X	1-2069029-4	—	1-2040444-4		—	1-1827581-4
36	Black	X	—	3-2040404-2	—		—	—

Relative Product Information

Applicable contact ...P.21

Performance & Specifications ...P.19

Receptacle Housing

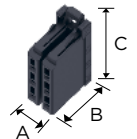

Pos	Key	Color	Part Number	Dimensions		
				A	B	C
3	X	Black	1-1827579-1	3.3	11.3	16.4
6	X	Black	1-2069029-2	6.8		
9	X	Black	1-2069029-3	10.3		
12	X	Black	1-2069029-4	13.8		

Mated Dimension

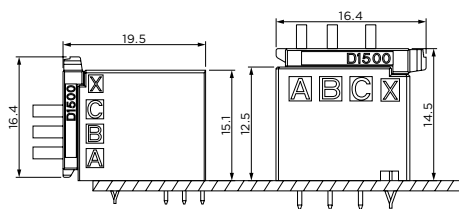

Horizontal /Vertical type

Note: All Part Numbers are RoHS compliant.

D-1500T Triple-row High-voltage Modular Type – 3.5mm pin pitch

External Dimensions

- Tab Housing

Panel type

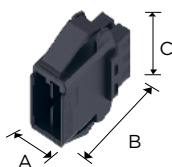

Pos	Key	Color	Part Number	Dimensions		
				A	B	C
6	X	Black	1-2040404-2	8.5	21.0	24.5
36	X	Black	3-2040404-2	43.5		

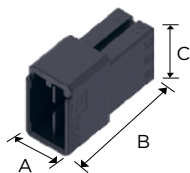

Free Hanging type

Pos	Key	Color	Part Number	Dimensions		
				A	B	C
3	X	Black	1-2040444-1	3.0	21.0	15.0
6	X	Black	1-2040444-2	6.5		
9	X	Black	1-2040444-3	10.0		
12	X	Black	1-2040444-4	13.5		

- Board-Mounting Header

Horizontal type

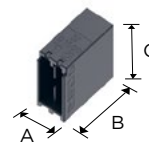

Pos	Key	Plating	Color	Part Number	Dimensions		
					A	B	C
6	X	Gold	Black	1-1827583-2	8.1	17.5	15.1

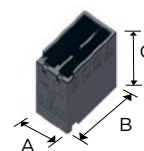

Vertical type

Pos	Key	Plating	Color	Part Number	Dimensions		
					A	B	C
3	X	Gold	Black	1-1827581-1	4.6	14.6	12.5
6	X	Gold	Black	1-1827581-2	8.1		
9	X	Gold	Black	1-1827581-3	11.6		
12	X	Gold	Black	1-1827581-4	15.1		

Note: All Part Numbers are RoHS compliant.

D-1500T Junction Box – 3.5mm pin pitch

Type Chart

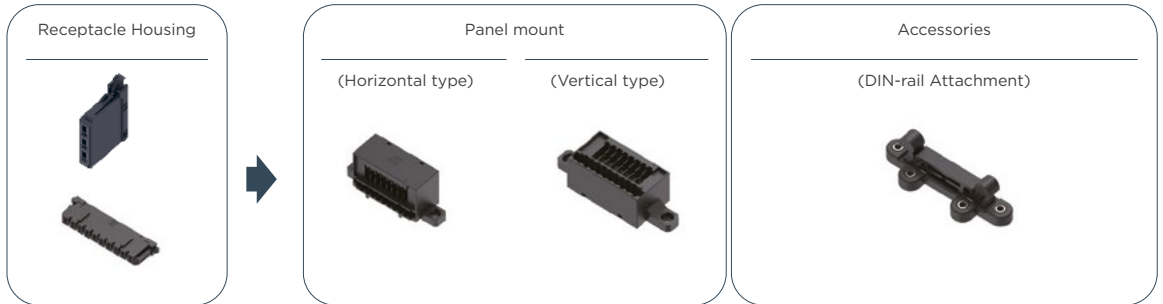

Pos	Color	Key	Receptacle housing	Plating	Panel mount		Accessories
					Horizontal type	Vertical type	DIN-rail attachmentt
3	Black	X	1-1827579-1	—	—	—	—
10	Black	—	1971150-1	—	—	—	—
34	Black	—	—	Gold	1971151-1	1971151-2	1971182-1*

Note: Kit PN 1971190-1 is also available, which includes the junction box 1971151-2, DIN-rail mounting feet 1971182-1 and 2 screws.

* 4 screws are needed for attaching connector into place

Relative Product Information

Applicable contact ...P.21

Performance & Specifications ...P.19

External Dimensions

- Receptacle Housing

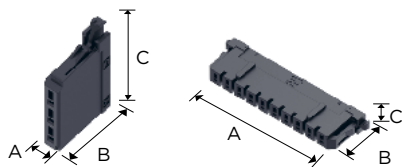

Pos	Key	Color	Part Number	Dimensions		
				A	B	C
3	X	Black	1-1827579-1	3.3	11.3	16.4
10	—	Black	1971150-1	42.2	11.3	4.6

- Panel Mount

Horizontal type

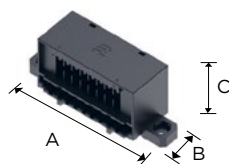

Pos	Key	Plating	Color	Part Number	Dimensions		
					A	B	C
34	—	Gold	Black	1971151-1	57.7	18.7	24.6

Note: All Part Numbers are RoHS compliant.

- Tab Housing

Vertical type

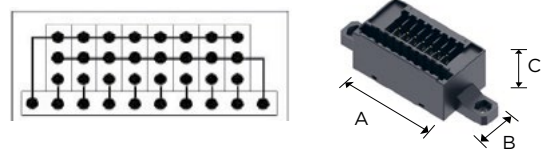

Pos	Key	Plating	Color	Part Number	Dimensions		
					A	B	C
34	—	Gold	Black	1971151-2	64.8	22.8	18.2

- Accessories

Pins to be mounted with a foot attachment

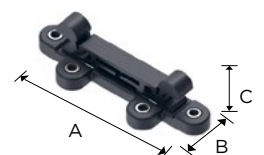

Pos	Key	Color	Part Number	Dimensions		
				A	B	C
—	—	Black	1971182-1	67.5	19.0	18.1

D-1900D Double-row Spring Clamp Type – 3.5mm pin pitch

Type Chart

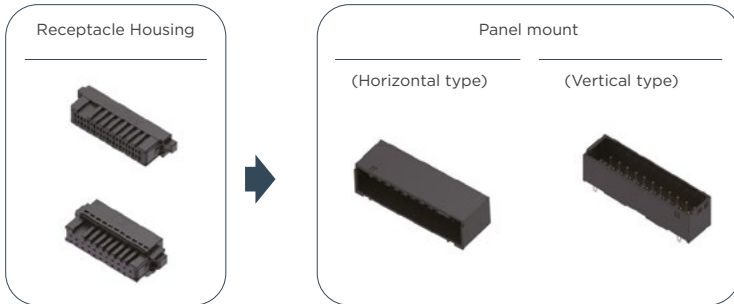

Pos	Color	Key	Receptacle housing	Plating	Panel mount		Accessories
					Horizontal type	Vertical type	
3	Black	X	1-1827579-1	—	—	—	—
10	Black	—	1971150-1	—	—	—	—
34	Black	—	—	Gold	1971151-1	1971151-2	1971182-1*

Note: Kit PN 1971190-1 is also available, which includes the junction box 1971151-2, DIN-rail mounting feet 1971182-1 and 2 screws.
* 4 screws are needed for attaching connector into place

Relative Product Information

Applicable contact ...P.21
Performance & Specifications ...P.19
Special tool 1891348-1

Mated Dimension

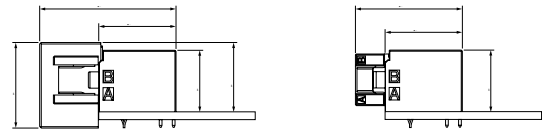

External Dimensions

- Receptacle Housing (Crimp type)

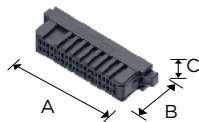

Pos	Key	Color	Part Number	Dimensions		
				A	B	C
8	X	Black	1-1871946-4	24.2	15.0	9.9
12	X	Black	1-1871946-6	34.2		
16	X	Black	1-1871946-8	41.2		
22	X	Black	2-1871946-1	51.7		

- Receptacle Assembly (Spring clamp)

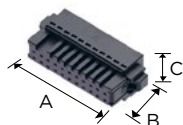

Pos	Key	Plating	Color	Part Number	Dimensions		
					A	B	C
8	X	Gold	Black	1-1871940-4	25.2	20.6	16.4
12	X	Gold	Black	1-1871940-6	32.2		
16	X	Gold	Black	1-1871940-8	39.2		
22	X	Gold	Black	2-1871940-1	49.7		
30	X	Gold	Black	2-1871940-5	63.7		
38	X	Gold	Black	2-1871940-9	77.7		

- Board-Mounting Header

Horizontal type

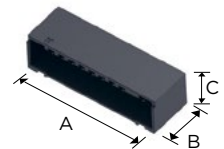

Pos	Key	Plating	Color	Part Number	Dimensions		
					A	B	C
8	X	Gold	Black	1-1871935-4	19.8	14.8	11.8
12	X	Gold	Black	1-1871935-6	26.8		
16	X	Gold	Black	1-1871935-8	33.8		
22	X	Gold	Black	2-1871935-1	44.3		
30	X	Gold	Black	2-1871955-5	58.3		
38	X	Gold	Black	2-1871935-9	72.3		

Vertical type

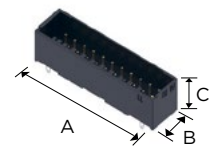

Pos	Key	Plating	Color	Part Number	Dimensions		
					A	B	C
8	X	Gold	Black	1-2013325-4	20.2	11.5	12.5
12	X	Gold	Black	1-2013325-6	26.8		
22	X	Gold	Black	2-2013325-1	44.3		

Note: All Part Numbers are RoHS compliant.

D-2000 Series

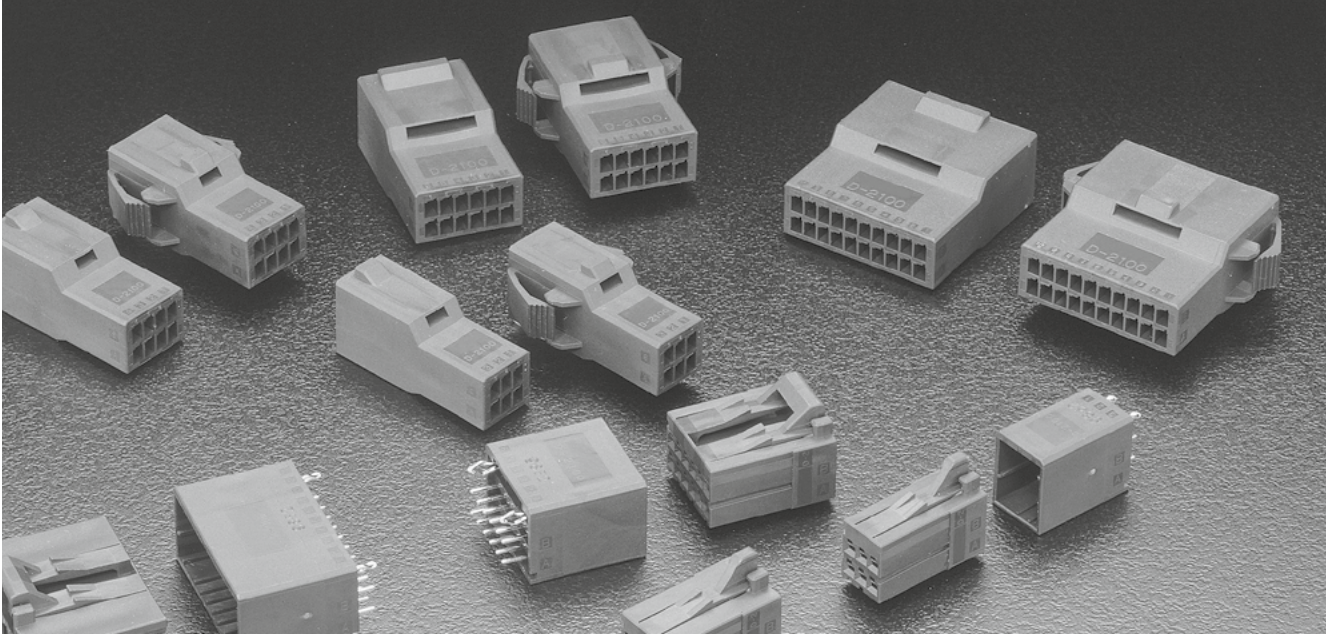

Series Introduction

The D-2000 series is a compact connector in the Dynamic series and has the specifications for industrial machinery. Its proprietary concept, long contact wiping length, provides the high-reliability which is needed for industrial machinery.

The series also includes the multi-position drawer type not found in any other series. The hybrid type integrates signal and power contacts in a single connector.

Product Features

1. Terminal and Housing Construction are Twist Resistant

The box shape receptacle contact is highly resistant to twisting and the housing slit also prevents angled mating to increase reliability.

2. Contact Wiping Length

Attaining the reliability needed for industrial machinery in a compact size by using a long contact wiping length.

3. Wire Sizes:

With its 2.5 mm pitch, it is a compact series, yet it can use 18 AWG wires, which are often used in industrial equipment.

4. Audible Latching

Obvious lock sound and feeling when mating means work can be done without mistakes, such as mismating (halfmating), even if the connection cannot be seen. mating) even in an operating environment where visual inspection is not possible.

5. Keying

The housing is keyed (with a slit), so differentiating between X keys and Y keys prevents mismating. It is also possible to make more key patterns by using keying plugs.

6. Center Locking

This is the first application of a center lock in Dynamic series. On-board space requirements can be minimized because these connectors can be mounted in a tight space for high-density mounting on boards requiring signal lines.

7. Drawer Type

The drawer type connector was developed with a floating construction on one side for applications where it is not possible to see the connection. There can be up to 50 positions, the highest in the series. These connectors make it possible to make connections between units with flexibility.

8. Hybrid Type

The D-2600 series combines signal and power contacts in a single connector by using D-2000 contacts as signal contacts and D-3000 contacts as power ones. This saves on-board space and improves maintenance.

D-2000 Series Performance and Specifications

Performance

Item	2100S/D	2100M	2600D
Pitch	2.5mm		
Rated Current:	5A max	2.6A max	3.2A max
Rated Voltage	250V AC/DC		
Dielectric Withstanding Voltage	1500V AC	2300V AC	1500V AC
Total resistance	5mΩ max (initial) 10mΩ max (lifetime)		
Insertion strength	4.9N max (per pole)		
Withdrawal strength	0.29N min (per pole)		
Durability	500 cycles		
Lock strength	39.2N min	—	98N min

Positions / Wire size / Rated current

D-2100S/D value

Position	Wire Size					
	AWG 18	AWG 20	AWG 22	AWG 24	AWG 26	AWG 28
3	5	4.5	4.3	3.3	2.9	2.3
6	5	4.2	4	2.7	2.5	2
8	4.5	4	3.5	2.5	2.2	1.8
12	4	3.5	3	2.3	1.9	1.5
16	3.2	2.8	2.4	2	1.6	1.2
20	3.2	2.8	2.4	2	1.6	1.2

Product Specification

Series Name	D-2100S/D	D-2100M	D-2600D
Product Specifications	108-5619	108-5659	108-78301
Applications Specifications	114-5258		
Instruction sheet (hand tool)	408-10414 (S)		
	408-8547-1(M)		
Instruction sheet (extraction tool PN)	(1276716-1)411-5900		

Please refer to the standards on P. 43 for the D-3000 contact used in D-2600D
Please refer to the manual when using the product. An e-Catalogue is also available for download from the Internet.

Materials and Plating

Category	Material	Plating
Receptacle Contact Tab Contact	Copper alloys	0.38 μm Gold plating over nickel underplate
Board mount Header	Copper alloys	0.38 μm Gold plating over nickel underplate Tin plating on tail side
Housing	UL94-V-0, thermoplastic PBT with glass fiber	

Safety Standards

The safety specifications listed below are approved on specific part numbers. Please contact our Technical Support Centre to check whether the part numbers you use are approved or not. Keep in mind that there are instances where values differ from those given by Tyco Electronics Specifications.

Standards	series	D-2100 series			D-2100M Drawer Type		
		Rated Voltage	Rated Current	Temperature Range	Rated Voltage	Rated Current	Temperature Range
Product Specifications 108-5619 (general)108-5659 (drawer type)		250V AC/DC	5A (unipolar)	-55°C --+105°C	250V AC/DC	2.6A AWG#20 hours 50 pole load	-5°C --+105°C
ULFile No.E28476		Determined according to the requirements of application	Determined according to the requirements of application	—	Determined according to the requirements of application	Determined according to the requirements of application	—
CSAReport No. LR 7189		250V AC/DC	AWG#24-#28: 3.3A AWG#18-#22: 5A	—	250V AC/DC	Max 5A per pole	—
TÜVLICENSE No. R 9950679		125V AC/DC	5A	-55°C --+105°C	125V AC/DC	Max 5A per pole	-5°C --+105°C

D-2000 Series Configurations

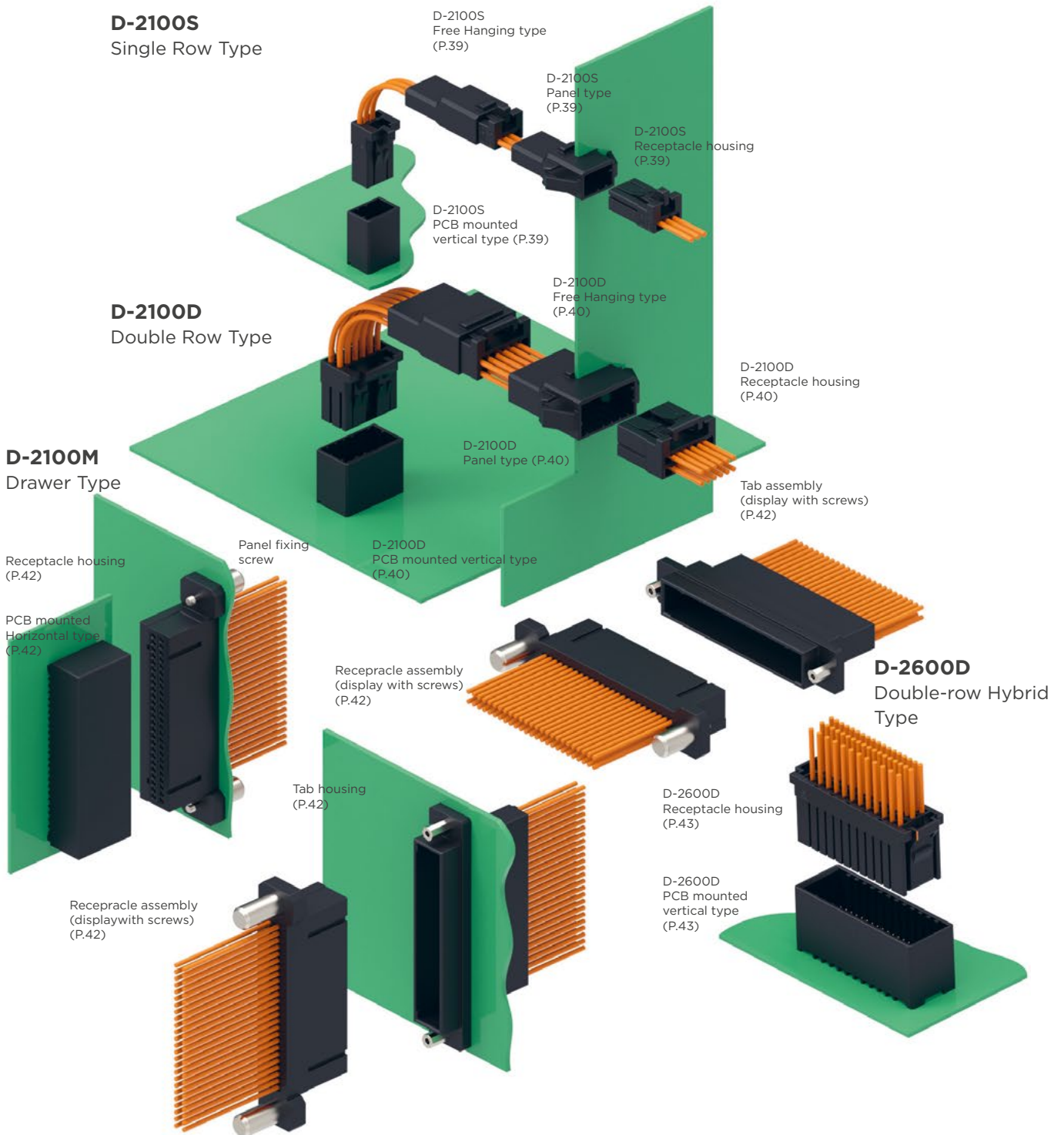

D-2000 Series Contact

Crimped type

(gold plating thicknes 0.38 μm)



Receptacle Contact
(used in receptacle housing)



Tab contact
(used in tab housing)

Wire Range		Outside Diameter of Insulation mm	Wire Range Mark	Contact part number				Models of applicable tools	
AWG	mm ²			Receptacle Contact		Tab Contact		Hand Tools	Tool numbers
				Strip form	Loose Piece	Strip form	Loose Piece		
28	0.09	0.88-1.3	S	1318106-1	1318108-1	1318110-1	1318112-1	91576-1	2151240-1
26	0.12								
24	0.20	1.11-1.43							
24	0.20	2.2-2.25	SI	1-1318106-1*	—	1-1318110-1*	—	—	—
22	0.30	1.26-1.8	M	1318105-1	1318107-1	1318109-1	1318111-1	91595-1	2151071-1
20	0.50								
18	0.85	1.79-1.9							

***This terminal is only applicable to the UL1051 cable.**

Note: When placing your order, please check with the confirmed sales leadtime. Please contact our sales department or distributor for more information.
Strip Form contacts are used with Mini-applicators (bench machine) and Loose-Piece contacts are with hand tools.

Tin plating contact will be available in June.2024

The receptacle contact can be used in all receptacle housings, the Tab housing can be used in all tab housings. Details of the applicable tools are available from P.120-124

D-2100S Single-row Standard Type - 2.5mm pin pitch

Type Chart

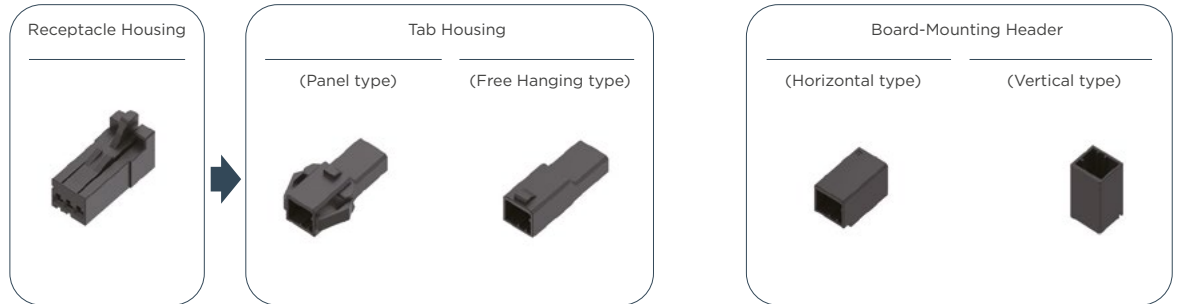

Pos	Color	Key	Receptacle housing	Tab housing		Plating	Board-Mounting Header	
				Panel type	Free Hanging type		Horizontal type	Vertical type
3	Black	X	1-1318120-3	1-1318116-3	1-1318117-3	Gold	1376135-1	1318123-1
	Black	Y	2-1318120-3	2-1318116-3	2-1318117-3	Gold	1376135-2	1318123-2
	Black	Z	3-1318120-3	—	—	Gold	1376135-3	—
	Black	X	1-1473074-3*	—	—	Gold	—	1-1318123-1**

NOTE: The * mark means drawer typer
**Sequential

Relative Product Information

Application contact...P.38
Performance & Specifications...P.36

Mated Dimension

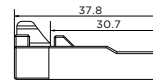

Panel /Free Hanging type

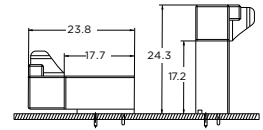

Horizontal type Vertical type

External Dimensions

• Receptacle Housing

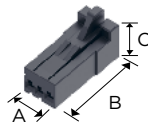

Pos	Key	Color	Part Number	Dimensions		
				A	B	C
3	X	Black	1-1318120-3	8.9	20.0	12.0
	Y	Black	2-1318120-3			
	Z	Black	3-1318120-3			
	X	Black	1-1473074-3			

• Tab Housing

Panel type

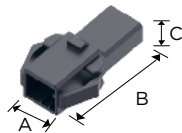

Pos	Key	Color	Part Number	Dimensions		
				A	B	C
3	X	Black	1-1318116-3	19.7	30.7	9.5
	Y	Black	2-1318116-3			

Free Hanging type

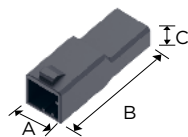

Pos	Key	Color	Part Number	Dimensions		
				A	B	C
3	X	Black	1-1318117-3	10.2	30.7	9.5
	Y	Black	2-1318117-3			

• Board-Mounting Header

Horizontal type

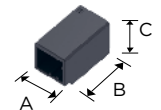

Pos	Key	Plating	Color	Part Number	Dimensions		
					A	B	C
3	X	Gold	Black	1376135-1	10.2	17.7	11.0
	Y	Gold	Black	1376135-2			
	Z	Gold	Black	1376135-3			

Vertical type

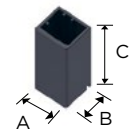

Pos	Key	Plating	Color	Part Number	Dimensions		
					A	B	C
3	X	Gold	Black	1318123-1	10.2	9.5	17.8
		Gold	Black	1-1318123-1**			
	Y	Gold	Black	1318123-2			

**Sequential

NOTE: All products are RoHS compliant On selection.

D-2100D Double-row Standard Type - 2.5mm pin pitch

Type Chart

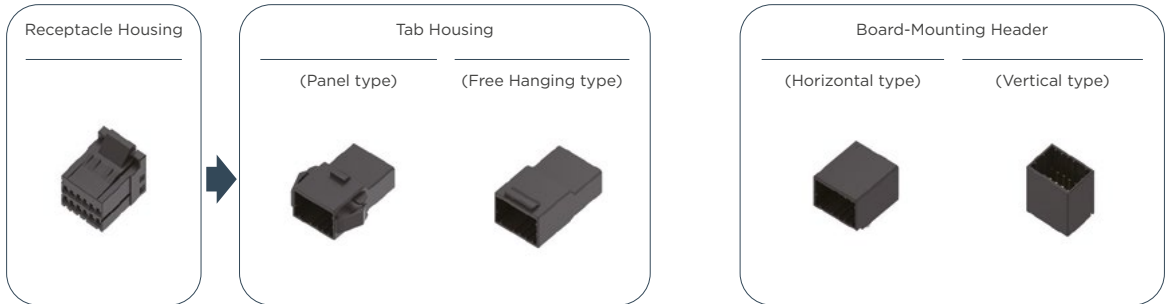

Pos	Color	Key	Receptacle housing	Tab housing		Plating	Board-Mounting Header	
				Panel type	Free Hanging type		Horizontal type	Vertical type
6	Black	X	1-1318119-3	1-1318114-3	1-1318115-3	Gold	1376136-1	1318124-1
	Black	Y	2-1318119-3	2-1318114-3	2-1318115-3	Gold	1376136-2	1318124-2
8	Black	X	1-1318119-4	1-1318114-4	1-1318115-4	Gold	1376009-1	1318125-1
	Gold					1-1376009-1*	1-1318125-1*	
	Black	Y	2-1318119-4	2-1318114-4	2-1318115-4	Gold	1376009-2	1318125-2
	Gold					1-1318125-2*	1-1318125-2*	
12	Black	X	1-1318118-6	1-1318114-6	1-1318115-6	Gold	1376020-1	1318126-1
	Gold					1-1318126-1*		1-1318126-1*
	Black	Y	2-1318118-6	2-1318114-6	—	Gold	1376020-2	1318126-2
	Gold					1-1318126-2*		1-1318126-2*
	Gold					1-1318126-2*		1-1318126-2*
Black	Z	3-1318118-6	—	—	Gold	—	1318126-3	
16	Black	X	1-1318118-8	—	—	Gold	—	1747994-1
	Black	Y	2-1318118-8	—	—	Gold	—	1747994-2
20	Black	X	1-1318118-9	1-1318114-9	1-1318115-9	Gold	1376137-1	1318127-1
	Black	Y	2-1318118-9	2-1318114-9	2-1318115-9	Gold	1376137-2	1318127-2

Note: There is Z-key option in 20-position product, please contact TE sales representative for more information

*Sequential

Relative Product Information

Application contact...P.38

Performance & Specifications...P.36

Mated Dimension

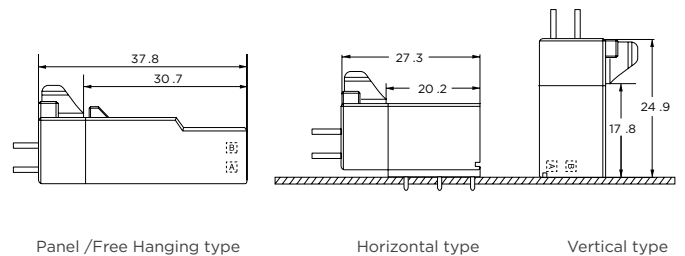

NOTE: All products are RoHS compliant On selection.

D-2100D Double-row Standard Type – 2.5mm pin pitch

External Dimensions

- Receptacle Housing

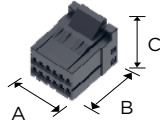

Pos	Key	Color	Part Number	Dimensions		
				A	B	C
6	X	Black	1-1318119-3	8.3	20.0	15.8
	Y	Black	2-1318119-3			
8	X	Black	1-1318119-4	10.8	20.0	15.8
	Y	Black	2-1318119-4			
12	X	Black	1-1318118-6	15.8	20.0	14.8
	Y	Black	2-1318118-6			
	Z	Black	3-1318118-6			
16	X	Black	1-1318118-8	20.8	20.0	14.8
	Y	Black	2-1318118-8			
20	X	Black	1-1318118-9	25.8	20.0	14.8
	Y	Black	2-1318118-9			

- Tab Housing

Panel type

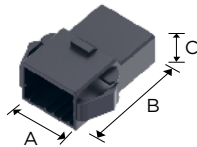

Pos	Key	Color	Part Number	Dimensions		
				A	B	C
6	X	Black	1-1318114-3	19.7	30.7	13.2
	Y	Black	2-1318114-3			
8	X	Black	1-1318114-4	22.2	30.7	13.2
	Y	Black	2-1318114-4			
12	X	Black	1-1318114-6	27.2	30.7	13.2
	Y	Black	2-1318114-6			
20	X	Black	1-1318114-9	37.2	30.7	13.2
	Y	Black	2-1318114-9			

- Tab Housing

Free Hanging type

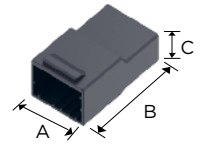

Pos	Key	Plating	Color	Part Number	Dimensions		
					A	B	C
6	X	Gold	Black	1-1318115-3	10.2	30.7	10.7
	Y	Gold	Black	2-1318115-3			
8	X	Gold	Black	1-1318115-4	12.7	30.7	10.7
	Y	Gold	Black	2-1318115-4			
12	X	Gold	Black	1-1318115-6	17.7	30.7	10.7
20	X	Gold	Black	1-1318115-9	27.7	30.7	10.7
	Y	Gold	Black	2-1318115-9			

- Board-Mounting Header

Horizontal type

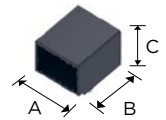

Pos	Key	Plating	Color	Part Number	Dimensions		
					A	B	C
6	X	Gold	Black	1376136-1	10.2	20.2	14.7
	Y	Gold	Black	1376136-2			
8	X	Gold	Black	1376009-11-1376009-1*	12.7	20.2	14.7
	Y	Gold	Black	1376009-2			
12	X	Gold	Black	1376020-1	17.7	20.2	14.7
	Y	Gold	Black	1376020-2			
20	X	Gold	Black	1376137-1	27.7	20.2	14.7
	Y	Gold	Black	1376137-2			

*Sequential

Vertical type

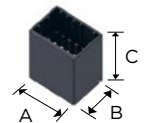

Pos	Key	Plating	Color	Part Number	Dimensions		
					A	B	C
6	X	Gold	Black	1318124-1	10.2	13.2	17.8
	Y	Gold	Black	1318124-2			
8	X	Gold	Black	1318125-11-1318125-1*	12.7	13.2	17.8
	Y	Gold	Black	1318125-21-1318125-2*			
12	X	Gold	Black	1318126-11-1318126-1*	17.7	13.2	17.8
	Y	Gold	Black	1318126-21-1318126-2*			
	Z	Gold	Black	1318126-3			
16	X	Gold	Black	1747994-1	22.7	13.2	17.8
	Y	Gold	Black	1747994-2			
20	X	Gold	Black	1318127-1	27.7	13.2	17.8
	Y	Gold	Black	1318127-2			

*Sequential

NOTE: All products are RoHS compliant On selection.

D-2100M Double-row Standard Multiposition Type (Drawer) - 2.5mm pin pitch

Type Chart

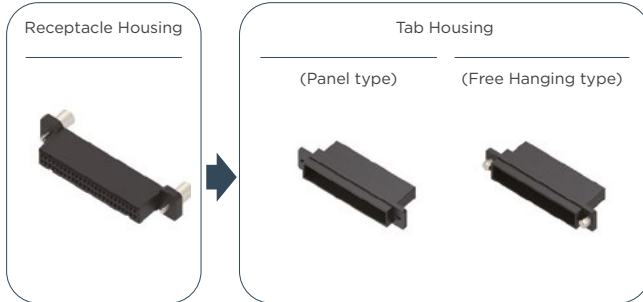

Pos	Color	Key	Receptacle housing		Tab housing		Plating	Board-Mounting Header	
			Type	Part Number	Panel type	Free Hanging type		Horizontal type	Vertical type
50	Black	—	Drawer	1318577-1	1318578-1/1318578-2 (with nuts)	—	Gold	—	—
	Black	—	Threaded rafter	1376072-2	—	1376073-2	—	—	—

Relative Product Information

Application contact...P.38
 Performance & Specifications...P.36
 Accessories ...P.126

Mated Dimension

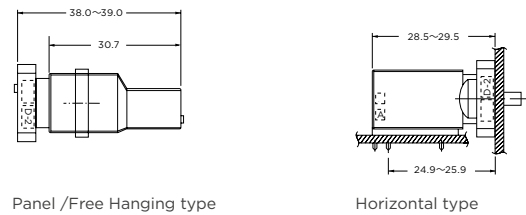

External Dimensions

- Receptacle Housing

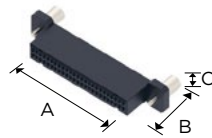

Pos	Key	Color	Part Number	Dimensions		
				A	B	C
50	—	Black	1318577-1	88.5	20.0	16.6
			1376072-2*		32.0	

*The product contains a receptacle housing 1318577-2 and two screws 1376058-1

- Receptacle Assembly (with screws)

Free Hanging type

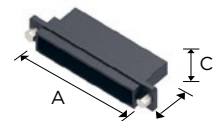

Pos	Key	Color	Part Number	Dimensions		
				A	B	C
50	—	Black	1376073-2	86.1	30.7	15.9

- Tab Housing

Panel type

Pos	Key	Color	Part Number	Dimensions		
				A	B	C
50	—	Black	1318578-1	86.1	30.7	15.9
			1318578-2(with nuts)			

NOTE: All products are RoHS compliant On selection.

D-2600D Double-row Hybrid Type - pin pitch, 2.5mm (D-2), 3.81mm (D-3)

Type Chart

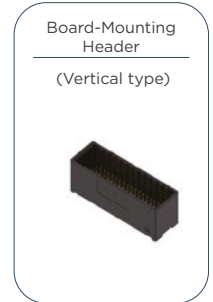

Pos	Color	Key	Receptacle housing	Tab housing		Plating	Board-Mounting Header	
				Panel type	Free Hanging type		Horizontal type	Vertical type
48*	Black	—	1827540-1	—	—	Gold	—	1827538-1

*36 D-2000 contacts and 12 D-3000 contacts are used in combination

Relative Product Information

Applicable contact...P.38,48

Performance & Specifications ...P.36,45

Mated Dimension

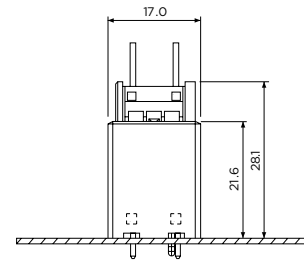

Vertical type

External Dimensions

- Receptacle Housing

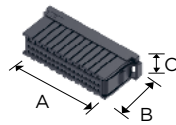

Pos	Key	Plating	Color	Part Number	Dimensions		
					A	B	C
48	—	—	Black	1827540-1	58.7	22.8	15.8

- Board-Mounting Header

Vertical type

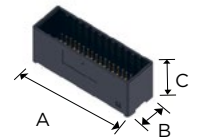

Pos	Key	Plating	Color	Part Number	Dimensions		
					A	B	C
48	—	Gold	Black	1827538-1	55.9	18.0	21.6

D-3000 Series

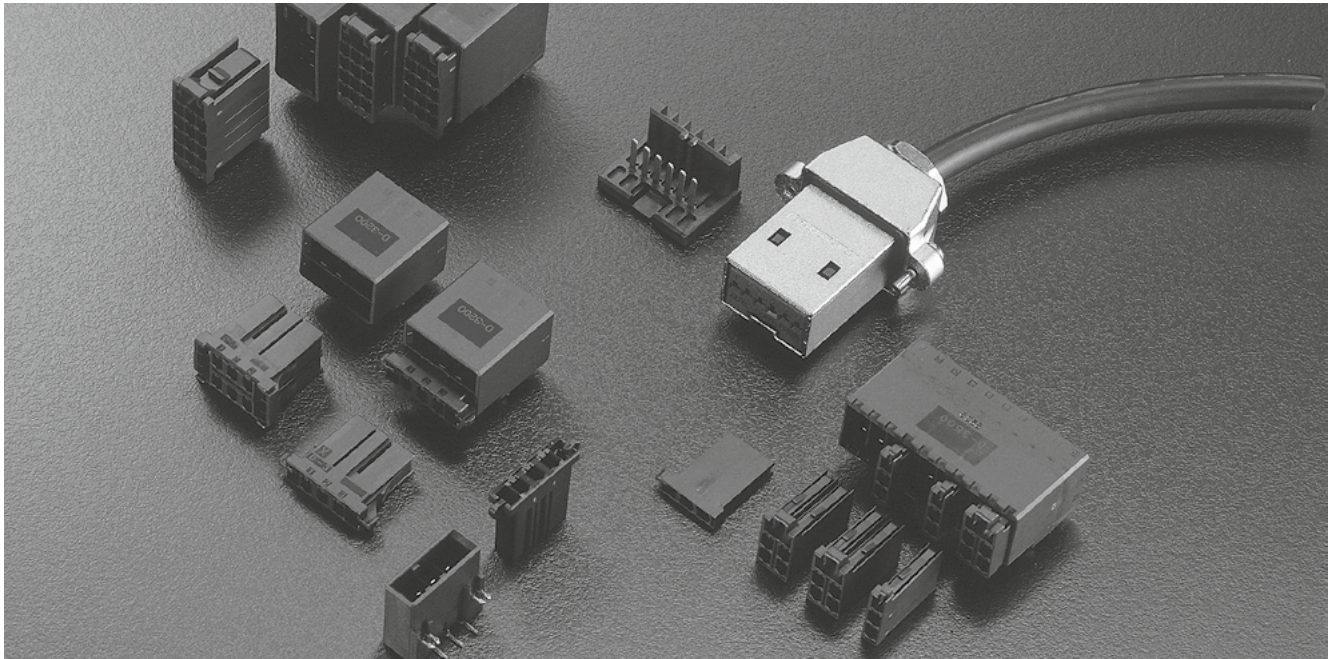

Series introduction

The 3000 series is the main Dynamic Series. They are widely used as industrial 'signal' and 'power' connectors.

Pin layout comes in two types: 3.81mm pitch (standard) and 5.08mm pitch (high voltage). The standard pitch is used for signal circuits and the high voltage type is used for power circuits.

For power source usage, it meets recent demands for small size and high power which comply with miniaturisation of the machinery. The newly developed copper alloy can carry a higher current of 15A per pole despite its small size.

This concept is based on the development strategy of the Dynamic Series to cover as wide a range of solutions for as many customers as possible. This concept makes the D-3000 series terminals fit all D-3000 housings, and the wide variety of which means that it is not necessary for a customer to look outside of this range for every requirement.

The D-3000 series has been in development for more than a decade since its initial development, gaining momentum through customer input, and is currently being extended further.

Product Features

1. Anti-twist contact structure

An anti-twist contact structure were developed for motor industry which has 3 contact points when mating receptacle contact with tab contact or header. Concept of 3-contact-points provides high reliability in a real-world environment.

2. Three plating types

3 Plating types are available to meet the customer's cost, performance requirements and applications. Under a normal environment with few mating/unmating requirements, tin plating can be used. Where there is a large number of mating/unmating requirements, then gold plating at 0.38 μm thickness should be used. If the environment is deleterious then gold plating at 0.76 μm thickness can be selected

3. Two types of contact pressure options

2 types of contact pressures are available depending on application: standard Contact pressure for withstanding a large number of mating/unmating requirements or other extreme environments, and high Contact pressure for vibration prone applications

4. High Current

Despite its small size, it conducts up to 15A (at a maximum temperature rise of 30°C). The latest developed copper alloy adds to the reliability of the 3-point contact structure

5. Audible Latching

When mating, a dear 'lock' sound and vibration will be felt by the assembler, that can prevent working 'blind' mis-mating (or halfmating) problems

6. Keying

The housing provides a keying (slit), hence mis-matings can be prevented by using the X and Y keys separately. At the same time, the keying plug can be used to create new key patterns.

D-3000 Series Performance and Specifications

Performance

Pitch	150mil (3.81mm)	200mil (5.08mm)
Item		
Rated Voltage	250V AC/DC	800V AC/DC (Pollution degree I)
Rated Current	1 pole:15A3 pole: 12A6 pole: 9.5A16 pole: 8A(AWG#16 for use as powersource)	
Contact resistance	10mΩ max	
Withstanding Voltage	1,500V AC(1 min)	2,200V AC(1 min)
Temperature	-55-+105°C	

Positions/Wire Size/Rated Current

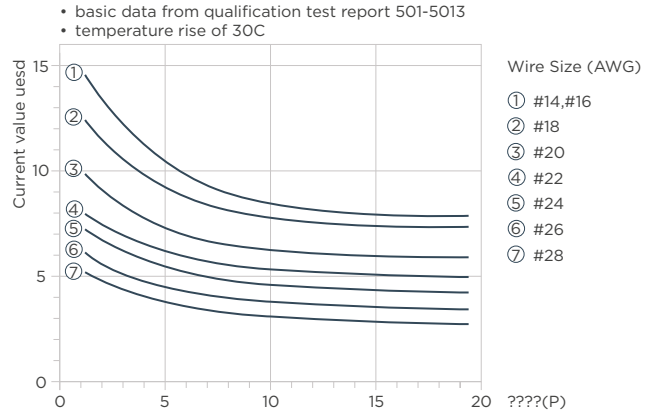

Performance & Specifications

Product Specifications	108-5349
Test Report	501-5013501-78668 FMLB
Applications Specifications	114-5148114-78030 FMLB
Pull tool product number(234168-1) manual	411-5726

Hand tool manual	
Tool product number	Instruction No.
91565-1 91559-1 91558-1 91560-1 91561-1	408-8547-1

Refer to instruction manuals for usage information.
An E-Catalogue is also available for download from the internet

Material and Plating

Category	Materials	Plating
Receptacle Contact Tab Contact	Copper alloys	Tin-plating or gold-plating over Nickel under-plated
Board Mount Header	Copper alloys	Tin-plating or gold-plating over Nickel under-plated
Housing	UL94V-0 thermoplastic PBT with glass fiber, PPS (SMT type), Black	

Safety Standards

The safety specifications listed below are approved on specific part numbers. Please contact our Technical Support Centre to check whether the part numbers you use are approved or not. Keep in mind that there are instances where values differ from those given by Tyco Electronics Specifications.

STD.	Series	D-3100 and D-3400 series (3.81mm pitch)			D-3200 and D-3500 series (5.08mm pitch)				
		Rated Voltage	Rated Current	Temperature Range	Rated Voltage	Rated Current	Temperature Range		
Product Specifications 108-5349		250V AC/DC	Above table	-55°C -+105°C	800V AC/DC(overvoltage type I, Pollution degree I)	Above table	-55°C -+105°C		
ULFile No.E28476 (Recognized Component)		Based on the requirements of Application	Based on the requirements of Application	—	Based on the requirements of Application	Based on the requirements of Application	—		
CSAReport No. LR7189		250V AC/DC	8A max	—	250V AC/DC	8A max	—		
TÜV License No. R9151488 (EN61984)IP protection level IP-00 Overvoltage type (II)		250V AC/DC	AWG	A	-55°C -+105°C	400V AC	AWG	A	-55°C -+105°C
	28		2	28			2		
	26		3	26			3		
	24		3	24			3		
	22		4	22			4		
	20		5	20			5		
	18		6	18			6		
	16	8	16	8					
	14	8	14	8					
Same as above Overvoltage type (III)		150V AC/DC	Same as above	Same as above	300V AC/DC	Same as above	Same as above		

D-3000 Series Configurations

All connector forms are provided, from the wire-to-wire panel type and free hanging type to the wire-to-board horizontal type and vertical type. Each position can carry a maximum current of up to 15A.

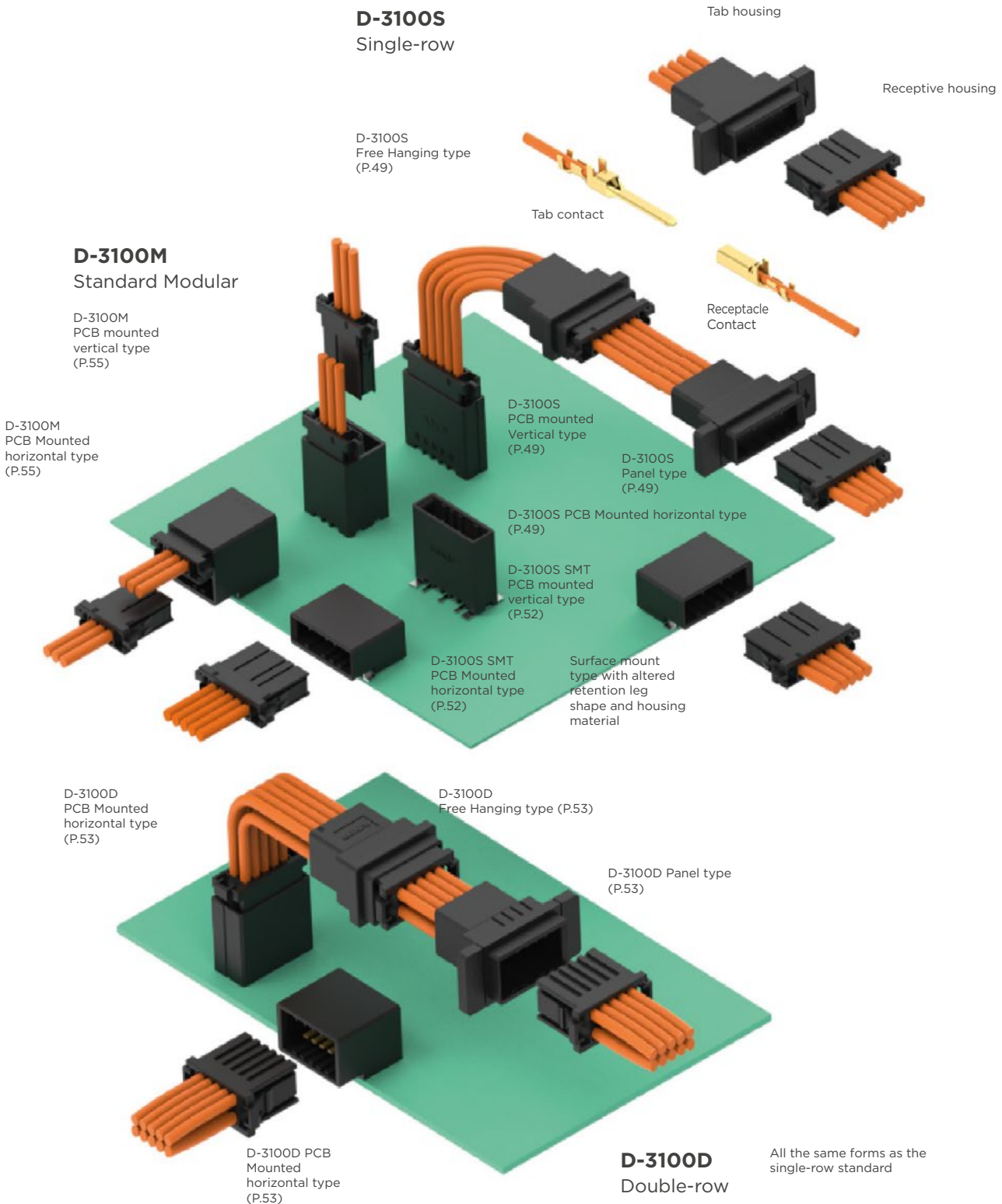

D-3000 Series Configurations

D-3200M
High Voltage
Modular
Suitable for high
voltage circuits

D-3200M
Suitable for use with
high voltage circuits
(P.59)

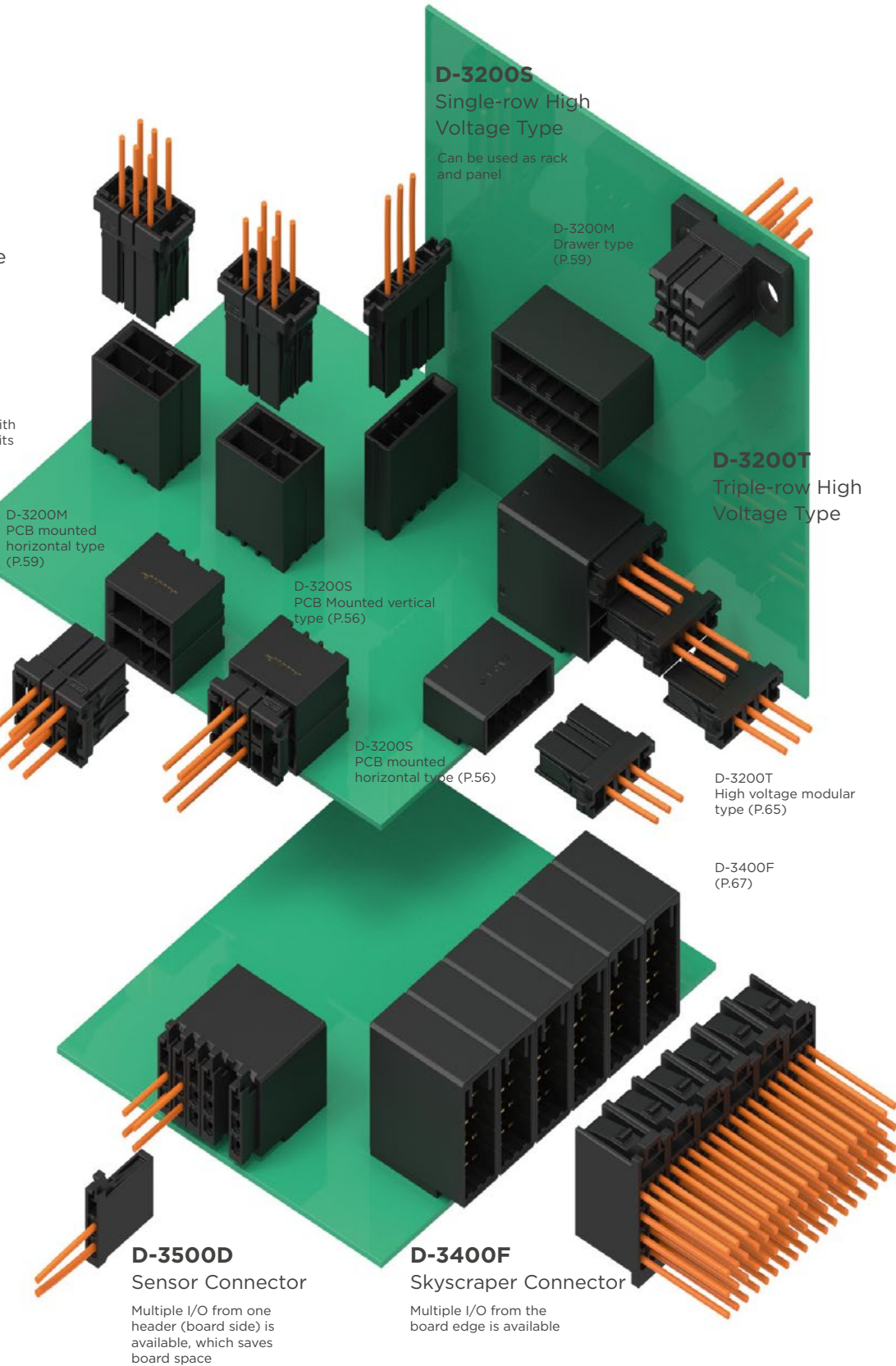

D-3000 Series Contact

Crimped type



Receptacle Contact
(used in receptacle housing)



Tab contact
(used in tab housing)

Wire Range		Outside Diameter of Insulation mm	Wire Range Mark	Contacts					Applicable tools	
AWG	mm ²			Receptacle Contact			Tab Contact		CCII Hand Tool PEW12 Hand Tool* (PEW12 dice only)	Mini Applicator
					Strip form	Loose Piece	Strip form	Loose Piece		
2826	0.08 0.12	0.8-1.2	S	Standard contact pressure(gold plating only)	175194-Δ 2298107-1**	175216-Δ 2311162-1**	175284-Δ	175287-Δ	91565-1	2836130-1
				High contact pressure	1-175194-Δ	1-175216-Δ				
24	0.20	1.0-1.4	M	Standard contact pressure(gold plating only)	175195-Δ 2298107-2**	175217-Δ 2311162-2** FMLB	175285-Δ	175288-Δ	91559-1	2151080-1
2220	0.30 0.50	1.7-2.6 (1.7-2.35)**		High contact pressure	1-175195-Δ	1-175217-Δ				
2018	0.50 0.85	1.8-2.8	L	Standard contact pressure(gold plating only)	175196-Δ 2298107-3**	175218-Δ 2311162-3**	175286-Δ	175289-Δ	91558-1	2151018-1
				High contact pressure	1-175196-Δ	1-175218-Δ				
16	1.25	2.2-2.8	2L	Standard contact pressure(gold plating only)	917484-Δ 2298107-4**	917511-Δ 2311162-4**	917485-Δ	917512-Δ	91560-1	2151119-1
				High contact pressure	1-917484-Δ	1-917511-Δ				
16	1.25	3.1-3.3	3L	Standard contact pressure(gold plating only)	353715-Δ 2298107-5**	353717-Δ 2311162-5**	353716-Δ	353718-Δ	91561-1	2151073-1
				High contact pressure	1-353715-Δ	1-353717-Δ				

Reference: Plating code
 – 2: 0.38 μm thickness gold plating
 – 3: 0.76 μm thickness gold plating
 – 5: Tin plating (only set to the high contact pressure type)
 – When placing your order, please check with sales for confirmed lead-times.
 – Please consult the sales department for micro-application tools

Strip Form contacts are used with Mini-applicators (bench machine) and Loose Piece contacts are with hand tools.
 * The outer diameter of the insulation is applicable to Loose Piece terminals.For strip form, see notes 114-5148
 ** Sequential (FMLB) female contacts. See 114-78030 in the operating manual.

The receptacle contact can be used in all receptacle housings, while the Tab housing can be used in all tabs housings
 Details of the applicable tool are available from P.120-124

NOTE: all products are RoHS compliant On selection.

D-3100S Single-row Standard – 3.81mm pin pitch

Type Chart

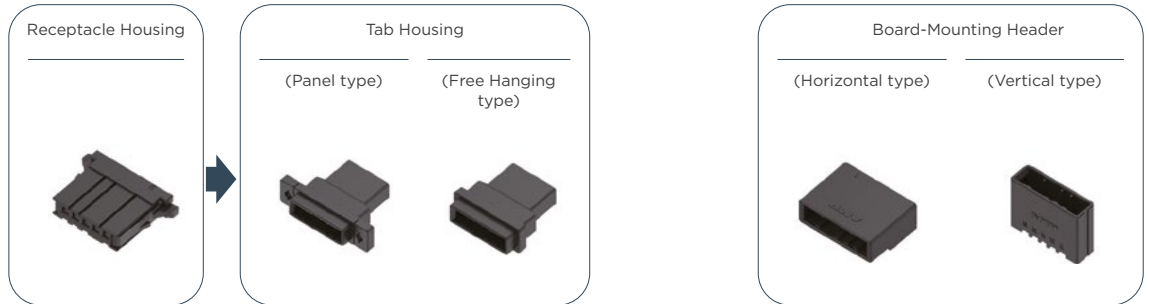

Pos	Color	Key	Receptacle housing	Tab housing			Plating	Board-Mounting Header	
				Panel type	Free Hanging type	L Bracket		Horizontal type	Vertical type
3	Black	X	1-178288-3	1-178802-3	1-177648-3	S	Gold	1-178293-2	1-178313-2
	Gold						1-178293-3	1-178313-3	
	Tin						1-178293-5	1-178313-5	
	Black	Y	2-178288-3	2-178802-3	2-177648-3	S	Gold	2-178293-2	2-178313-2
	Gold						2-178293-3	2-178313-3	
	Tin						2-178293-5	2-178313-5	
4	Black	X	1-178288-4	—	—	—	Gold	1-178294-2	1-178314-2
	Gold						1-178294-3	1-178314-3	
	Tin						1-178294-5	1-178314-5	
	Black	Y	2-178288-4	—	—	—	Gold	2-178294-2	2-178314-2
	Gold						2-178294-3	2-178314-3	
	Tin						—	2-178314-5	
5	Black	X	1-178288-5	1-178802-5	1-177648-5	L	Gold	1-178295-2	1-178315-2
	Gold						1-178295-3	1-178315-3	
	Tin						1-178295-5	1-178315-5	
6	Black	X	1-178288-6	—	—	—	Gold	1-178296-2	1-178316-2
	Gold						1-178296-3	1-178316-3	
	Tin						1-178296-5	1-178316-5	
	Black	Y	2-178288-6	—	—	—	Gold	2-178296-2	2-178316-2
	Gold						—	2-178316-3	
	Tin						—	2-178316-5	
8	Black	X	1-178288-7	1-178802-7	1-177648-7	L	Gold	1-178297-2	1-178317-2
	Gold						1-178297-3	1-178317-3	
	Tin						1-178297-5	1-178317-5	
10	Black	X	1-178288-8	1-178802-8	1-177648-8	L	Gold	1-178298-2	1-178318-2
	Gold						1-178298-3	1-178318-3	
	Tin						1-178298-5	1-178318-5	
	Gold						2-178298-3	2-178318-2	

Relative Product Information

Applicable contact...P.48
Performance & Specifications...P.45
Accessories...P.126

Mated Dimension

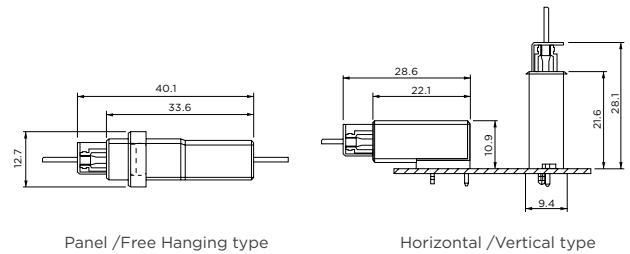

NOTE: All products are RoHS compliant On selection.

D-3100S Single-row Standard – 3.81mm pin pitch

External Dimensions

- Receptacle Housing

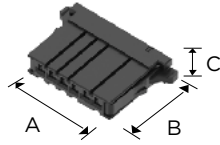

Pos	Key	Color	Part Number	Dimensions		
				A	B	C
3	X	Black	1-178288-3	26.8	22.8	7.2
	Y	Black	2-178288-3			
4	X	Black	1-178288-4	30.6		
	Y	Black	2-178288-4			
5	X	Black	1-178288-5	34.4		
6	X	Black	1-178288-6	38.2		
	Y	Black	2-178288-6			
8	X	Black	1-178288-7	45.8		
10	X	Black	1-178288-8	53.4		
	Y	Black	2-178288-8			

- Tab Housing

Panel type

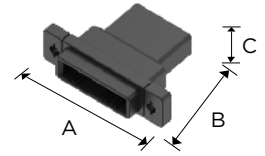

Pos	Key	Color	Part Number	Dimensions		
				A	B	C
3	X	Black	1-178802-3	40.0	33.6	12.7
	Y	Black	2-178802-3			
5	X	Black	1-178802-5	47.0		
8	X	Black	1-178802-7	59.0		
10	X	Black	1-178802-8	67.0		
	Y	Black	2-178802-8			

Free Hanging type

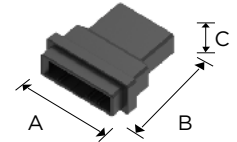

Pos	Key	Color	Part Number	Dimensions		
				A	B	C
3	X	Black	1-177648-3	25.6	33.6	12.7
	Y	Black	2-177648-3			
5	X	Black	1-177648-5	33.2		
8	X	Black	1-177648-7	44.6		
10	X	Black	1-177648-8	52.2		
	Y	Black	2-177648-8			

Applications

Example of elevator applications

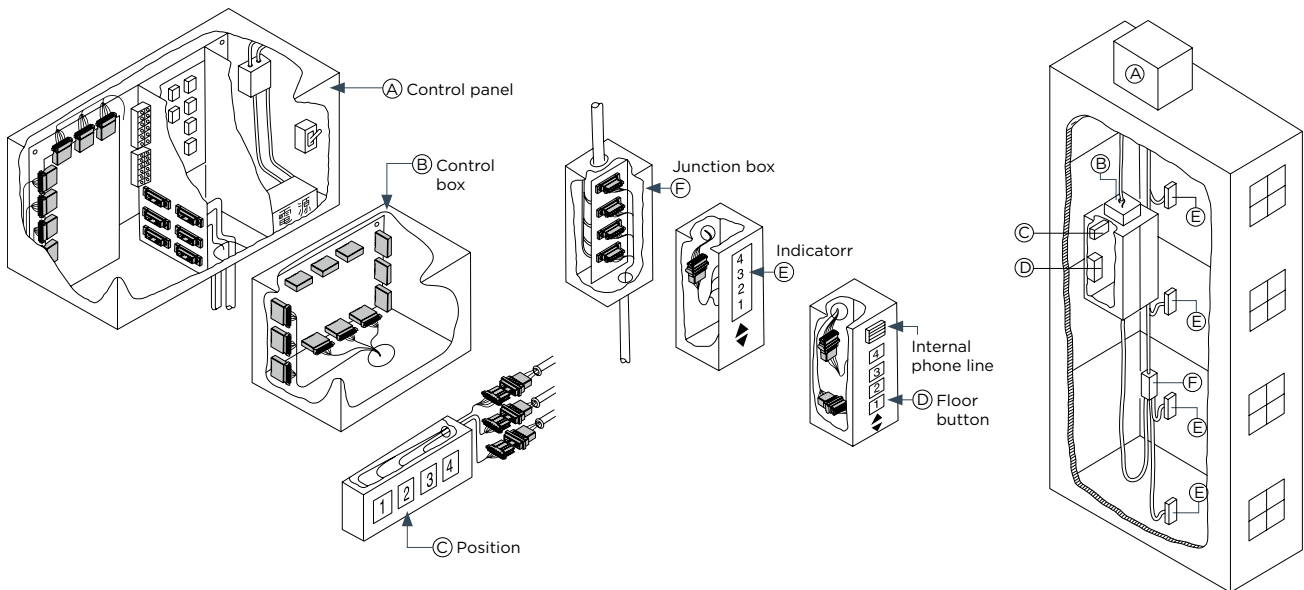

NOTE: All products are RoHS compliant On selection.

D-3100S Single-row Standard – 3.81mm pin pitch

Board-Mounting Header

Panel type

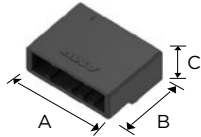

Pos	Key	Plating	Color	Part Number	Dimensions		
					A	B	C
3	X	Gold	Black	1-178293-2	21.6	22.1	10.9
		Gold	Black	1-178293-3			
		Tin	Black	1-178293-5			
	Y	Gold	Black	2-178293-2			
		Gold	Black	2-178293-3			
		Tin	Black	2-178293-5			
4	X	Gold	Black	1-178294-2	25.4	22.1	10.9
		Gold	Black	1-178294-3			
		Tin	Black	1-178294-5			
	Y	Gold	Black	2-178294-2			
Y	Gold	Black	2-178294-3				
5	X	Gold	Black	1-178295-2	29.2	22.1	10.9
		Gold	Black	1-178295-3			
		Tin	Black	1-178295-5			
6	X	Gold	Black	1-178296-2	33.1	22.1	10.9
		Gold	Black	1-178296-3			
		Tin	Black	1-178296-5			
	Y	Gold	Black	2-178296-2			
8	X	Gold	Black	1-178297-2	40.7	22.1	10.9
		Gold	Black	1-178297-3			
		Tin	Black	1-178297-5			
10	X	Gold	Black	1-178298-2	48.3	22.1	10.9
		Gold	Black	1-178298-3			
		Tin	Black	1-178298-5			
	Y	Gold	Black	2-178298-3			

Board-Mounting Header

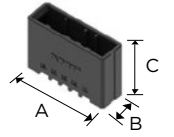

Pos	Key	Plating	Color	Part Number	Dimensions		
					A	B	C
3	X	Gold	Black	1-178313-2	21.6	9.4	21.6
		Gold	Black	1-178313-3			
		Tin	Black	1-178313-5			
	Y	Gold	Black	2-178313-2			
		Gold	Black	2-178313-3			
		Tin	Black	2-178313-5			
4	X	Gold	Black	1-178314-2	25.4	9.4	21.6
		Gold	Black	1-178314-3			
		Tin	Black	1-178314-5			
	Y	Gold	Black	2-178314-2			
Y	Gold	Black	2-178314-3				
5	X	Gold	Black	1-178315-2	29.2	9.4	21.6
		Gold	Black	1-178315-3			
		Tin	Black	1-178315-5			
6	X	Gold	Black	1-178316-2	33.1	9.4	21.6
		Gold	Black	1-178316-3			
		Tin	Black	1-178316-5			
	Y	Gold	Black	2-178316-2			
Y	Gold	Black	2-178316-3				
Y	Tin	Black	2-178316-5				
8	X	Gold	Black	1-178317-2	40.7	9.4	21.6
		Gold	Black	1-178317-3			
		Tin	Black	1-178317-5			
10	X	Gold	Black	1-178318-2	48.3	9.4	21.6
		Gold	Black	1-178318-3			
		Tin	Black	1-178318-5			
	Y	Gold	Black	2-178318-2			

NOTE: All products are RoHS compliant On selection.

D-3100S Single-row SMT Types – 3.81mm pin pitch

Type Chart

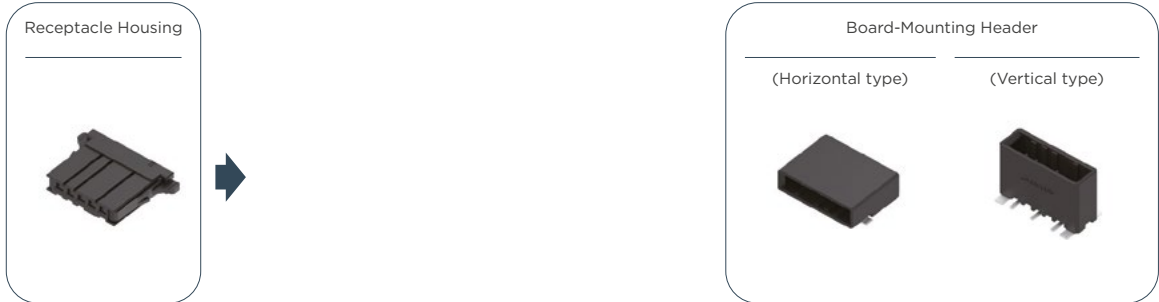

Pos	Color	Key	Receptacle housing	Tab housing		Plating	Board-Mounting Header	
				Panel type	Free Hanging type		Horizontal type	Vertical type
5	Black	X	1-178288-5	—	—	Gold	1-177662-2	1-177665-2
8	Black		1-178288-7	—	—	Gold	1-179188-2	—
	Black	—	—	—	Gold	1-179188-3		

Mated Dimension

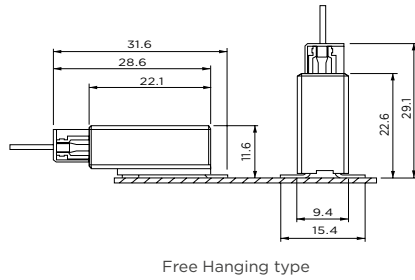

External Dimensions

- Receptacle Housing

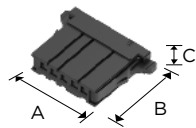

Pos	Key	Color	Part Number	Dimensions		
				A	B	C
5	X	Black	1-178288-5	34.4	22.8	7.2
8			1-178288-7	45.8		

- Board-Mounting Header

Horizontal type

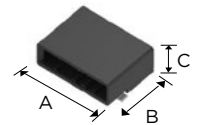

Pos	Key	Plating	Color	Part Number	Dimensions		
					A	B	C
5	X	Gold	Black	1-177662-2	29.2	22.1	11.6
8	X	Gold	Black	1-179188-2	40.7		
		Gold	Black	1-179188-3			

Vertical type

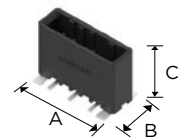

Pos	Key	Plating	Color	Part Number	Dimensions		
					A	B	C
5	X	Gold	Black	1-177665-2	29.2	9.4	22.6

NOTE: All products are RoHS compliant On selection.

D-3100D Double-row Standard Type – 3.81mm pin pitch

Type Chart

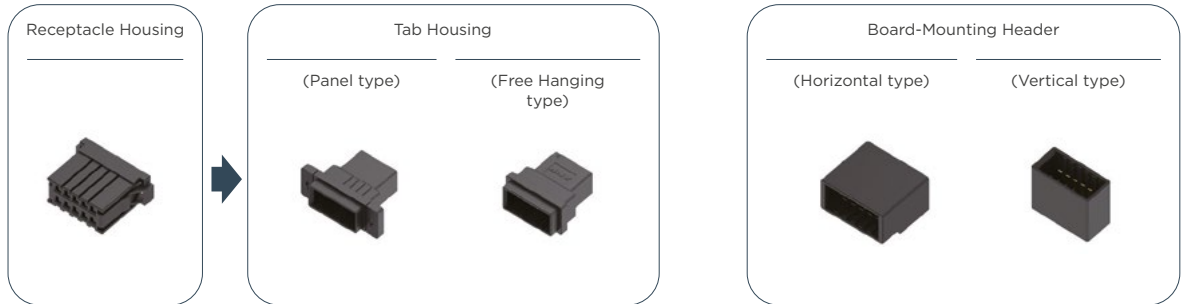

Pos	Color	Key	Receptacle housing	Tab housing			Plating	Board-Mounting Header	
				Panel type	Free Hanging type	L Bracket		Horizontal type	Vertical type
6	Black	X	178289-3	178803-3	178964-3	S	Gold	178303-2	178323-2
	Black	X				S		178303-3	178323-3
	Black	X				S	178303-5	178323-5	
8	Black	X	178289-4	—	178964-4	S	Gold	1717412-2	1903601-2
	Black	X				S		1717412-3	—
	Black	X				S	Tin	—	1903601-5
10	Black	X	178289-5	178803-5	178964-5	L	Gold	178305-2	178325-2
	Black	X				L		178305-3	178325-3
	Black	X				L	Tin	178305-5	178325-5
12	Black	X	178289-6	178803-6	178964-6	L	Gold	178306-2	178326-2
	Black	X				L		178306-3	178326-3
	Black	X				L	Tin	178306-5	178326-5
16	Black	X	178289-7	178803-7	178964-7	L	Gold	178307-2	178327-2
	Black	X				L		178307-3	178327-3
	Black	X				L	Tin	178307-5	178327-5
20	Black	X	178289-8	178803-8	178964-8	L	Gold	178308-2	178328-2
	Black	X				L		178308-3	178328-3
	Black	X				L	Tin	178308-5	178328-5

Relative Product Information

Applicable contact...P.48
Performance & Specifications...P.45
Accessories...P.126

Board-Mounting Header

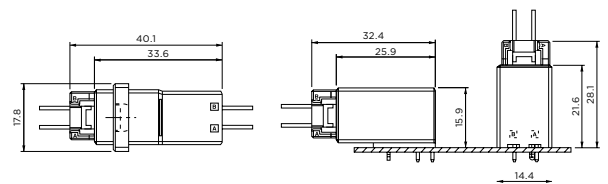

Panel /Free Hanging type

Horizontal /Vertical type

Applications

Example of Programmable Controller Application

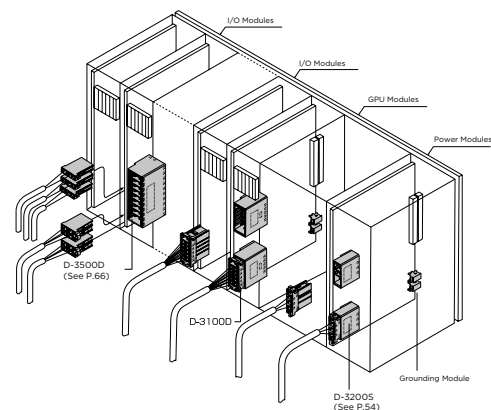

NOTE: All products are RoHS compliant On selection.

D-3100D Double-row Standard Type – 3.81mm pin pitch

External Dimensions

- Receptacle Housing

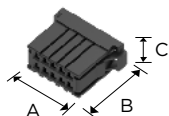

Pos	Key	Color	Part Number	Dimensions		
				A	B	C
6	X	Black	178289-3	24.4	22.8	12.5
8	X	Black	178289-4	28.2		
10	X	Black	178289-5	32.0		
12	X	Black	178289-6	35.8		
16	X	Black	178289-7	42.7		
20	X	Black	178289-8	51.0		

Tab Housing

Panel type

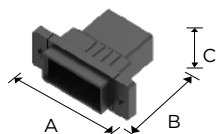

Pos	Key	Color	Part Number	Dimensions		
				A	B	C
6	X	Black	178803-3	40.0	33.6	17.8
10	X	Black	178803-5	47.0		
12	X	Black	178803-6	51.0		
16	X	Black	178803-7	59.0		
20	X	Black	178803-8	67.0		

Free Hanging type

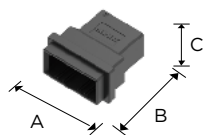

Pos	Key	Color	Part Number	Dimensions		
				A	B	C
6	X	Black	178964-3	25.6	33.6	17.8
8	X	Black	178964-4	29.4		
10	X	Black	178964-5	33.2		
12	X	Black	178964-6	37.0		
16	X	Black	178964-7	44.6		
20	X	Black	178964-8	52.2		

Board-Mounting Header

Horizontal type

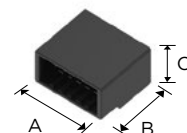

Pos	Key	Plating	Color	Part Number	Dimensions		
					A	B	C
6	X	Gold	Black	178303-2	21.6	25.9	15.9
	X		Black	178303-3			
	X	Tin	Black	178303-5			
8	X	Gold	Black	1717412-2	25.4		
	X		Black	1717412-3			
10	X	Gold	Black	178305-2	29.2		
	X		Black	178305-3			
	X	Tin	Black	178305-5			
12	X	Gold	Black	178306-2	33.1		
	X		Black	178306-3			
	X	Tin	Black	178306-5			
16	X	Gold	Black	178307-2	40.7		
	X		Black	178307-3			
	X	Tin	Black	178307-5			
20	X	Gold	Black	178308-2	48.3		
	X		Black	178308-3			
	X	Tin	Black	178308-5			

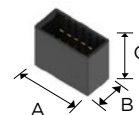

Pos	Key	Plating	Color	Part Number	Dimensions		
					A	B	C
6	X	Gold	Black	178323-2	21.6	14.4	21.6
	X		Black	178323-3			
	X	Tin	Black	178323-5			
8	X	Gold	Black	1903601-2	25.4		
	X	Tin	Black	1903601-5			
10	X	Gold	Black	178325-2	29.2		
	X		Black	178325-3			
	X	Tin	Black	178325-5			
12	X	Gold	Black	178326-2	33.1		
	X		Black	178326-3			
	X	Tin	Black	178326-5			
16	X	Gold	Black	178327-2	40.7		
	X		Black	178327-3			
	X	Tin	Black	178327-5			
20	X	Gold	Black	178328-2	48.3		
	X		Black	178328-3			
	X	Tin	Black	178328-5			

NOTE: All products are RoHS compliant On selection.

D-3100M Double-row Standard Modular Type – 3.81mm pin pitch

Type Chart

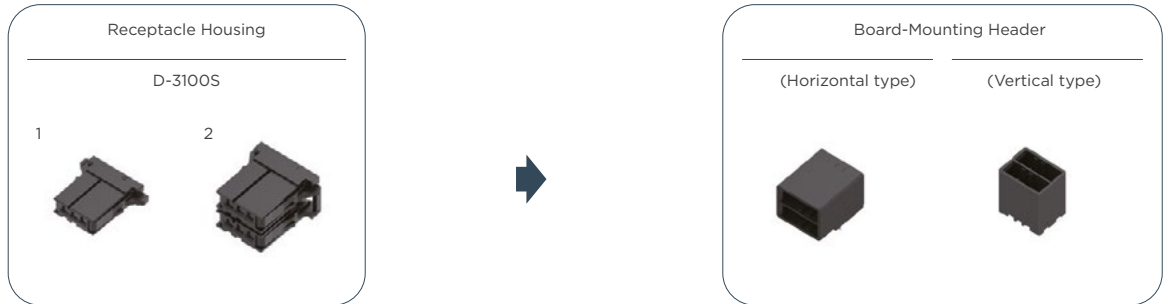

Pos	Color	Key	Receptacle housing		Tab housing		Plating	Board-Mounting Header	
			1 row 3 pos.	2 row 6 pos.	Panel type	Free Hanging type		Horizontal type	Vertical type
6	Black	XX	1-178288-3 (2)	1-178127-6 (1)	-	-	Gold	1-178137-2	1-178141-2
	Black						Gold	1-178137-3	1-178141-3
	Black						Tin	1-178137-5	1-178141-5
	Black	YY	2-178288-3 (2)	2-178127-6 (1)			Gold	2-178137-2	-
	Black						Tin	2-178137-5	-
	Black						Gold	3-178137-2	3-178141-2
Black	XY	1-178288-3 (1)2-178288-3 (1)	3-178127-6 (1)	Gold	3-178137-3	3-178141-3			
Black				Gold	3-178137-3	3-178141-3			
Black				Tin	3-178137-5	3-178141-5			

Relative Product Information

Applicable contact...P.48
Performance & Specifications ...P.45

Mated Dimension

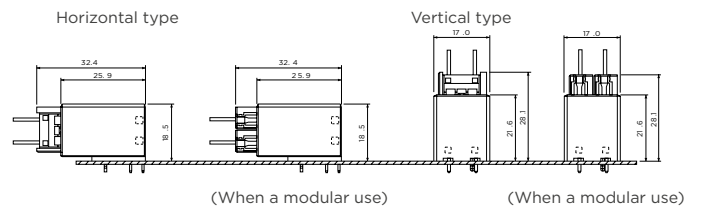

External Dimensions

- Receptacle Housing

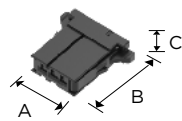

Pos	Key	Color	Part Number	Dimensions		
				A	B	C
3	X	Black	1-178288-3	26.8	22.8	7.2
	Y		2-178288-3			

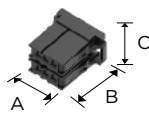

Pos	Key	Color	Part Number	Dimensions		
				A	B	C
6	XX	Black	1-178127-6	24.8	22.8	14.8
	YY	Black	2-178127-6			
	XY	Black	3-178127-6			

- Board-Mounting Header

Horizontal type

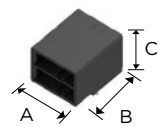

Pos	Key	Plating	Color	Part Number	Dimensions		
					A	B	C
6	XX	Gold	Black	1-178137-2	21.6	25.9	18.5
		Black	1-178137-3				
		Tin	Black	1-178137-5			
	YY	Gold	Black	2-178137-2			
		Black	2-178137-5				
		Tin	Black	2-178137-5			
XY	Gold	Black	3-178137-2				
	Black	3-178137-3					
	Tin	Black	3-178137-5				

Vertical type

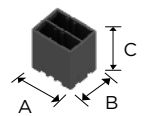

Pos	Key	Plating	Color	Part Number	Dimensions		
					A	B	C
6	XX	Gold	Black	1-178141-2	21.6	17.0	21.6
		Black	1-178141-3				
		Tin	Black	1-178141-5			
	XY	Gold	Black	3-178141-2			
		Black	3-178141-3				
		Tin	Black	3-178141-5			

NOTE: All products are RoHS compliant On selection.

D-3200S Single-row High Voltage Type – 5.08mm pin pitch

Type Chart



Pos	Color	Key	Receptacle housing	Tab housing			Plating	Board-Mounting Header	
				Panel type	Free Hanging type	L Bracket		Horizontal type	Vertical type
2	Black	X	1-178128-2	1-179553-2	1-179552-2	S	Gold	1-179276-2	1-917337-2
	Black						Gold	1-179276-3	1-917337-3
	Black						Tin	1-179276-5	1-917337-5
	Black	Y	2-178128-2	2-179553-2	2-179552-2		Gold	2-179276-2	2-917337-2
	Black						Gold	2-179276-3	2-917337-3
	Black						Tin	—	2-917337-5
3	Black	X	1-178128-3	1-179553-3	1-179552-3	Gold	1-178138-2	1-178136-2	
	Black					Gold	1-178138-3	1-178136-3	
	Black					Tin	1-178138-5	1-178136-5	
	Black	Y	2-178128-3	2-179553-3	2-179552-3	Gold	2-178138-2	2-178136-2	
	Black					Gold	2-178138-3	2-178136-3	
	Black					Tin	2-178138-5	2-178136-5	
Black	Z	3-178128-3	—	—	—	Tin	—	3-178136-5	
4	Black	X	1-178128-4	1-179553-4	1-179552-4	S	Gold	1-179277-2	1-917338-2
	Black						Gold	1-179277-3	1-917338-3
	Black						Tin	1-179277-5	1-917338-5
	Black	Y	2-178128-4	2-179553-4	2-179552-4		Gold	2-179277-2	2-917338-2
	Black						Gold	2-179277-3	2-917338-3
	Black						Tin	2-179277-5	2-917338-5
5	Black	X	1-178128-5	—	—	Gold	1-316130-2	1-316132-2	
	Black					Gold	1-316130-3	1-316132-3	
	Black					Tin	1-316130-5	1-316132-5	
	Black	Y	2-178128-5			Gold	2-316130-2	2-316132-2	
	Black					Gold	2-316130-3	2-316132-3	
	Black					Gold	2-316130-5	2-316132-5	
6	Black	X	1-178128-6	—	—	Gold	1-316131-2	1-316133-2	
	Black					Gold	1-316131-3	1-316133-3	
	Black					Tin	1-316131-5	1-316133-5	
	Black	Y	2-178128-6			Gold	2-316131-2	2-316133-2	
	Black					Gold	—	2-316133-3	
	Black					Tin	2-316131-5	—	

Relative Product Information

Applicable contact...P.48

Performance & Specifications ...P.45

Accessories ...P.126

NOTE: All products are RoHS compliant On selection.

D-3200S Single-row High Voltage Type - 5.08mm pin pitch

Mated Dimension

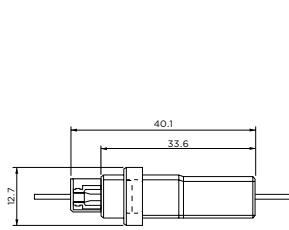

Panel /Free Hanging type

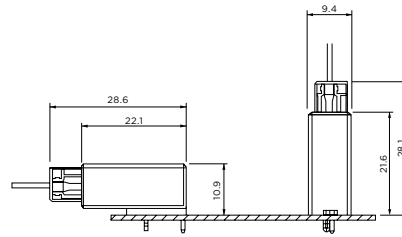

Horizontal /Vertical type

External Dimensions

- Receptacle Housing

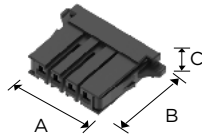

Pos	Key	Color	Part Number	Dimensions		
				A	B	C
2	X	Black	1-178128-2	24.6	22.8	7.2
	Y	Black	2-178128-2			
3	X	Black	1-178128-3	29.7		
	Y	Black	2-178128-3			
	Z	Black	3-178128-3			
4	X	Black	1-178128-4	34.8		
	Y	Black	2-178128-4			
5	X	Black	1-178128-5	39.9		
	Y	Black	2-178128-5			
6	X	Black	1-178128-6	45.0		
	Y	Black	2-178128-6			

- Tab Housing

Panel type

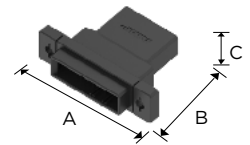

Pos	Key	Color	Part Number	Dimensions		
				A	B	C
2	X	Black	1-179553-2	36.8	33.6	12.7
	Y	Black	2-179553-2			
3	X	Black	1-179553-3	41.9		
	Y	Black	2-179553-3			
4	X	Black	1-179553-4	47.0		
	Y	Black	2-179553-4			

Free Hanging type

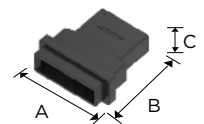

Pos	Key	Color	Part Number	Dimensions		
				A	B	C
2	X	Black	1-179552-2	23.0	33.6	12.7
	Y	Black	2-179552-2			
3	X	Black	1-179552-3	28.1		
	Y	Black	2-179552-3			
4	X	Black	*1-179552-4	33.2		
	Y	Black	*2-179552-4			

*DIN rail attachment is available. P/N : 2822900-1
Applicable P/N : Δ-179552-4

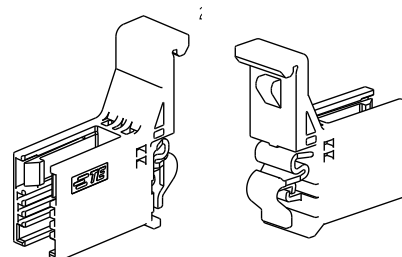

NOTE: All products are RoHS compliant On selection.

D-3200S Single-row Standard – 5.08mm pin pitch

- Board-Mounting Header

Horizontal type

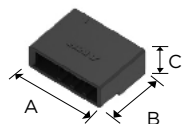

Pos	Key	Plating	Color	Part Number	Dimensions		
					A	B	C
2	X	Gold	Black	1-179276-2	19.1	22.1	10.9
			Black	1-179276-3			
	Tin	1-179276-5					
	Y	Gold	Black	2-179276-2			
Black			2-179276-3				
3	X	Gold	Black	1-178138-2	24.2	22.1	10.9
			Black	1-178138-3			
	Tin	1-178138-5					
	Y	Gold	Black	2-178138-2			
Black			2-178138-3				
4	X	Gold	Black	1-179277-2	29.2	22.1	10.9
			Black	1-179277-3			
	Tin	1-179277-5					
	Y	Gold	Black	2-179277-2			
Black			2-179277-3				
5	X	Gold	Black	1-316130-2	34.3	22.1	10.9
			Black	1-316130-3			
	Tin	1-316130-5					
	Y	Gold	Black	2-316130-2			
Black			2-316130-3				
6	X	Gold	Black	1-316131-2	39.4	22.1	10.9
			Black	1-316131-3			
	Tin	1-316131-5					
	Y	Gold	Black	2-316131-2			
Black			2-316131-3				

- Board-Mounting Header

Vertical type

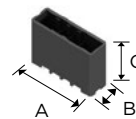

Pos	Key	Plating	Color	Part Number	Dimensions		
					A	B	C
2	X	Gold	Black	1-917337-2	19.1	9.4	21.6
			Black	1-917337-3			
	Tin	1-917337-5					
	Y	Gold	Black	2-917337-2			
Black			2-917337-3				
3	X	Gold	Black	1-178136-2	24.2	9.4	21.6
			Black	1-178136-3			
	Tin	1-178136-5					
	Y	Gold	Black	2-178136-2			
Black			2-178136-3				
4	X	Gold	Black	1-178136-2	29.2	9.4	21.6
			Black	1-178136-3			
	Tin	1-178136-5					
	Y	Gold	Black	2-178136-2			
Black			2-178136-3				
5	X	Gold	Black	1-917338-2	34.3	9.4	21.6
			Black	1-917338-3			
	Tin	1-917338-5					
	Y	Gold	Black	2-917338-2			
Black			2-917338-3				
6	X	Gold	Black	1-316132-2	39.4	9.4	21.6
			Black	1-316132-3			
	Tin	1-316132-5					
	Y	Gold	Black	2-316132-2			
Black			2-316132-3				

NOTE: All products are RoHS compliant On selection.

D-3200M Double-row High Voltage Types – 5.08mm pin pitch

Type Chart

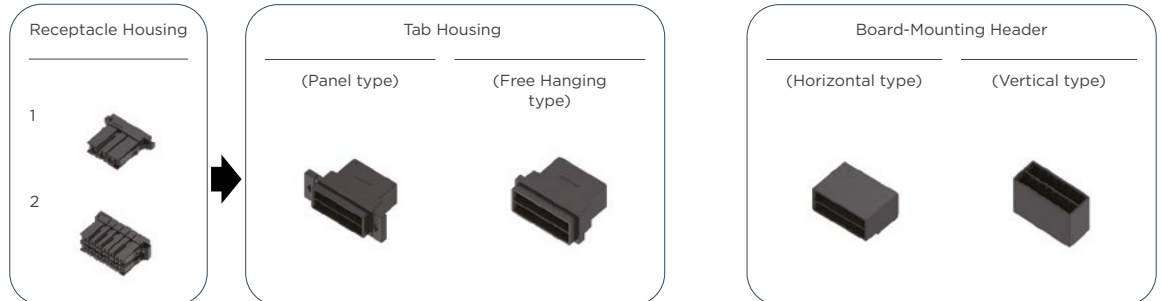

Pos	Color	Key	Receptacle housing (2)	Tab housing			Plating	Board-Mounting Header	
				Panel type	Free Hanging type	L Bracket		Horizontal type	Vertical type
6	–	XX	1-178129-6	1-179555-3	1-179554-3	S	Gold	1-178139-2	1-178140-2
	–					S	Gold	1-178139-3	1-178140-3
	–					S	Tin	1-178139-5	1-178140-5
	–	YY	2-178129-6	2-179555-3	2-179554-3	S	Gold	2-178139-2	2-178140-2
	–					S	Gold	2-178139-3	2-178140-3
	–					S	Tin	2-178139-5	2-178140-5
	–	XY	3-178129-6	3-179555-3	3-179554-3	S	Gold	3-178139-2	3-178140-2
	–					S	Gold	3-178139-3	3-178140-3
	–					S	Tin	3-178139-5	3-178140-5
	–	YX	*(1)	–	–	–	Gold	4-178139-2	–
–	ZX	*(1)	–	–	–	Tin	6-178139-5	–	
10	–	XX	1-917659-5	–	–	–	Gold	1-316080-2	1-917657-2
	–			–	–	–	Gold	1-316080-3	1-917657-3
	–			–	–	–	Tin	1-316080-5	1-917657-5
	–	YY	2-917659-5	–	–	–	Gold	2-316080-2	2-917657-2
	–			–	–	–	Gold	2-316080-3	2-917657-3
	–			–	–	–	Tin	2-316080-5	2-917657-5
	–	XY	3-917659-5	–	–	–	Gold	3-316080-2	3-917657-2
	–			–	–	–	Gold	3-316080-3	3-917657-3
	–			–	–	–	Tin	3-316080-5	3-917657-5
	12	–	XX	1-917659-6	1-179555-6	1-179554-6	L	Gold	1-316081-2
–		L					Gold	1-316081-3	1-917658-3
–		L					Tin	1-316081-5	1-917658-5
–		YY	2-917659-6	2-179555-6	–	L	Gold	2-316081-2	2-917658-2
–						L	Gold	2-316081-3	2-917658-3
–						L	Tin	–	–
–		XY	3-917659-6	3-179555-6	3-179554-6	L	Gold	3-316081-2	3-917658-2
–						L	Gold	3-316081-3	3-917658-3
–	L					Tin	–	–	
20	–	XX	1-917659-8	1-179555-8	–	–	–	–	

Relative Product Information

Applicable contact...P.48

Performance & Specifications ...P.45

Accessories ...P.126

For(1)D-3200S Receptacle housing, please see P.56
PN 1-178128-3 and 3-178128-3 are used.

NOTE: All products are RoHS compliant On selection.

D-3200M Double-row High-voltage Modular Types - 5.08mm pin pitch

Mated Dimension

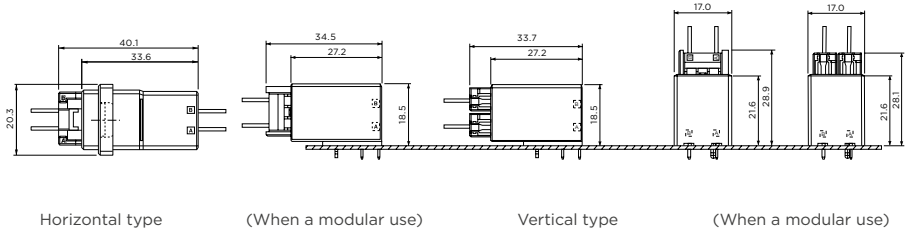

External Dimensions

- Receptacle Housing

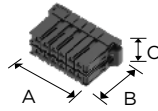

Pos	Key	Color	Part Number	Dimensions		
				A	B	C
6	XX	Black	1-178129-6	27.3	22.8	14.8
	YY	Black	2-178129-6			
	XY	Black	3-178129-6			
10	XX	Black	1-917659-5	37.5		
	YY	Black	2-917659-5			
	XY	Black	3-917659-5			
12	XX	Black	1-917659-6	42.5		
	YY	Black	2-917659-6			
	XY	Black	3-917659-6			
20	XX	Black	1-917659-8	62.9		

- Tab Housing

Panel type

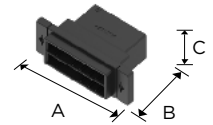

Pos	Key	Color	Part Number	Dimensions		
				A	B	C
6	XX	Black	1-179555-3	41.9	33.6	20.3
	YY	Black	2-179555-3			
	XY	Black	3-179555-3			
12	XX	Black	1-179555-6	57.9		
	YY	Black	2-179555-6			
	XY	Black	3-179555-6			
20	XX	Black	1-179555-8	78.2		

Free Hanging type

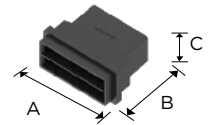

Pos	Key	Color	Part Number	Dimensions		
				A	B	C
6	XX	Black	1-179554-3	28.1	33.6	20.3
	YY	Black	2-179554-3			
	XY	Black	3-179554-3			
12	XX	Black	1-179554-6	43.4		
	XY	Black	3-179554-6			

NOTE: All products are RoHS compliant On selection.

D-3200M Double-row High-voltage Modular Types – 5.08mm pin pitch

Board-Mounting Header

Horizontal type

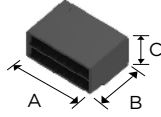

Pos	Key	Plating	Color	Part Number	Dimensions						
					A	B	C				
6	XX	Gold	Black	1-178139-2	24.2	27.2	18.5				
		Gold	Black	1-178139-3							
		Tin	Black	1-178139-5							
	YY	Gold	Black	2-178139-2							
		Gold	Black	2-178139-3							
		Tin	Black	2-178139-5							
	XY	Gold	Black	3-178139-2							
		Gold	Black	3-178139-3							
		Tin	Black	3-178139-5							
	YX	Gold	Black	4-178139-2							
		ZX	Tin	Black				6-178139-5			
	10	XX	Gold	Black				1-316080-2	34.3	27.2	18.5
Gold			Black	1-316080-3							
Tin			Black	1-316080-5							
YY		Gold	Black	2-316080-2							
		Gold	Black	2-316080-3							
		Tin	Black	2-316080-5							
XY		Gold	Black	3-316080-2							
		Gold	Black	3-316080-3							
		Tin	Black	3-316080-5							
12		XX	Gold	Black	1-316081-2	39.4	27.2	18.5			
			Gold	Black	1-316081-3						
			Tin	Black	1-316081-5						
	YY	Gold	Black	2-316081-2							
		Gold	Black	2-316081-3							
		Tin	Black	—							
	XY	Gold	Black	3-316081-2							
		Gold	Black	3-316081-3							
		Gold	Black	3-316081-3							

Board-Mounting Header

Vertical type

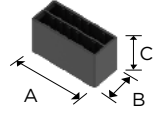

Pos	Key	Plating	Color	Part Number	Dimensions						
					A	B	C				
6	XX	Gold	Black	1-178140-2	24.2	27.2	18.5				
		Gold	Black	1-178140-3							
		Tin	Black	1-178140-5							
	YY	Gold	Black	2-178140-2							
		Gold	Black	2-178140-3							
		Tin	Black	2-178140-5							
	XY	Gold	Black	3-178140-2							
		Gold	Black	3-178140-3							
		Tin	Black	3-178140-5							
	10	XX	Gold	Black				1-917657-2	34.3	17.0	21.6
			Gold	Black				1-917657-3			
			Tin	Black				1-917657-5			
YY		Gold	Black	2-917657-2							
		Gold	Black	2-917657-3							
		Tin	Black	2-917657-5							
XY		Gold	Black	3-917657-2							
		Gold	Black	3-917657-3							
		Tin	Black	3-917657-5							
12		XX	Gold	Black	1-917658-2	39.4	27.2	18.5			
			Gold	Black	1-917658-3						
			Tin	Black	1-917658-5						
	YY	Gold	Black	2-917658-2							
		Gold	Black	2-917658-3							
		Tin	Black	—							
	XY	Gold	Black	3-917658-2							
		Gold	Black	3-917658-3							
		Tin	Black	—							

NOTE: All products are RoHS compliant On selection.

D-3200M Double-row High-voltage Modular Types - 5.08mm pin pitch

Type Chart

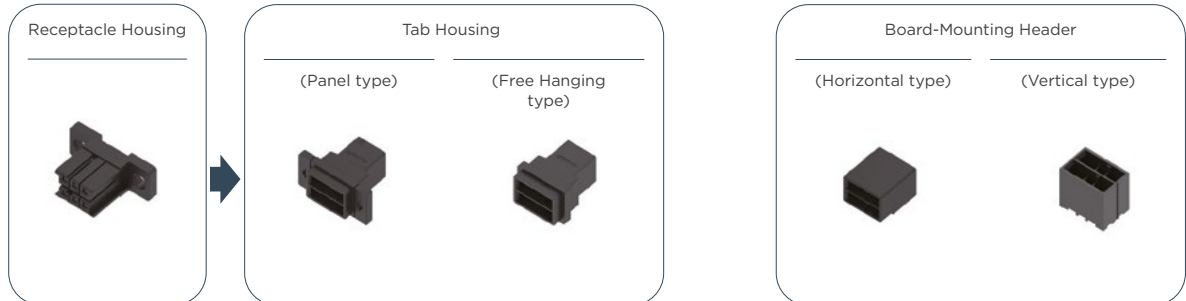

Pos	Color	Key	Receptacle housing	Tab housing		Plating	Board-Mounting Header	
				Panel type	Free Hanging type		Horizontal type	Vertical type
6	Black	XX	1-917266-3	1-179555-3	1-179554-3	Gold	1-178139-2	1-178140-2
						Gold	1-178139-3	1-178140-3
						Tin	1-178139-5	1-178140-5

Relative Product Information

Applicable contact...P.48

Performance & Specifications ...P.45

Accessories ...P.126

Applications

Example of Compact Disk Device Application

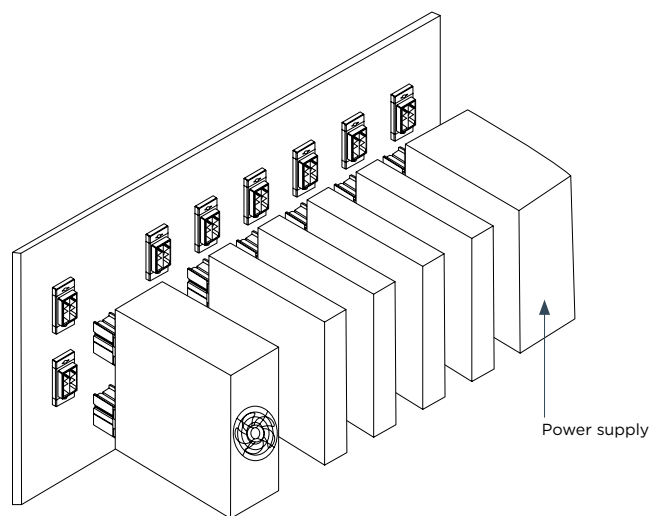

NOTE: All products are RoHS compliant On selection.

D-3200M Double-row High voltage Drawer Types - 5.08mm pin pitch

Mated Dimension

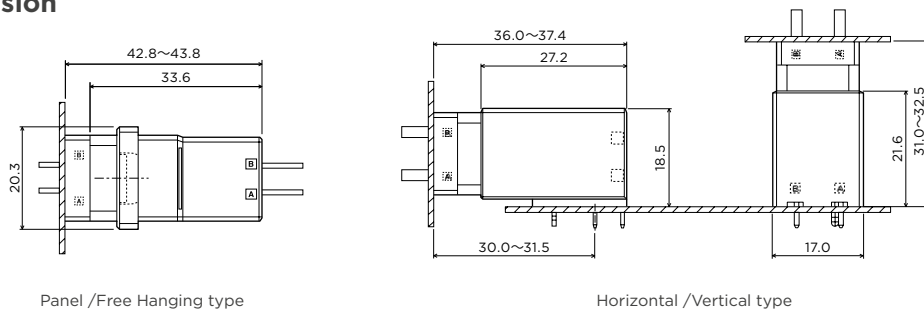

External Dimensions

- Receptacle Housing (Drawer type)

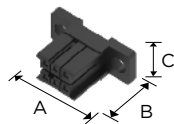

Pos	Key	Color	Part Number	Dimensions		
				A	B	C
6	XX	Black	1-917266-3	40.0	25.7	15.4

- Tab Housing

Panel type

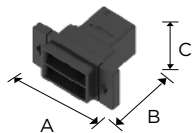

Pos	Key	Color	Part Number	Dimensions		
				A	cB	C
6	XX	Black	1-179555-3	41.9	33.6	20.3

Free Hanging type

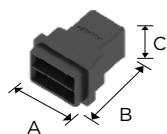

Pos	Key	Color	Part Number	Dimensions		
				A	B	C
6	XX	Black	1-179554-3	28.1	33.6	20.3

- Board-Mounting Header

Horizontal type

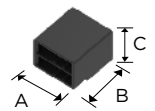

Pos	Key	Plating	Color	Part Number	Dimensions		
					A	B	C
6	XX	Gold	Black	1-178139-2	24.2	27.2	18.5
			Black	1-178139-3			
		Tin	Black	1-178139-5			

Vertical type

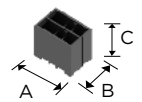

Pos	Key	Plating	Color	Part Number	Dimensions		
					A	B	C
6	XX	Gold	Black	1-178140-2	24.2	17.0	21.6
			Black	1-178140-3			
		Tin	Black	1-178140-5			

NOTE: All products are RoHS compliant On selection.

D-3200 FMLB (Sequential Type) – 5.08mm pin pitch

Type Chart



Pos	Key	Color	Receptacle housing	Tab housing		Plating	Board-Mounting Header				
				Panel type	Free Hanging type		Horizontal type	Vertical type			
4	RR	Black	1-2303376-1		-	Gold	1-2299004-1				
	SS	Black	2-2303376-1			Gold	2-2299004-1				
12	RR	Black	1-2303378-1						Gold	1-2299005-1	
	SS	Black	2-2303378-1						Gold	2-2299005-1	
	RS	Black	3-2303378-1						Gold	3-2299005-1	
									Gold	3-2299005-1	

Mated Dimension

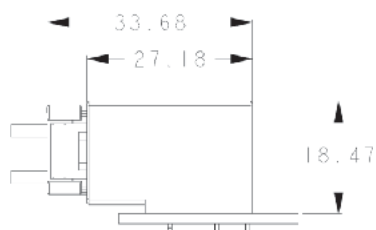

External Dimensions

- Receptacle Housing

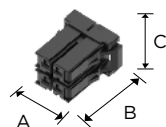

Pos	Key	Color	Part Number	Dimensions		
				A	B	C
4	RR	Black	1-2291727-1	14.2	22.8	14.8
	SS	Black	2-2291727-1			
12	RR	Black	1-2291728-1	34.5		
	SS	Black	2-2291728-1			

Relative Product Information

Applicable contact...P.48
Performance & Specifications ...P.45
Accessories ...P.126

NOTE: All products are RoHS compliant On selection.

- Board-Mounting Header

Horizontal type

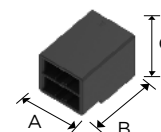

Pos	Key	Plating	Color	Part Number	Dimensions		
					A	B	C
4	RR	-	Black	1-2299004-1	14.2	22.8	14.8
	SS		Black	2-2299004-1			
12	RR	-	Black	1-2299005-1	34.5		
	SS		Black	2-2299005-1			
	RS		Black	3-2299005-1			

Strain relief (optional)

Pos	Key	Color	Part Number
4	RR	Black	1-2303376-1
	SS	Black	2-2303376-1
12	RR	Black	1-2303378-1
	SS	Black	2-2303378-1
	RS	Black	3-2303378-1

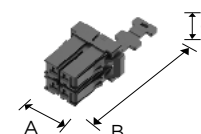

D-3200T Triple-row High Voltage Modular Types – 5.08mm pin pitch

Type Chart

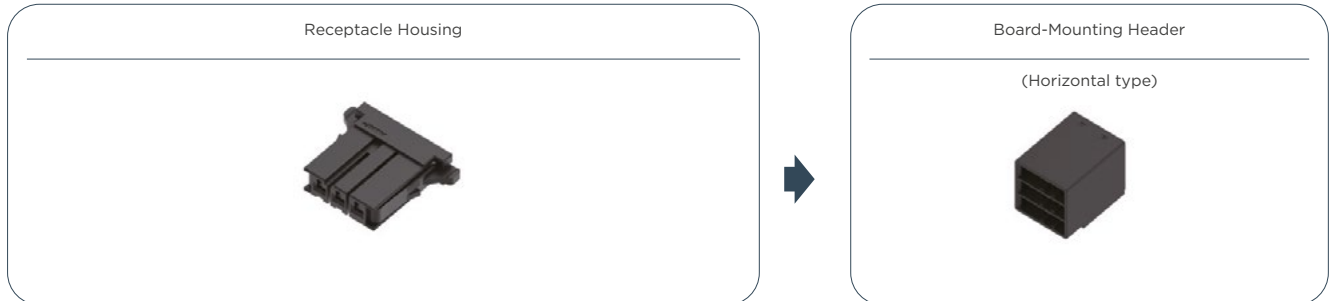

Receptacle Housing (maximum 9 Pos.)					
Single-Row (D-3200S) *1			Double-Row (D-3200M)Single-Row (D-3200S) *1		
POS	KEY	Part Number	POS	KEY	Part Number
3	X	1-178128-3	6	XX	1-178129-6
3	X	1-178128-3			
3	X	1-178128-3	3	X	1-178128-3
3	X	1-178128-3	3	Y	2-178128-3
3	X	1-178128-3	6	XX	1-178129-6
3	Y	2-178128-3			
3	Y	2-178128-3	3	X	1-178129-3
3	Y	2-178128-3	6	YY	2-178129-6
3	X	1-178128-3			
3	X	1-178128-3	3	X	1-178129-3
3	Y	2-178128-3	6	XY	3-178129-6
3	X	1-178128-3			
3	Z	3-178128-3	3	Z	3-178129-3
3	Y	2-178128-3	6	XY	3-178129-6
3	X	1-178128-3			

Board-Mounting Header			
Horizontal type (D-3200T)			
POS	KEY	Plating	Part Number
9	XXX	Gold	1-1123624-2
		Tin	1-1123624-5
9	XXY	Gold	3-1123624-2
		Tin	3-1123624-5
9	YYX	Gold	4-1123624-2
		Tin	4-1123624-5
9	YXX	Gold	5-1123624-2
		Tin	5-1123624-5
9	XYZ	Gold	9-1123624-2

Relative Product Information

Applicable contact...P.48
Performance & Specifications ...P.45
*1 : P.56

Mated Dimension

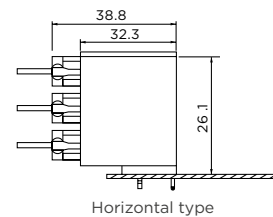

External Dimensions

- Receptacle Housing

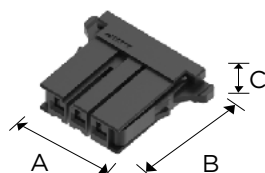

Pos	Key	Color	Part Number	Dimensions		
				A	B	C
3	X	Black	1-178128-3	29.7	22.8	7.2
	Y	Black	2-178128-3			
	Z	Black	3-178128-3			
6	XX	Black	1-178129-6	27.3	22.8	14.8
	YY	Black	2-178129-6			
	XY	Black	3-178129-6			

- Board-Mounting Header

Horizontal type

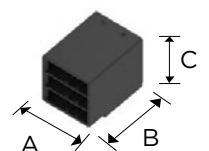

Pos	Key	Plating	Color	Part Number	Dimensions		
					A	B	C
9	XXX	Gold	Black	1-1123624-2	24.2	32.3	27.1
		Tin	Black	1-1123624-5			
	XXY	Tin	Black	3-1123624-5			
		Tin	Black	4-1123624-5			
	YXX	Gold	Black	5-1123624-2			
	XYZ	Gold	Black	9-1123624-2			

NOTE: All products are RoHS compliant On selection.

D-3200T Triple-row High-voltage Modular Type – Key Description

- Board-Mounting Header – horizontal type

Key Type

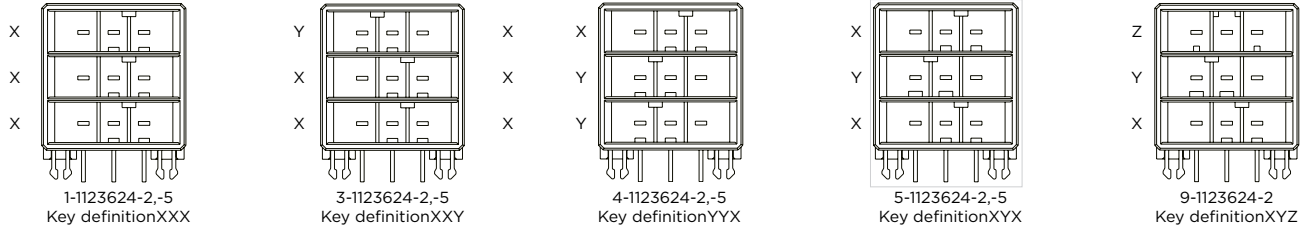

- Receptacle Housing, single-row, double-row

Key Type

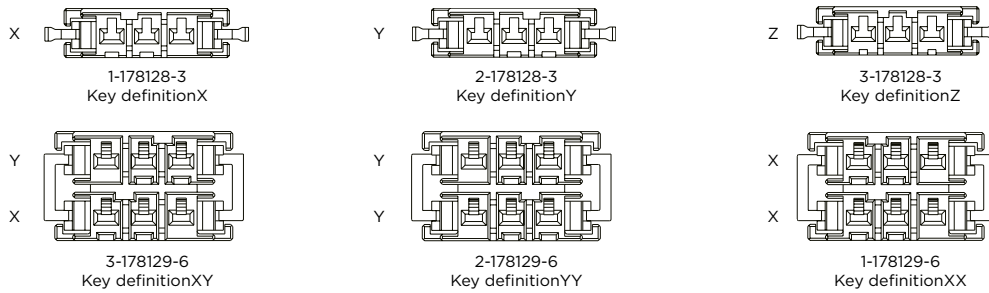

- Application Examples of Key Matching

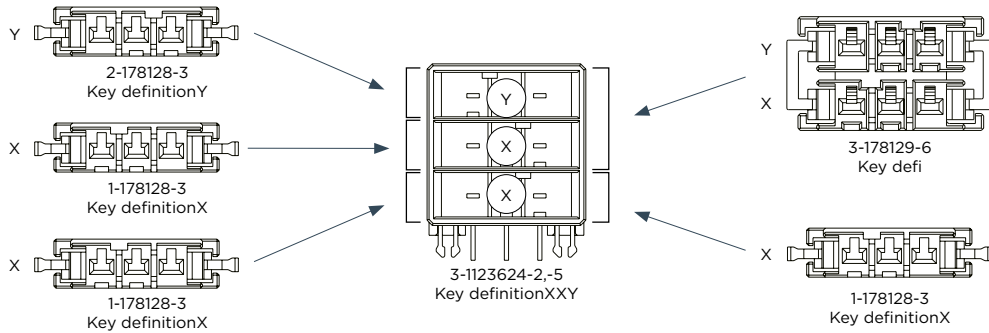

Receptacle Housing (9 positions)					
Single-row (D-3200S) *1			Double-row (D-3200M)		Single-row (D-3200S) *1
Pos	Key	Part Number	Pos	Pos	Part Number
3	X	1-178128-3	6	XX	1-178129-6
	X	1-178128-3	3	X	1-178128-3
	X	1-178128-3	3	Y	2-178128-3
	X	1-178128-3	6	XX	1-178129-6
	Y	2-178128-3	3	X	1-178128-3
	Y	2-178128-3	6	YY	2-178129-6
	X	1-178128-3	3	X	1-178128-3
	Y	2-178128-3	6	XY	3-178129-6
	X	1-178128-3	3	Z	3-178128-3
	Y	2-178128-3	6	XY	3-178129-6
	X	1-178128-3			

Board-Mounting Header			
Horizontal type (D-3200T)			
Pos	Key	Plating	Part Number
9	XXX	Gold	1-1123624-2
		Tin	1-1123624-5
9	XXY	Gold	3-1123624-2
		Tin	3-1123624-5
9	YYX	Gold	4-1123624-2
		Tin	4-1123624-5
9	YYX	Gold	5-1123624-2
		Tin	5-1123624-5
9	XYZ	Gold	9-1123624-2

NOTE: All products are RoHS compliant On selection.

D-3400F Skyscraper Connectors – 3.81mm pin pitch

Type Chart



Pos	Color	Key	Receptacle housing	Tab housing		Plating	Board-Mounting Header	
				Panel type	Free Hanging type		Horizontal type	Vertical type
12	Black	-	178214-1	-	-	Gold	178216-2	-
	Black					Gold	178216-3	
	Black					Tin	178216-5	
20	Black	-	917249-1	-	-	Gold	917251-2	-
	Black					Gold	917251-3	
	Black					Tin	917251-5	

Mated Dimension

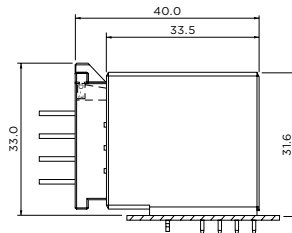

Horizontal type

External Dimensions

- Receptacle Housing

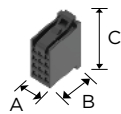

Pos	Key	Color	Part Number	Dimensions		
				A	B	C
12	-	Black	178214-1	12.2	22.8	32.1
20			917249-1	19.8		

- Board-Mounting Header

Horizontal type

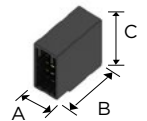

Pos	Key	Plating	Color	Part Number	Dimensions		
					A	B	C
12	-	Gold	Black	178216-2	15.0	33.5	31.6
		Gold	Black	178216-3			
		Tin	Black	178216-5			
20	-	Gold	Black	917251-2	22.6	33.5	31.6
		Gold	Black	917251-3			
		Tin	Black	917251-5			

NOTE: All products are RoHS compliant On selection.

D-3500D Sensor Connector – 5.08mm pin pitch

Type Chart

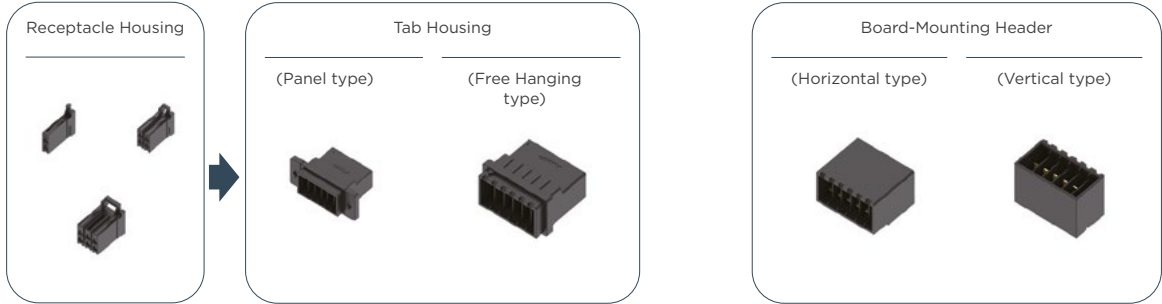

Pos	Color	Key	Receptacle housing	Tab housing			Plating	Board-Mounting Header		
				Panel type	Free Hanging type	L Bracket		Horizontal type	Vertical type	
2	Black	—	175362-1	—	—	—	—	—	—	
			175362-2							
			175362-3							
4	Black	—	175363-1	—	—	—	Gold	1376133-2	—	
	White		1-175363-1							
	Black		175363-2*							
	Blue		2-175363-1							
	Black		175363-3							
6	Black	—	1318095-1	—	—	—	—	—	—	
			1318095-2							
12	Black	—	Possible to use several pieces of 2/4/6 pos receptacle housings with different combination to 12/20 pos.	917241-6 3-917241-6 **	917242-6 3-917242-6 **	—	S	Gold	177555-2	316516-2
								Gold	177555-3	316516-3
								Gold	1-177555-2	—
								Tin	177555-5	316516-5
								Gold	175365-2	316517-2
20	Black	—	Possible to use several pieces of 2/4/6 pos receptacle housings with different combination to 12/20 pos.	917241-8 3-917241-8 **	917242-8 3-917242-8 **	—	S	Gold	175365-3	316517-3
								Tin	175365-5	316517-5

* Small Lever Type
** Triangle mark for position 1

Mated Dimension

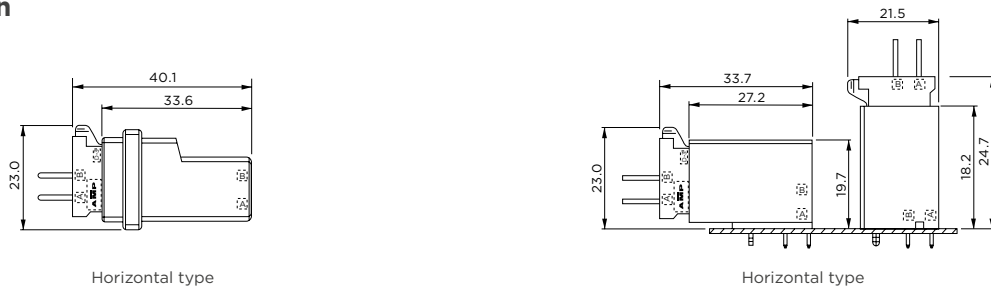

Relative Product Information

Applicable contact...P.48
Performance & Specifications ...P.45
Accessories ...P.126

NOTE: All products are RoHS compliant On selection.

D-3500D Sensor Connector – 5.08mm pin pitch

External Dimensions

- Receptacle Housing

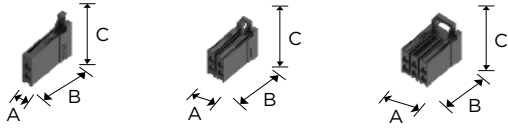

Pos	Key	Color	Part Number	Dimensions		
				A	B	C
2	-	Black	175362-1	4.6	22.8	21.0
		Black	175362-2			
		Black	175362-3			
4	-	Black	175363-1	9.7	22.8	21.0
		White	1-175363-1			
		Blue	2-175363-1			
		Black	175363-2			
6	-	Black	175363-3	14.7	22.8	21.0
		Black	1318095-1			
		Black	1318095-2			

- Tab Housing

Panel type

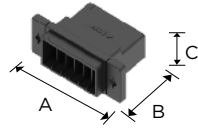

Pos	Key	Color	Part Number	Dimensions		
				A	B	C
12	-	Black	917241-6	52.0	33.6	21.5
		Black	3-917241-6			
20	-	Black	917241-8	72.0	33.6	21.5
		Black	3-917241-8			

Free Hanging type

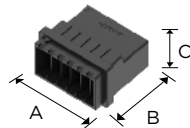

Pos	Key	Color	Part Number	Dimensions		
				A	B	C
12	-	Black	917242-6	36.4	33.6	21.5
		Black	3-917242-6			
20	-	Black	917242-8	56.8	33.6	21.5
		Black	3-917242-8			

- Board-Mounting Header

Horizontal type

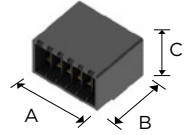

Pos	Key	Plating	Color	Part Number	Dimensions		
					A	B	C
4	-	Black	Black	1376133-2	12.2	27.2	19.7
12			Gold	Black	177555-2		
		Black	Black	177555-3			
			Tin	Black	177555-5		
		20	Gold	Black	1-177555-2		
Black			Black	175365-2			
		Tin	Black	175365-3			
			Tin	Black	175365-5		

Vertical type

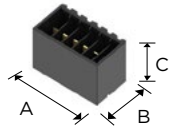

Pos	Key	Plating	Color	Part Number	Dimensions		
					A	B	C
12	-	Gold	Black	316516-2	32.5	18.2	21.6
			Black	316516-3			
		Tin	Black	316516-5			
20	-	Gold	Black	316517-2	52.8	18.2	21.6
			Black	316517-3			
		Tin	Black	316517-5			

NOTE: All products are RoHS compliant On selection.

Spring Clamp Type

The Spring Clamp Type series is a spring clamp type connector applicable to Servo I/O application, etc.

Thanks to the on-site mounting without any crimping tools, working time can be saved significantly.

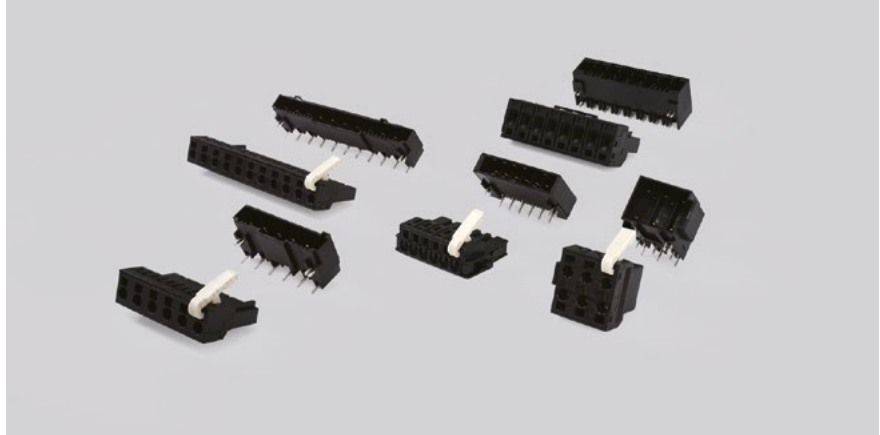

- Adopt the standard wiring method as Dynamic series, and Spring clamp type contacts on receptacle side which comply with UL1059.

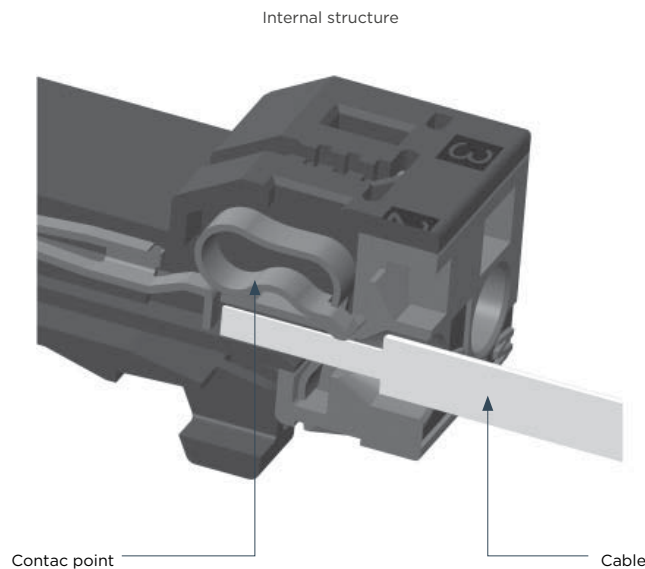

- Applicable to ports of power supply series where a UL508 servo amplifier and inverter, etc. must be used.
- The implementation can be carried out on-site without any crimping tools. Compared to the spiral wiring method, working time is saved significantly.

Product Features

Spring clamp contact

The contact is assembled in housing already with a spring clamp design which provide easy on-site installation, therefore increase the efficiency of assembly.

Audible Latching

Obvious lock sound and feeling when mating means work can be done without mistakes, such as mismatching (halfmating), even if the connection cannot be seen.

Keying

The housing is keyed (with a slit), so differentiating between X keys and Y keys prevents mismatching. It is also possible to make more key patterns by using keying plugs.

Spring Clamp Series Performance and Specifications

Performance

Series	D-2950	D-3950	D-4950	D-5900
Item				
Contact pitch [mm]	5.08	7.5	7.5	13.1
Rated current max. UL [A]	10	14.5	22	42
Rated voltage UL1059 B [V]	300 AC/DC	300 AC/DC	300 AC/DC	—
Rated voltage UL1059 C [V]	—	300 AC/DC	300 AC/DC	600 AC/ DC
Rated voltage UL1059 D [V]	300 AC/DC	600 AC/DC	600 AC/DC	—
Dielectric withstanding Voltage	2,200V AC	2,200V AC	2,200V AC	2200V AC
Wire size [AWG]	18-14	22-14	10-16	16-8
Wire size [mm ²]	0.75-2.0	0.3-2.0	1.25-5.5	1.25-8.0

Performance

Series	D-2950	D-3950	D-4950	D-5900
Item				
Product Specification	108-140221	108-78997	108-140216	108-140022
Application Specification	408-78172	411-78272	408-78173	408-78067

Performance

Description	Material	Finish
Receptacle contact (mating area only)	Copper alloy	0.38μm Gold plating over 1.27μm Nickel under plating
Board-mounting header contact	Copper alloy	Mating area: 0.38μm Gold plating over 1.27μm Nickel under plating Tail area: 2μm TIN plating over 1.27μm Nickel under plating
Receptacle Housing Board-mounting header Housing	Thermoplastic PBT contain glass fiber, UL94V-0,	

Positions / Wire size / Rated current

D-2950 series

No of energized positions	Current(A)				
	AWG14	AWG16	AWG18	AWG20	AWG22
5	11.25	10.5	9.5	8	6.5
6	10.5	9.75	9	7	5.5

D-3950 series

No of energized positions	Current(A)				
	AWG14	AWG16	AWG18	AWG20	AWG22
1	14.5	13.75	13	10.75	8.7
2-5	12.75	11.75	10.25	8.25	7.2
6-11	11.8	9.75	8.75	7	5.5

D-4950 series

No of energized positions	Current(A)			
	AWG10	AWG12	AWG14	AWG16
8	22	19	15	10

D-5900 series

No of energized positions	Current(A)				
	AWG14	AWG16	AWG18	AWG20	AWG22
4	42	30	20	15	10
6	35	30	20	15	10

D-2950 Spring Clamp Type - 5.08mm pin pitch

Type Chart

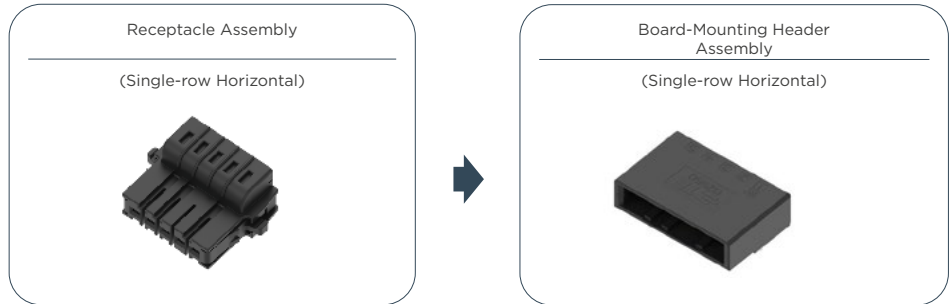

Pos	Key	Color	Circuit mark	Receptacle Assembly	Plating	Board-Mounting Header Assembly
				Single-row Horizontal		Single-row Horizontal
5	X	Black	Yes	1-2347004-5	Gold	1-2347005-5
6	X	Black	Yes	1-2347004-6	Gold	1-2347005-6

Mated Dimension

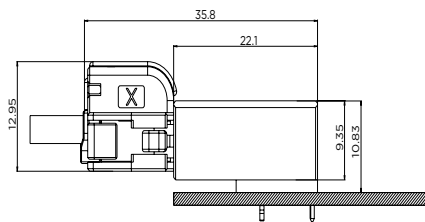

Special auxiliary tools for wire insertion and extraction: 2347681-1

External Dimensions

• Receptacle Assembly

Single-Row Horizontal

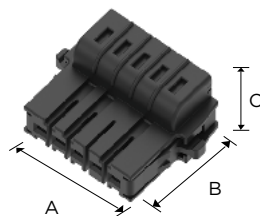

Pos	Key	Plating	Color	Part Number	Dimensions		
					A	B	C
5	X	Gold	Black	1-2347004-5	39.2	29.0	13.0
6				1-2347004-6	44.3		

• Board-Mounting Header Assembly

Single-Row Horizontal

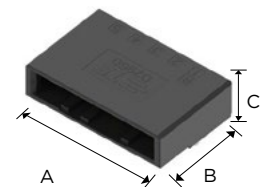

Pos	Key	Plating	Color	Part Number	Dimensions		
					A	B	C
5	X	Gold	Black	1-2347005-5	34.3	22.1	10.9
6				1-2347005-6	39.4		

NOTE: All products are RoHS compliant On selection.

D-3950 Spring Clamp Type – 7.5mm pin pitch

Type Chart

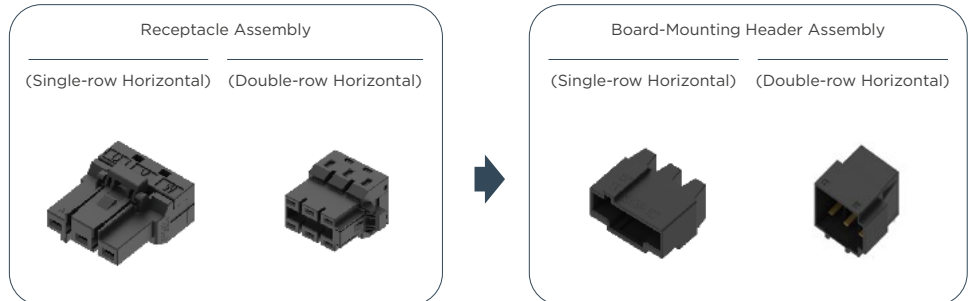

Pos	Color	Key	Circuit mark	Receptacle Assembly		Plating	Board-Mounting Header Assembly			
				Single-row Horizontal	Double-row Horizontal		Single-row Horizontal	Double-row Horizontal		
3	Black	X	Yes	3-2229794-1	—	Gold	3-2229803-1	—		
	Black		No	1-2474564-1		Gold				
4	Black	X	Yes	1-2331743-4		Gold	1-2271457-4			
	Black		No	1-2331743-1						
	Black		Y	No					2-2331743-1	
6	Black	X	No	1-2271454-6		Gold	1-2271457-6			
				1-2475329-6			1-2474029-6			
6	Black	—	Yes	—		2229800-1 2475472-1	Gold		—	2229806-1
* 7	Black	Y	Yes	1-2229794-2		—	Gold		1-2229803-2	—
8	Black	X	Yes	1-2349815-2			Gold		1-2271457-8	
				1-2229794-1	Gold		1-2229803-1			
11	Black	X	Yes	1-2289080-1	Gold	1-2474537-1				
			No	1-2474552-1						

* The 7P connector is a 11P connector with 4 contacts removed.

Mated Dimension

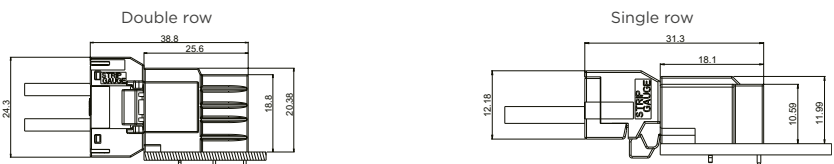

Special auxiliary tools for wire insertion and extraction: 1981045-1

External Dimensions

• Receptacle assembly

Single-Row Horizontal

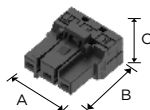

Pos	Key	Plating	Circuit Illustration	Color	Part Number	Dimensions		
						A	B	C
3	X	Gold	Yes	Black	3-2229794-1	22.0	25.4	15.6
		Gold	No	Black	3-2289080-1			
4	X	Gold	Yes	Black	1-2331743-4	27.7		
		Gold	No	Black	1-2331743-1			
		Gold	No	Black	2-2331743-1			
6	X	Gold	No	Black	1-2271454-6	44.5		
* 7	Y	Gold	Yes	Black	1-2229794-2	82.0		
8	X	Gold	Yes	Black	1-2349815-2	57.7		
					1-2229794-1	82.0		
11	X	Gold	Yes	Black	1-2229794-1	82.0		
		Gold	No	Black	1-2289080-1			

* The 7P connector is a 11P connector with 4 contacts removed.

Double-row Horizontal

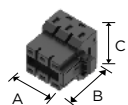

Pos	Key	Plating	Color	Part Number	Dimensions		
					A	B	C
6	—	Gold	Black	2229800-1	25.2	25.6	20.4

NOTE: All products are RoHS compliant On selection.

• Board-Mounting Header Assembly

Single-Row Horizontal

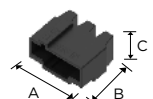

Pos	Key	Plating	Color	Part Number	Dimensions		
					A	B	C
3	X	Gold	Black	3-2229803-1	22.0	18.1	12.0
4	X	Gold	Black	1-2271457-4	29.5		
		Gold	Black	2-2271457-4	29.5		
6	X	Gold	Black	1-2271457-6	44.5		
* 7	Y	Gold	Black	1-2229803-2	82.0		
8	X	Gold	Black	1-2271457-8	59.5		
11	X	Gold	Black	1-2229803-1	82.0		

* The 7P connector is a 11P connector with 4 contacts removed.

Double-row Horizontal

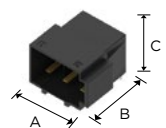

Pos	Key	Plating	Color	Part Number	Dimensions		
					A	B	C
3	X	Gold	Black	2229806-1 2470382-1	22.0	18.1	12.0

D-4950 Spring Clamp Type - 7.5mm pin pitch

Type Chart

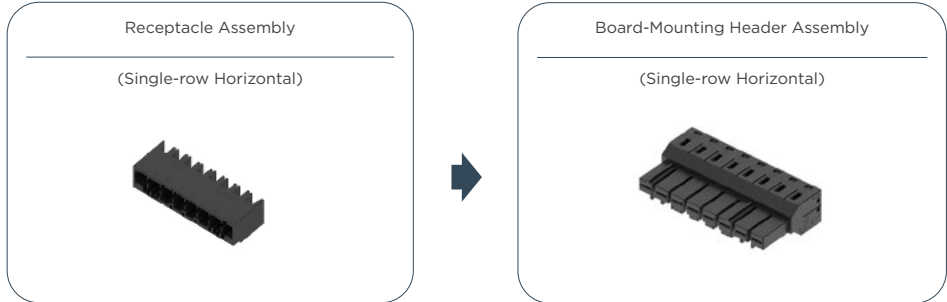

Pos	Color	Key	Circuit mark	Receptacle Assembly	Plating	Board-Mounting Header Assembly
				Single-row Horizontal		Single-row Horizontal
8	Black	X	Yes	1-2349849-8	Gold	1-2349825-8

Mated Dimension

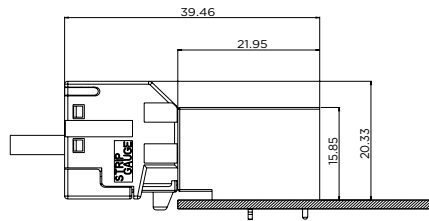

Special auxiliary tools for wire insertion and extraction: 2349891-1

External Dimensions

- Receptacle assembly
Single-Row Horizontal

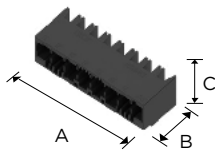

Pos	Key	Plating	Color	Part Number	Dimensions		
					A	B	C
8	X	Gold	Black	1-2349849-8	61.5	31.7	22.1

- Board-Mounting Header Assembly
Single-Row Horizontal

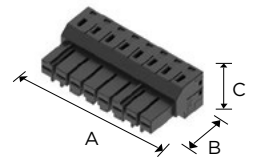

Pos	Key	Plating	Color	Part Number	Dimensions		
					A	B	C
8	X	Gold	Black	1-2349825-8	61.5	22.0	15.9

NOTE: All products are RoHS compliant On selection.

D-5900 Field Wiring Type - 13.1 mm pin pitch

Type Chart

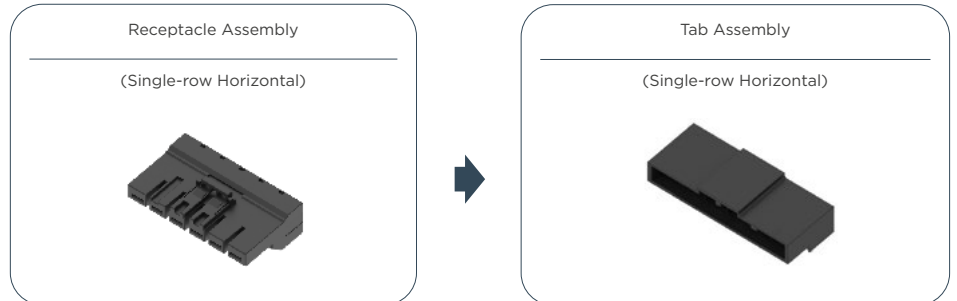

Pos	Color	Key	Circuit Mark	Receptacle Assembly	Plating	Tab Assembly
				Single-row horizontal type		Single-row horizontal type
4	Black	X	Yes	4-2260663-1	Gold	4-2260661-1
4		Y		4-2260663-2	Gold	4-2260661-1
6		X		6-2260663-1	Gold	6-2260661-1

Mated Dimension

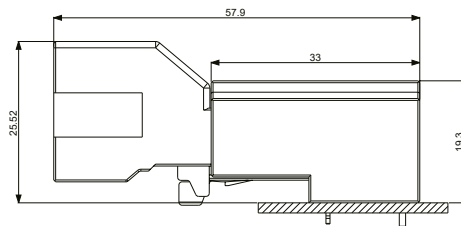

Special auxiliary tools for wire insertion and extraction: 2260828-1

External Dimensions

- Receptacle assembly
Single-Row Horizontal

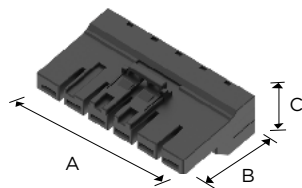

Pos	Key	Plating	Color	Part Number	Dimensions		
					A	B	C
4	X	Gold	Black	4-2260663-1	52.9	45.9	25.9
4	Y	Gold	Black	4-2260663-2			
6	X	Gold	Black	6-2260663-1	79.1		

- Tab Assembly
Single-Row Horizontal

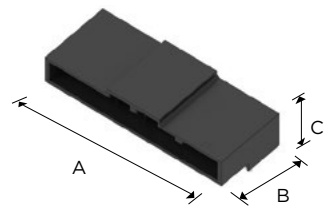

Pos	Key	Plating	Color	Part Number	Dimensions		
					A	B	C
4	X	Gold	Black	4-2260661-1	57.6	33	19.3
4	Y	Gold	Black	4-2260661-1			
6	X	Gold	Black	6-2260661-1	83.8		

NOTE: All products are RoHS compliant On selection.

On-site Push-in Type

The On-site push-in type series is applicable to the power input and output of servo control systems.

The compact size saves space on the board and facilitates the high-density design of the board. The vertically plugging design and the newly added cable unplugging button make the “tool-free” on-site mounting possible.

The high temperature housing material applicable to reflow soldering and the economical version enrich the choice of connectors for the servo application.

The On-site push-in type series inherits the Dynamic’s high reliability, audible & tactile locking system and key design to provide a more efficient solution for the installation process.

Product Features

1. Release button design

On-site Push-in type has a release button design, which could support wire inserting and removing of the connector, therefore achieving toolless assembly.

2.Spring clamp contact

The contact is assembled in housing already with a spring clamp design which provide easy on-site installation, therefore increase the efficiency of assembly.

3.High temperature housing material

Housing is made of high temperature material, therefore withstand reflow soldering process.

4. Three different Header options

Three different Headers-including horizontal header, vertical header and reversed header-which fit to varies of application needs.



- Adopt the standard wiring method as Dynamic series, and Spring clamp type contacts on receptacle side which comply with UL1059.

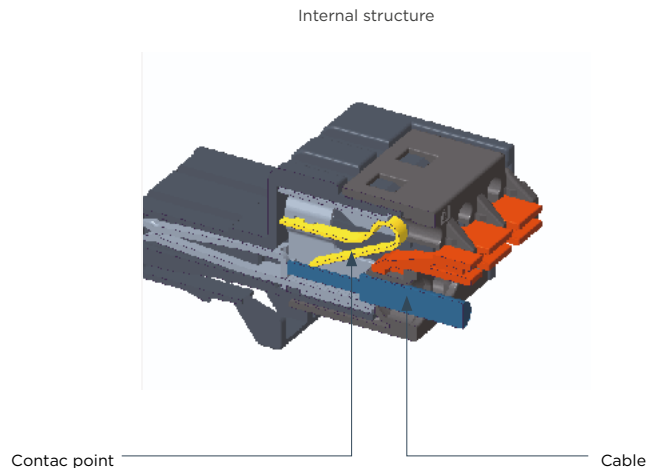

- Applicable to ports of power supply series where a UL508 servo amplifier and inverter, etc. must be used.
- The implementation can be carried out on-site without any crimping tools. Compared to the spiral wiring method, working time is saved significantly.

5. Two plating types

Both gold plating and tin plating contacts balance the high reliability and economical requests.

6.Center locking

This is the first application of a center lock in Dyamic series. On-board space requirements can be mounted in a tight space for high-density mounting on boards requiring signal lines.

7.Audible Latching

Obvious lock sound and feeling when mating means work can be done without mistakes, such as mismating (halfmating), even if the connection cannot be seen.

Spring Clamp Series Performance and Specifications

Performance

Item	Series	D-2970
Contact pitch [mm]		5.0
Rated current max. UL [A]		10 (AWG14 x 1)
Rated voltage UL1059 B [V]		20 (AWG14 x 1)
Rated voltage UL1059 C [V]		300 AC/DC
Rated voltage UL1059 D [V]		400 AC/DC
Dielectric withstanding Voltage		2,200V AC
Wire size [AWG]		18-14
Wire size [c]		0.75-2.0

Product Specifications

Item	Series	D-2970
Product manual		108-140223
Operation manual		408-78171

Positions / Wire size / Rated current

D-2970 Series

Pos	Current(A)						
	AWG 26	AWG 24	AWG 22	AWG 20	AWG 18	AWG 16	AWG 14
3	4.5	5.5	7	8	9.5	11.5	15
4	4	4.5	6	7.5	9	11.5	14
Reference UL1059Limit	1	2	3	5	7	10	15

When spec is over UL1059 limit, UL1059 requirement equipment shall use Limit current.

Materials and Plating

Description	Material	Finisher
Receptacle contact (Only at the contactpoint)	Copper alloy	1.0 µm Tin plating over 1.27 µm Nickel under-plated
Board-mounting header contact	Copper alloy	Mating area: 2.5 µm Tin plating over 1.27 µm Nickel under-plated Tail area: 2 µm Tin plating over 1.27 µm Nickel under-plated
Receptacle Housing Board-mounting header Housing		Liquid Crystal Plastic (LCP), UL94V-0

D-2970 On-site Push-in Type - 5.0mm pin pitch

Type Chart

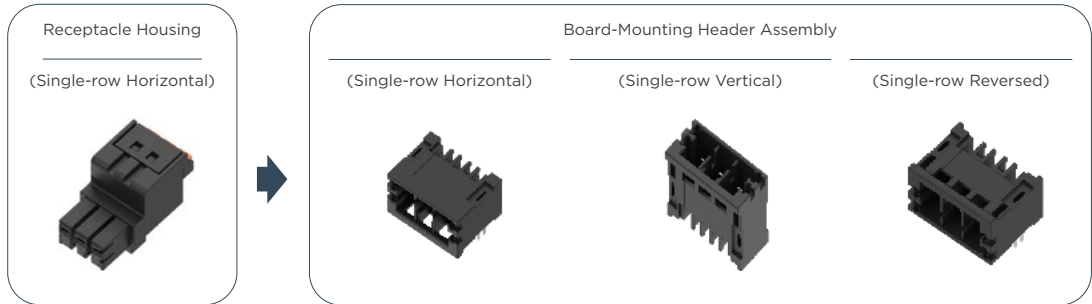

Pos	Color	Key		Receptacle Assembly		Board Mounting Header Assembly		
				Single-Row Horizontal	Single-Row Horizontal	Single-row Vertical	Single-row Reversed	
3	Black	X	Tin	2336488-3	2336490-3	2336494-3	2336491-3	
3	Black	X	Gold	2-2336488-3	2-2336490-3	2-2336494-3	2-2336491-3	
4	Black	X	Tin	2336488-4	2336490-4	2336494-4	2336491-4	
4	Black	X	Gold	2-2336488-4	2-2336490-4	2-2336494-4	2-2336491-4	

Mated Dimension

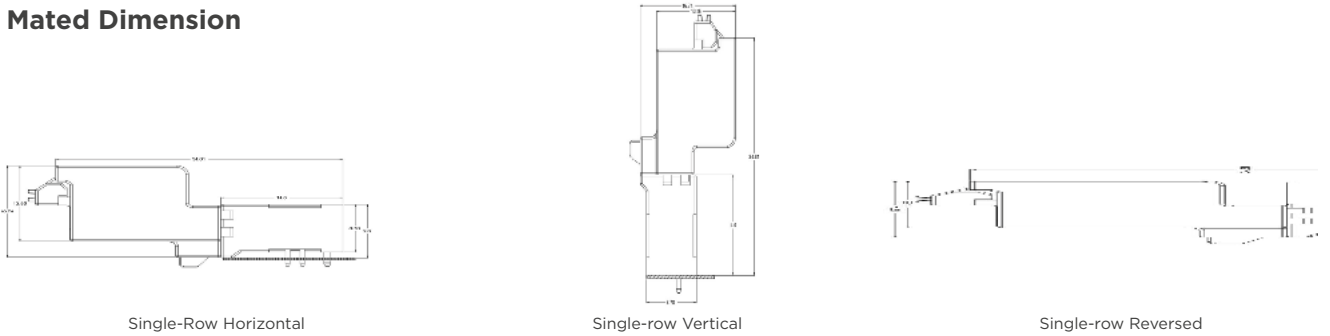

External Dimensions

• Receptacle Assembly

Single-Row Horizontal

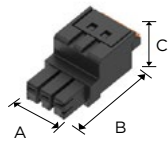

Pos	Key	Plating	Color	Part Number	Dimensions		
					A	B	C
3	X	Tin	Black	2336488-3	17	34	18.7
3	X	Gold	Black	2-2336488-3			
4	X	Tin	Black	2336488-4	22	34	18.7
4	X	Gold	Black	2-2336488-4			

• Board-Mounting Header Assembly

Single-Row Horizontal

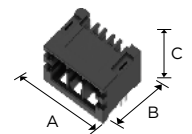

Pos	Key	Plating	Color	Part Number	Dimensions		
					A	B	C
3	X	Tin	Black	2336488-3	17	34	18.7
3	X	Gold	Black	2-2336488-3			
4	X	Tin	Black	2336488-4	22	34	18.7
4	X	Gold	Black	2-2336488-4			

Single-Row Vertical

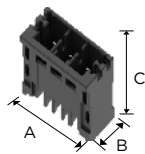

Pos	Key	Plating	Color	Part Number	Dimensions		
					A	B	C
3	X	Tin	Black	2336494-3	19.9	9.8	14.8
3	X	Gold	Black	2-2336494-3			
4	X	Tin	Black	2336494-4	24.9	9.8	14.8
4	X	Gold	Black	2-2336494-4			

Single-Row Reversed

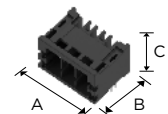

Pos	Key	Plating	Color	Part Number	Dimensions		
					A	B	C
3	X	Tin	Black	2336491-3	19.9	14.8	9.8
3	X	Gold	Black	2-2336491-3			
4	X	Tin	Black	2336491-4	24.9	14.8	9.8
4	X	Gold	Black	2-2336491-4			

NOTE: All products are RoHS compliant On selection.

Tap Connector: Dyna-Tap Connectors

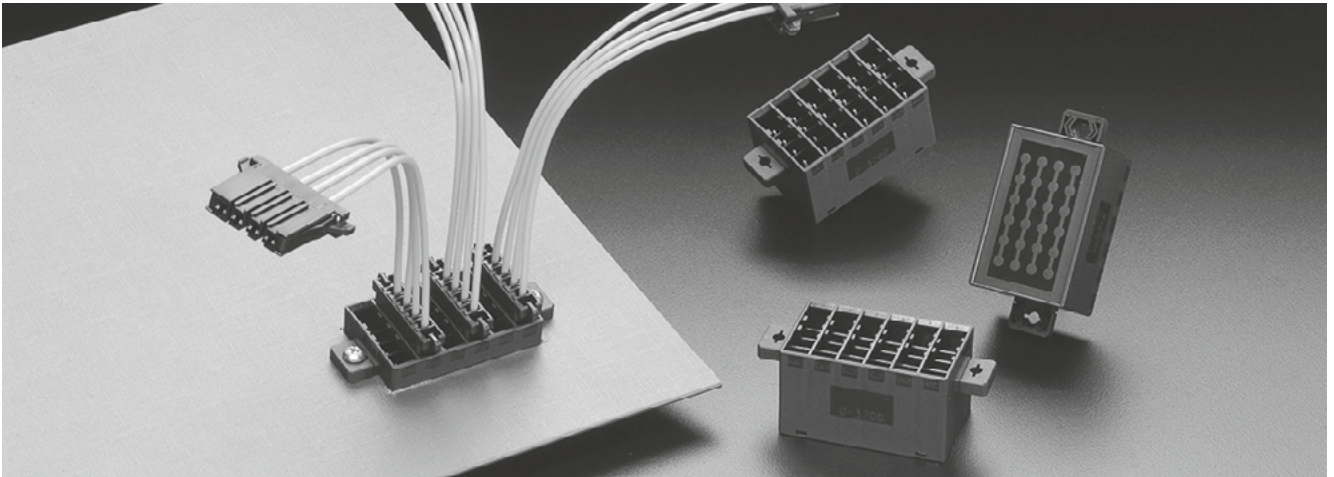

Tap Connector: Dyna-Tap Connectors

The common FA equipment is a device formed by combining functionally separated units in a final process. Tap on the circuit board was the original method used for supplying power to each unit.

Therefore, TE developed a tap connector with tap function—Dyna-Tap, which will not further burden the circuit board of which the space should be further saved in the future.

Dyna-Tap Connectors is a Dynamic series tap connector developed as an FA power connector, so it is the most suitable product for tap of the main power cable. (An application has been made for the design of its appearance)

Its specification is 6P to support the tap of the 3-phase power cable system widely used in the industry.

The relay type and panel type of the product has been developed. The matching model is 1-178288-6.

D-3100 Dyna-Tap18P(6Px3ROW)

Highlight

Since in most applications it is fixed outside the circuit board (chassis), a dust cover is installed to prevent dust from entering the inside of the housing. Therefore, it can be used in harsh environments.

Application

- Power tap in the elevator control room
- Power tap of power protection relays, etc.
- Power tap in the semiconductor production equipment unit room
- Power supply for production line equipment

Performance

- Rated voltage: 250V AC/DC
- Rated current: : 8A (when the 18P and AWG#14 are used)
- No of Pos.: 6Px3 = 18P (6P tap)
- Durability 500 cycles
- Product standard: 108-5754

D-3200 Dyna-Tap24P(4Px6ROW)

Highlight 1

The Dynamic series connectors and contacts can be used. It is a power supply board that uses the Dynamic series (D-3200S 4P REC) with excellent connection reliability and gain high reputation. Compared to terminal blocks, its installation and maintenance costs are reduced significantly. Meanwhile, compatible terminals enable less costs of use and inventory.

Highlight 2

Positions of Power board installation can be set freely. Considering that the relay type

and panel type connectors are used jointly, panel type with fixtures near to opener or buttom are both available.

Highlight 3

Cost advantage by reducing number of components used and saving working hours on installation.

Other highlights

- The Tin plated and Gold-plated type (0.38 μm) are provided.
- The back is engraved with an electrical connection diagram.

D-3100 Dyna-Tap 18P (6Px3ROW), 24P (6Px4ROW) - 3.81mm pin pitch

Type Chart

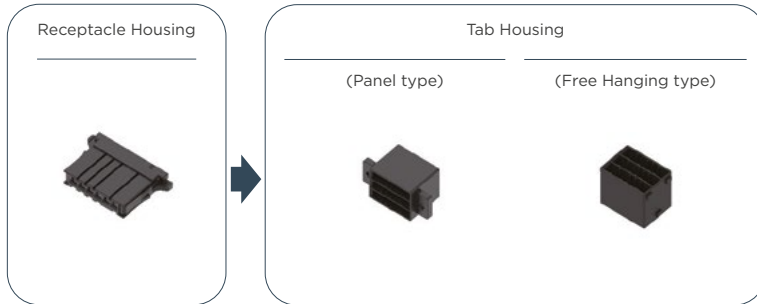

Pos	Color	Key	Receptacle housing	Tab housing		Through-hole	Plating	Board-Mounting Header	
				Panel type	Free Hanging type			Horizontal type	Vertical type
6	Black	X	1-178288-6	—	—	—	—	—	—
18	Black	X	—	1376807-2	1376807-1	—	—	—	—
24	Black	X	—	—	—	1971003-1	—	—	—
	Black	X				1971003-2			

Mated Dimension

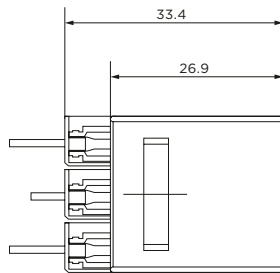

External Dimensions

- Receptacle Assembly

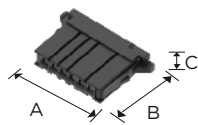

Pos	Key	Color	Part Number	Dimensions		
				A	B	C
6	X	Black	1-178288-6	38.2	22.8	7.2

Through-hole

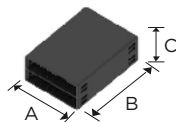

The circuit schematic is provided in the side of the product schematic above

Pos	Key	Color	Part Number	Dimensions		
				A	B	C
24	X	Black	1971003-1	33.1	45.7	17.1
			1971003-2	35.1		35.1

- Tab housing

Panel type

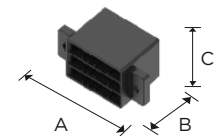
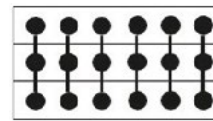

Pos	Key	Plating	Color	Part Number	Dimensions		
					A	B	C
18	X	Gold	Black	1376807-2	51.0	26.9	24.6

Free Hanging type

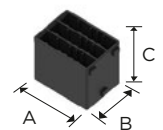

Pos	Key	Plating	Color	Part Number	Dimensions		
					A	B	C
18	X	Gold	Black	1376807-1	33.1	24.6	26.9

NOTE: All products are RoHS compliant On selection.

D-3200 Dyna-Tap 24P (4Px6ROW) – 5.08 mm pin pitch

Type Chart

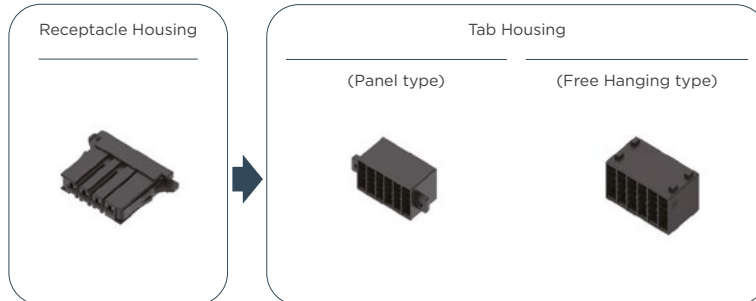

Pos	Color	Key	Receptacle housing	Tab housing		Plating	Board-Mounting Header	
				Panel type	Free Hanging type		Horizontal type	Vertical type
4	Black	X	1-178128-4	—	—	—		
24	Black	X	—	1827691-2*1	1827691-1	Gold	—	—
	Black	X		1-1827691-2*1	1-1827691-1	Tin		
	Black	X		1827691-3*2	—	Gold		
	Black	X		1-1827691-3*2	—	Tin		

* 1 Front panel type * 2 Bottom panel type

Mated Dimension

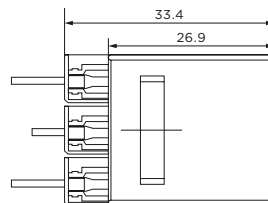

Panel type/Free Hanging type

External Dimensions

- Receptacle Housing

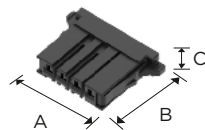

Pos	Key	Color	Part Number	Dimensions		
				A	B	C
4	X	Black	1-178128-4	24.6	22.8	7.2

- Board-Mounting Header

Panel type

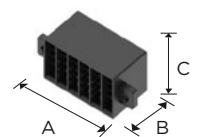
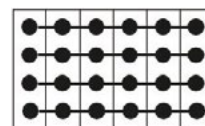

Pos	Key	Plating	Color	Part Number	Dimensions		
					A	B	C
24	X	Gold	Black	1827691-2	65.0	26.9	29.2
	X	Tin	Black	1-1827691-2			
	X	Gold	Black	1827691-3			
	X	Tin	Black	1-1827691-3			

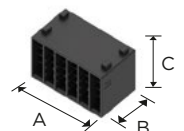

Free Hanging type

Pos	Key	Plating	Color	Part Number	Dimensions		
					A	B	C
24	X	Gold	Black	1827691-1	47.5	26.9	29.2
		Tin	Black	1-1827691-1			

NOTE: All products are RoHS compliant On selection.

D-4000 Series

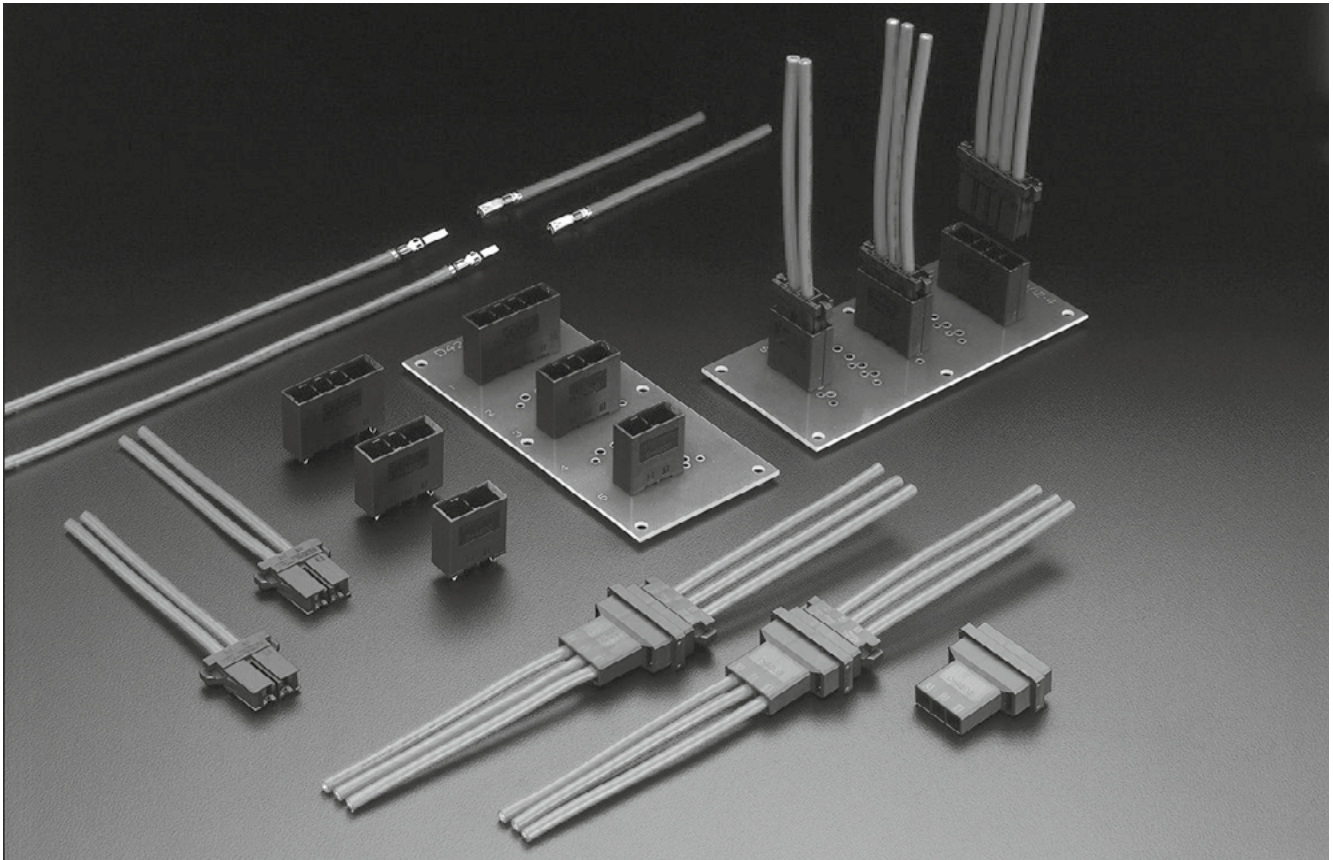

Series introduction

It is a connector most appropriate for industrial equipment equipped with 20A power cords. The optimum size meets the compactness and high current requirements of the equipment.

The terminal is newly designed to have 4 contact points.

Compared with the Dynamic3000 series, it can ensure a current of above 50% while only increase 14% in mated height, so that miniaturization is achieved.

Compared to existing products, each positions has a current capacity increased by about 32%.

Product Features

1. Small Size/High Current Contact

The contacts are newly-designed with 4 points of contact. This allows significantly improved current capacity (rated 20A maximum) as well as reliability.

2. The sequential contacts

The sequential contact is a longer tab contact. When used in connection with the regular contacts it provides a ground that mates before the other power contacts.

3. High current contact

New V shape contact were developed for mounting on boards with larger contact area while

smaller through-holes. Even though a lot of on-board connection space is needed, through-holes were made as small as possible to make pattern design easily.

4. Audible Latching

On mating, an audible lock sound and sensation is transmitted to the assembler, so that even when working 'blind' mis-mating (or half-mating) problems are avoided.

5. Key

The housing has a keying (slit), so that by separating use of the X key and Y key mis-Mating is prevented.

D-4000 Series Performance and Specifications

Performance

Item \ Pitch	250mils 6.35mm
Rated Voltage	600V AC(rms)/DC
Rated Current	2P: 24A3P: 23A4P: 22A(AWG#12 for use as powersource)
Contact Resistance	10mΩ max
Withstanding Voltage	2,500V AC(1 min)
Operating Temperature	-55°C --+105°C

Positions / Wire size / Rated current

Position	Wire Size(AWG)		
	12	14	16
2	24	21	16
3	23	20	15
4	22	19	14

Unit: A(Amps)

Product Specifications

Product Specifications	108-78182	
Applications Specifications	114-5369	
Hand tool application specification	Part number: 1762130-1 (M)	411-78174
	Part number: 1762129-1 (L)	411-78173
Unplugging tool (1762461-1) operating manual	411-78186	

When applicable, please be sure to order the operating manual. It can also be found in the online electronic specifications catalog.

Materials and Plating

Category	Materials	Plating
Receptacle Contact Tab Contact	Phosphor bronze or copper alloy	0.38μm gold-plating over Nickel under-plated
Board Mount Header	Phosphor bronze or copper alloy	Gold plating over Nickel under-plated Tin plating on tail side
Housing	UL94V-0, reinforced thermoplastic PBT with glass fiber	

Safety Standards

The safety specifications listed below are approved on specific part numbers. Please contact our Technical Support Centre to check whether the part numbers you use are approved or not. Keep in mind that there are instances where values differ from those given by Tyco Electronics Specifications.

Standard	Series	D-4200										
	Rated Voltage	Rated Current	Temperature Range									
Product Specifications 108-78182	600V AC/DC	24A AWG#12 2P	-55°C --+105°C									
UL File No.E28476	Based on the requirements of Application	Based on the requirements of Application	—									
TÜV License No. R 50084673	600V AC/DC	<table border="1"> <thead> <tr> <th>AWG</th> <th>A(2 P)</th> </tr> </thead> <tbody> <tr> <td>12</td> <td>24</td> </tr> <tr> <td>14</td> <td>21</td> </tr> <tr> <td>16</td> <td>16</td> </tr> </tbody> </table>	AWG	A(2 P)	12	24	14	21	16	16	-55°C --+105°C	
AWG	A(2 P)											
12	24											
14	21											
16	16											

D-4000 Series Configurations

D-4200S

High Current

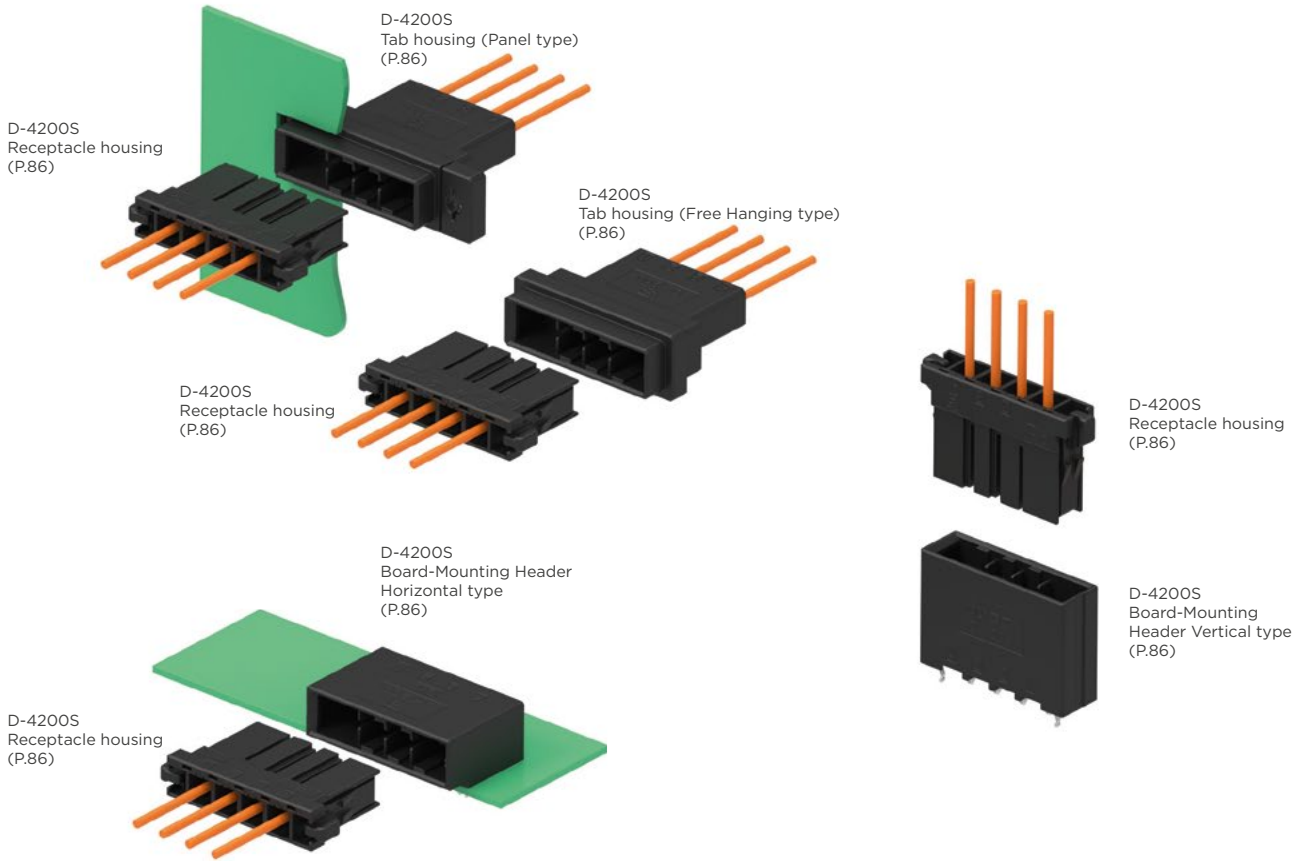

D-4200M

High Current Modular Type

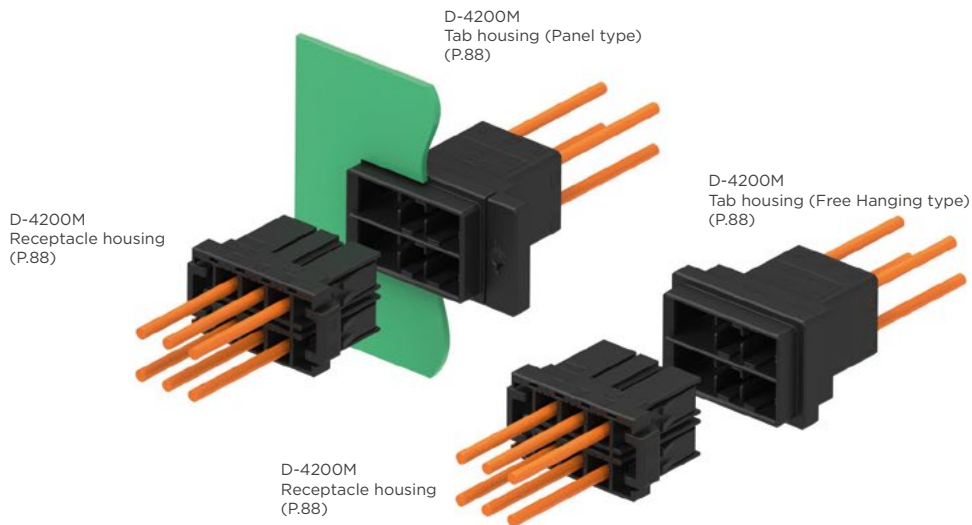

D-4000 Series Contact

Crimped Types

(Gold plating thickness 0.38 µm)



Receptacle Contact
(Used in Receptacle housing)



Tab contact
(Used in Tab housing)

Wire Range		Outside Diameter of Insulation mm	Wire Range Mark	Contacts						Applicable tools	
AWG	mm ²			Receptacle Contact		Tab Contact		Sequential LongTab contacts		Hand tool CCII hand tool PEW12 hand tool* PEW12 dice only	Mini-Applicator
				Strip form	Loose Piece	Strip form	Loose Piece	Strip form	Loose Piece		
22	0.30	1.58-2.38	SS*	2287721-2	2288020-1	2287732-2	2288019-1	1-2287732-2	1-2288019-1	—	—
20	0.50	1.76-2.56		2040015-2	2040587-1	2040016-2	2040586-1	1-2040016-1	1-2040586-1	2266289-1	2047670-1
20	0.50	1.8-2.7	S	1747418-2	1747499-2	1747419-2	1747501-2	1-1747419-2	1-1747501-2	1762130-1	1762120-2
18	0.85									2.8-3.75	
16	1.42	2.4-3.2	L	1747415-2	1747498-2	1747416-2	1747500-2	1-1747416-2	1-1747500-2	1762129-1	1762119-2
16	1.25	2.0-3.2								M	
14	2.20	2.9-3.8	L	1747415-2	1747498-2	1747416-2	1747500-2	1-1747416-2	1-1747500-2	1762129-1	1762119-2
12	3.50	3.8-4.2								1762670-1* (1762674-1)	

Note: *Corresponding terminal's gold plating thickness is 0.76 µm, and that of the corresponding terminal without wire diameter and type is 0.38 µm.

Please contact our sales department or distributor for more information.

Strip Form contacts are used with Mini-applicators (bench machine) and Loose-Piece contacts are with hand tools.

PEW 12 is an exchange-type hand tool. *refers to the exchange-type hand tool with product number - 9-1478240-0

The receptacle contact can be used in all receptacle housings, the tab contact can be used in all tab housings. Details of the applicable tool are available from P.106-110.

NOTE: All products are RoHS compliant On selection.

D-4200S Single-row High Voltage – 6.35mm pin pitch

Type Chart



Pos	Color	Key	Receptacle housing	Tab housing		Plating	Board-Mounting Header			
				Panel type	Free Hangingtype		Horizontal type		Vertical type	
							Standard	Sequential	Standard	Sequential
2	Black	X	1-1747276-2	1-1747535-2	1-1747414-2	Gold	1-1903328-2	—	1-1747277-2	—
	Black	Y	2-1747276-2	2-1747535-2	2-1747414-2	Gold	2-1903328-2	—	2-1747277-2	—
3	Black	X	1-1747276-3	1-1747535-3	1-1747414-3	Gold	1-1903328-3	5-1903328-3	1-1747277-3	5-1747277-3
	Black	Y	2-1747276-3	2-1747535-3	2-1747414-3	Gold	2-1903328-3	6-1903328-3	2-1747277-3	6-1747277-3
4	Black	X	1-1747276-4	1-1747535-4	1-1747414-4	Gold	1-1903328-4	5-1903328-4	1-1747277-4	5-1747277-4
	Black	Y	2-1747276-4	2-1747535-4	2-1747414-4	Gold	2-1903328-4	6-1903328-4	2-1747277-4	6-1747277-4

Relative Product Information

Applicable contact...P.85

Performance & Specifications...P.83

Applications

- Example of Robot/Robot Controller Application

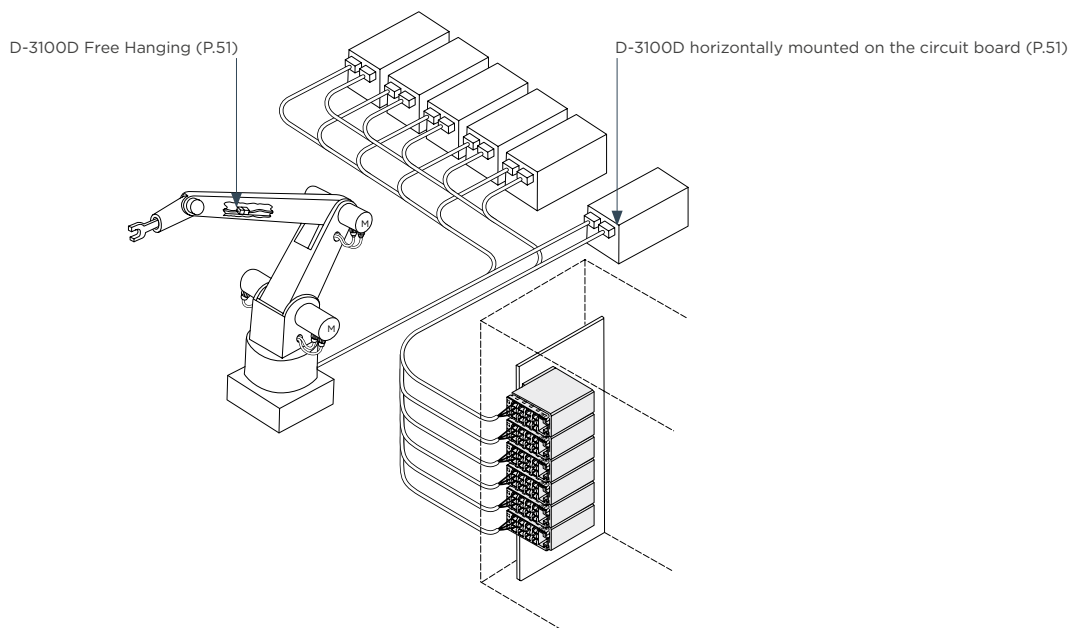

NOTE: All products are RoHS compliant On selection.

D-4200S Single-row High Voltage – 6.35mm pin pitch

Mated Dimension

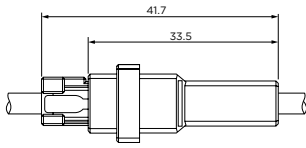

Panel type/Free Hanging type

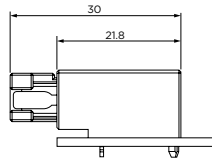

Horizontal type

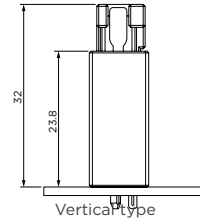

Vertical type

External Dimensions

- Receptacle Housing

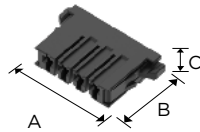

Pos	Key	Color	Part Number	Dimensions		
				A	B	C
2	X	Black	1-1747276-2	27.4	23.0	8.5
	Y	Black	2-1747276-2			
3	X	Black	1-1747276-3	33.7	23.0	8.5
	Y	Black	2-1747276-3			
4	X	Black	1-1747276-4	40.1	23.0	8.5
	Y	Black	2-1747276-4			

- Tab Housing

Panel type

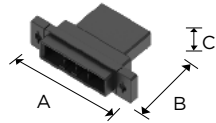

Pos	Key	Color	Part Number	Dimensions		
				A	B	C
2	X	Black	1-1747535-2	40.0	33.5	13.8
	Y	Black	2-1747535-2			
3	X	Black	1-1747535-3	46.0	33.5	13.8
	Y	Black	2-1747535-3			
4	X	Black	1-1747535-4	53.0	33.5	13.8
	Y	Black	2-1747535-4			

Free Hanging type

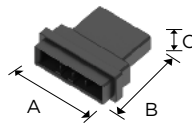

Pos	Key	Color	Part Number	Dimensions		
				A	B	C
2	X	Black	1-1747535-2	40.0	33.5	13.8
	Y	Black	2-1747535-2			
3	X	Black	1-1747535-3	46.0	33.5	13.8
	Y	Black	2-1747535-3			
4	X	Black	*1-1747535-4	53.0	33.5	13.8
	Y	Black	*2-1747535-4			

*DIN rail attachment is available. P/N : 2822901-1
Applicable P/N : Δ-1747414-4

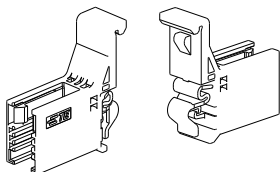

- Board-Mounting Header

Horizontal type

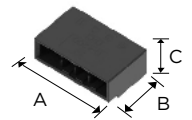

Pos	Key	Plating	Color	Part Number	Dimensions		
					A	B	C
2	X	Gold	Black	1-1903328-2	22.4	21.8	11.9
	Y	Gold	Black	2-1903328-2			
3	X	Gold	Black	1-1903328-3	28.7	21.8	11.9
	Y	Gold	Black	2-1903328-3			
4	X	Gold	Black	5-1903328-3*1	35.1	21.8	11.9
	Y	Gold	Black	6-1903328-3*1			
	X	Gold	Black	1-1903328-4			
	Y	Gold	Black	2-1903328-4			
4	X	Gold	Black	5-1903328-4*1	35.1	21.8	11.9
	Y	Gold	Black	6-1903328-4*1			

*1 Sequential

Vertical type

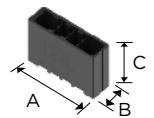

Pos	Key	Plating	Color	Part Number	Dimensions		
					A	B	C
2	X	Gold	Black	1-1747277-2	22.4	10.4	23.8
	Y	Gold	Black	2-1747277-2			
3	X	Gold	Black	1-1747277-3	28.7	10.4	23.8
	Y	Gold	Black	2-1747277-3			
4	X	Gold	Black	5-1747277-3*1	35.1	10.4	23.8
	Y	Gold	Black	6-1747277-3*1			
	X	Gold	Black	1-1747277-4			
	Y	Gold	Black	2-1747277-4			
4	X	Gold	Black	5-1747277-4*1	35.1	10.4	23.8
	Y	Gold	Black	6-1747277-4*1			

*1 Sequential

D-4200M Double-row High Current Modular Type - 6.35mm pin pitch

Type Chart

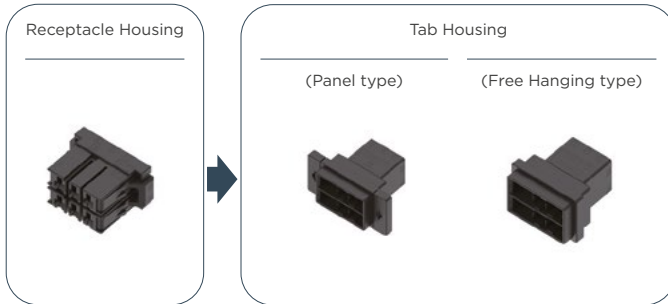

Pos	Color	Key	Receptacle housing	Tab housing		Plating	Board-Mounting Header	
				Panel type	Free Hanging type		Horizontal type	Vertical type
6	Black	XX	1-1903329-3	1-1903331-3	1-1903330-3	-	-	-
	Black	YY	2-1903329-3	2-1903331-3	2-1903330-3			
	Black	XY	3-1903329-3	3-1903331-3	3-1903330-3			
8	Black	XX	1-2390394-4	1-2390395-4	-			

Relative Product Information

Applicable contact...P.85
Performance & Specifications...P.83

Mated Dimension

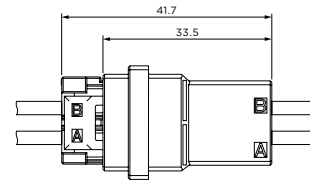

Panel type/Free Hanging type

External Dimensions

- Receptacle Housing

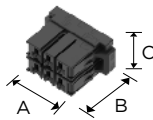

Pos	Key	Color	Part Number	Dimensions		
				A	B	C
6	XX	Black	1-1903329-3	33.7	23.0	17.3
	YY	Black	2-1903329-3			
	XY	Black	3-1903329-3			
8	XX	Black	1-2390394-4	40.1	23.0	

- Tab housing

Panel type

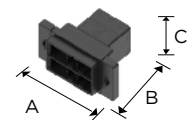

Pos	Key	Color	Part Number	Dimensions		
				A	B	C
6	XX	Black	1-1903331-3	46.0	33.5	22.6
	YY	Black	2-1903331-3			
	XY	Black	3-1903331-3			
8	XX	Black	1-2390395-4	52.4		

Free Hanging type

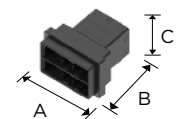

Pos	Key	Color	Part Number	Dimensions		
				A	B	C
6	XX	Black	1-1903330-3	32.7	33.5	22.6
	YY		2-1903330-3			
	XY		3-1903330-3			

NOTE: All products are RoHS compliant On selection.

D-5000 Series

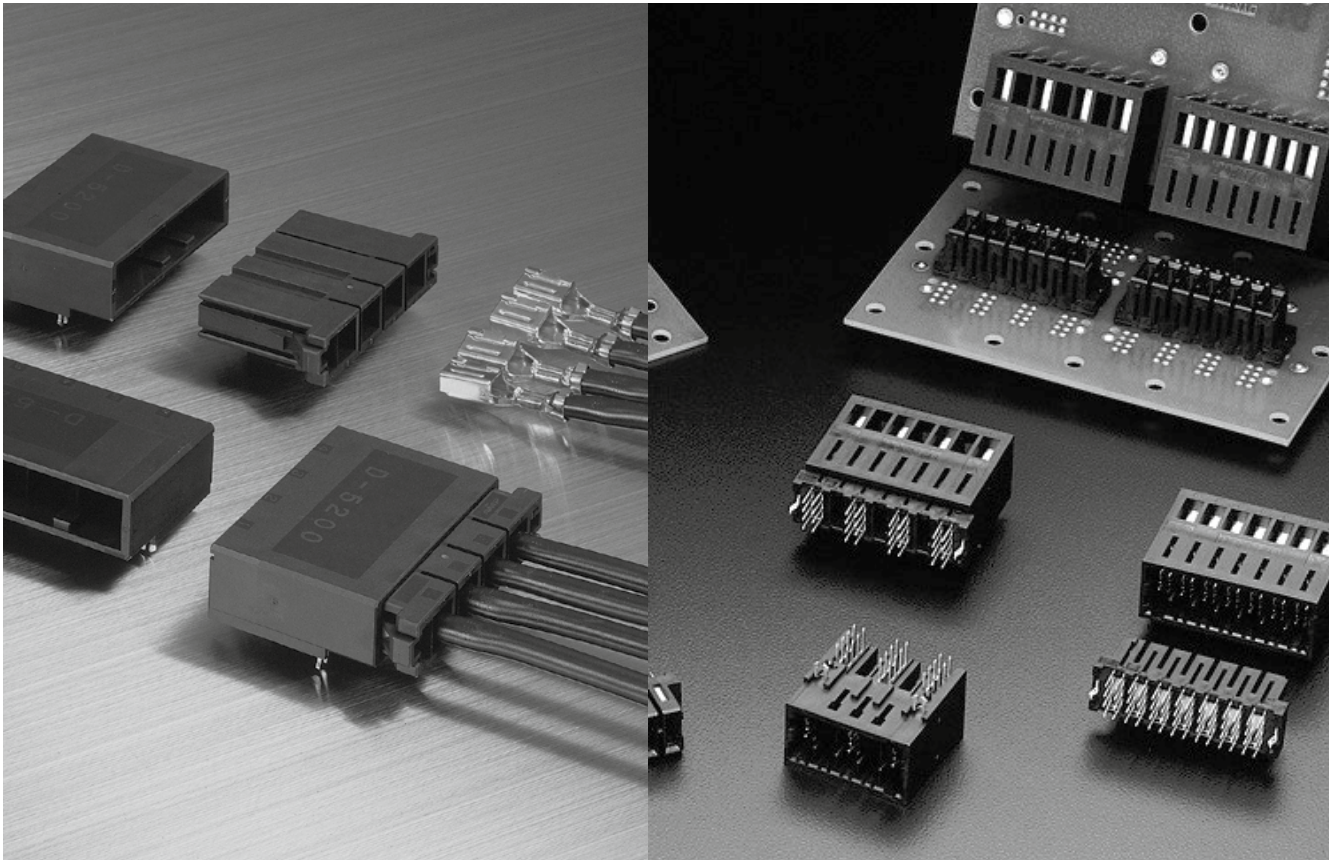

Series introduction

The Dynamic 5000 series was developed for up to 45 amperes in response to the demand for improved reliability and productivity for the main power lines in equipment.

They can be used for a variety of applications as replacements for terminal blocks, or round terminals. It is compact but with a high current capacity.

In addition, it has a wide variety of housings to cover all applications from PCB connections to internal wiring distribution.

The D-5000 series can be used for high current power line applications where reliability really matters.

Product Features

1. High Current Contact

The D-5000 series uses the same 'twis- resistant, box shape contact' as the rest of the Dynamic series contacts. The material is the same copper alloy developed for the D-3000 series with its superior elasticity and conductivity, which results in a reliable, robust contact capable of high current. Silver plated versions of the D-5000α series, which support higher currents, are also available. The terminals can be selected according to use.

2. Sequential Connection

The Sequential Mating means that the build up of static charge in the sequential contact is grounded first at mating. The long tab was developed for sequential connection of tab contacts. By using both this long tab contact and standard tab contacts, sequential connectivity is enhanced.

3. Contact for High Amperage

The contact for on-board mounting are a newly developed twin-lead type. It is possible to reliably join patterns and connectors because a wide area of PCBs can be allocated. New V shape contacts were developed for mounting on boards. Even though a lot of on-board connection space is needed, through-holes were made as small as possible to make pattern design easily (patent pending).

4. IP20 (Protection from the approach of the finger)

D-5300 is recommended for applications with a supply side in the IP20 apparatus. By using a housing on the apparatus side (panel side) which can accommodate the receptacle contact, the apparatus side connector meets IP20 requirement..

D-5000 Series Performance and Specifications

Performance

Item	D-5200	D-5300	D-5200α
Pitch	10.16mm		
Rated Voltage	630V AC / DC		
Withstanding Voltage	3000 VAC		
Total resistance	2mΩ max		
Insertion strength:	9.8N max (per position)		
Withdrawal strength	1.96N min (per position)		
Durability	50 cycles (0.76 μm Gold)		
Locking strength	98N min		

Product Specifications

Product Specifications		108-5453
Test Report		501-5188
Applications Specifications		114-5206
Hand tool manual	Part number: 234170-1	411-5712
	Part number: 234171-1	411-5713
	Part number: 91596-1	408-8547-1
	Part number: 1366044-1	411-5976
Unplugging tool (model: 409158-1) operation manual		411-5774

When applicable, please be sure to order the operating manuals. It can also be found in the online electronic specifications catalog.

Material and Plating

Category	Item	D-5200	D-5300	D-5200α
Receptacle Contacts Tab Contact	Materials	Copper alloys		
	Plating	Gold Plating with Nickel under-plated	Gold/Silver Plating with Nickel under-plated	Gold Plating with Nickel under-plated
Board Mount Header	Materials	Copper alloys	—	Copper alloy
	Plating	Gold Plating with Nickel under-plated	—	Gold Plating with Nickel under-plated
Housing	Materials	UL94V-0, glass fiber reinforced thermoplastic PBT		

Safety Standards

The safety specifications listed below are approved on specific part numbers. Please contact our Technical Support Centre to check whether the part numbers you use are approved or not. Keep in mind that there are instances where values differ from those given by Tyco Electronics Specifications

Series STD.	D-5200Series(10.16mmPitch)			D-5200Mα Series																																							
	Rated Voltage	Rated Current	Temperature Range	Rated Voltage	Rated Current	Temperature Range																																					
Product Specifications 108-5453	630V AC/DC	(As shown above)	-55°C~+105°C	630V AC/DC	(As shown above)	-55°C~+105°C																																					
UL File No.E28476 (Recognized Component)	Based on the requirements of application	Based on the requirements of application	—	—	Based on the requirements of application	—																																					
CSA Report No. LR 7189	600V AC/DC	<table border="1"> <tr><td>AWG</td><td>A</td></tr> <tr><td>16</td><td>13</td></tr> <tr><td>14</td><td>18</td></tr> <tr><td>12</td><td>25</td></tr> <tr><td>10</td><td>30</td></tr> </table>	AWG	A	16	13	14	18	12	25	10	30	—	—	—	—																											
AWG	A																																										
16	13																																										
14	18																																										
12	25																																										
10	30																																										
TÜV License No. R9650368 IP protection level IP-10 Overvoltage type (II) 50 cycles of repeated plugging and unplugging	600V AC/DC	<table border="1"> <tr><td>AWG</td><td>A</td></tr> <tr><td>16</td><td>15</td></tr> <tr><td>14</td><td>20</td></tr> <tr><td>12</td><td>25</td></tr> <tr><td>10</td><td>30</td></tr> </table>	AWG	A	16	15	14	20	12	25	10	30	-30°C~+105°C	—	<table border="1"> <tr><td>AWG</td><td colspan="2">A</td></tr> <tr><td></td><td>1-13P</td><td>4-No of Pos.</td></tr> <tr><td>20</td><td>12.5</td><td>12.5</td></tr> <tr><td>18</td><td>17.5</td><td>16</td></tr> <tr><td>16</td><td>21</td><td>19.5</td></tr> <tr><td>14</td><td>26</td><td>24</td></tr> <tr><td>12</td><td>33</td><td>31</td></tr> <tr><td>10</td><td>40</td><td>37.5</td></tr> <tr><td>8</td><td>48</td><td>46</td></tr> </table>	AWG	A			1-13P	4-No of Pos.	20	12.5	12.5	18	17.5	16	16	21	19.5	14	26	24	12	33	31	10	40	37.5	8	48	46	-30°C~+105°C
AWG	A																																										
16	15																																										
14	20																																										
12	25																																										
10	30																																										
AWG	A																																										
	1-13P	4-No of Pos.																																									
20	12.5	12.5																																									
18	17.5	16																																									
16	21	19.5																																									
14	26	24																																									
12	33	31																																									
10	40	37.5																																									
8	48	46																																									

Positions / Wire size / Rated current

ambient temperature: 25°C, temperature rise: 80°C

Series (Gold Plating)	Pos	Rated Current (A)						
		AWG 8	AWG 10	AWG 12	AWG 14	AWG 16	AWG 18	AWG 20
D-5200	2	60	48	40	32	25	22	17
	3	58	48	38	30	25	19	15
	4	53	48	36	28	24	19	15
	6	50	41	35	27	22	17	14
D-5300	3	51	43	38	30	24	17	14
	4	49	43	36	30	24	18	14
D-5200α	3	-	-	-	-	-	-	-
	4	51	46	41	34	29	23	21

Series (Silver Plating)	Type	Pos	Rated Current (A)						
			AWG 8	AWG 10	AWG 12	AWG 14	AWG 16	AWG 18	AWG 20
D-5200	wire to board	4	63	56	43	34	29	23	18
		2	74	57	48	39	32	26	20
	wire to wire	3	69	56	46	36	32	22	18
		4	67	55	44	37	27	23	18
		6	57	46	35	31	26	19	16
		3	59	47	41	30	24	19	15
D-5300	wire to wire	4	56	47	36	30	25	19	15
		3	-	-	-	-	-	-	-
D-5200α	wire to board	3	-	-	-	-	-	-	-
		4	63	50	41	34	28	22	19

D-5200 2pos, silver plating, wire to wire.

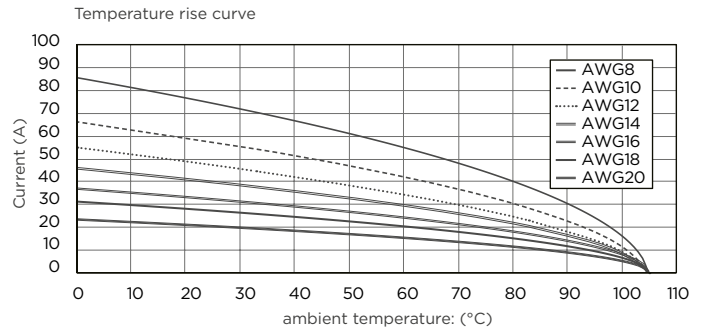

D-5000 Series Configurations

D-5200S

Single-row High Voltage Type

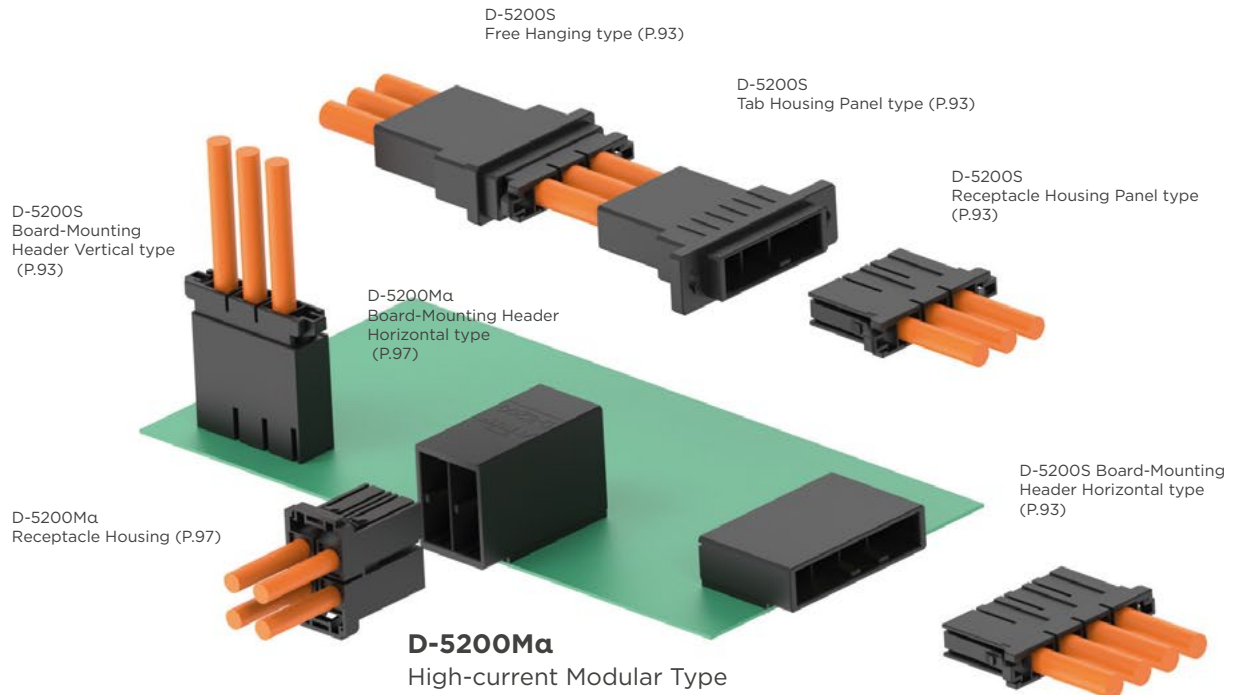

D-5200M

High-voltage Modular Type

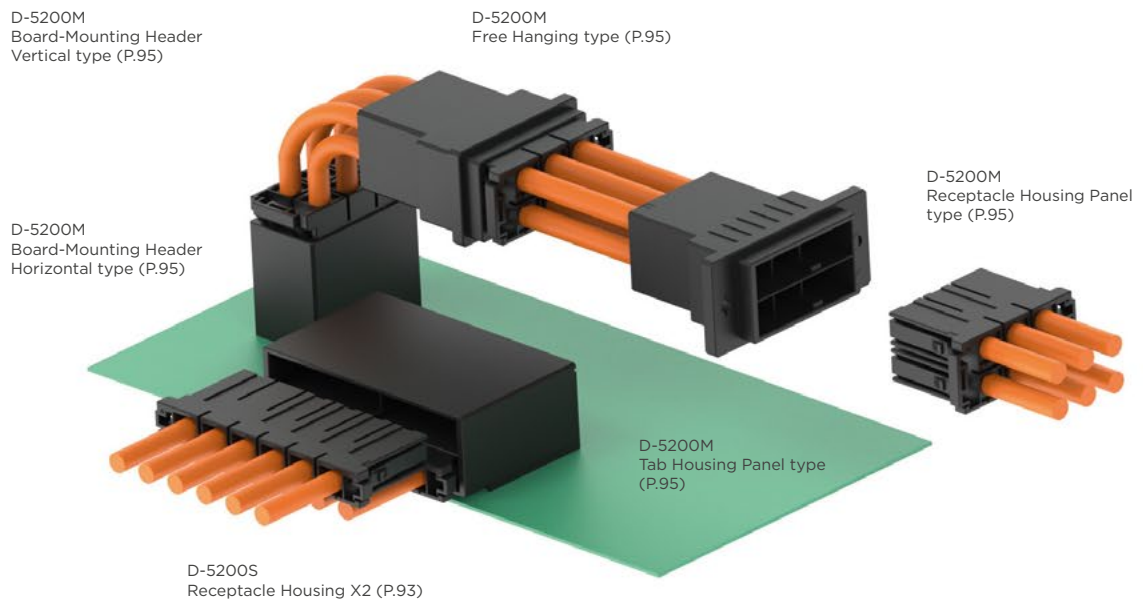

D-5000 Series Contact

Crimped Types



Receptacle Contact
(Used in Receptacle housing)

Tab contact
(Used in Tab housing)

Applicable Wire Range		Outside Diameter of Insulation mm	Wire Range Mark	Contacts						Applicable tools			
AWG	mm ²			Receptacle Contact		Tab Contact		Long sequential contacts		Manual Hand Tools	Electric Hydraulic Tool*1	Mold*2	Mini- Application Tool
		Strip form	Loose Piece	Strip form	Loose Piece	Strip form	Loose Piece						
20	0.50	1.8-2.83	SS	1318985-Δ	1318986-Δ	—	—	—	—	91596-1	—	—	*1
16	1.25	2.35-3.23											
16	1.25	3-3.80	S	179955-Δ	316040-Δ	917802-Δ	917804-Δ	84696-1	2013594-1	234170-1	2155369-1	2155822-1	2266273-2
14	2.20												
12	3.50	4-5.2	M	179956-Δ	316041-Δ	917803-Δ	917805-Δ	84695-1	2013593-1	234171-1			2155503-1
10	5.50												
8	8.00	4.9-7.8	L	1318696-Δ	1318697-Δ	1981690-Δ 1747388-6	1981691-Δ	2174021-1	2174022-1	1366044-1		2155502-1	2266274-2

Note Plating code
 -2: Gold plating of 0.38 μm in thickness
 -6: Silver plating of 2.54 μm in thickness
 -3: Gold plating of 0.76 μm in thickness
 -1: Gold plating of 0.2 μm in thickness

Please contact the sales department for mini applications tools.
 Strip Form contacts are used with Mini-applicators (bench machine) and Loose-Piece contacts are with hand tools.

*1 See P.123.
 If you have any questions, please contact the AT tooling sales department.

Please contact our sales department or distributor for more information.

*2 Used together with the electric hydraulic tool 2155369-1



D-5a Series silver-plated type

Wire Range		Outside Diameter of Insulation mm	Wire Range Mark	Contacts			Applicable tools			
AWG	mm ²			Receptacle Contact	Tab Contact		Hand Tools	Electric Hydraulic Tool*5	Dice*6	Tool numbers
		Strip form	Loose Piece	Loose Piece						
20	0.50	1.8-2.83	SS	1318985-6	1318986-6	—	91596-1	—	—	1366757-2 1528106-2
16	1.25	2.35-3.23								
16	1.25	3-3.80	S	179955-6	316040-6	917804-6	234170-1	2155369-1	2155822-1	1366659-2 1426229-2*1
14	2.20									
12	3.50	4-5.2	M	179956-6	316041-6	917805-6	234171-1			2155503-1
10	5.50									
8	8.00	4.9-7.8	L	1318696-6	1318697-6	1747443-6	1366044-1		2155502-1	1366658-3 1426325-2*4

Note: The model with its name including "-6" has a silver plating of 2.54 μm in thickness.

Please contact the sales department for mini application tools.
 Strip Form contacts are used with Mini-applicators (bench machine) and Loose-Piece contacts are with hand tools.

For details, please contact the purchase agent or sales department.

*1 Applicable contact:179955-Δ
 *2 Applicable contact:179956-Δ 917803-Δ 84695-Δ
 *3 Applicable contact:179956-Δ 917803-Δ
 *4 Applicable contact:1318696-Δ
 *5 See P.121
 If you have any questions, please contact the AT tooling sales department.

*6 Used together with the electric hydraulic tool 2155369-1

The receptacle contact can be used in all receptacle housings, the tab contact can be used in all tab housings.

NOTE: All products are RoHS compliant On selection.

D-5200S Single-Row High Current Type - 10.16mm pin pitch

Type Chart

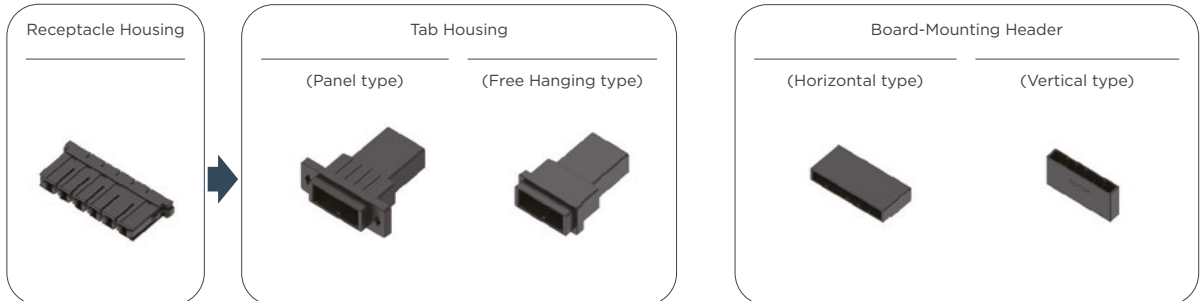

Pos	Color	Key	Receptacle housing	Tab housing		Plating	Board-Mounting Header					
				Panel type	Free Hangingtype		Horizontal type		Vertical type			
							Standard	Sequential	Standard	Sequential		
2	Black	X	1-179958-2	1-353047-2	1-353046-2	Gold	1-353079-2	—	1-353080-2	—		
	Black					1-353079-3	1-353080-3					
	Black					—	6-353080-2					
	Black	Y	2-179958-2	2-353047-2	2-353046-2	Gold	—	2-353080-2	—			
	Black					—	2-353080-3					
	Black					—	—					
3	Black	X	1-179958-3	1-353047-3	1-353046-3	Gold	1-353081-2	8-353081-2	1-353082-2	8-353082-2		
	Black					1-353081-3	—	1-353082-3	—			
	Black					—	—	—				
	Black	Y	2-179958-3	2-353047-3	2-353046-3	Gold	2-353081-2	—		2-353082-2	—	
	Black					2-353081-3	—	2-353082-3				
	Black					—	—	—				
4	Black	X	1-179958-4	4P or 6P Wire-to-wire connectors are available in D5200M, see P.93		Gold	1-917541-2	8-917541-2	1-917542-2	8-917542-2		
	Black					1-917541-3	—	1-917542-3	—			
	Black					2-917541-2	—	2-917542-2				
	Black	Y	2-179958-4				Gold	—		—	2-917542-3	—
	Black	—					—	1-179959-2	—			
	Black	—					—	1-179959-3				
6	Black	X	1-179958-6			Gold	1-179959-2	—		1-179960-2	—	
	Black					1-179959-3	—	1-179960-3				
	Black					—	—	6-179960-2				
	Black	Y	2-179958-6					Gold	2-179959-2	—	2-179960-2	—
	Black							2-179959-3	—	2-179960-3		
	Black							—	—	7-179960-2		

Relative Product Information

Applicable contact...P.92

Performance & Specifications...P.90

Mated Dimension

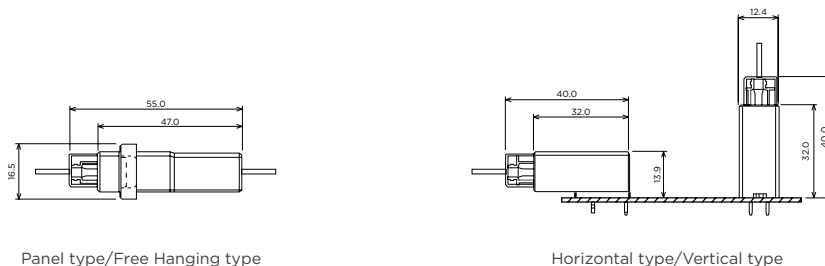

NOTE: All products are RoHS compliant On selection.

D-5200S Single-Row High Current Type – 10.16mm pin pitch

External Dimensions

- Receptacle Housing

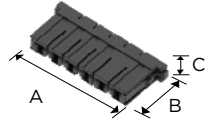

Pos	Key	Color	Part Number	Dimensions		
				A	B	C
2	X	Black	1-179958-2	35.8	29.0	9.8
	Y	Black	2-179958-2			
3	X	Black	1-179958-3	46.0		
	Y	Black	2-179958-3			
4	X	Black	1-179958-4	53.7		
	Y	Black	2-179958-4			
6	X	Black	1-179958-6	74.0		
	Y	Black	2-179958-6			

- Tab Housing

Panel type

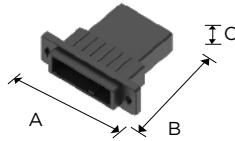

Pos	Key	Color	Part Number	Dimensions		
				A	B	C
2	X	Black	1-353047-2	47.0	47.0	16.5
	Y	Black	2-353047-2			
3	X	Black	1-353047-3	57.0		
	Y	Black	2-353047-3			

Panel type

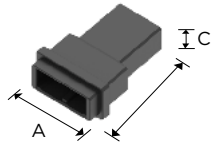

Pos	Key	Color	Part Number	Dimensions		
				A	B	C
2	X	Black	1-353047-2	47.0	47.0	16.5
	Y	Black	2-353047-2			
3	X	Black	1-353047-3	57.0		
	Y	Black	2-353047-3			

- Board-Mounting Header

Horizontal type

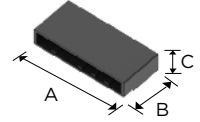

Pos	Key	Plating	Color	Part Number	Dimensions		
					A	B	C
2	X	Gold	Black	1-353079-2	29.4	32.0	13.9
		Gold	Black	1-353079-3			
3	X	Gold	Black	1-353081-2	39.5		
		Gold	Black	8-353081-2*			
		Gold	Black	1-353081-3			
		Gold	Black	2-353081-2			
4	Y	Gold	Black	2-353081-3	49.7		
		Gold	Black	1-917541-2			
		Gold	Black	8-917541-2*			
		Gold	Black	1-917541-3			
6	X	Gold	Black	2-917541-2	70.0		
		Gold	Black	1-179959-2			
		Gold	Black	1-179959-3			
		Gold	Black	2-179959-3			
6	Y	Gold	Black	1-179959-2	70.0		
		Gold	Black	2-179959-3			

* 1 Sequential

Vertical type

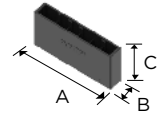

Pos	Key	Plating	Color	Part Number	Dimensions		
					A	B	C
2	X	Gold	Black	1-353080-2	29.4	32.0	12.4
		Gold	Black	1-353080-3			
		Gold	Black	6-353080-2			
		Gold	Black	2-353080-2			
3	Y	Gold	Black	2-353080-3	39.5		
		Gold	Black	1-353082-2			
		Gold	Black	8-353082-2*			
		Gold	Black	1-353082-3			
4	X	Gold	Black	2-353082-2	49.7		
		Gold	Black	1-353082-3			
		Gold	Black	8-917542-2*			
		Gold	Black	1-917542-3			
6	Y	Gold	Black	2-917542-2	70.0		
		Gold	Black	2-917542-3			
		Gold	Black	1-179960-2			
		Gold	Black	1-179960-3			
6	X	Gold	Black	6-179960-2	70.0		
		Gold	Black	2-179960-2			
		Gold	Black	1-179960-3			
		Gold	Black	7-179960-2			
6	Y	Gold	Black	2-179960-3	70.0		
		Gold	Black	1-179960-2			

* 1 Sequential

NOTE: All products are RoHS compliant On selection.

D-5200M Double-row High Current Modular Type - 10.16mm pin pitch

Type Chart

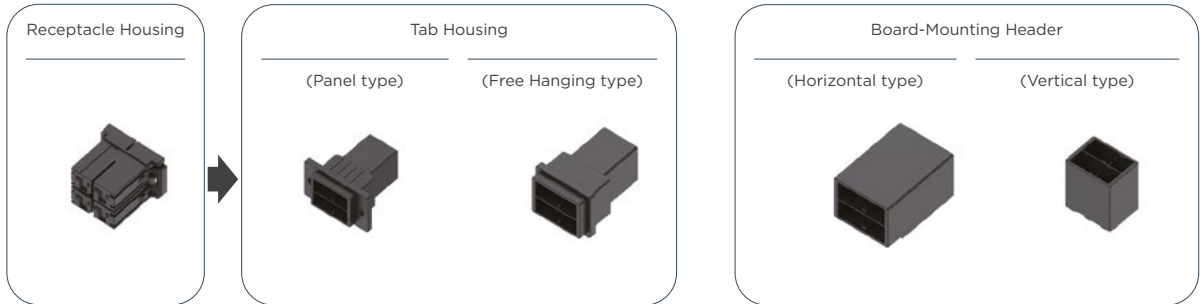

Pos	Color	Key	Receptacle housing	Tab housing		Plating	Board-Mounting Header					
				Panel type	Free Hangingtype		Horizontal type		Vertical type			
							Standard	Sequential	Standard	Sequential		
4	Black	XX	1-917807-2	1-917809-2	1-917808-2	Gold/Silver	1-1123309-2	8-1123309-2	1-1981458-6			
	Black	XX	2-917807-2	2-917809-2	2-917808-2	Gold/Silver	2-1123309-2				2-1981458-6	
	Black	XX	3-917807-2	3-917809-2	3-917808-2	Gold/Silver	3-1123309-2				3-1981458-6	
6	Black	XX	1-917807-3	1-917809-3	1-917808-3	-	-	-	1-2326092-2			
	Black	XX	2-917807-3	2-917809-3	2-917808-3				2-2326092-2		-	
	Black	XX	3-917807-3	3-917809-3	3-917808-3				3-2326092-2			
8	Black	XX	-*1	-	-	Gold	1123829-1	-				
	Black	XX	-			-	-			-		

* 1: Use two 1-179958-4

Relative Product Information

Applicable contact...P.92

Performance & Specifications...P.90

Mated Dimension

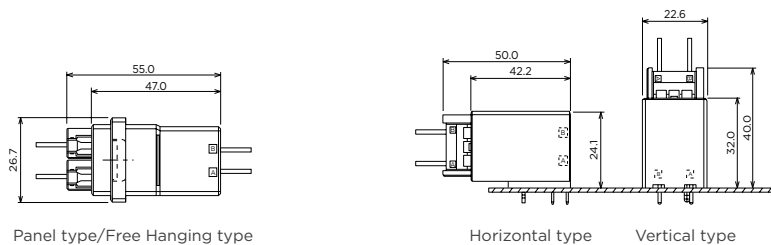

NOTE: All products are RoHS compliant On selection.

D-5200M Double-row High Current Modular Type – 10.16mm pin pitch

External Dimensions

- Receptacle Housing

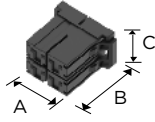

Pos	Key	Color	Part Number	Dimensions		
				A	B	C
4	XX	Black	1-917807-2	33.4	29.0	20.0
	YY		2-917807-2			
	XY		3-917807-2			
6	XX	Black	1-917807-3	43.5	29.0	20.0
	YY		2-917807-3			
	XY		3-917807-3			

- Tab Housing

Panel type

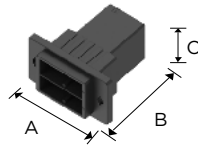

Pos	Key	Color	Part Number	Dimensions		
				A	B	C
4	XX	Black	1-917809-2	47.0	47.0	26.7
	YY		2-917809-2			
	XY		3-917809-2			
6	XX	Black	1-917809-3	57.0	47.0	26.7
	YY		2-917809-3			
	XY		3-917809-3			

Free Hanging type

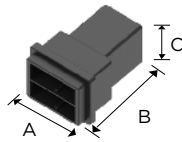

Pos	Key	Color	Part Number	Dimensions		
				A	B	C
4	XX	Black	1-917808-2	33.4	47.0	26.7
	YY		2-917808-2			
	XY		3-917808-2			
6	XX	Black	1-917808-3	43.6	47.0	26.7
	YY		2-917808-3			
	XY		3-917808-3			

- Board-Mounting Header

Horizontal type

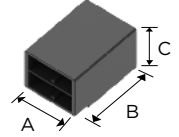

Pos	Key	Plating	Color	Part Number	Dimensions		
					A	B	C
4	XX	Gold	Black	1-1123309-2	29.4	42.2	24.1
	YY			2-1123309-2			
	XY			3-1123309-2			
8	XX			1123829-1	49.7	32.0	26.3

Sequential type

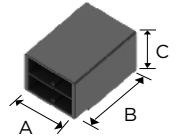

Pos	Key	Plating	Color	Part Number	Dimensions		
					A	B	C
4	XX	Gold	Black	8-1123309-2	29.4	42.2	24.1

Vertical type

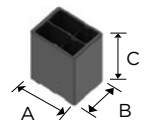

Pos	Key	Plating	Color	Part Number	Dimensions		
					A	B	C
4	XX	Silver	Black	1-1981458-6	29.4	22.6	32.0
	YY			2-1981458-6			
	XY			3-1981458-6			
6	XX	Gold	Black	1-2326092-2	39.5	22.6	32
	YY			2-2326092-2			
	XY			3-2326092-2			

NOTE: All products are RoHS compliant On selection.

D-5200Ma Double-row High Current/Voltage Modular Type - 10.16mm pin pitch

Type Chart



Pos	Color	Key	Receptacle housing	Tab housing		Plating	Board-Mounting Header	
				Panel type	Free Hanging type		Horizontal type	Vertical type
2	Black	X	1-179958-2	-	-	-	-	-
	Black	Y	2-179958-2					
4	Black	XX	1-917807-2					
	Black	YY	2-917807-2					
	Black	XY	3-917807-2					
						Silver	1-1318983-6	
						Silver	2-1318983-6	
						Silver	3-1318983-6	

Note: Receptacle housing 2-pole D-5200S and 4-pole D-5200M are the same product
However, contact used is D-5a (silver plating type)

Relative Product Information

Applicable contact...P.92

Performance & Specifications...P.90

Mated Dimension

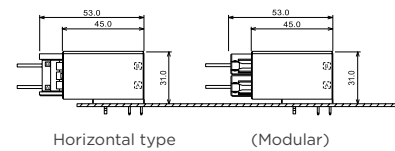

External Dimensions

- Receptacle Housing

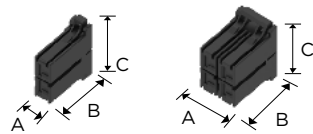

Pos	Key	Plating	Color	Part Number	Dimensions		
					A	B	C
2	X	-	Black	1-179958-2	9.8	29.0	23.8
	Y	-	Black	2-179958-2			
4	XX	-	Black	1-917807-2	20.0	29.0	33.4
	YY	-	Black	2-917807-2			
	XY	-	Black	3-917807-2			

- Board-Mounting Header

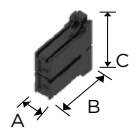

Pos	Key	Color	Part Number	Dimensions		
				A	B	C
3	X	Black	1-1747819-3	46.5	47.0	12.5
	Y	Black	2-1747819-3			
4	XX	Black	1-1747820-2	33.8	47.0	22.6
	YY	Black	2-1747820-2			
	XY	Black	3-1747820-2			

D-5300 Reversed Mounting Type - 10.16mm pin pitch

Type Chart

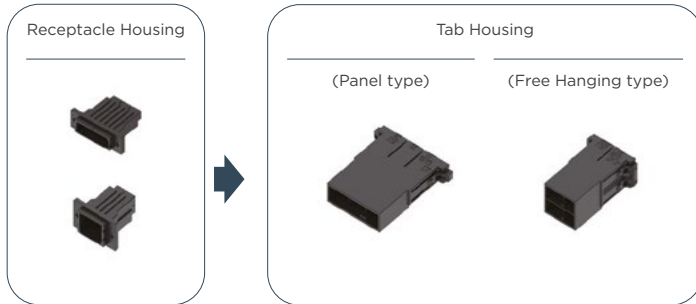

Pos	Color	Key	Receptacle housing	Tab housing		Plating	Board-Mounting Header			
				Panel type	Free Hangingtype		Horizontal type		Vertical type	
							Standard	Sequential	Standard	Sequential
4	Black	XX	1-917807-2	1-917809-2	1-917808-2	Gold/Silver	1-1123309-2	8-1123309-2	1-1981458-6	-
	Black	XX	2-917807-2	2-917809-2	2-917808-2	Gold/Silver	2-1123309-2	-	2-1981458-6	
	Black	XX	3-917807-2	3-917809-2	3-917808-2	Gold/Silver	3-1123309-2	-	3-1981458-6	
6	Black	XX	1-917807-3	1-917809-3	1-917808-3	-	-	-	1-2326092-2	-
	Black	XX	2-917807-3	2-917809-3	2-917808-3				2-2326092-2	
	Black	XX	3-917807-3	3-917809-3	3-917808-3				3-2326092-2	
8	Black	XX	-*1	-	-	Gold	1123829-1	-	-	
	Black	XX	-			-	-			

* 1: Use two 1-179958-4

Relative Product Information

Applicable contact...P.92

Performance & Specifications...P.90

Mated Dimension

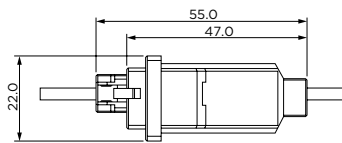

D-5300S

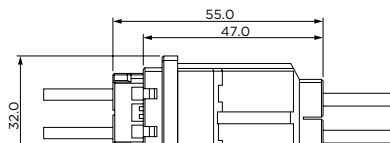

D-5300D

External Dimensions

• Receptacle Housing

Panel type

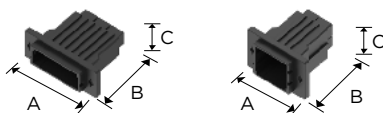

Pos	Key	Color	Part Number	Dimensions		
				A	B	C
3	X	Black	1-1747821-3	57.0	47.0	22.0
	Y	Black	2-1747821-3			
4	XX	Black	1-1747822-2	47.0	47.0	32.0
	YY	Black	2-1747822-2			
	XY	Black	3-1747822-2			

• Tab Housing

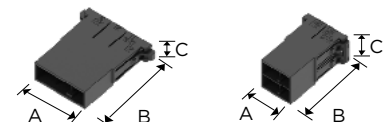

Pos	Key	Color	Part Number	Dimensions		
				A	B	C
3	X	Black	1-1747819-3	46.5	47.0	12.5
	Y	Black	2-1747819-3			
4	XX	Black	1-1747820-2	33.8	47.0	22.6
	YY	Black	2-1747820-2			
	XY	Black	3-1747820-2			

NOTE: All products are RoHS compliant On selection.

D-5200 Dyna-Tap 12P(4Px3 Row), 20P(4Px5 Row) – 10.16mm pin pitch

Type Chart

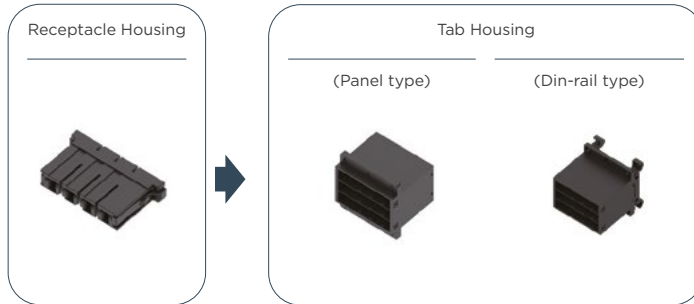

Pos	Color	Key	Receptacle housing	Tab housing		Plating	Board-Mounting Header	
				Panel type	Din-rail type		Horizontal type	Vertical type
4	Black	—	1-179958-4	—	—	Gold	—	—
12	Black	—	—	1903146-1*1	1903146-3			
12	Black	—	—	1903146-2*2	1-1903146-3			
20	Black	—	—	2013285-1*1	—			
	Black	—	—	2013285-2*2	2013285-3			

* 1:Front panel type * 2:Bottom panel type

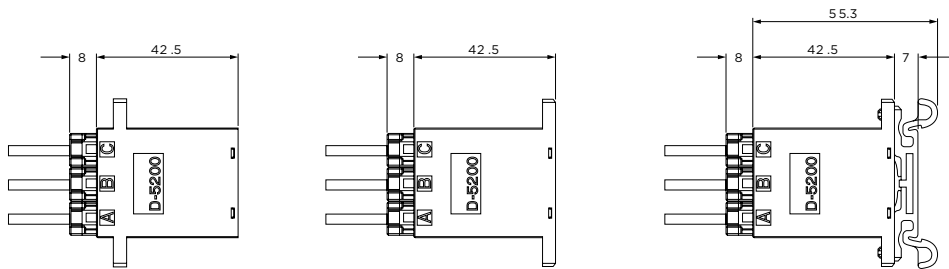

External Dimensions

- Receptacle Housing

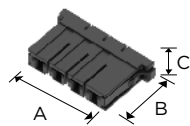

Pos	Key	Color	Part Number	Dimensions		
				A	B	C
3	X	Black	1-1747821-3	57.0	47.0	22.0
	Y	Black	2-1747821-3			
4	XX	Black	1-1747822-2	47.0		32.0
	YY	Black	2-1747822-2			
	XY	Black	3-1747822-2			

- Tab Housing

Panel type

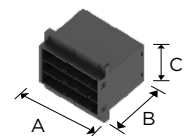
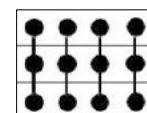

Pos	Key	Color	Part Number	Dimensions		
				A	B	C
3	X	Black	1-1747819-3	46.5	47.0	12.5
	Y	Black	2-1747819-3			
4	XX	Black	1-1747820-2	33.8		22.6
	YY	Black	2-1747820-2			
	XY	Black	3-1747820-2			

Panel type

Pos	Key	Plating	Color	Part Number	Dimensions		
					A	B	C
12	—	Gold	Black	1903146-3	49.7	55.3	50.0
	—	Gold	Black	1-1903146-3			
20	—	Gold	Black	2013285-3	53.0		76.4

NOTE: All products are RoHS compliant On selection.

Dyna-Clamp Kit/ Cable Clamp Kit – 10.16mm pin pitch

Type Chart

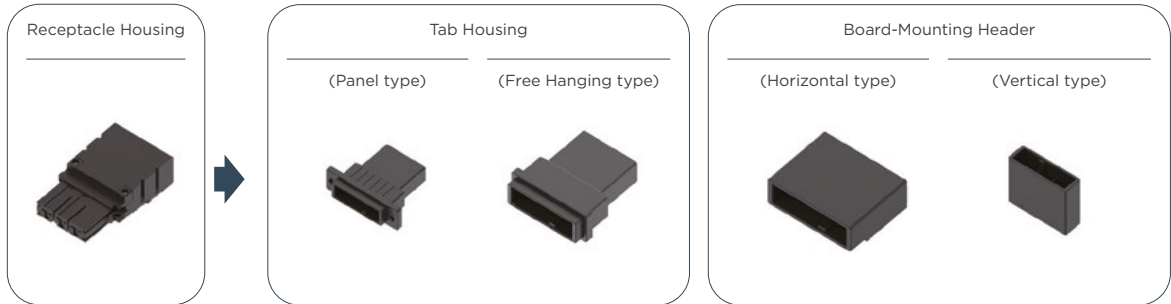

Pos	Key	Receptacle housing	Tab housing		Board-Mounting Header	
			Panel type	Free Hanging type	Horizontal type	Vertical type
3	—	1473668-1	1-353047-3	1-353046-3	1-353081-2	1-353082-2
					1-353081-3	1-353082-3
4	XX	1971239-1	1-917809-2	1-917808-2	1-1123309-2	1-1981458-6*
	YY	1971239-2	2-917809-2	2-917808-2	2-1123309-2	2-1981458-6*

* Silver-plated products

Mated Dimension

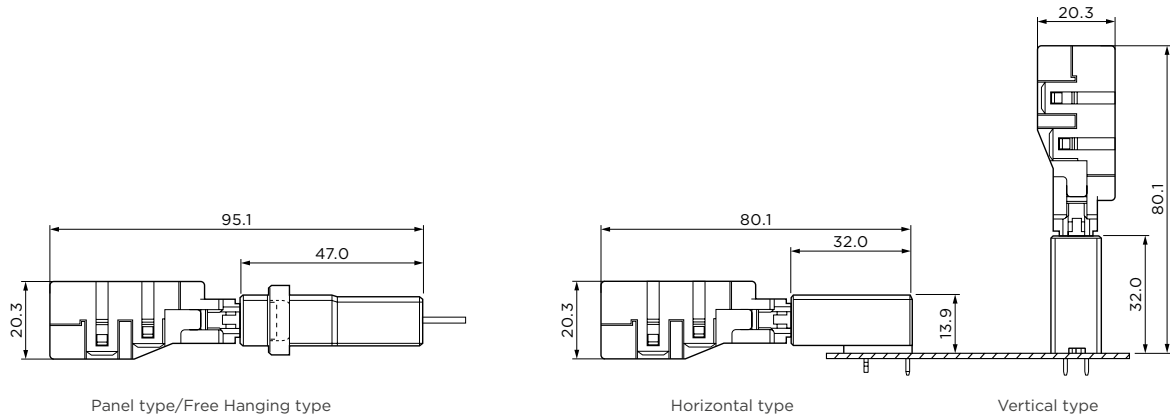

External Dimensions

- Receptacle Housing

Single-row

Double-row

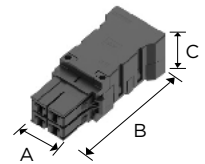
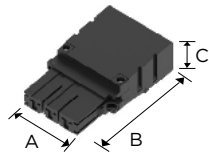

Pos	Key	Color	Part Number	Dimensions		
				A	B	C
3	—	Black	1473668-1	40.3	69.3	20.3

Pos	Key	Color	Part Number	Dimensions		
				A	B	C
4	XX	Black	1971239-1	36.0	81.2	29.0
	YY		1971239-2			

NOTE: All products are RoHS compliant On selection.

Dyna-Clamp Kit /Cable Clamp Kit – 10.16mm pin pitch

- Tab Housing

Panel type

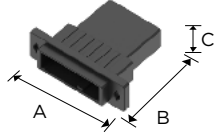

Pos	Key	Color	Part Number	Dimensions		
				A	B	C
3	X	Black	1-353047-3	57.0	47.0	12.1
4	XX	Black	1-917809-2	47.0		26.7
	YY	Black	2-917809-2			

Free Hanging type

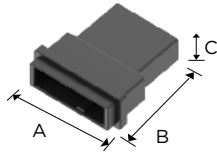

Pos	Key	Color	Part Number	Dimensions		
				A	B	C
3	X	Black	1-353046-3	43.6	47.0	12.1
4	XX	Black	1-917808-2	33.4	47.0	26.7
	YY	Black	2-917808-2			

- Board-Mounting Header

Horizontal type

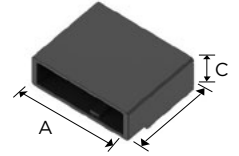

Pos	Key	Plating	Color	Part Number	Dimensions		
					A	B	C
3	X	Gold	Black	1-353081-2	39.5	32.0	13.9
		Gold	Black	1-353081-3			
4	XX	Gold	Black	1-1123309-2	29.4	42.2	24.1
	YY	Gold	Black	2-1123309-2			

Vertical type

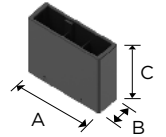

Pos	Key	Plating	Color	Part Number	Dimensions		
					A	B	C
3	X	Gold	Black	1-353082-2	39.5	12.4	32.0
			Black	1-353082-3			
4	XX	Silver	Black	1-1981458-6	29.4	22.6	
	YY		Black	2-1981458-6			

NOTE: All products are RoHS compliant On selection.

DZ-5200

- Useful for enabling cableless control board. High-current board to board connectors with 30A per contact.
- Equipped with retention leg to protect board from load
- Space allocated to prevent the contact from twisting
- Stacking and parallel connection types available
- Circuit numbers are easily identified for board connectors
- Keying function included for flexibility when using multiple units
- Soldering without masking
- Passes UL, CSA and TUV standards

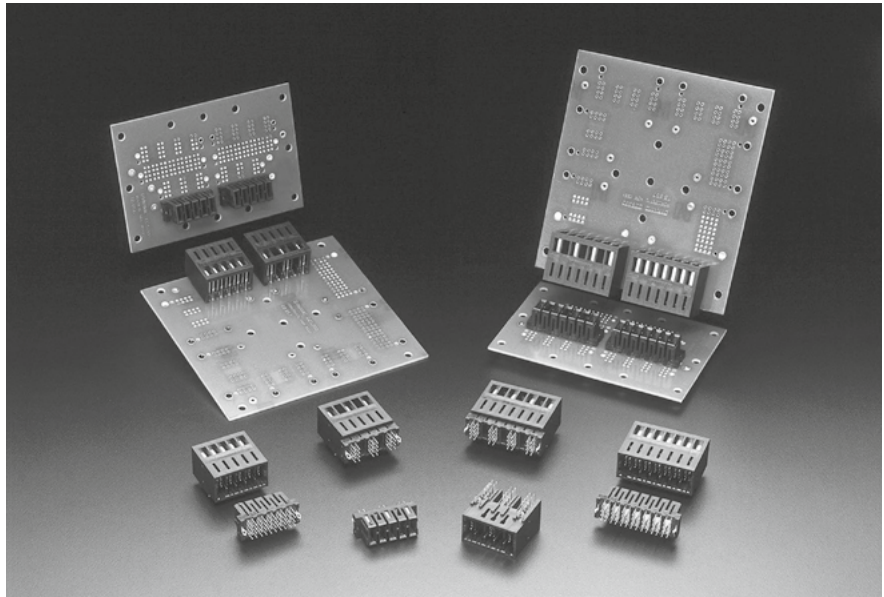

Performance Specifications

Item	Pitch	200 mils/400 mils 5.08mm/10.16mm
Rated Voltage		5.08mm Pitch:250V AC(rms)/DC 10.16mm Pitch:600V AC(rms)/DC
Rated Current		5.08mm Pitch:20A 10.16mm Pitch:30A
Contact resistance		2mΩ max
Withstanding Voltage		5.08mm Pitch:2,200V AC 1 min 10.16mm Pitch:4,000V AC 1 min
Temperature		-55-+105°C
Product Specifications		108-78186

Materials and Plating

Category	Materials	Plating
Receptacle Contact Tab Contact	Phosphor bronze Copper alloys	Gold Plating with Nickel under-plated
Tab	Phosphor bronze Copper alloys	Tin, Gold Plating with Nickel under-plated
Housing	UL9 4V-0, thermoplastic PBT with glass fiber	

DZ-5200 – 5.08mm pitch for 5/7 position pins, 10.16mm pitch for 3/4 position pins

Type Chart

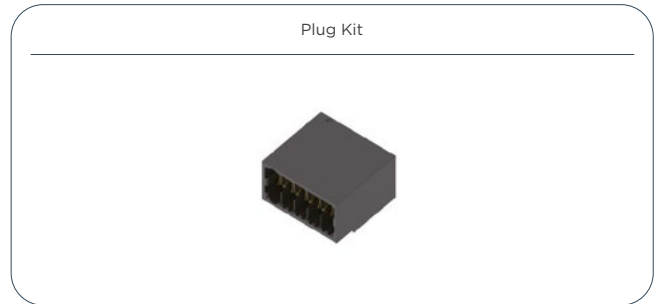
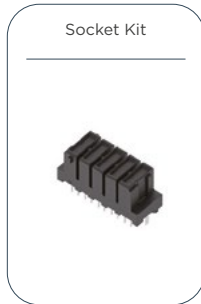

Pos	Color	Key	Socket Kit	Plating	—	Plug Kit
3	Black	—	5-1747147-3	Gold	—	5-1747145-3
4	Black	—	5-1747147-4	Gold	—	5-1747145-4
5	Black	—	1-1747147-5	Gold	—	1-1747145-5
7	Black	—	1-1747147-7	Gold	—	1-1747145-7

External Dimensions

- Socket Kit

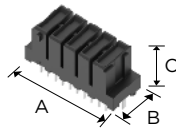

Pos	Key	Plating	Color	Part Number	Dimensions		
					A	B	C
3	—	Gold	Black	5-1747147-3	30.8	11.5	14.0
4	—	Gold	Black	5-1747147-4	40.9		
5	—	Gold	Black	1-1747147-5	30.8		
7	—	Gold	Black	1-1747147-7	40.9		

- Plug Kit

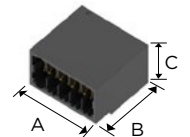

Pos	Key	Plating	Color	Part Number	Dimensions		
					A	B	C
3	—	Gold	Black	5-1747145-3	28.8	27.0	17.5
4	—	Gold	Black	5-1747145-4	39.0		
5	—	Gold	Black	1-1747145-5	28.8		
7	—	Gold	Black	1-1747145-7	39.0		

NOTE: All products are RoHS compliant On selection.

Multi-Frame connector (MF Series)

The Multi-Frame connector is formed by combining the modular housing of the Dynamic Series connector with a resin frame. The modular structure can accommodate housings for D-2800, 3800, 4800 or 5800.

Additionally, the secure locking mechanism can be easily locked and unlocked by pressing the latches. The simple design saves time in assembly and maintenance.

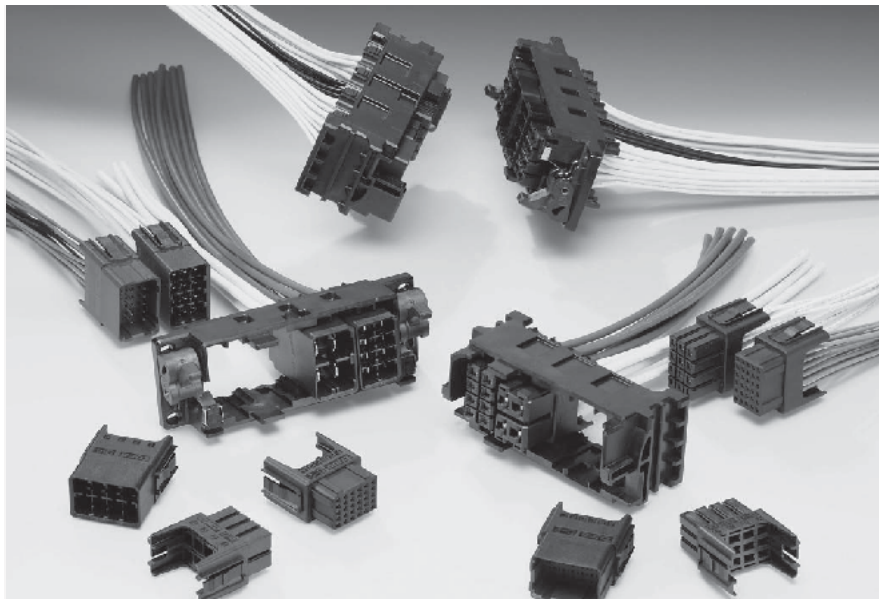

Main Performance

Item	Series	D-2800	D-3800	D-4800	D-5800
Rated Voltage		AC/DC 250V	AC/DC 600V	AC/DC 600V	AC/DC 630V
Rated Current		5A	15A	25A	40A
		When an AWG#18 wire is used	When an AWG#16 wire is used	When an AWG#12 wire is used	When an AWG#8 wire is used
Contact resistance		10mΩ max			2mΩ max
Withstanding Voltage		1,500VAC(1 min)		2,500VAC(1 min)	3,000VAC(1 min)
Operating Temperature		-55-+105°C			
Product Specifications		108-78284	108-78285	108-78388	108-78389
Applications Specifications		114-5258	114-5148	114-5369	114-5206

Materials and Plating

Category	Materials	Plating
Receptacle Contact Tab Contact	Phosphor bronze or copper alloy	Gold Plating with Nickel under-plated
Housing	UL94V-0, reinforced thermoplastic with glass fiber	

Contact
The D-2, D-3, D-4 and D-5 contacts of the Dynamic series can be directly used.
(The existing tools can also be used as special tools and application tools)
See P.36 for the D-2 terminal. See P.83 for the D-4 terminal.
See P.46 for the D-3 terminal. See P.90 for the D-5 terminal.

Multi-Frame Connector

Product Features

- The modular structure can accommodate Dynamic series housings
- Panel mount
- Quick locking
- Easy unlocking by pressing the latches
- A key for preventing mis-plugging
- Easy operation

Applications

- Semiconductor and liquid crystal production equipment
- Large control equipment and machine tools
- Other

Product Specifications

Product standard number 108-78644

Performance Specification

Item	STD.
Frame Lock Strength	Pull force: 15kgf min
Durability	50 cycles max

Mated Dimension

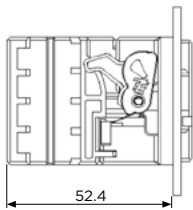

External Dimensions

- Cable Side Frame

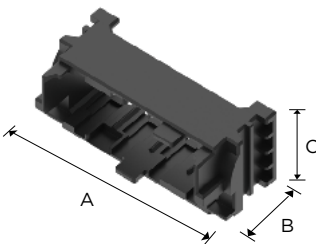

Module	Key	Part Number	Dimensions(mm)		
			A	B	C
2	W	2390402-1	56.8	45.1	40.4
4	Z	2069524-4	97.1	45.1	40.4
	Y	2069524-3			
	X	2069524-2			
	W	2069524-1			

- Panel Side Frame

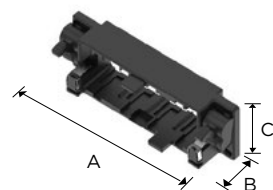

Module	Key	Part Number	Dimensions(mm)		
			A	B	C
2	W	2390404-1	79.8	34.3	40.4
4	Z	2069526-4	120.0	34.3	40.4
	Y	2069526-3			
	X	2069526-2			
	W	2069526-1			

Dynamic HTS Module – 12.0mm pin pitch

Type Chart

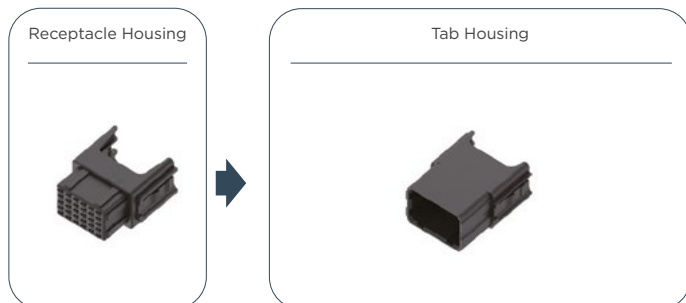

Pos	Color	Key	Receptacle housing	Tab housing	Plating	Board-Mounting Header	
						Horizontal type	Vertical type
30	Black	—	1747365-1	1747366-1	—	—	—
12	Black	—	1747363-1	1747364-1			
8	Black	—	1871416-1	1871417-1			
4	Black	—	1871418-1	1871419-1			

D-2800 Pitch: 3.75mm

External Dimensions

- Receptacle Housing

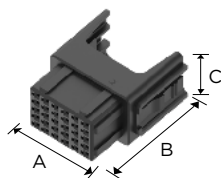

Pos	Key	Color	Part Number	Dimensions		
				A	B	C
30	—	Black	1747365-1	30.3	37.6	19.5

- Tab Housing

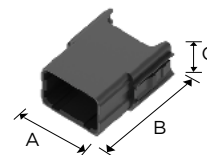

Pos	Key	Color	Part Number	Dimensions		
				A	B	C
30	—	Black	1747366-1	30.3	40.0	19.5

NOTE: All products are RoHS compliant On selection.

Dynamic Series Connector – 12.0mm pin pitch

D-3800 Pitch: 6.5mm

External Dimensions

- Receptacle Housing

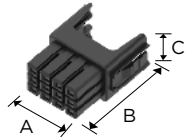

Pos	Key	Color	Part Number	Dimensions		
				A	B	C
12	—	Black	1747363-1	30.3	41.4	19.5

- Tab Housing

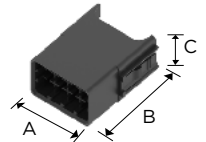

Pos	Key	Color	Part Number	Dimensions		
				A	B	C
12	—	Black	1747364-1	30.3	40.0	19.5

D-4800 Pitch: 6.35mm

External Dimensions

- Receptacle Housing

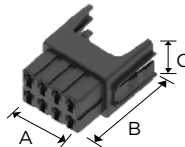

Pos	Key	Color	Part Number	Dimensions		
				A	B	C
8	—	Black	1871416-1	30.3	38.6	19.5

- Tab Housing

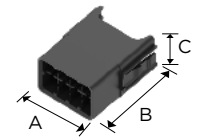

Pos	Key	Color	Part Number	Dimensions		
				A	B	C
8	—	Black	1871417-1	30.3	40.0	19.5

D-5800 Pitch: 12.0mm

External Dimensions

- Receptacle Housing

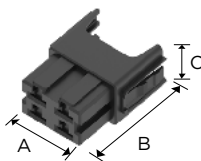

Pos	Key	Color	Part Number	Dimensions		
				A	B	C
4	—	Black	1871418-1	30.3	41.4	19.5

- Tab Housing

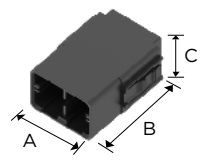

Pos	Key	Color	Part Number	Dimensions		
				A	B	C
4	—	Black	1871419-1	30.3	44.1	19.5

NOTE: All products are RoHS compliant On selection.

D-7000 Series

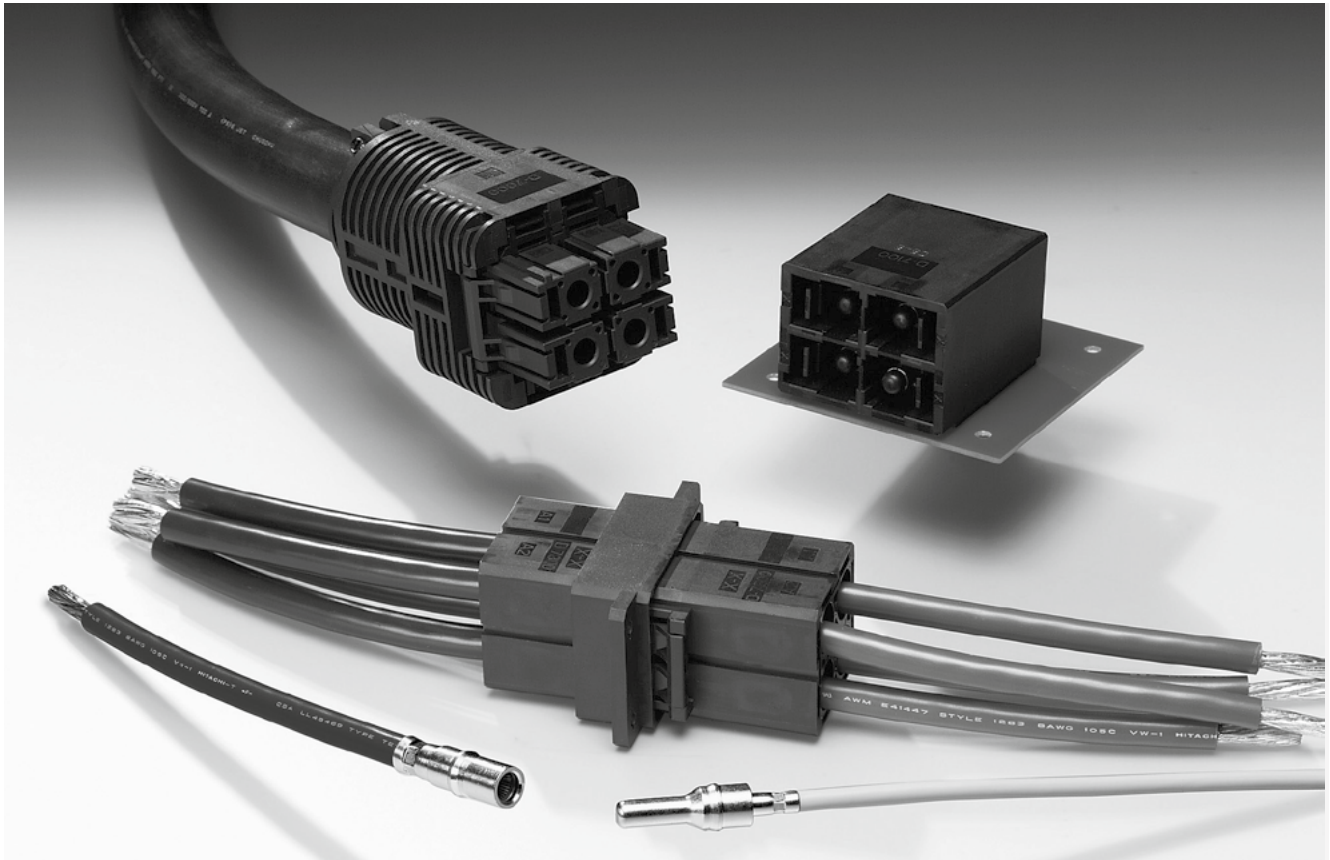

Series introduction

Dynamic D-7000 series includes the highest power rated connector that is max 65A (per contact, using max. wire size)

It is available in board to wire, wire to wire, wire to panel -some are finger safe (Reverse Mount Type) – and long pin types all providing stable electrical connections for semiconductor manufacturing machines, construction plant etc.

The number of positions is the industry standard 4P, which will meet a wide range of application requirements.

The receptacle contact is the 'crown band type containing a tube shape spring, meaning high performance and operation feasibility.

Product Features

1. Achieved High Current and High Reliability up to 65A

To accommodate the high current of 65A, we adopted, for the first time, a crown band with a multi-point contact mechanism in the receptacle contact. This contact is not only highly reliable, but disperses the heat generated when high current passes through the contact

2. Sequential Connection

Sequential connection is compatible 2 types of pin contact are available, standard type and long type. This is ideal for applications when sequential connections from the crown pin are required.

3. Other

- Standard type and reverse type are available, offering a wide variety of mating options
- By using cable clamp type applicable to jacket cable, it can be used as an I/O connector

D-7000 Series Performance and Specifications

Performance

Item	
Pitch	16mm
Rated Current	65A max
Rated Voltage	630V AC / DC
Dielectric Withstand Voltage	3000 VAC
Total resistance	2mΩ max
Insertion strength:	49.0N max (per positions)
Withdrawal strength	4.9N min (per positions)
Durability	20 cycles
Locking strength	196N min

Product Specifications

Product Specifications	108-78470
TEST REPORT	501-78004
Extraction tool application specification	408-78147
Applications Specifications	114-5452

When applicable, please be sure to order the operation manual. It can also be found in the online electronic specifications catalog.

Positions / Wire size / Rated current

Unit: A (Amps)

Position	Series	Wire Size(AWG)					
		14	12	10	8	6	
4	Wire-to-board	18	23	31	35	50	60
4	Wire-to-wire	—	—	31	35	55	65
4	Wire-to-wire(cable clamp type)	—	—	25	35	45	55

Materials and Plating

Type	Item	Tab contact	Receptacle Contact (Crown-shaped Terminal)
Contacts	Materials	Copper	Copper alloys
	Plating	Silver plating with Nickel under-plated	Gold plating with Nickel under-plated
Board Mount Header	Materials	Copper	—
	Plating	Silver plating with Nickel under-plated	—
Housing	Materials	UL94V-0, Thermoplastic PBT containing glass fiber	

Safety Standards

The safety specifications listed below are approved on specific part numbers. Please contact our Technical Support Centre to check whether the part numbers you use are approved or not. Keep in mind that there are instances where values differ from those given by Tyco Electronics Specifications.

SeriesSTD.	D-7100Series			D-7300Series							
	Rated Voltage	Rated Current	Temperature Range	Rated Voltage	Rated Current	Temperature Range					
Product Specifications 108-5453	630V AC/DC	(As shown above)	-55°C ~+105°C	630V AC/DC	(As shown above)	-55°C ~+105°C					
ULFile No.E28476 (Recognized Component)	600V AC	Based on the requirements of Application	Uses AWG6 wires Allowable maximum 6A	600V AC	Based on the requirements of Application	Based on the requirements of Application					
TÜVLicense No. R50252537IP protection Socket: IP-10 Plug: IP-000- vervoltage type (II) 50 cycles of repeated plugging andunplugging	630V AC/DC	4-No of Pos.		-55°C ~+105°C	630V AC/DC	4-No of Pos.					
		AWG	WTW			WIRE-TO BOARD	Dyna-clamp	AWG	WTW	WIRE-TO BOARD	Dyna-clamp
		16	18			—	—	16	18	—	—
		14	23			—	—	14	23	—	—
		12	31			31	25	12	31	31	25
		10	35			35	35	10	35	35	35
		8	50			55	45	8	50	55	45
6	60	65	55	6	60	65	55				

NOTE: All products are RoHS compliant On selection.

D-7000 Series Contact

Crimped Types



Receptacle Contact
(Receptacle housing usage)



Tab contact
(Tab housing usage)

Gold-plated Receptacle contact, Silver plated Tab contact

Wire Range		Outside Diameter of insulation mm	Diameter of Contacts		Applicable tools	
AWG	mm ²		Receptacle Contact	Tab contact		
16-14	1.6-2.6	10	1871132-4	—	409777-1*1	
12-10	2.7-6.6	10	1871132-3	STD.	1871131-3	2155816-1 *3
				LONG	1-1871131-3	2155815-1 *4
8	6.7-10.5	10	1871132-2	STD.	1871131-2	2155369-1 *2
				LONG	1-1871131-2	
6	10.6-16.7	10	1871132-1	STD.	1871131-1	2155810-1 *6
				LONG	1-1871131-1	

Note: For details, please contact the purchase agent or sales department.

*1 Hand tool (W-shaped crimp)

*2 Electric hydraulic tool See P.121.

If you have any questions, please contact the sales department.

*3 Mold (2155369-1 used together with the electric hydraulic tool / applicable wire: AWG#12; crimp shape: hexagon)

*4 Mold (2155369-1 used together with the electric hydraulic tool / applicable wire: AWG#10; crimp shape: hexagon)

*5 Mold (2155369-1 used together with the electric hydraulic tool / applicable wire: AWG#8; crimp shape: hexagon)

*6 Mold (2155369-1 used together with the electric hydraulic tool / applicable wire: AWG#6; crimp shape: hexagon)

The receptacle contact can be used in all receptacle housings, the tab contact can be used in all tab housings

NOTE: All products are RoHS compliant On selection.

D-7100 – 16mm pin pitch

Type Chart



Pos	Color	Receptacle housing	Tab housing	Plating	Board-Mounting Header
4	Black	2134055-1	2134057-1	Silver	1981823-1

Relative Product Information

Applicable contact...P.110

Performance & Specifications...P109

External Dimensions

- Receptacle Housing

4P Model: 2134055-1

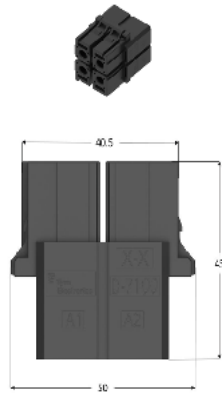

- Tab Housing

Panel type

4P Model: 2134057-1

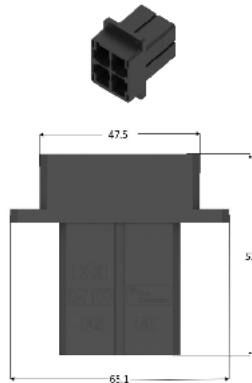

- Board-Mounting Header

4P Model: 1981823-1

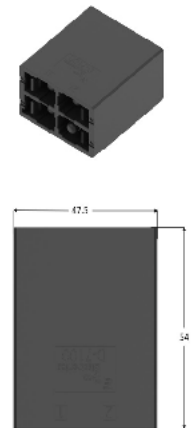

NOTE: All products are RoHS compliant On selection.

D-7300 – 16mm pin pitch

Type Chart

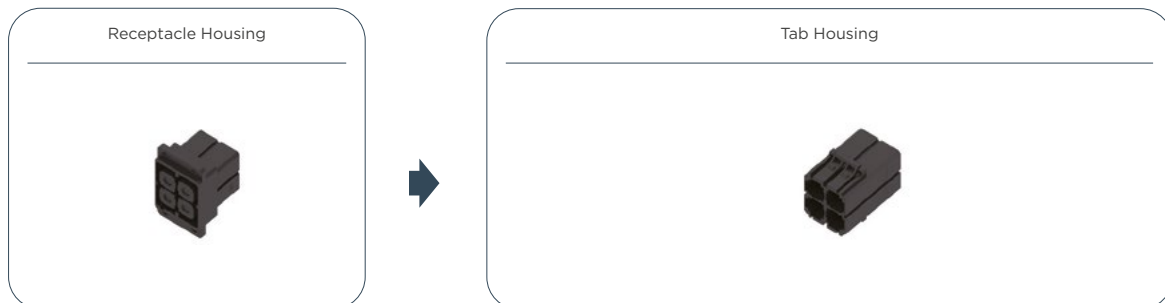

Pos	Color	Receptacle housing	Plating	Tab housing
4	Black	2134059-1	Silver	2134061-1

Relative Product Information

Applicable contact...P.110

Performance & Specifications...P109

External Dimensions

- Receptacle Housing

4P Model: 2134059-1

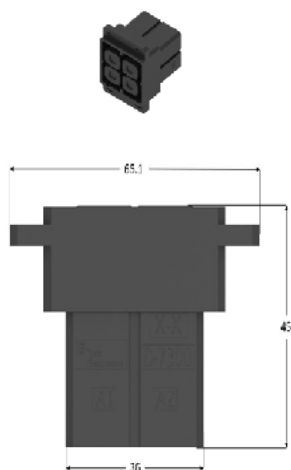

- Tab Housing

Panel type

4P Model: 2134061-1

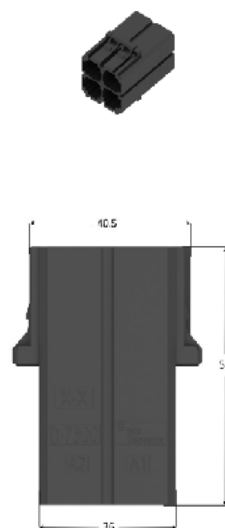

NOTE: All products are RoHS compliant On selection.

D-7100 Dyna-Clamp Kit - 16mm pin pitch

External Dimensions

- Receptacle Housing

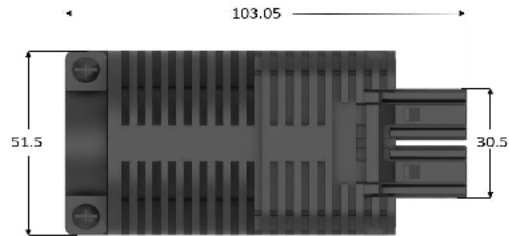

Pos	Color	Cable Size	Part Number
4	Black	S ø19 - 25	2-2069313-1
		M ø25 - 31	1-2069313-1

D-7300 Dyna-Clamp Kit

External Dimensions

- Receptacle Housing

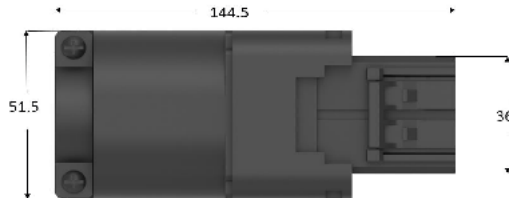

Pos	Color	Cable Size	Part Number
4	Black	S ø19 - 25	2-2069312-1
		M ø25 - 31	1-2069312-1

Relative Product Information

Applicable contact...P.110

Performance & Specifications...P109

Dynamic D-8000 Series

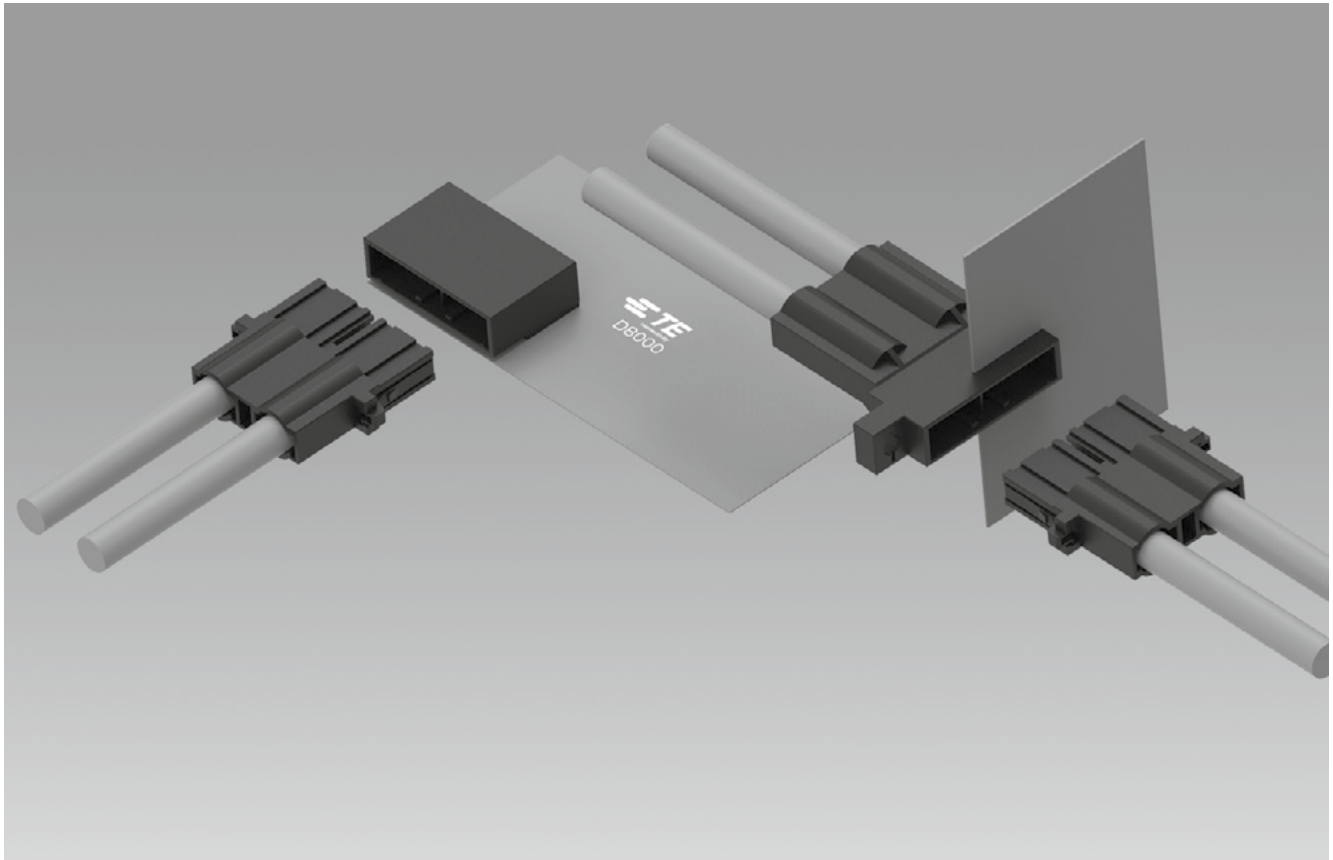

Series introduction

The D-8000 Series are by far the products with the largest current-carrying capacity in the Dynamic product line. The current-carrying capacity is up to 90A per unit for wire- to-board and 100A per unit for wire-to-wire.

The compact design provides more available space for applications requiring higher current-carrying capacity; the high temperature resistant board-end material can be applied to the reflow soldering process for easy uniformity on the client side.

D-8000 products, in line with the high reliability, small size and high cost performance that Dynamic products have always maintained, provide higher current-carrying capacity to meet the needs of the industrial market for high-current connectors.

Product Highlights

1. High current-carrying capacity
D-8000 products can reach 90A per unit for wire-to-board products and 100A per unit for wire-to-wire products. This product addition greatly improves the current-carrying range of the Dynamic product line.

2. Sequential Connection
Compared with the D-7000 products, the higher current carrying D-8000 connectors have a smaller size making them very cost- effective.

3. Silver-plated contact area of the terminal
D-8000 products balance the dual requirements of product performance and price, so the silver-plated contact design is used.

4. Board- Mounting Header suitable for reflow soldering
The D-8000's board-end connector is made of high temperature material and is suitable for reflow soldering. This allows for standardization and time savings on the soldering process.

D-8000 Series Performance and Specifications

Performance

Item	
Pin Pitch	24.4 mm
Rated Current	100A (wire-to-wire) / 90A (wire-to-board) max
Rated voltage	1000V
Withstanding voltage	3000V
Contact resistance	0.8mΩ max
Durability	10 cycles
Insertion force	58.8N max (per pos)
Extraction force	58.8N max (per pos)
Locking mechanism holding force	96 N
Retention force of contact in plastic housing	96 N
Wire Range	AWG 3
Operating Temperature	-55°C to 105°C

Product Specifications

Product manual	108-140254
Operation manual	114-78058-1
INSPECTION REPORT	501-78768

When using, be sure to order the instruction manual.
Also available from the electronic specification catalog on the Internet.

Positions / Wire size / Rated current

Unit: A (Amps)

Pos	Series	Cable Size (AWG)
		2
2	Wire-to-board	90
2	Wire-to-wire	100

Materials and Plating

Category	Material	Plating
Receptacle contact, tab contact	Copper alloy	Silver (2 μm) over nickel plated (1.27 μm) plated
Board-mounting tab contact	Copper alloy	Mating face: Silver (2 μm) over nickel plated (1.27 μm) plated Soldering face: Tin (2 μm) over nickel plated (1.27 μm) plated
Receptacle housing and tab housing	UL94V-0, PBT containing glass fiber	
Board-end housing	UL94V-0, high temperature nylon containing glass fiber	

D-8000 Series Contact

Crimp Contacts



Silver-plated type

Wire Range		Outer Diameter of Insulation mm	Contact		Applicable Tools
AWG	mm ²		Receptacle Contact	Tab Contact	
3	25	9.5	2373747-5	2351982-5	2372716-1

Note: When ordering products, please confirm the sales lot.
Please contact your agent or sales department for details.

Receptacle contacts are available for all receptacle housings, and the tab housings are available for all tab housings.

Dynamic D-8000 – 24.4mm pin pitch

Type Chart

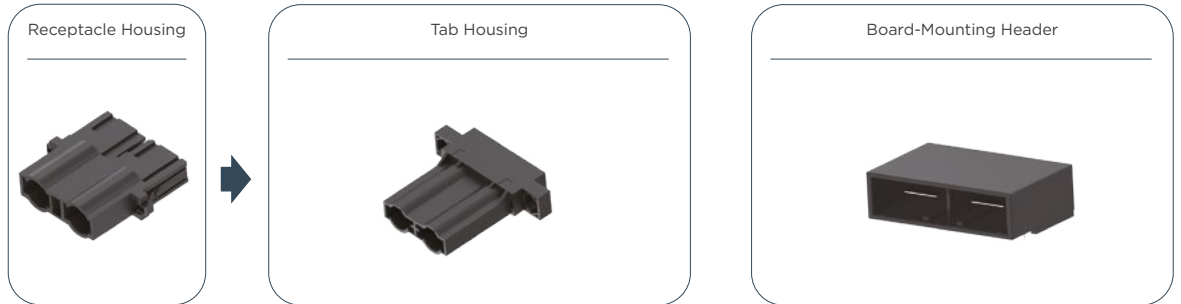

Pos	Color	Receptacle Housing	Tab Housing	Plating	Board-Mounting Header
2	Black	1-2351981-2	1-2352216-2	Silver	1-2351965-2

Relative Product Information

Applicable contact...P.116
Performance & Specifications...P.115

Mated Dimensions

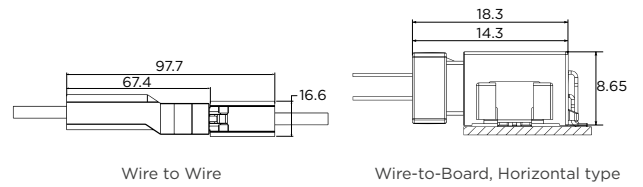

External Dimensions

- Receptacle Housing

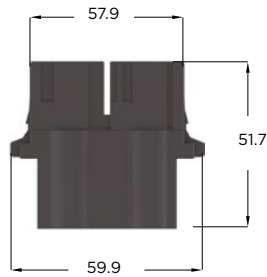

- Tab Housing

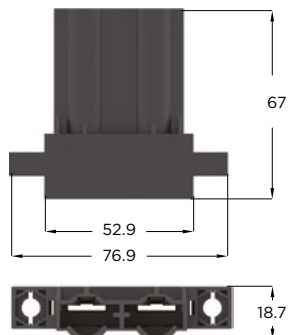

- Board-Mounting Header

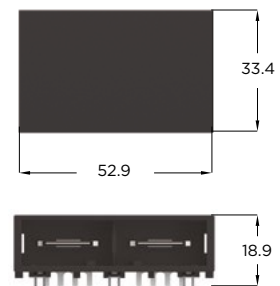

NOTE: All products are RoHS compliant On selection.

Multiple Enclosure Connector

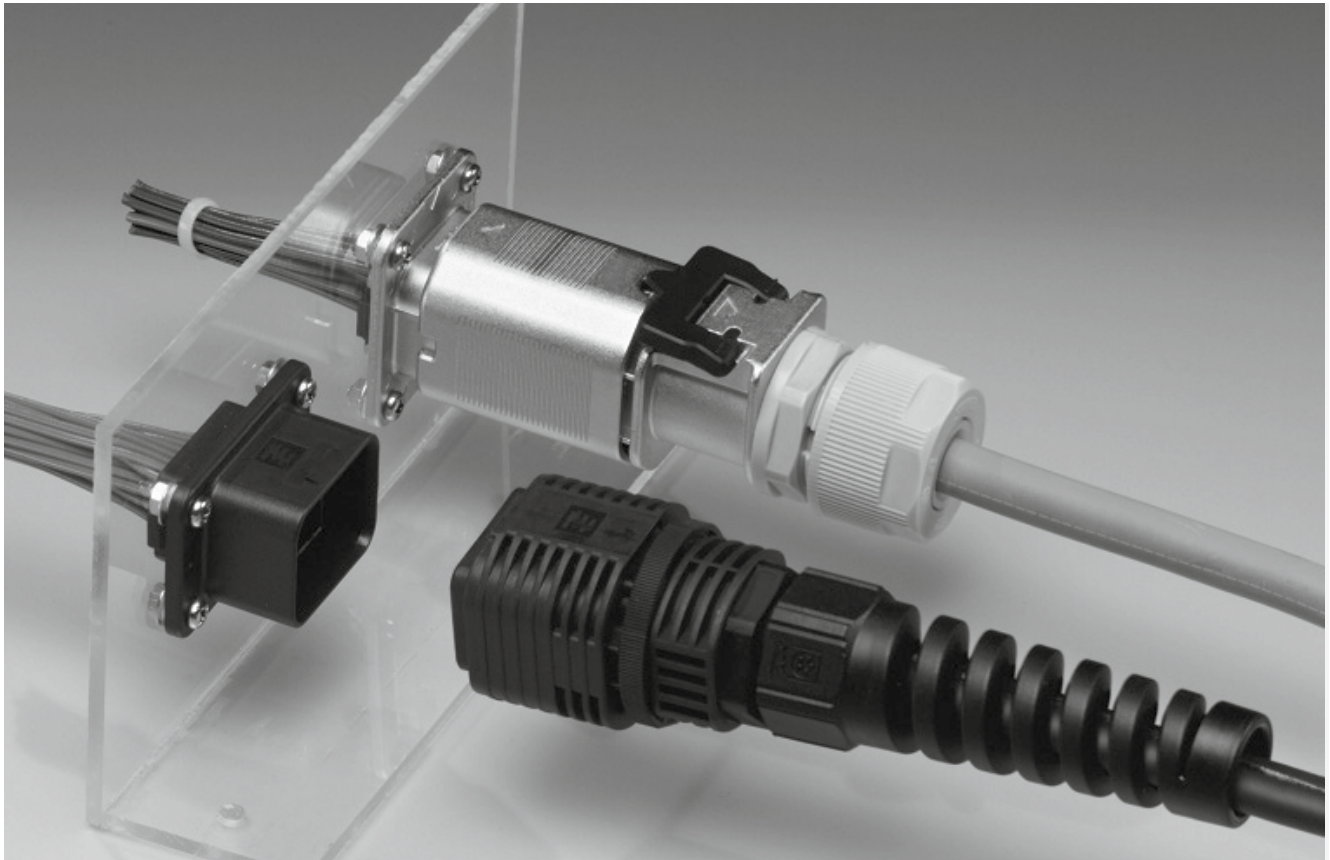

Series introduction

Human machine interfaces (HMI) can be found on a variety of machines. They allow people to communicate with equipment to control, operate and program. The multiple enclosure connector was developed as a connector for I/O interfaces for HMI.

They are superior in operation, very safe and easy to use. Plus, they use contacts from the Dynamic Series, providing high reliability.

There are two types of Multiple Enclosure connectors: metal and plastic. Their use depends on the type of environment.

Product Features

1. Wire Sizes

The metal type fits wires with diameter from 10mm to 11mm, the plastic type from 5mm to 12mm.

2. Applicable Contacts

The highly reliable Dynamic D-1000 and D-3000 series terminals are used as contacts for I/O connectors for human machine interfaces (HMI). These can be crimped by using existing Dynamic crimping tools.

3. IP65 (plastic type), IP67 (metal type) i

The connectors have dust and water proofing for use in harsh conditions. (Note: need to be used with cable gland)

4. Safety Lock Mechanism

The lock mechanism uses the fast on/off lock concept which can be locked or released by just grabbing the connector. Plus, our proprietary double lock mechanism prevents vibration related disconnect accidents.

5. Two Types of Housing

The series includes two types of housing, a standard type and a reverse type for preventing exposure of live contacts.

6. Cable Clamp Interface

C cable clamps, which are commercially available and can be selected according to application and purpose, can be attached to cover the cable entering the connector.

7. Other Considerations

Audible & tactile locking design ensure the complete connection between receptacle and tab.

Multiple Enclosure Connector

Performance Specifications

Item	Standard
Rated Current	See the reference
Rated Voltage	125VACrms (for the part with a pitch of 2mm)
Dielectric Withstand Voltage	1,000V AC (1 min)
Operating temperature	-30°C -105°C (including the temperature rise caused by electrification)
Total resistance(low level)	10mΩ max (initial)
Insulation resistance	1000mΩ min (initial)
Insert Strength	39.2N max (per position)
Withdrawal Strength	4.9N max (per position)
Durability	50 cycles
Enclosure Lock Strength	98N min

Product Specifications

Product Standards	108-78417
Applications Specifications	114-5377
Manual	411-78287,78288(14+1P) 411-78262,78277(24P)

Plastic type

Product Standards	108-78566
Mounting Application Standard	114-5377
Manual	411-78293(32P)

Contact

Refer to D-1000 contact on P.21
and D-3000 contact on P.48

Positions / Wire size / Rated current

Contact	Receptacle contacts and tab contact						
Wire Size	AWG #18	AWG #20	AWG #22	AWG #24	AWG #26	AWG #28	AWG #30
24Pos	—	—	2	1.5	1	0.8	0.5
14+1Pos	3.5	2.7	2.5	2	1.5	1	0.8

Plastic type

Contact	Receptacle contacts and tab contact				
Wire Size	AWG #22	AWG #24	AWG #26	AWG #28	AWG #30
32Pos	1.5	1	0.8	0.5	0.5

Materials and Plating

Metal type

Parts Materials	Materials	Finish
Contact	Copper alloys	Gold plating over Nickel under-plated
Connector Housing	UL94V-0, thermoplastic polyamide	—
Connector Case	Zinc	Nickel-plated
Bottom	Nitrile rubber	—
Shield Grip	Cold-rolled steel	Nickel plating over copper base

Plastic type

Description	Materials	Finish
Contact	Copper alloys	Gold plating over Nickel under-plated
Connector housing	UL94V-0, thermoplastic polyamide	—
Connector Case	UL94V-0, thermoplastic polyamide	—
Bottom	Nitrile rubber	—

Multiple Enclosure Connector

Type Chart



Type	Pos.	Receptacle housing	Polarity	Housing		Tab housing
				Receptacle (R) / Tab (T)	Tab housing	
Metal housing type	24	1939847-1	Standard	1939850-1(R)	1939839-1(T)	1939840-1
		1981560-1	Reverse	1981556-1(T)	1981551-1(R)	
Metal housing type	14+1	1939847-1	Standard	1981135-1(R)	1981133-1(T)	1939840-1
		1981560-1	Reverse	1981947-1(T)	1981945-1(R)	
Plastic housing type	32	1981919-1	Standard	1981921-1(R)	1981914-1(T)	1981913-1
			Reverse	2013393-1(T)	2013391-1(R)	

Shield clip P /N 1939851 -1 (Receptacle housing) tool: 1891820 -1 (411-78273)

Relative Product Information

Applicable contact... 24 position product: D-1000 S.M contacts see P.21
 14+1 position product: The D-1000 & D-3000 contacts see P.21 and 48
 32 position product: D-1000 S.M contacts see P.21

External Dimensions

• Receptacle Housing

Standard Type (Receptacle housing)

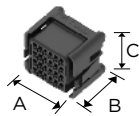

Pos	Key	Plating	Color	Part Number	Dimensions		
					A	B	C
24	—	—	Black	1939850-1	19.6	15.3	16.8
14+1	—	—	Black	1981135-1	22.0	22.8	
32	—	—	Black	1981921-1	27.2	15.3	17.6

Reverse (Tab housing)

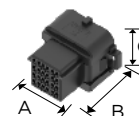

Pos	Key	Plating	Color	Part Number	Dimensions		
					A	B	C
24	—	—	Black	1981551-1	27.5	23.7	20.2
14+1	—	—	Black	1981945-1		23.7	
32	—	—	Black	2013391-1	29.5	23.0	17.0

• Tab Housing

Standard Type (Tab housing)

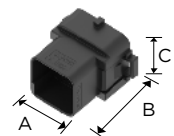

Pos	Key	Plating	Color	Part Number	Dimensions		
					A	B	C
24	—	—	Black	1939839-1	27.5	23.3	20.0
14+1	—	—	Black	1981133-1	27.3	27.5	20.2
32	—	—	Black	1981914-1	29.5	22.3	17.0

Reverse (Receptacle housing)

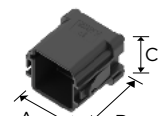

Pos	Key	Plating	Color	Part Number	Dimensions		
					A	B	C
24	—	—	Black	1981556-1	19.6	20.8	16.8
14+1	—	—	Black	1981947-1	22.8	28.2	
32	—	—	Black	2013393-1	27.2	20.0	17.6

NOTE: All products are RoHS compliant On selection.

Applicable Tools

AMP – 3K/AMP – 5 K Tabletop Crimping Machine.

AMP – 3K/AMP – 5 K is a compact, low-cost desktop crimping machine. A DC motor linear scheme is used for low noise, and motor speed adjustment can be easily changed. It offers a wide range of crimping operations options with simple operation and a comfortable working environment.

- It can be equipped with other companies' application tools.
- The crimping height can be adjusted at 0.013 mm per step.
- It can be used with a power supply of AC100V/240V.
- Low noise and easy speed adjustment are achieved due to the DC motor drive.
- Multiple modes and optional parts are available depending on the operating environment.

Name		AMP-3K	AMP-5K
Part Number	Type Universal mount type	1725950-3	1725900-3
	AMP quick mount type	1-1725950-2	1-1725900-2
Stroke		30 mm	
Dimensions		The application tool is mounted on the safety cover closed side (no reel): 512mm (width) x415mm (depth) x510mm (height)	
		The application tool is mounted on the safety cover closed end (no reel): 427mm (width) x523mm (depth) x510mm (height)	
Weight		About 70kg (main body of the crimping machine)	
Power supply		AC100-240V (310%) Single-phase 50 / 60Hz (6A)	
Cycle time		0.4 s (when the jog mode is terminated)	



SCM Stripper Crimping Machine (Tabletop Crimping Machine)

Stripper Crimping Machine with exchangeable Dies. With optimum processing of jacket cable ends, the operator selects among strip and crimp, strip only or crimp only with one touch.

Type	AMP-3K Specification 1596509-3	AMP-5K Specification 1596509-4
Applicable Wire	AWG 32-14 with the maximum skin outer diameter of 5.08mm (some AWG32-30 wires are inapplicable.) Please contact us for details.	
Jacket strip Dimensions	Min 29mm (or wire set if the peeling size is 29-45mm) The time is longer than usual.	
Strip Length	2.5-10mm	
Usable Applicators	Our company's 40mm stroke side feed application tool	
Noise level	< 82 dB	
Crimp ability	13,345N (1,360kgf) Can be crimped to the AWG14	22,226N(2,268kgf) Can be crimped to the AWG10 (or to AWG14, if it is an SCM)
Power supply	AC 100-240V single phase 50/60Hz	
Air pressure	0.49 - 0.59MPA (5 - 6kg/cm2)	
Machine weight	About 80 kg	

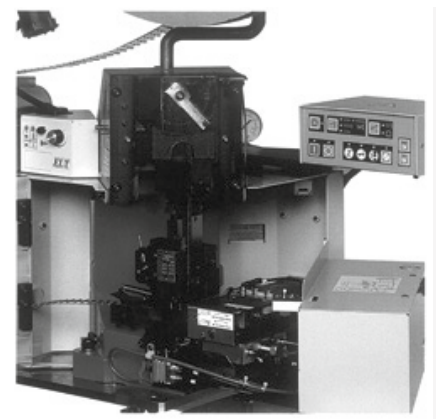

AMP-3K Specification SCM

Dynamic Series Connectors

2024 Edition

Applicable Tools

TE REC-Li60 (charging hydraulic tool)

- The lithium-ion battery is the lightest in its class.
- High power due to dual Battery-electric & hydraulic pump use.

Product Specification Rated output 54 kN Crimp Range: 5.5 to 60mm²
Electric machine: 14.4 V DC motor
External dimensions 286 mm (length) x 285mm (height) x 75mm (width)
Weight: 2.7 kg (60 mm² Dices, battery pack included)
No. of times can be crimped: 270 times (60 mm² crimp per hour), Manufacturer Part Number: 2155369 - Δ

TE REC-Li 250 M (charging hydraulic multi- function tool)

Product Specification Rated output 127kN
Crimp Range: 14 to 250 mm² (copper wire bare pressure terminal and sleep)
Electric motor: 14.4 V DC motor
External dimensions 340mm (length) x 280mm (height) x 75mm (width)
Weight: 4.2kg (250mm² Dices, battery pack included)
No. of times can be crimped: 50 times (250mm² crimp per hour), Manufacturer Part Number: 2155363 - Δ



Key Plug-equipped D-1000 Series



Part Number:1939588-1

Receptacle Contact Cutting Tool D-1000 Series

Part Number: 919041-3
Application Specification: 411-78047

Key Plug-equipped D-2000 Series

(Used to prevent misinsertion)
Avoid mis-plugging when connectors with the same No of Pos. are used together.



Part Number:641994-1

Receptacle Contact Cutting Tool D-2000 Series

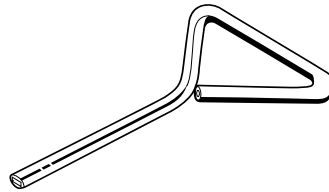

Part Number: 919041-2
Application Specification: 411-78047

Key Plug-equipped D-3000 Series

(Used to prevent mis-plugging)
Avoid mis-plugging when connectors with the same No of Pos. are used together.



Part Number:175855-1

Receptacle Contact Cutting Tool Series D-3000

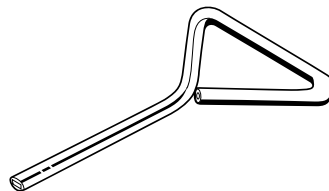

Part Number: 919041-1
Application Specification: 411-78047

Applicable Tools

How to use the plug and cutting tool

*It should be noted that some of the products (D-2100 S/D-2100 D) to prevent mis-insertion, use keying mechanism from the beginning.

- ① Keying Plug inserted in one pole of the receptacle housing.

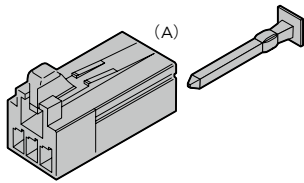

- ② Wrench off a tab in the corresponding position of mating Tab Header and empty that position. To wrench off the tab, insert Cutting Jig into its root and turn tool as shown.

**In tab Housing (Panel / freehanging type), 1 pole is not inserted and is left free.

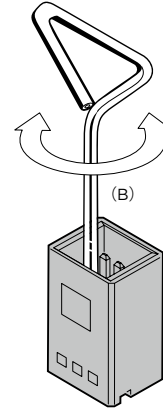

How to use the plug and tool for the D-3000 Series

In addition, mis-insertion function keying has been installed from the beginning in some of the products (D-3100S/ D-3100M/ D-3200S/D-3200M)

- ① The keying plug is inserted into the receptacle housing

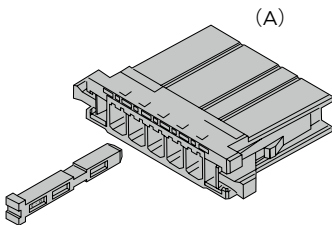

- ② Wrench off a tab in the corresponding position of mating Tab Header and empty that position. To wrench off the tab, insert Cutting Jig into its root and turn tool as shown

* In tab Housing (Panel / freehanging type), 1 pole is not inserted and is left free

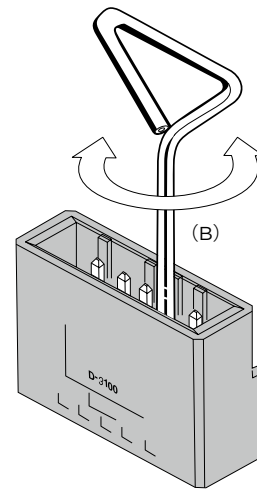

- ③ When using these, it is impossible to mis-insert

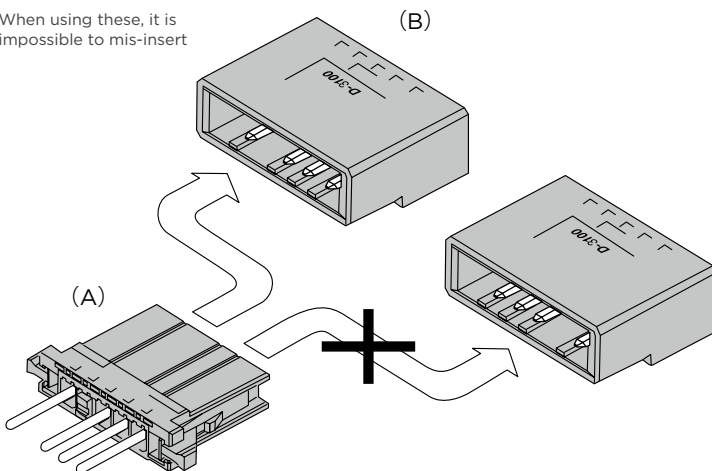

Applicable Tools

Hand tools PEW 12, D-1000, D-3000 and D-4000 series



- Crimping with a straight action feel
- By manipulating the fulcrum of the handle, we have created a crimper that, while double action, is almost like straight action.
- Interchangeable dies
- The dies are easy to change. This means a wide variety of terminals can be handled with the minimum number of tools.
- Improve work efficiency
- Contact series, wire sizes and crimp heights printed on work surface of dies.
- Lower cost than existing specialized tools
- The superior functionality you want, at a price you like.

Hand Tools CERTI-CRIMP II, D-1000 Series Flip Locator, D-2000 Series, D-3000 Series, D-5000 Series

Crimp part, as well as the machine, are highly reliable, Straight action method is introduced.

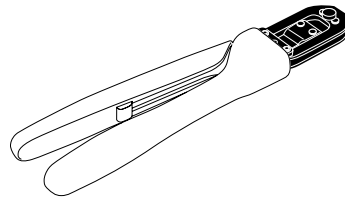

D-1000 series with Flip Locator

Part Number: See P.17,36,46,90.

- Handles are completely covered in urethane providing an easy grip and gentle on hands.
- Wire ranges and crimping height control values are printed on the crimping head for easy confirmation while working. Also, the ratchet in the handle keeps crimping quality very consistent.
- Hand crimping tool with wire stripper has four variations, while the previous model had only three variations.
- We recommend periodic maintenance when using hand crimping tools to keep crimping quality consistent.

Hand Tool D-4000 Series

Crimper uses the reliable straight action method

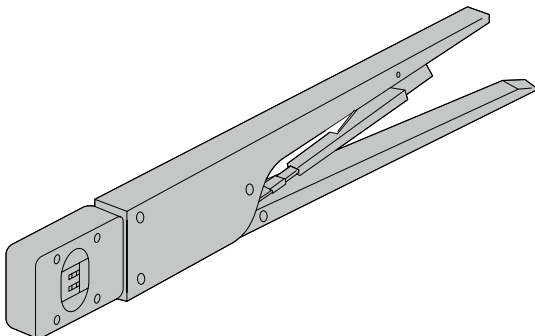

Part Number: See P.83

Applicable Tools

Hand Tool D-5000 Series

As with machine use, the reliable straight action method is used.

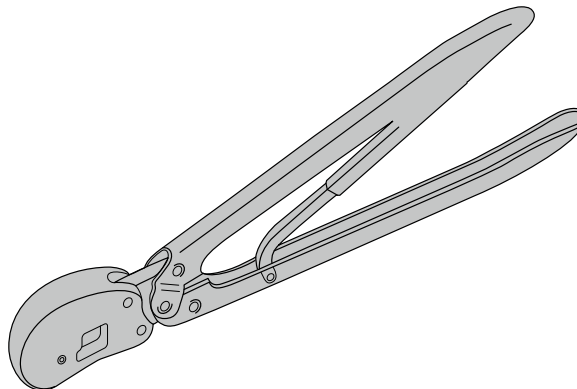

Part Number: See P.90

Extraction Tool for D-1000 Series

Used to pull D-1000 from the housing



Part Number:1891526-1
Manual: 411-78241

Extraction Tool for D-2000 Series

Used to pull D-2000 contacts from the housing



Part Number:1276716-1

Applicable Tools

Extraction Tool for D-3000 Series

Wiring type tool for pulling the contact from the housing

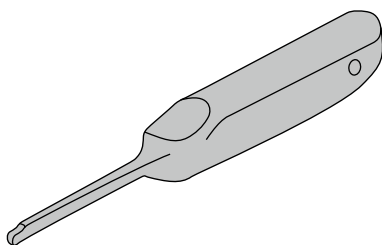

Model: 234168-1
Operating Manual: 411-5726

Using the extractor

- 1 Extractor tool is inserted into the small, upper part of the convex hole in the housing as shown in the diagram (please hold the tool the right way up)

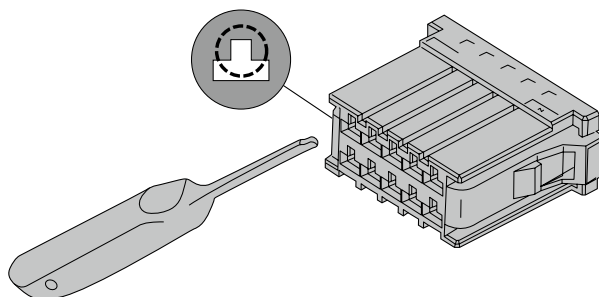

- 2 The tip of the tool lifts the housing lance and frees the contact

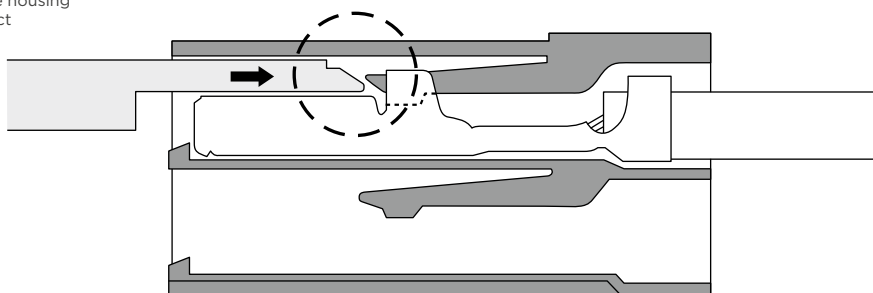

- 3 Contact can be withdrawn

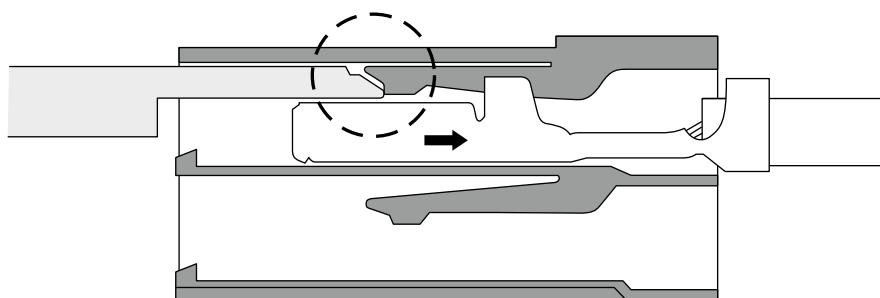

* Take care not to insert into the Contact Section. If you have inserted by error, replace the damaged contact with a new one before proceeding.

Applicable Tools

Extraction Tool for D-5000 Series

A tool for pulling out terminals from cable's crimping plug/socket housing. (When inserting, please note that the positioning dowels of D-3 and D-5 are opposite up and down.) Only D-5 terminals can be pulled out with a tool such as a small flathead screwdriver or awl.

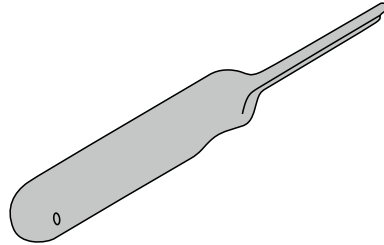

Part Number: 409158-1
Operation Manual: 411-5774

Using the extractor

- 1 The pulling tool should be inserted into the narrow part of bottom, with convex hole in the housing as shown in the diagram.

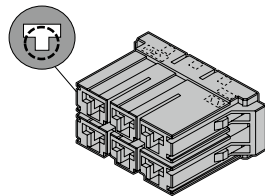

If using the D-5 Extraction Tool

- 2 The tip of the tool lifts the housing lance and frees the contact

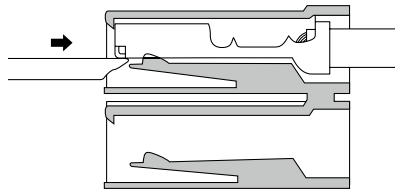

- 3 Contact can be withdraw

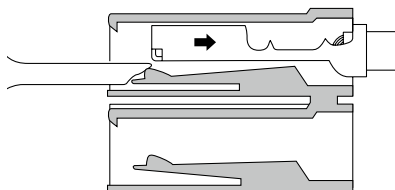

If using a small O-driver or awl

- 2 The tip pushes down the lance part and frees the contact

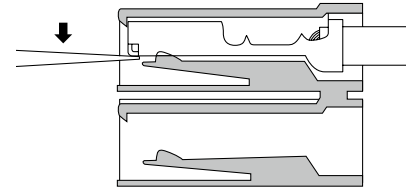

- 3 Contact can be withdraw

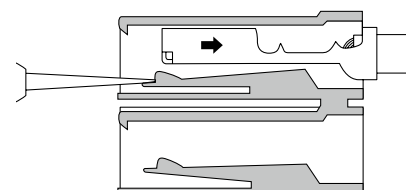

Unplugging tool D-7000 series

Part Number: 2040080-1
Operation Manual: 408-78147



Please be sure that it is not inserted into the terminal position. If it is inserted incorrectly, replace the terminal with a new one.

Crimping Oil

Part Number:939691-1

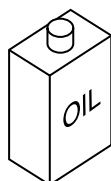

For easing the friction between tool and contact during crimping

Sequence clip

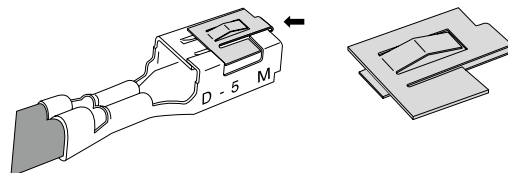

- First "On" / then "Off"
- Applicable to the D-5 terminal only

Part Number:179993-1

Accessories

L-bracket D-3000

Used to fix the air-to-air housing of the plug to the panel surface.

Model: 5900121-2(S)

5900121-4(L)



Part Number:5900121-2 (S)



Part Number:5900121-4(L)

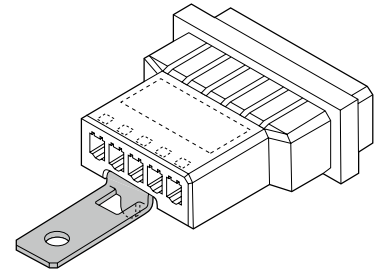

Push rivets

Used to secure panel-type tab housings onto panels (Use as a handy mounting hardware).

Cannot be used with larger sized housings or those that are frequently inserted and withdrawn).

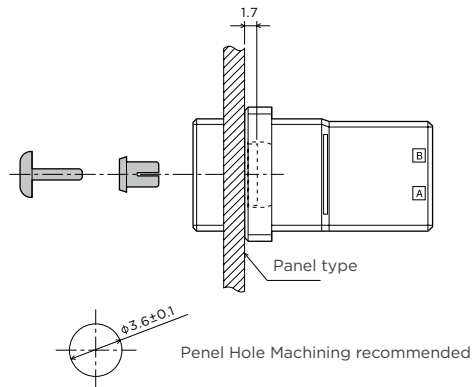
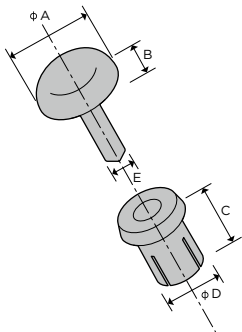

Part Number	Panel Thickness	Dimensions					Insertion Strength	Retention Force
		6.4	B	C	D	E		
900128-1	0.3-1.3	6.4	1.6	4.5	3.5	1.95	19.6N-29.4N	127.4N Min.*
900128-2	1.3-2.3			5.5				

*When using 2

Panel Mounting Screws D-2000, D-3000

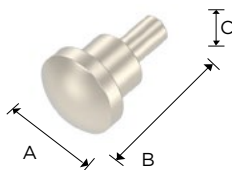

Part Number	Dimensions		
	A	B	C
900167-1	9.0	10.3	M3

Panel Mounting Hex Screws D-2000

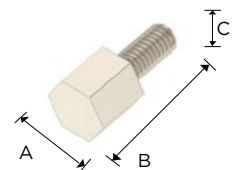

Part Number	Dimensions		
	A	B	C
1376059-1	5.5	12.3	M3

Cable Glands

Plastic Gland



Material: PA
 Press seal material: PA
 Seal material: EPDM
 Temperature range: -40°C~+100°C
 Protection: IP68

Metr.	Dimension D		SW	Type	Part Number	Color of Housing
	Minimum	Maximum				
M20*1.5	5	9	24	HSK-M20B-H	T3209201112-001	Black
	6	12		HSK-M20B	T3209201122-001	
	8	14		HSK-M20B-D	T3209201102-001	
	5	9	24	HSK-M20G-H	T3209201212-001	Grey
	6	12		HSK-M20G	T3209201222-001	
	8	14		HSK-M20G-D	T3209201202-001	

Metal Gland



Material: Nickel plated brass
 Press seal material: PA
 Seal material: NBR
 Temperature range: -40°C~+100°C
 Protection: IP68

Metr.	Dimension D		SW	Type	Part Number
	Minimum	Maximum			
M20*1.5	5	9	22	DLX-20-MT	T3609200112-000
	6	12		DLX-20-M	T3609200102-000
	10	14	24	DLX-20-MB	T3609200122-000

EMC cable glands



Material: Nickel plated brass
 Press Seal Material: PA
 Temperature range: -40°C~+100°C
 Protection: IP68

Metr.	Dimension D		SW	Type	Part Number
	Minimum	Maximum			
M20*1.5	5	9	24	DLX-20-MTC	T3707200113-000
	7	12	22	DLX-20-MC	T3706200103-000

请使用互联网电子规格目录。
INTERNET Electronic Catalog Offered For Your Use.

www.te.com

本电子规格目录可根据“型号”“产品名称”“产品类型”等进行搜索，可在短时间内搜索到符合特定规格的产品。包括客户图纸在内，可简单提取到详细信息。采用时，请务必下载客户图纸后使用。

Using this Electronic Catalog, you can retrieve information by product category, part number and product name. It is possible to search and locate information on products that meet specific specifications in minutes. Customer drawings included, detailed product information can be extracted easily.

操作步骤
(Electronic Catalog Procedure)

可查阅RoHS标准。
You can search for the RoHS regulation information.

- 1 访问上述地址，出现右边的窗口；
Upon the access to our website, the following page will come appear.
- 2 光标对准产品信息，出现菜单。单击产品搜索，出现以下窗口，显示操作方法示例，请按需求方式进行搜索。

Moving the cursor here takes you to the product search menu. If you select the product search menu, the following page will show you examples of how to operate. Please operate with the suitable method to your needs.



单击此处，弹出右边窗口。
Click this button to get the page shown right.



输入产品型号，单击搜索，出现右边的窗口。(※171825-2为型号输入示例。)
After entering part number, click Search to get the page shown right.
※171825-2 is an example of part number for entering.

Documents and Drawings for: 171825-2

Document Title	Document Type	Document ID	Add to Package
007 (Rev. 04/2014) (E) Series Connector (M, Pin)	Product Specification	108-8339	<input type="checkbox"/>
007 (Rev. 04/2014) (E) Series Connector (M, Pin)	Product Specification	108-8339	<input type="checkbox"/>
Customer Sales Manual (M, Rev. 04/2014)	Manual	171825-2	<input type="checkbox"/>
Customer Sales Manual (M, Rev. 04/2014)	Manual	171825-2	<input type="checkbox"/>
Customer Sales Manual (M, Rev. 04/2014)	Manual	171825-2	<input type="checkbox"/>



- Product specifications may be changed for improvement purposes without prior notice. Sales of any of the products may be suspended. When discussing the use of products, be sure to request for the drawings and product Standard Type Type Types. In particular, please consult the information to confirm the tolerances of the fine mounting dimensions for the mounting of the printed circuit board.
- The product is provided with a sales batch. Please ask the sales department for the latest information.

- Dimensions, if not specified, are expressed in mm.
- The applicable wire range (AWG) contained in this specification catalogue covers the values for using the application tools. When using a hand tool, please refer to the operating manual.

Connect With Us

We make it easy to connect with our experts and are ready to provide all the support you need, including:

- Help finding product information
- Assistance with sample orders
- Direct access to TE engineers and product experts
- Consulting on a project
- Help using TE design resources

Visit [te.com](https://www.te.com) to chat with a Product Information Specialist.

te.com

©2024 TE Connectivity. All Rights Reserved.

TE Connectivity, TE connectivity (logo) and Every Connection Counts are trademarks. BUCHANAN, Corcom, ENTRELEC, ERNI, FASTON, Flexstrip, Grace Intertia, htec, Intercontec, itec, locktec, MATE-N-LOK, MaxiBridge, MicroCon, Micro-MaTch, MicroSpeed, MicroStac, MiniBridge, OEG, PIDG, PLASTI-GRIP, Potter&Brumfield, Power Versa-Lock, Raychem, SCHRACK, singletec, SOLISTRAND, SpeedTec, Versafit, are trademarks owned or licensed by the TE Connectivity Ltd family of companies.

All other logos, products and/or company names referred to herein might be trademarks of their respective owners.

While TE has made every reasonable effort to ensure the accuracy of the information in this brochure, TE does not guarantee that it is error-free, nor does TE make any other representation, warranty or guarantee that the information is accurate, correct, reliable or current. TE reserves the right to make any adjustments to the information contained herein at any time without notice. TE expressly disclaims all implied warranties regarding the information contained herein, including, but not limited to, any implied warranties of merchantability or fitness for a particular purpose. The dimensions in this catalog are for reference purposes only and are subject to change without notice. Specifications are subject to change without notice. Consult TE for the latest dimensions and design specifications.

AK 07/24

