

DO NOT SCALE FROM THIS PRINT

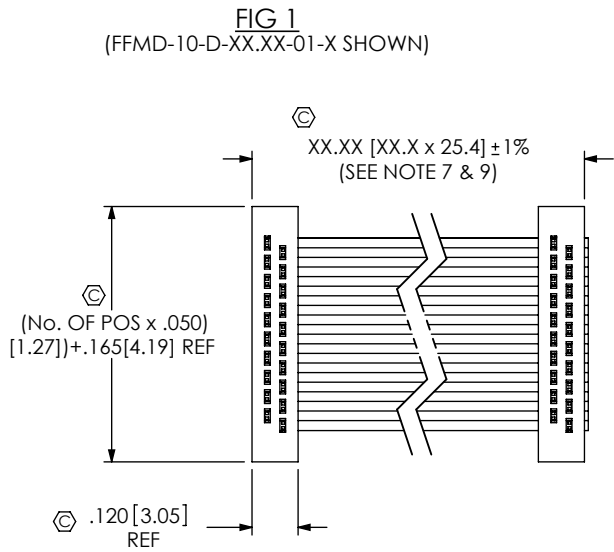

FFMD-XX-X-XX.XX-01-X-X-XXX

No OF POSITIONS
-03 TO -25

END ASSEMBLY
-D: DOUBLE END
-S: SINGLE END
*-T: TRANSFER END

ASSEMBLY LENGTH
(2.00[50.8] MINIMUM)

LEAD STYLE

PLATING OPTIONS
LEAVE BLANK FOR STANDARD
(USE T-1S57-01-T AND C-67-L)
-L: SELECTIVE LIGHT GOLD
(USE T-1S57-01-L AND C-67-L)
-F: FLASH SELECTIVE GOLD
(USE T-1S57-01-F AND C-67-F)
-S: SELECTIVE GOLD
(USE T-1S57-01-S AND C-67-S)

OPTION

-RW: REVERSE WIRING
-BXX: BREAKOUT OPTION
-O: OUTSIDE REVERSED
-M: MIDDLE REVERSED
-R: REVERSE
-DXX: DAISY CHAIN (MINIMUM 2.00[50.8] 1.00[25.4] INCREMENTS)
-SR: STRAIN RELIEF (NOT AVAILABLE WITH -O, -M, -R, -DXX OR -BXX) (SOLD AS ASSEMBLIES ONLY)

TRANSFER OPTION

-N: SOCKET HAS NOTCH POLARIZATION (-T END ASSEMBLY ONLY) (LEAVE BLANK FOR -S AND -D END OPTIONS) (NOT AVAILABLE ON POSITIONS -02 THRU -04)

*16-25 POS TRANSFER END STRAIN RELIEF NOT RELEASED FOR PRODUCTION

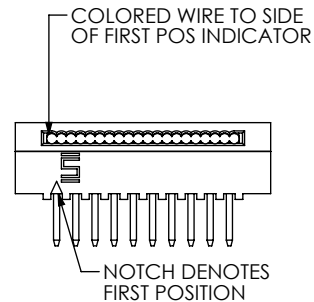
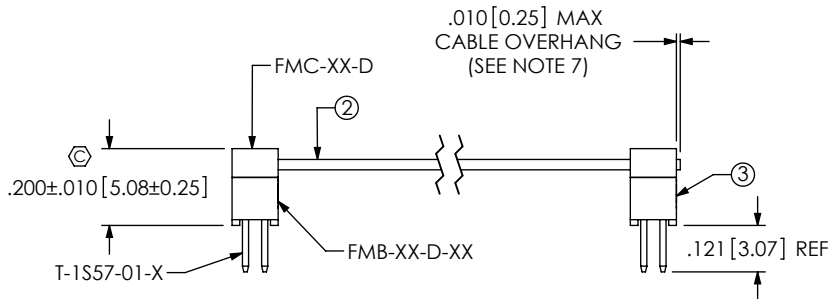

FIG 2
(FFMD-10-S-XX.XX-01-X SHOWN)
(SAME AS FIG 1, DIFFERENT AS SHOWN)

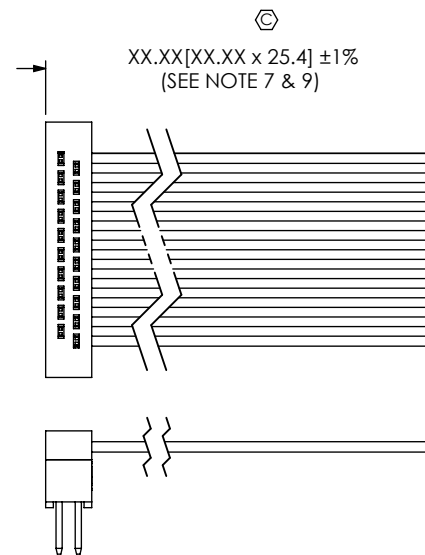

TABLE 1	
ITEM #	PART
1	FFSD-XX-XX-X-N
2	CB-XX-30-7
3	FFMD-XX-XX-X-XX
4	FFMD-XX-01-X-SR
5	FFSR-XX-01
6	FFSR-XX-02
7	FFSD-XX-XX-X-N-SR1
8	FFSD-XX-XX-X-N-SR2

NOTES:

- ① REPRESENTS A CRITICAL DIMENSION.
- FFSD ASSEMBLY TO BE USED FOR TRANSFER END ONLY.
- ③ ALL ASSEMBLIES TO BE 100% ELECTRONICALLY TESTED FOR SHORTS AND OPENS.
- ALL ASSEMBLIES TO BE 100% HI-POT TESTED AT 630V.
- STRAIN RELIEF TO WITHSTAND 5LB[22N] STRAIGHT PULL.
- FFMD CABLE ASSEMBLIES ARE LEAD FREE.
- WHEN CUTTING CABLE TO LENGTH, CONDUCTORS SHOULD NOT EXTEND PAST THE CABLE INSULATION, EXTENDING LESS THAN 25% OF CABLE THICKNESS ON CONSECUTIVE AND LESS THAN 50% OF CABLE THICKNESS ON NON-CONSECUTIVE STRANDS IS CONSIDERED A PROCESS INDICATOR.
- REFERENCE FFMD-XX-XX-X-XX (AND FFSD-XX-XX-X-N-XX FOR -T OPTION) DRAWING FOR CONNECTOR ASSEMBLY DIMENSIONS AND ITS REQUIREMENTS.
- FOR LENGTHS LESS THAN 12.5" TOLERANCE SHALL BE +/- .125, ALL OTHER LENGTHS SHALL BE +/- 1%.

F:\DWG\SW\Exisprod\Assembly\Cable\FFMD-XX-X-XX.XX-01-X-X-XXX-ASM.SLDDRW

UNLESS OTHERWISE SPECIFIED, DIMENSIONS ARE IN INCHES.
TOLERANCES ARE:
DECIMALS ANGLES
.XX: ±.01 [.3] 2°
.XXX: ±.005 [.13]
.XXXX: ±.0020 [.051]

PROPRIETARY NOTE

THIS DOCUMENT CONTAINS INFORMATION CONFIDENTIAL AND PROPRIETARY TO SAMTEC, INC. AND SHALL NOT BE REPRODUCED OR TRANSFERRED TO OTHER DOCUMENTS OR DISCLOSED TO OTHERS OR USED FOR ANY PURPOSE OTHER THAN THAT WHICH IT WAS OBTAINED WITHOUT THE EXPRESSED WRITTEN CONSENT OF SAMTEC, INC.



520 PARK EAST BLVD, NEW ALBANY, IN 47150
PHONE: 812-944-6733 FAX: 812-948-5047
e-Mail: info@SAMTEC.com code: 55322

MATERIAL: DO NOT SCALE DRAWING SHEET SCALE: 2:1
INSULATOR: PBT, COLOR: BLACK
CONTACT: BeCu
TERMINAL: PHOS BRONZE
WIRE: 30 AWG, 7/38, TINNED, STRANDED WITH PVC INSULATOR

DESCRIPTION:
.050 X .050 DOUBLE ROW MALE IDC CABLE ASSEMBLY

DWG. NO.
FFMD-XX-X-XX.XX-01-X-X-XXX

BY: T NEWTON 02/15/2008 SHEET 1 OF 5

FIG 3
(FFMD-10-D-XX.XX-01-X-SR SHOWN)
(SAME AS FIG 1, DIFFERENT AS SHOWN)

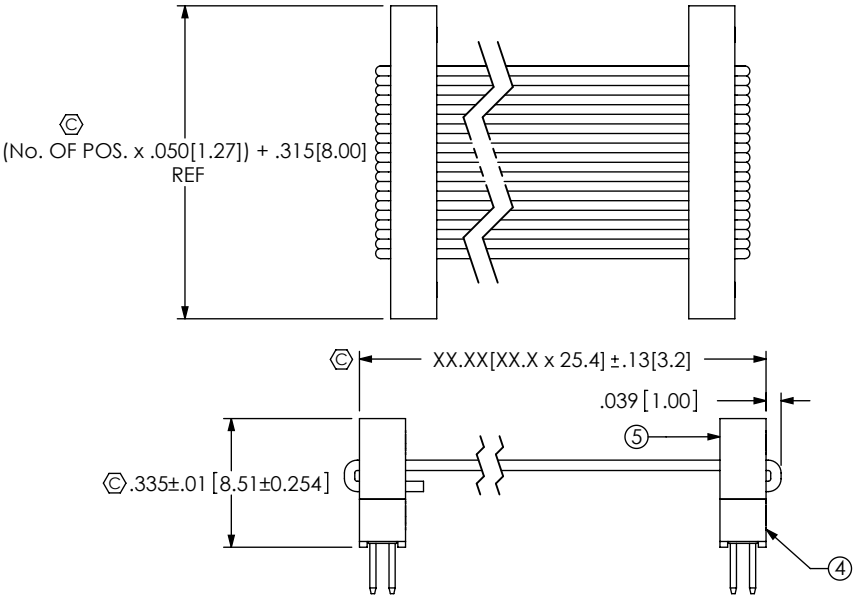

FIG 4
(FFMD-10-X-XX.XX-01-X-RW SHOWN)
(SAME AS FIG 1, DIFFERENT AS SHOWN)

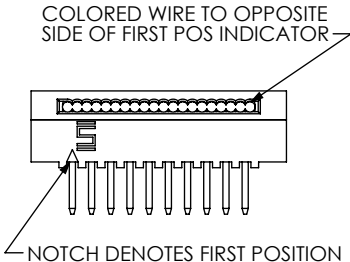

FIG 5
(FFMD-10-X-XX.XX-01-X-N SHOWN)
(SAME AS FIG 1 AND FIG 6, DIFFERENT AS SHOWN)
(FOR -T ONLY)
(IF OPTION IS SPECIFIED USE FFSD-XX-01-X-N)

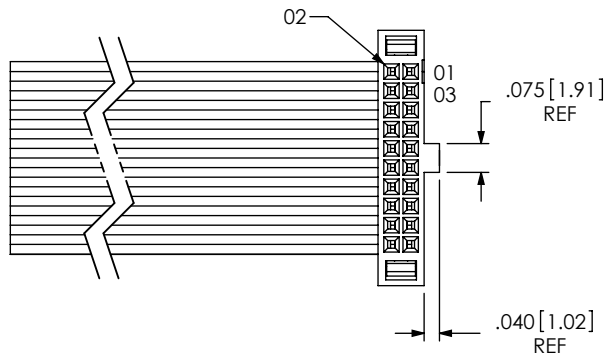

FIG 6
(FFMD-10-T-XX.XX-01-X-N SHOWN)
(SAME AS FIG 1, DIFFERENT AS SHOWN)

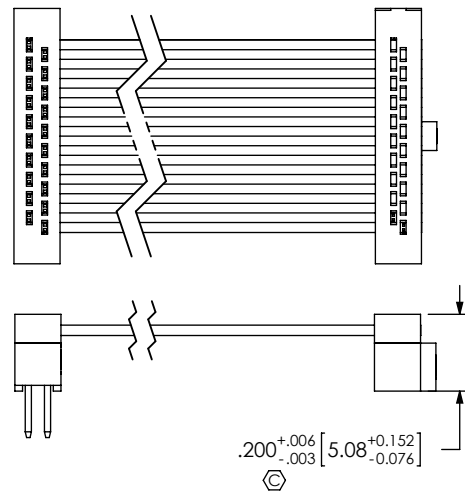
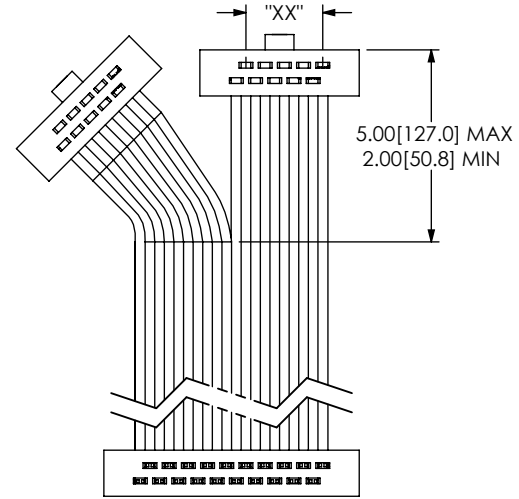
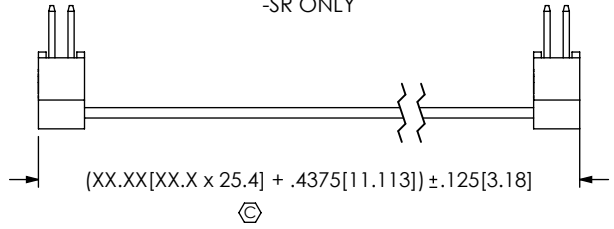

FIG 7
(FFMD-10-T-XX.XX-01-X-N-B05 SHOWN)
(SAME AS FIG 1 AND FIG 6, DIFFERENT AS SHOWN)
"XX" = NO. OF CONDUCTORS PER ROW
BROKEN OUT FROM THE FIRST POSITION



IN-PROCESS 1
-SR ONLY



IN-PROCESS 2
-SR ONLY

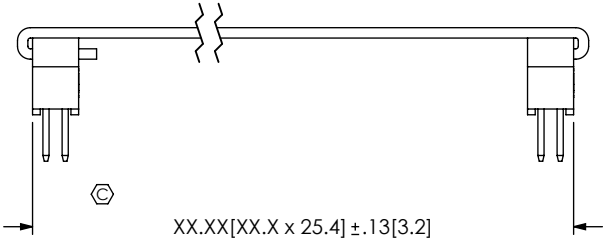

PROPRIETARY NOTE

THIS DOCUMENT CONTAINS INFORMATION CONFIDENTIAL AND PROPRIETARY TO SAMTEC, INC. AND SHALL NOT BE REPRODUCED OR TRANSFERRED TO OTHER DOCUMENTS OR DISCLOSED TO OTHERS OR USED FOR ANY PURPOSE OTHER THAN THAT WHICH IT WAS OBTAINED WITHOUT THE EXPRESSED WRITTEN CONSENT OF SAMTEC, INC.

DO NOT SCALE DRAWING

SHEET SCALE: 2:1



520 PARK EAST BLVD, NEW ALBANY, IN 47150
PHONE: 812-944-6733 FAX: 812-948-5047
e-Mail: info@SAMTEC.com code: 55322

DESCRIPTION:
.050 X .050 DOUBLE ROW MALE IDC CABLE ASSEMBLY

DWG. NO.
FFMD-XX-X-XX.XX-01-X-X-XXX

BY: T NEWTON 02/15/2008 SHEET 2 OF 5

FIG 8

(FFMD-10-D-XX.XX-01-X-DXX-O SHOWN)
 (SAME AS FIG 1, DIFFERENT AS SHOWN)
 (2.00[50.8] MINIMUM LENGTH, 1.00[25.4] INCREMENTS)
 (NOT AVAILABLE WITH -R OR -M OPTIONS)

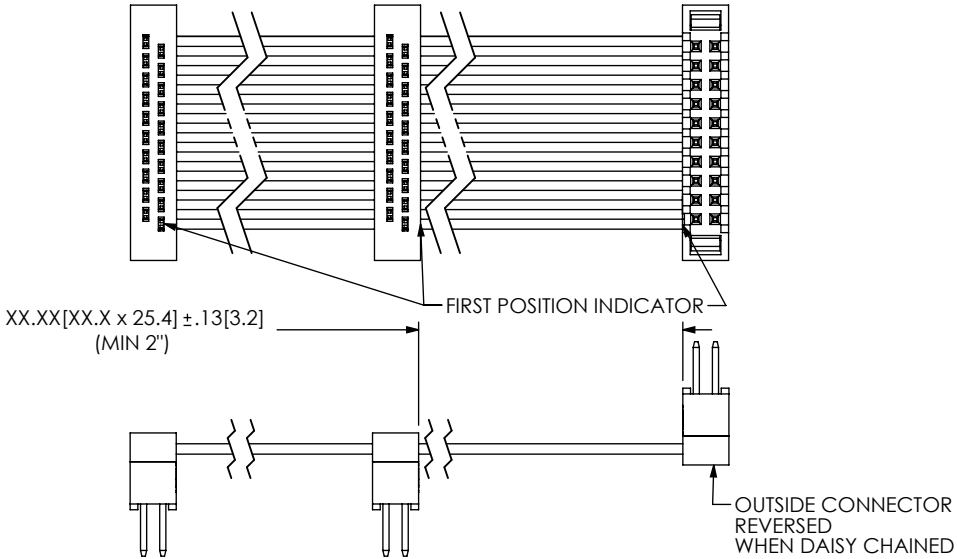

FIG 9

(FFMD-10-D-XX.XX-01-X-DXX-M SHOWN)
 (SAME AS FIG 1, DIFFERENT AS SHOWN)
 (2.00[50.8] MINIMUM LENGTH, 1.00[25.4] INCREMENTS)
 (NOT AVAILABLE WITH -R OR -O OPTIONS)

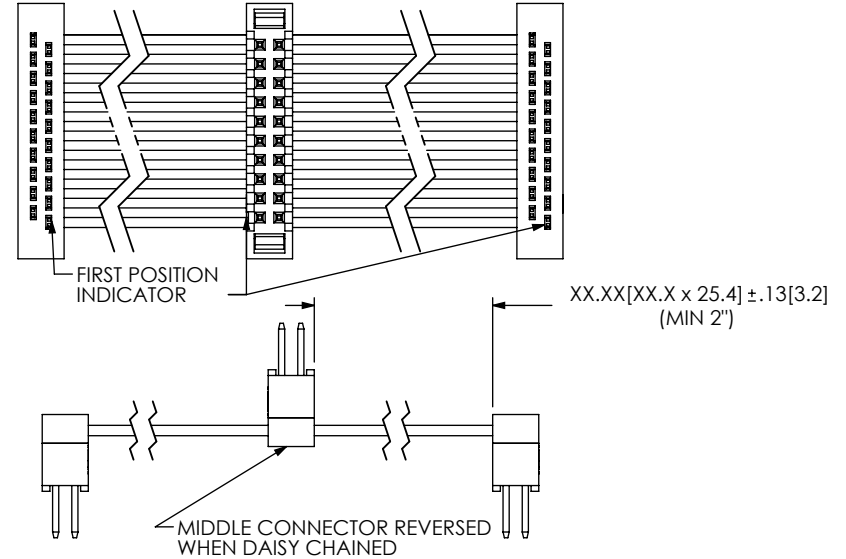

FIG 10

(FFMD-10-T-XX.XX-01-X-N-DXX-O SHOWN)
 (SAME AS FIG 1 AND FIG 6, DIFFERENT AS SHOWN)
 (2.00[50.8] MINIMUM LENGTH, 1.00[25.4] INCREMENTS)
 (NOT AVAILABLE WITH -R OR -M OPTIONS)

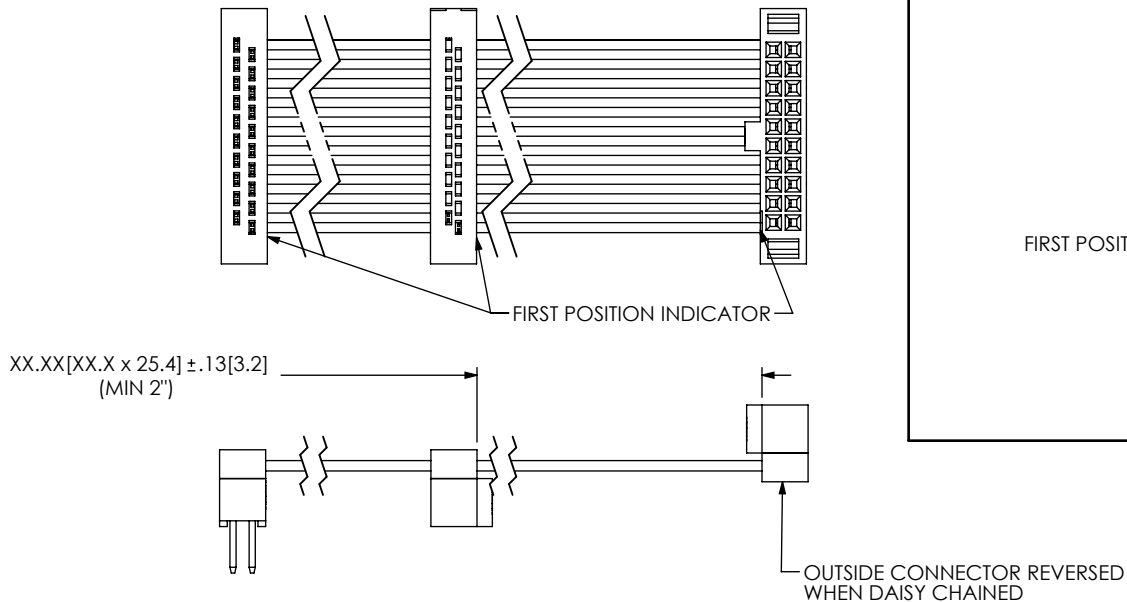
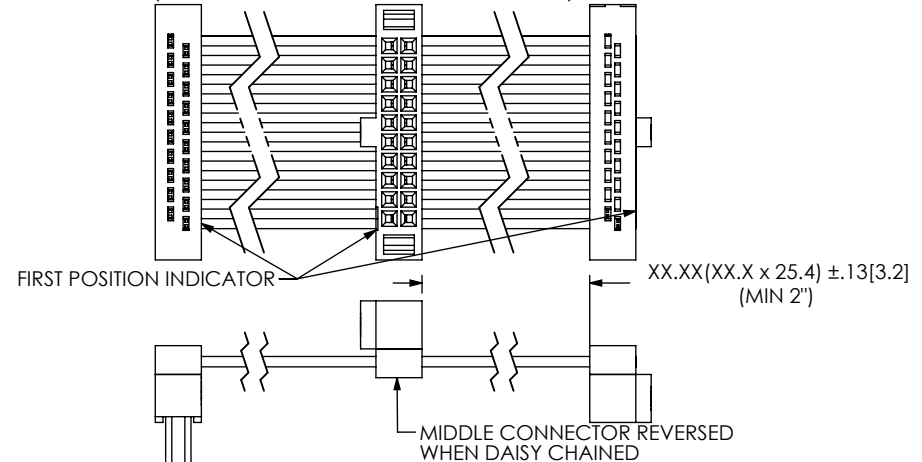

FIG 11

(FFMD-10-T-XX.XX-01-X-N-DXX-M SHOWN)
 (SAME AS FIG 1 AND FIG 6, DIFFERENT AS SHOWN)
 (2.00[50.8] MINIMUM LENGTH, 1.00[25.4] INCREMENTS)
 (NOT AVAILABLE WITH -R OR -O OPTIONS)



PROPRIETARY NOTE

THIS DOCUMENT CONTAINS INFORMATION CONFIDENTIAL AND PROPRIETARY TO SAMTEC, INC. AND SHALL NOT BE REPRODUCED OR TRANSFERRED TO OTHER DOCUMENTS OR DISCLOSED TO OTHERS OR USED FOR ANY PURPOSE OTHER THAN THAT WHICH IT WAS OBTAINED WITHOUT THE EXPRESSED WRITTEN CONSENT OF SAMTEC, INC.

DO NOT SCALE DRAWING

SHEET SCALE: 2:1



520 PARK EAST BLVD, NEW ALBANY, IN 47150
 PHONE: 812-944-6733 FAX: 812-948-5047
 e-Mail: info@SAMTEC.com code: 55322

DESCRIPTION:
 .050 X .050 DOUBLE ROW MALE IDC CABLE ASSEMBLY

DWG. NO.
FFMD-XX-X-XX.XX-01-X-X-XXX

BY: T NEWTON 02/15/2008 SHEET 3 OF 5

FIG 12

(FFMD-10-D-XX.XX-01-DXX-R SHOWN)
 (SAME AS FIG 1, DIFFERENT AS SHOWN)
 (2.00[50.8] MINIMUM LENGTH, 1.00[25.4] INCREMENTS)
 (NOT AVAILABLE WITH -M OR -O OPTIONS)

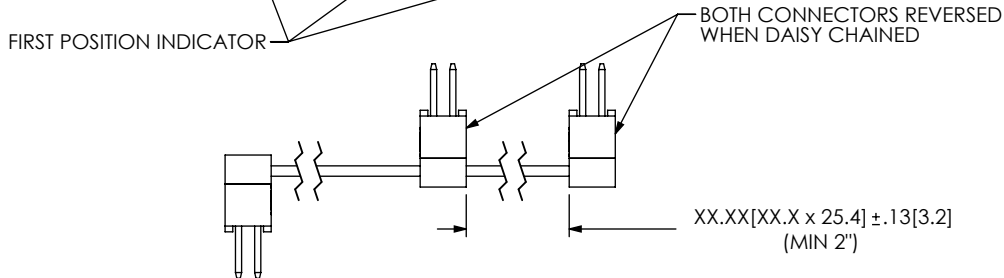
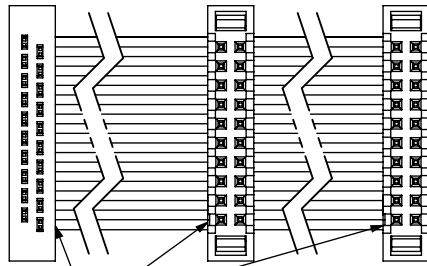

FIG 13

(FFMD-10-D-XX.XX-01-X-DXX)
 (SAME AS FIG 1, DIFFERENT AS SHOWN)
 (2.00[50.8] MINIMUM LENGTH, 1.00[25.4] INCREMENTS)

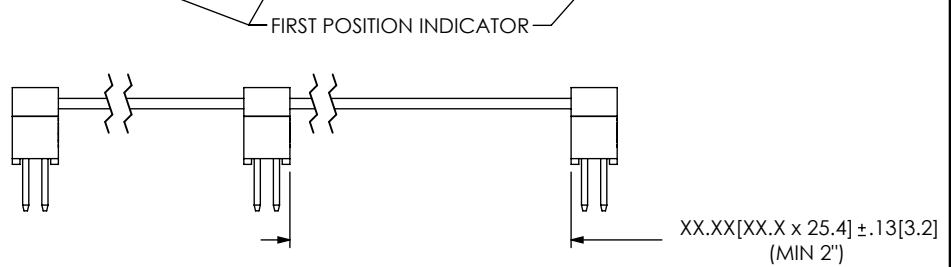
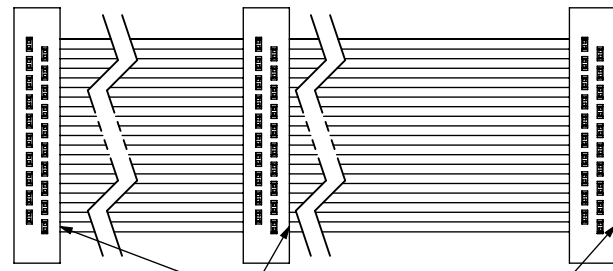

FIG 14

(FFMD-10-T-XX.XX-01-X-N-DXX-R SHOWN)
 (SAME AS FIG 1 AND FIG 6, DIFFERENT AS SHOWN)
 (2.00[50.8] MINIMUM LENGTH, 1.00[25.4] INCREMENTS)
 (NOT AVAILABLE WITH -M OR -O OPTIONS)

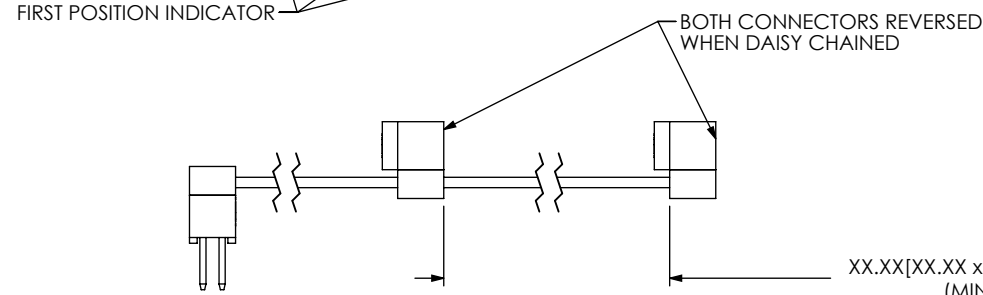
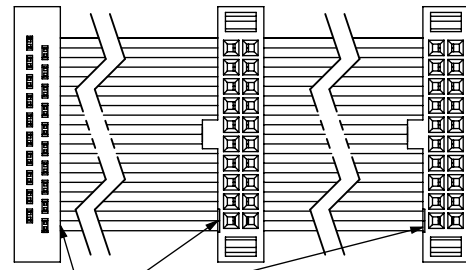
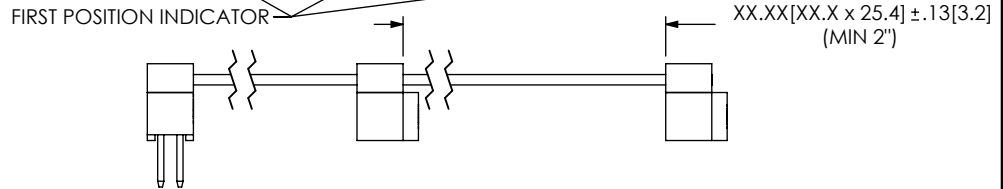
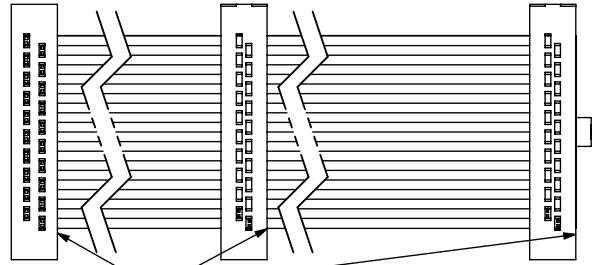

FIG 15

(FFMD-10-T-XX.XX-01-X-N-DXX)
 (SAME AS FIG 1 AND FIG 6, DIFFERENT AS SHOWN)
 (2.00[50.8] MINIMUM LENGTH, 1.00[25.4] INCREMENTS)



PROPRIETARY NOTE

THIS DOCUMENT CONTAINS INFORMATION CONFIDENTIAL AND PROPRIETARY TO SAMTEC, INC. AND SHALL NOT BE REPRODUCED OR TRANSFERRED TO OTHER DOCUMENTS OR DISCLOSED TO OTHERS OR USED FOR ANY PURPOSE OTHER THAN THAT WHICH IT WAS OBTAINED WITHOUT THE EXPRESSED WRITTEN CONSENT OF SAMTEC, INC.

DO NOT SCALE DRAWING

SHEET SCALE: 2:1



520 PARK EAST BLVD, NEW ALBANY, IN 47150
 PHONE: 812-944-6733 FAX: 812-948-5047
 e-Mail: info@SAMTEC.com code: 5332

DESCRIPTION:
 .050 X .050 DOUBLE ROW MALE IDC CABLE ASSEMBLY

DWG. NO.
FFMD-XX-X-XX.XX-01-X-X-XXX

BY: T NEWTON 02/15/2008 SHEET 4 OF 5

FIG 16
 (FFMD-10-T-XX.XX-01-X-N-SR SHOWN)
 (SAME AS FIG 1 AND FIG 3, DIFFERENT AS SHOWN)
 (FOR POSITIONS 2-15 ONLY)

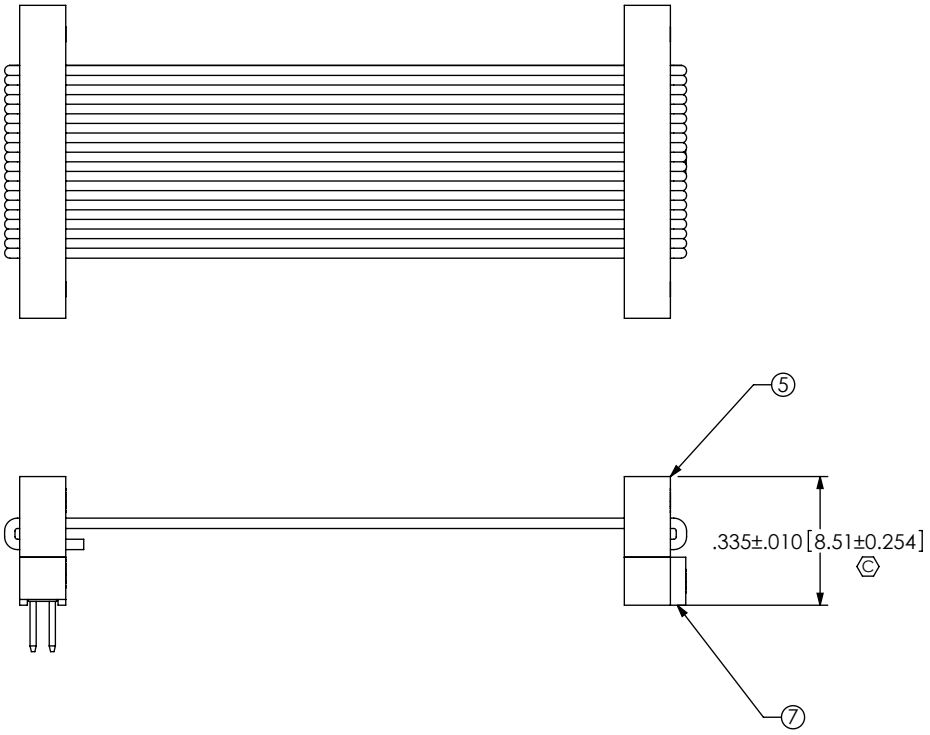
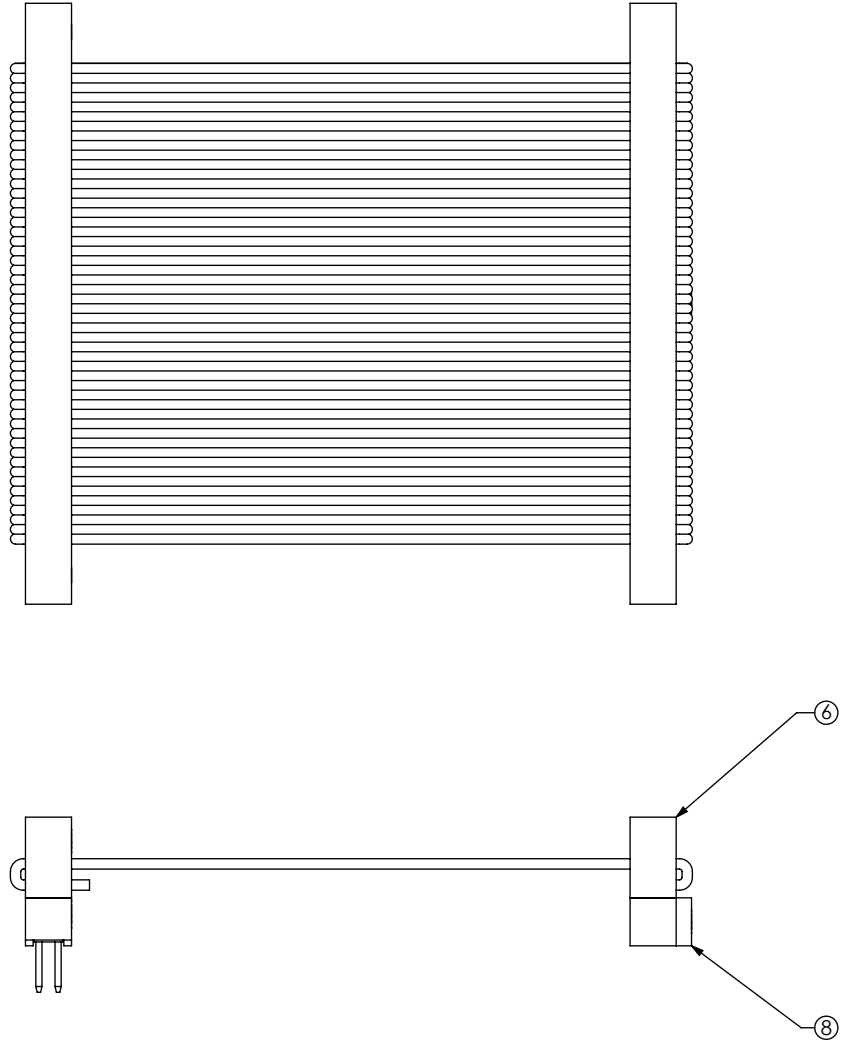



FIG 17
 (FFMD-25-T-XX.XX-01-X-N-SR SHOWN)
 (SAME AS FIG 1 AND FIG 16, DIFFERENT AS SHOWN)
 (FOR POSITIONS 16-25 ONLY)
 *NOT RELEASED FOR PRODUCTION



PROPRIETARY NOTE
 THIS DOCUMENT CONTAINS INFORMATION
 CONFIDENTIAL AND PROPRIETARY TO
 SAMTEC, INC. AND SHALL NOT BE REPRODUCED
 OR TRANSFERRED TO OTHER DOCUMENTS OR
 DISCLOSED TO OTHERS OR USED FOR ANY
 PURPOSE OTHER THAN THAT WHICH IT WAS
 OBTAINED WITHOUT THE EXPRESSED WRITTEN
 CONSENT OF SAMTEC, INC.

DO NOT SCALE DRAWING

SHEET SCALE: 2:1

 520 PARK EAST BLVD, NEW ALBANY, IN 47150 PHONE: 812-944-6733 FAX: 812-948-5047 e-Mail: info@SAMTEC.com code: 55322	
DESCRIPTION: .050 X .050 X DOUBLE ROW MALE IDC CABLE ASSEMBLY	
DWG. NO. FFMD-XX-X-XX.XX-01-X-X-XXX	
BY: T NEWTON 02/15/2008	SHEET 5 OF 5