

EV34C8A3A1-20.480M TR [Click part number to visit Part Number Details page](#)

REGULATORY COMPLIANCE (Data Sheet downloaded on Nov 9, 2017)



◀ Click badges to download compliance docs

Regulatory Compliance standards are subject to updates by governing bodies. Click the badges to download the latest compliance docs for this part number directly from Ecliptek.



ITEM DESCRIPTION

Voltage Controlled Quartz Crystal Clock Oscillators VCXO LVCMOS (CMOS) 2.5Vdc 6 Pad 3.2mm x 5.0mm Ceramic Surface Mount (SMD) 20.480MHz ± 50 ppm Maximum 0°C to +70°C ± 50 ppm Minimum 10% Typical, 20% Maximum

ELECTRICAL SPECIFICATIONS

Nominal Frequency	20.480MHz
Frequency Tolerance/Stability	± 50 ppm Maximum (Inclusive of all conditions: Calibration Tolerance at 25°C, Frequency Stability over the Operating Temperature Range, Supply Voltage Change, Output Load Change, Shock, and Vibration.)
Aging at 25°C	± 2 ppm/First Year Typical, ± 10 ppm/10 Years Maximum
Operating Temperature Range	0°C to +70°C
Supply Voltage	2.5Vdc $\pm 5\%$
Input Current	15mA Maximum
Output Voltage Logic High (Voh)	90% of Vdd Minimum (IOH = -4mA)
Output Voltage Logic Low (Vol)	10% of Vdd Maximum (IOL = +4mA)
Rise/Fall Time	5nSec Maximum (Measured at 20% to 80% of Waveform)
Duty Cycle	50 ± 10 (%) (Measured at 50% of Waveform)
Load Drive Capability	15pF Maximum
Output Logic Type	CMOS
Absolute Pull Range	± 50 ppm Minimum (Inclusive of all conditions: Calibration Tolerance at 25°C, Frequency Stability over the Operating Temperature Range, Supply Voltage Change, Output Load Change, Shock, Vibration, and Aging over the Control Voltage (Vc).)
Control Voltage	0.2Vdc to 2.3Vdc (Test Condition for APR)
Control Voltage Range	0.0Vdc to Vdd
Linearity	10% Typical, 20% Maximum
Transfer Function	Positive Transfer Characteristic
Modulation Bandwidth	10kHz Minimum (Measured at -3dB, Vc = 1.25Vdc)
Input Impedance	50kOhms Minimum
Input Leakage Current	10 μ A Maximum
Phase Noise	All Values are Typical -65dBc/Hz at offset of 10Hz -95dBc/Hz at offset of 100Hz -120dBc/Hz at offset of 1kHz -142dBc/Hz at offset of 10kHz -152dBc/Hz at offset of 100kHz -154dBc/Hz at offset of 1MHz
Tri-State Input Voltage (Vih and Vil)	90% of Vdd Minimum or No Connect to Enable Output, 10% of Vdd Maximum to Disable Output (High Impedance)
RMS Phase Jitter	1pSec Maximum (Fj = 12kHz to 20MHz; Random)
Start Up Time	10mSec Maximum
Storage Temperature Range	-55°C to +125°C

ENVIRONMENTAL & MECHANICAL SPECIFICATIONS

ESD Susceptibility	MIL-STD-883, Method 3015, Class 1, HBM: 1500V
Fine Leak Test	MIL-STD-883, Method 1014, Condition A
Flammability	UL94-V0
Gross Leak Test	MIL-STD-883, Method 1014, Condition C
Mechanical Shock	MIL-STD-883, Method 2002, Condition B

EV34C8A3A1-20.480M TR [Click part number to visit Part Number Details page](#)**ENVIRONMENTAL & MECHANICAL SPECIFICATIONS CONTINUED**

Moisture Resistance	MIL-STD-883, Method 1004
Moisture Sensitivity	J-STD-020, MSL 1
Resistance to Soldering Heat	MIL-STD-202, Method 210, Condition K
Resistance to Solvents	MIL-STD-202, Method 215
Solderability	MIL-STD-883, Method 2003
Temperature Cycling	MIL-STD-883, Method 1010, Condition B
Vibration	MIL-STD-883, Method 2007, Condition A

EV34C8A3A1-20.480M TR [Click part number to visit Part Number Details page](#)

MECHANICAL DIMENSIONS (all dimensions in millimeters)

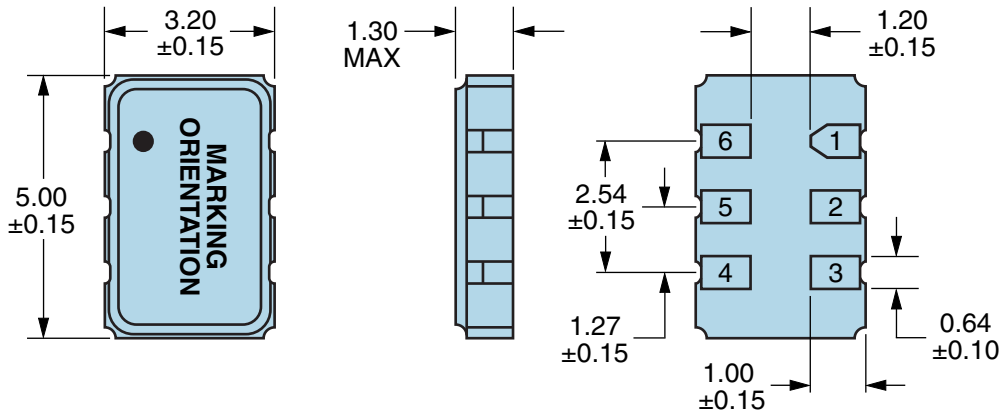

PIN	CONNECTION
1	Control Voltage
2	Tri-State
3	Case/Ground
4	Output
5	No Connect
6	Supply Voltage

LINE	MARKING
1	E20.480 <i>E=Ecliptek Designator</i>
2	XXXXX <i>XXXXX=Ecliptek Manufacturing Identifier</i>

Suggested Solder Pad Layout

All Dimensions in Millimeters



All Tolerances are ± 0.1

EV34C8A3A1-20.480M TR [Click part number to visit Part Number Details page](#)

OUTPUT WAVEFORM & TIMING DIAGRAM

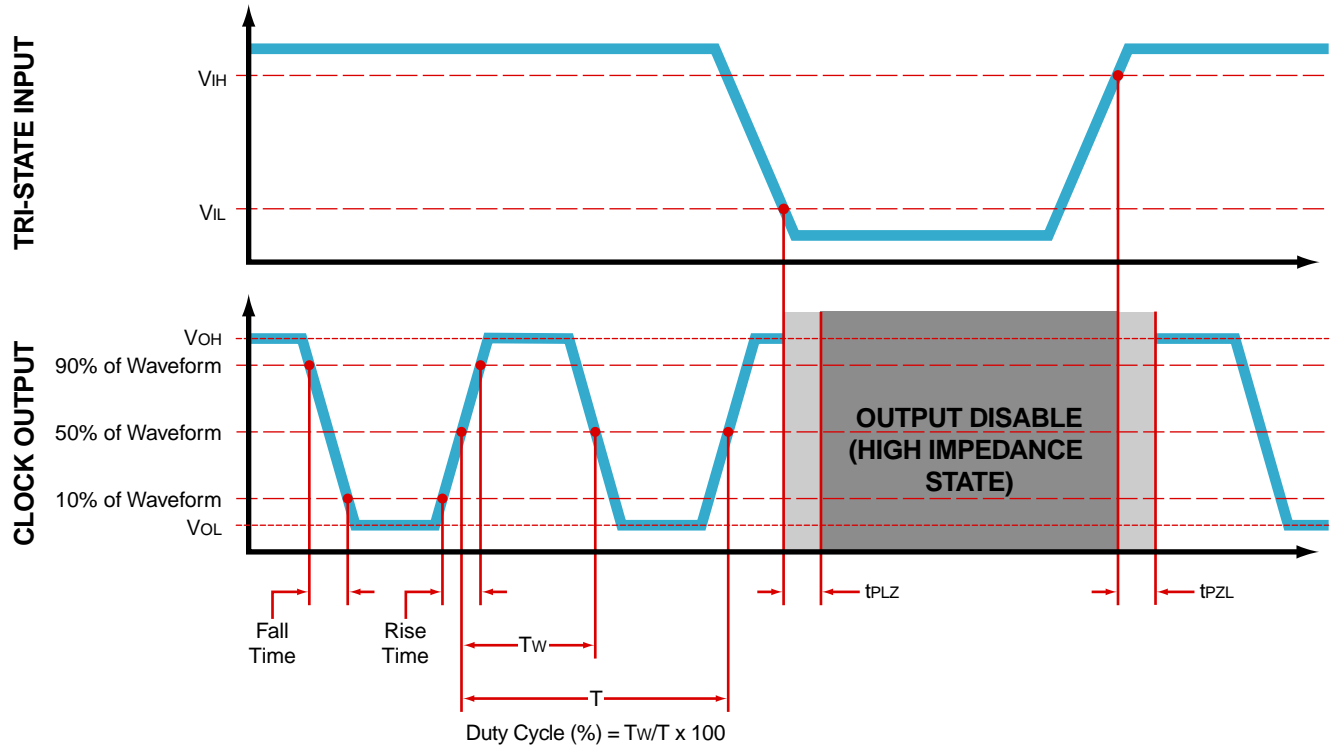

EV34C8A3A1-20.480M TR [Click part number to visit Part Number Details page](#)

Test Circuit for CMOS Output

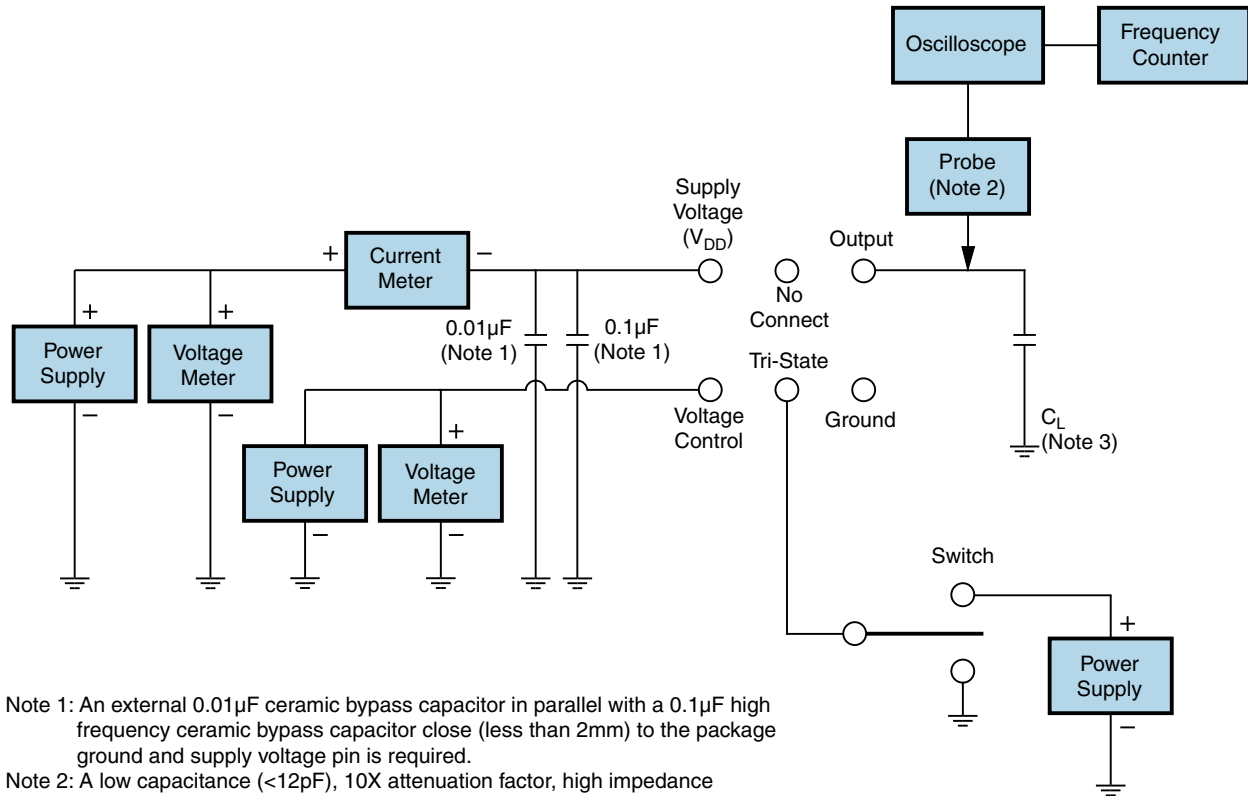

Note 1: An external $0.01\mu\text{F}$ ceramic bypass capacitor in parallel with a $0.1\mu\text{F}$ high frequency ceramic bypass capacitor close (less than 2mm) to the package ground and supply voltage pin is required.

Note 2: A low capacitance ($<12\text{pF}$), 10X attenuation factor, high impedance ($>10\text{Mohms}$), and high bandwidth ($>300\text{MHz}$) passive probe is recommended.

Note 3: Capacitance value C_L includes sum of all probe and fixture capacitance.

EV34C8A3A1-20.480M TR

Tape & Reel Dimensions

Quantity Per Reel: 1,000 units

All Dimensions in Millimeters

Compliant to EIA-481

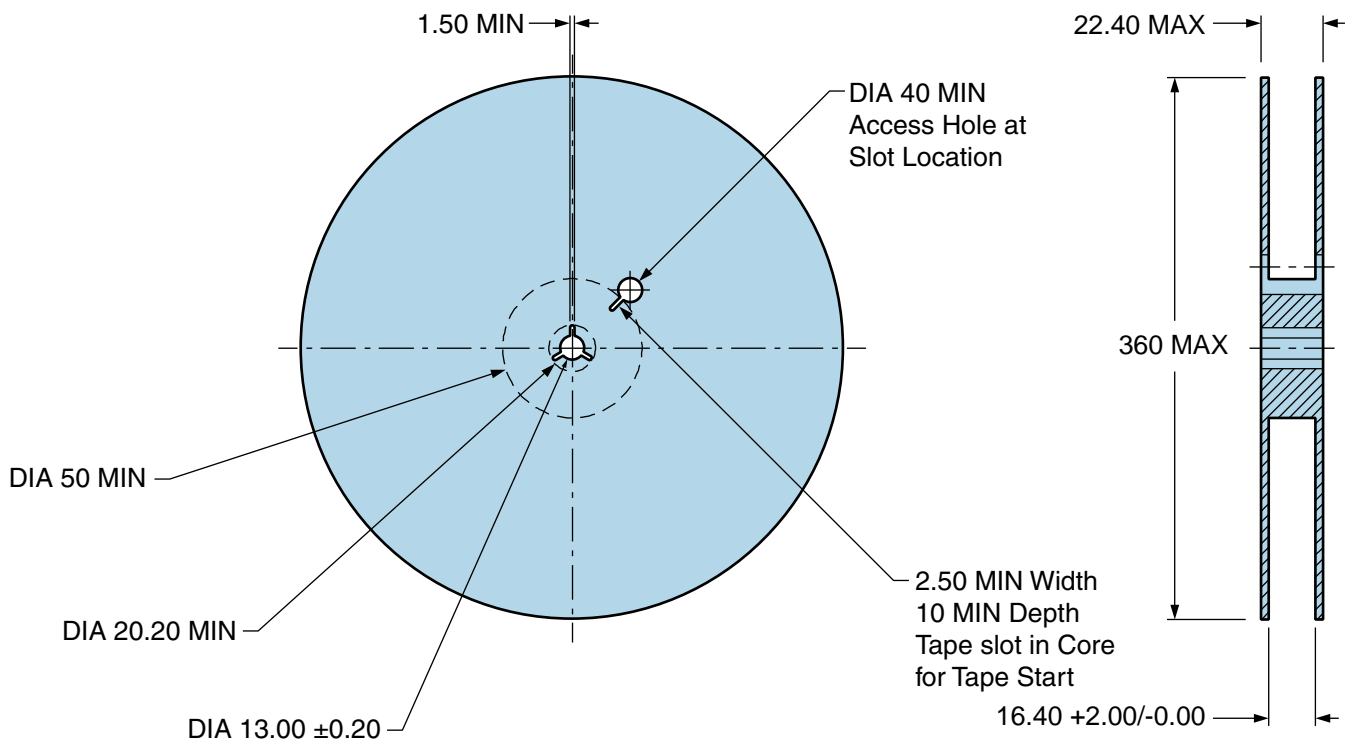
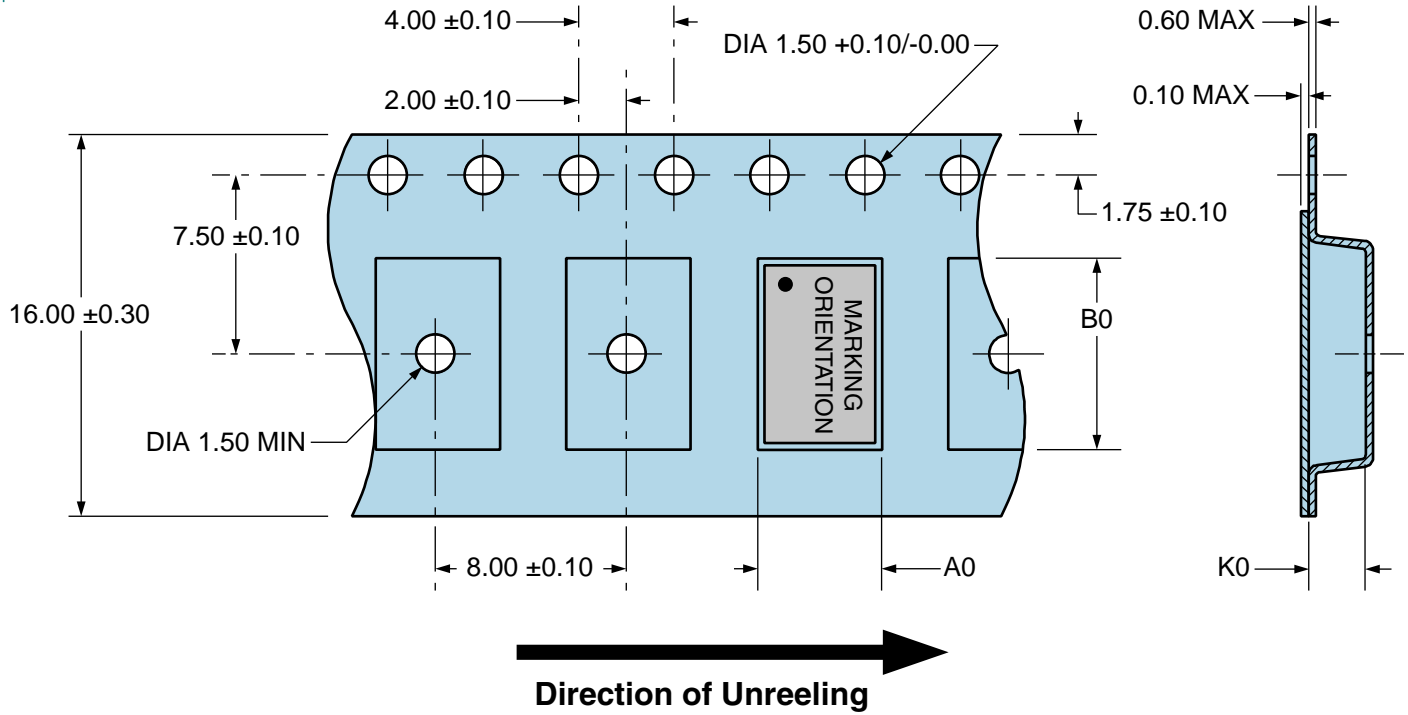

EV34C8A3A1-20.480M TR [Click part number to visit Part Number Details page](#)

Recommended Solder Reflow Methods



High Temperature Infrared/Convection

T_S MAX to T_L (Ramp-up Rate)	3°C/Second Maximum
Preheat	
- Temperature Minimum (T_S MIN)	150°C
- Temperature Typical (T_S TYP)	175°C
- Temperature Maximum (T_S MAX)	200°C
- Time (t_s MIN)	60 - 180 Seconds
Ramp-up Rate (T_L to T_P)	3°C/Second Maximum
Time Maintained Above:	
- Temperature (T_L)	217°C
- Time (t_L)	60 - 150 Seconds
Peak Temperature (T_P)	260°C Maximum for 10 Seconds Maximum
Target Peak Temperature (T_P Target)	250°C +0/-5°C
Time within 5°C of actual peak (t_p)	20 - 40 Seconds
Ramp-down Rate	6°C/Second Maximum
Time 25°C to Peak Temperature (t)	8 Minutes Maximum
Moisture Sensitivity Level	Level 1

EV34C8A3A1-20.480M TR [Click part number to visit Part Number Details page](#)

Recommended Solder Reflow Methods

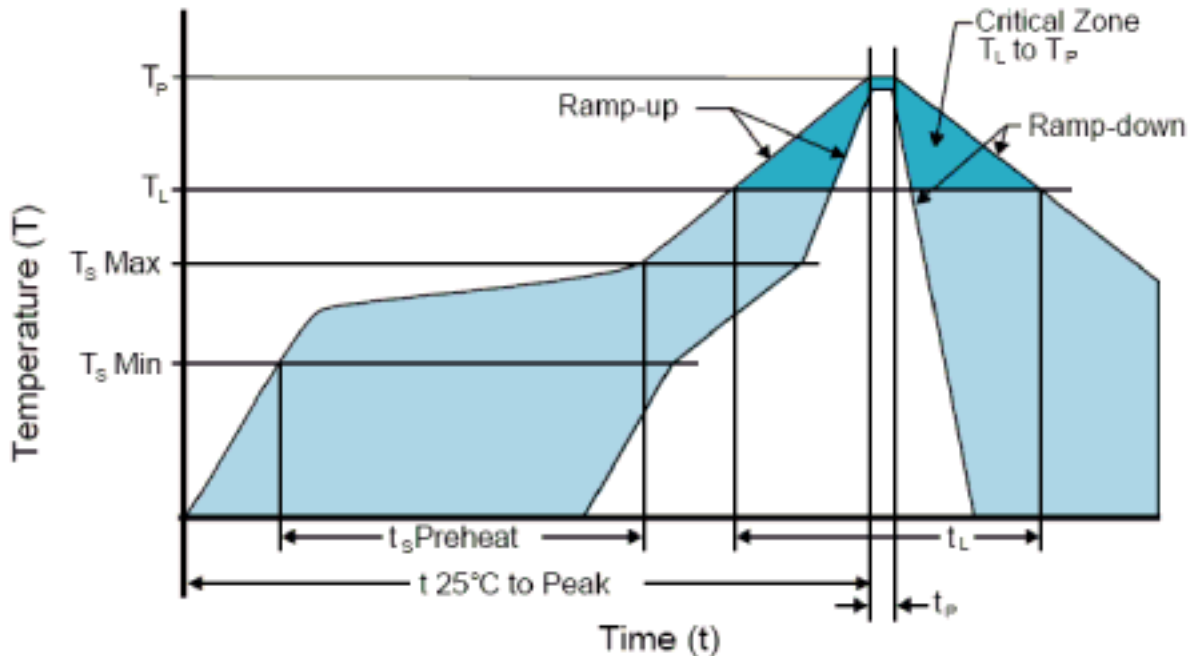

Low Temperature Infrared/Convection 240°C

Ts MAX to Tl (Ramp-up Rate) 5°C/Second Maximum

Preheat

- Temperature Minimum (Ts MIN) N/A
 - Temperature Typical (Ts TYP) 150°C
 - Temperature Maximum (Ts MAX) N/A
 - Time (ts MIN) 60 - 120 Seconds

Ramp-up Rate (Tl to Tp) 5°C/Second Maximum

Time Maintained Above:

- Temperature (Tl) 150°C
 - Time (tL) 200 Seconds Maximum

Peak Temperature (Tp) 240°C Maximum

Target Peak Temperature (Tp Target) 240°C Maximum 2 Times / 230°C Maximum 1 Time

Time within 5°C of actual peak (tp) 10 Seconds Maximum 2 Times / 80 Seconds Maximum 1 Time

Ramp-down Rate 5°C/Second Maximum

Time 25°C to Peak Temperature (t) N/A

Moisture Sensitivity Level Level 1

Low Temperature Manual Soldering

185°C Maximum for 10 Seconds Maximum, 2 times Maximum.

High Temperature Manual Soldering

260°C Maximum for 5 Seconds Maximum, 2 times Maximum.