

RF Transistor, NPN Single

12 V, 150 mA, $f_T = 7$ GHz

NSVF6003SB6

Description

This RF Transistor is designed for low noise amplifier applications. CPH package is suitable for use under high temperature environment because it has superior heat radiation characteristics. This RF transistor is AEC-Q101 qualified and PPAP capable for automotive applications.

Features

- High Gain ($f_T = 7$ GHz typ)
- High Current ($I_C = 150$ mA)
- Miniature and Thin 6 pin Package
- Large Collector Dissipation (800 mW)
- AEC-Q101 Qualified and PPAP Capable
- These Devices are Pb-Free and are RoHS Compliant

Typical Applications

- Low Noise Amplifier for FM Radio
- Low Noise Amplifier for TV

SPECIFICATIONS

ABSOLUTE MAXIMUM RATINGS ($T_A = 25^\circ\text{C}$)

Symbol	Parameter	Value	Unit
V_{CBO}	Collector-to-Base Voltage	20	V
V_{CEO}	Collector-to-Emitter Voltage	12	V
V_{EBO}	Emitter-to-Base Voltage	2	V
I_C	Collector Current	150	mA
P_C	Collector Dissipation (Note 1)	800	mW
T_j, T_{stg}	Operating Junction and Storage Temperature	-55 to +150	$^\circ\text{C}$

Stresses exceeding those listed in the Maximum Ratings table may damage the device. If any of these limits are exceeded, device functionality should not be assumed, damage may occur and reliability may be affected.

1. Surface mounted on ceramic substrate (250 mm² x 0.8 mm).

12 V, 150 mA
 $f_T = 7$ GHz typ.
 RF Transistor

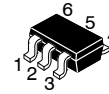

CPH6
 CASE 318BD

ELECTRICAL CONNECTION NPN

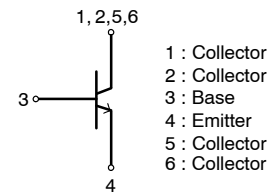

MARKING DIAGRAM

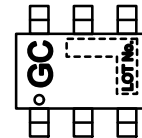

ORDERING INFORMATION

Device	Package	Shipping [†]
NSVF6003SB6T1G	CPH6 (Pb-Free, Halogen Free)	3000 / Tape & Reel

[†]For information on tape and reel specifications, including part orientation and tape sizes, please refer to our Tape and Reel Packaging Specifications Brochure, [BRD8011/D](#).

NSVF6003SB6

ELECTRICAL CHARACTERISTICS ($T_A = 25^\circ\text{C}$) (Note 3)

Symbol	Parameter	Conditions	Value			Unit
			Min	Typ	Max	
I_{CBO}	Collector Cutoff Current	$V_{CB} = 10\text{ V}, I_E = 0\text{ A}$	–	–	1.0	μA
I_{EBO}	Emitter Cutoff Current	$V_{EB} = 1\text{ V}, I_C = 0\text{ A}$	–	–	10	μA
h_{FE}	DC Current Gain	$V_{CE} = 5\text{ V}, I_C = 50\text{ mA}$	100	–	180	–
f_T	Gain–Bandwidth Product		–	7	–	GHz
C_{ob}	Output Capacitance	$V_{CB} = 10\text{ V}, f = 1\text{ MHz}$	–	1.3	2.0	pF
C_{re}	Reverse Transfer Capacitance		–	0.9	–	pF
$ S_{21e} ^2$	Forward Transfer Gain	$V_{CE} = 5\text{ V}, I_C = 50\text{ mA}, f = 1\text{ GHz}$	–	9.0	–	dB
NF	Noise Figure	$V_{CE} = 5\text{ V}, I_C = 5.0\text{ mA}, f = 1\text{ GHz}$	–	1.8	3.0	dB

Product parametric performance is indicated in the Electrical Characteristics for the listed test conditions, unless otherwise noted. Product performance may not be indicated by the Electrical Characteristics if operated under different conditions.

2. Pay attention to handling since it is liable to be affected by static electricity due to the high-frequency process adopted.

NSVF6003SB6

TYPICAL CHARACTERISTICS

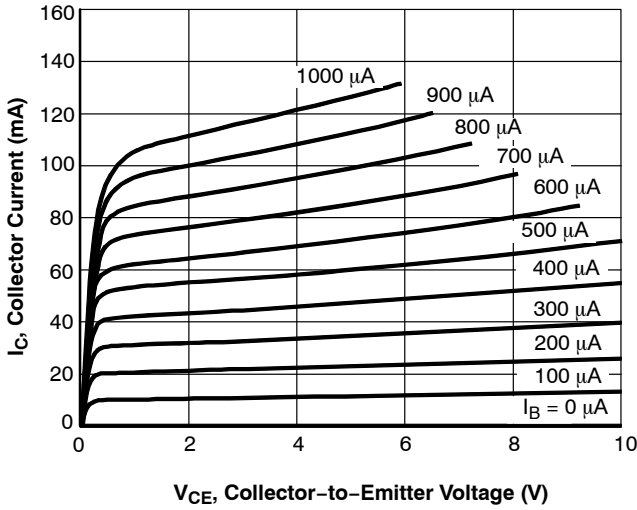

Figure 1. $I_C - V_{CE}$

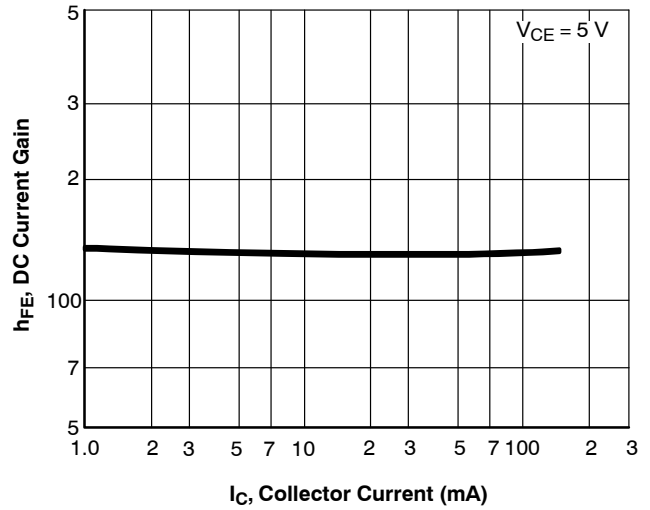

Figure 2. $h_{FE} - I_C$

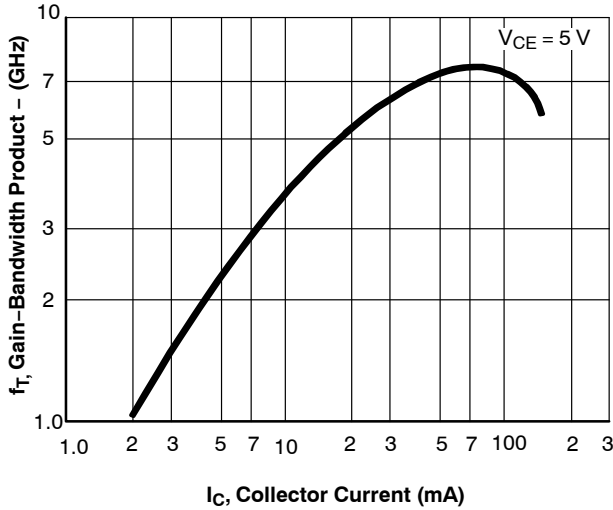

Figure 3. $f_T - I_C$

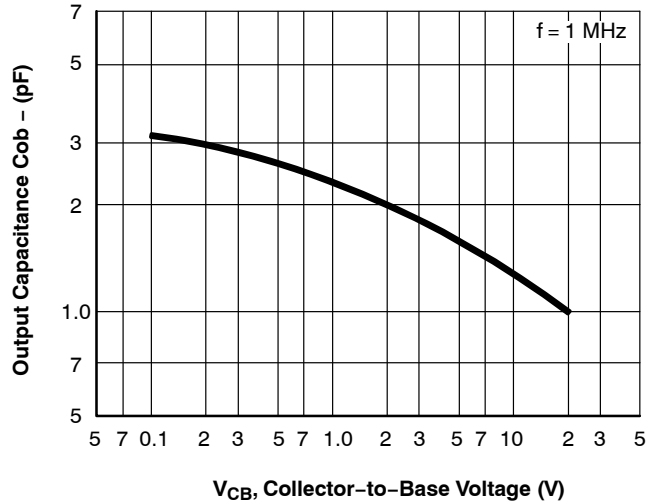

Figure 4. $C_{ob} - V_{CB}$

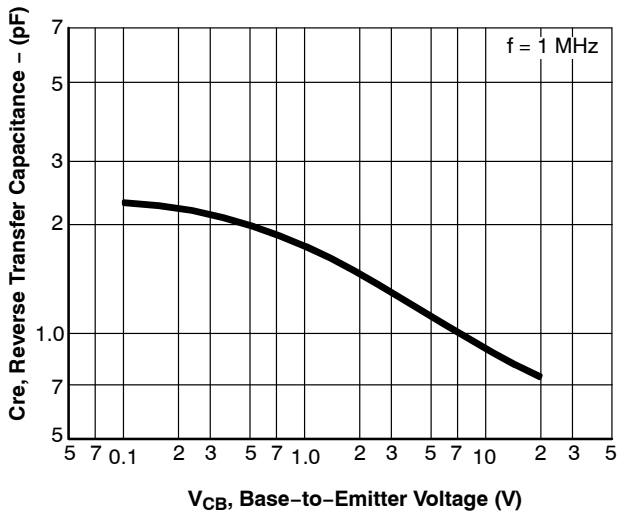

Figure 5. $C_{re} - V_{CB}$

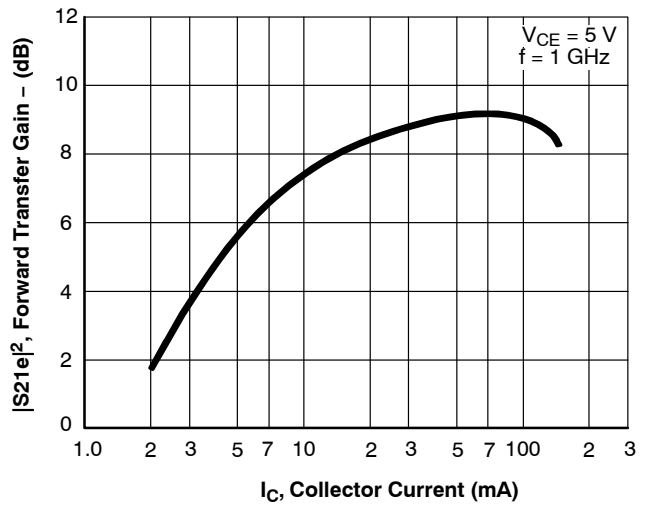

Figure 6. $|S_{21e}|^2 - I_C$

NSVF6003SB6

TYPICAL CHARACTERISTICS (CONTINUED)

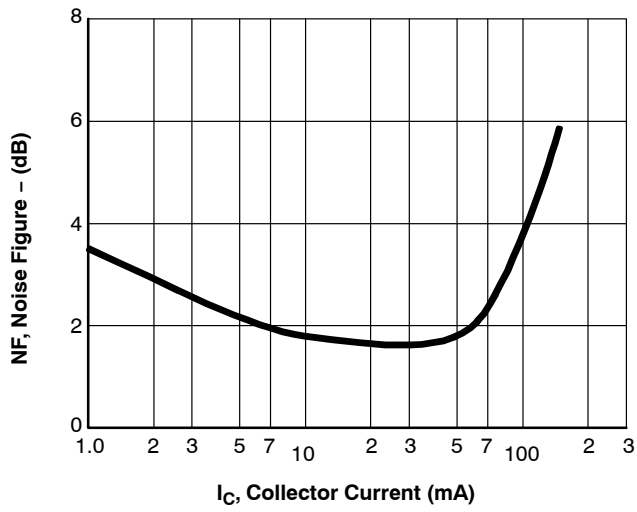

Figure 7. NF - I_C

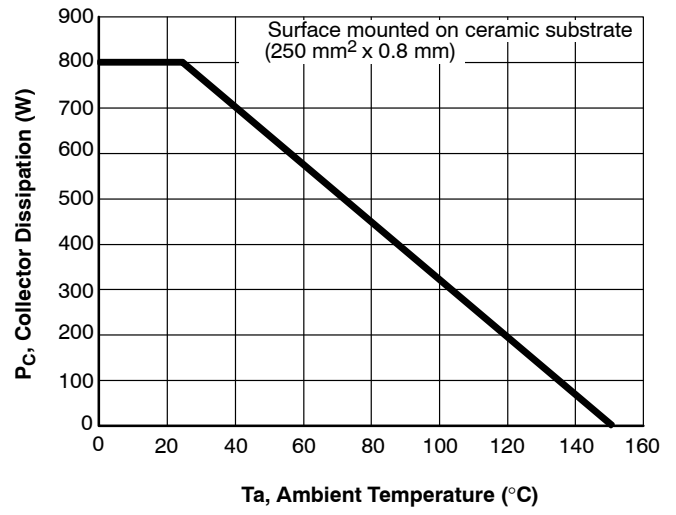

Figure 8. P_C - T_a

NSVF6003SB6

S Parameters (Common emitter)

$V_{CE} = 5\text{ V}$, $I_C = 20\text{ mA}$, $Z_O = 50\ \Omega$

Freq(MHz)	S ₁₁	∠S ₁₁	S ₂₁	∠S ₂₁	S ₁₂	∠S ₁₂	S ₂₂	∠S ₂₂
100	0.550	254.1	21.532	119.9	0.036	54.6	0.527	-62.8
200	0.492	218.1	12.273	103.0	0.050	56.5	0.332	-80.3
300	0.477	201.9	8.448	95.3	0.063	61.7	0.267	-88.3
400	0.470	192.4	6.427	90.4	0.078	65.3	0.242	268.1
500	0.518	181.0	5.015	86.8	0.089	68.2	0.217	245.3
600	0.513	175.8	4.221	83.9	0.104	70.2	0.216	245.8
700	0.510	171.5	3.658	81.3	0.120	71.7	0.214	247.2
800	0.508	167.6	3.234	78.9	0.135	72.7	0.220	249.3
900	0.503	163.7	2.900	76.7	0.150	73.2	0.225	251.3
1000	0.497	160.1	2.636	74.4	0.166	73.7	0.231	254.6
1100	0.493	156.8	2.419	72.5	0.181	73.9	0.239	256.3
1200	0.489	153.4	2.243	70.5	0.196	74.1	0.247	258.8

$V_{CE} = 5\text{ V}$, $I_C = 50\text{ mA}$, $Z_O = 50\ \Omega$

Freq(MHz)	S ₁₁	∠S ₁₁	S ₂₁	∠S ₂₁	S ₁₂	∠S ₁₂	S ₂₂	∠S ₂₂
100	0.465	231.1	25.203	111.9	0.029	59.2	0.413	-79.9
200	0.449	203.4	13.519	98.7	0.045	65.7	0.269	259.6
300	0.445	191.6	9.177	92.7	0.061	70.4	0.230	250.7
400	0.443	184.2	6.947	88.8	0.078	72.8	0.218	247.3
500	0.502	175.0	5.407	86.1	0.092	74.7	0.231	224.3
600	0.497	170.3	4.550	83.7	0.110	75.6	0.229	225.5
700	0.494	166.4	3.944	81.5	0.127	76.2	0.225	227.1
800	0.490	162.8	3.483	79.4	0.144	76.4	0.228	229.9
900	0.485	159.1	3.127	77.4	0.161	76.2	0.230	232.4
1000	0.478	155.5	2.845	75.5	0.178	76.1	0.230	236.1
1100	0.473	152.3	2.608	73.6	0.195	75.9	0.236	238.6
1200	0.468	149.0	2.423	71.9	0.211	75.5	0.239	242.0

$V_{CE} = 5\text{ V}$, $I_C = 100\text{ mA}$, $Z_O = 50\ \Omega$

Freq(MHz)	S ₁₁	∠S ₁₁	S ₂₁	∠S ₂₁	S ₁₂	∠S ₁₂	S ₂₂	∠S ₂₂
100	0.451	219.5	25.808	108.5	0.026	62.4	0.359	-86.7
200	0.448	196.7	13.593	96.8	0.043	69.8	0.240	253.1
300	0.448	187.0	9.193	91.4	0.060	73.8	0.212	244.9
400	0.446	180.7	6.953	87.8	0.078	75.5	0.205	242.3
500	0.508	172.6	5.408	85.5	0.093	76.9	0.228	219.9
600	0.503	168.3	4.550	83.1	0.110	77.5	0.226	221.5
700	0.500	164.6	3.944	81.0	0.128	77.8	0.223	223.4
800	0.497	161.2	3.480	79.0	0.145	77.8	0.226	226.5
900	0.490	157.6	3.132	77.0	0.163	77.4	0.228	229.1
1000	0.484	154.2	2.842	75.0	0.180	77.1	0.227	233.1
1100	0.479	151.0	2.614	73.3	0.197	76.7	0.232	235.8
1200	0.473	147.8	2.423	71.6	0.214	76.3	0.236	239.3

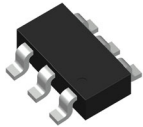

CPH6 2.90x1.60x0.90, 0.95P
CASE 318BD
ISSUE A

DATE 20 SEPT 2024

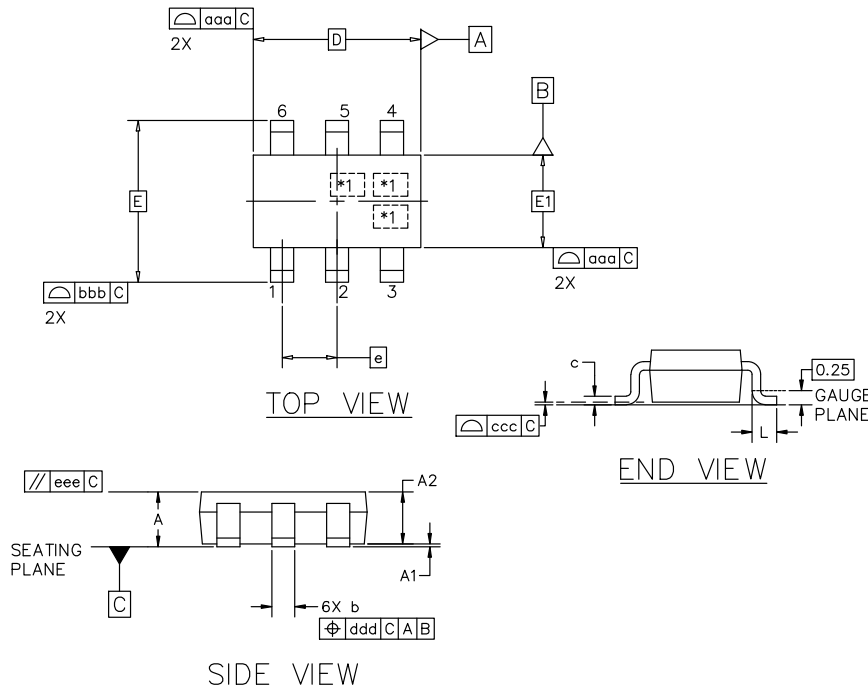

MILLIMETERS			
DIM	MIN	NOM	MAX
A	0.85	0.95	1.05
A1	0.00	0.05	0.10
A2	0.85	0.90	0.95
b	0.30	0.40	0.50
c	0.10	0.15	0.25
D	2.90 BSC		
E	2.80 BSC		
E1	1.60 BSC		
e	0.95 BSC		
L	0.10	0.20	0.30
TOLERANCE FORM AND POSITION			
aaa	0.10		
bbb	0.15		
ccc	0.05		
ddd	0.10		
eee	0.10		

NOTES:

1. DIMENSIONING AND TOLERANCING PER ASME Y14.5M, 2018.
2. CONTROLLING DIMENSION: MILLIMETERS
3. *1 IS FOR LOT INDICATION

GENERIC MARKING DIAGRAM*

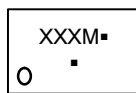

- XXX = Specific Device Code
- M = Date Code
- = Pb-Free Package

(Note: Microdot may be in either location)

*This information is generic. Please refer to device data sheet for actual part marking. Pb-Free indicator, "G" or microdot "▪", may or may not be present. Some products may not follow the Generic Marking.

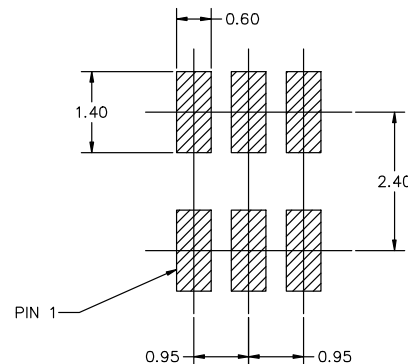

RECOMMENDED MOUNTING FOOTPRINT

* For additional information on our Pb-Free strategy and soldering details, please download the onsemi Soldering and Mounting Techniques Reference Manual, SOLDERRM/D.

DOCUMENT NUMBER:	98AON65440E	Electronic versions are uncontrolled except when accessed directly from the Document Repository. Printed versions are uncontrolled except when stamped "CONTROLLED COPY" in red.
DESCRIPTION:	CPH6 2.90x1.60x0.90, 0.95P	PAGE 1 OF 1

onsemi and ONSEMI are trademarks of Semiconductor Components Industries, LLC dba onsemi or its subsidiaries in the United States and/or other countries. onsemi reserves the right to make changes without further notice to any products herein. onsemi makes no warranty, representation or guarantee regarding the suitability of its products for any particular purpose, nor does onsemi assume any liability arising out of the application or use of any product or circuit, and specifically disclaims any and all liability, including without limitation special, consequential or incidental damages. onsemi does not convey any license under its patent rights nor the rights of others.

onsemi, **Onsemi**, and other names, marks, and brands are registered and/or common law trademarks of Semiconductor Components Industries, LLC dba "**onsemi**" or its affiliates and/or subsidiaries in the United States and/or other countries. **onsemi** owns the rights to a number of patents, trademarks, copyrights, trade secrets, and other intellectual property. A listing of **onsemi**'s product/patent coverage may be accessed at www.onsemi.com/site/pdf/Patent-Marking.pdf. **onsemi** reserves the right to make changes at any time to any products or information herein, without notice. The information herein is provided "as-is" and **onsemi** makes no warranty, representation or guarantee regarding the accuracy of the information, product features, availability, functionality, or suitability of its products for any particular purpose, nor does **onsemi** assume any liability arising out of the application or use of any product or circuit, and specifically disclaims any and all liability, including without limitation special, consequential or incidental damages. Buyer is responsible for its products and applications using **onsemi** products, including compliance with all laws, regulations and safety requirements or standards, regardless of any support or applications information provided by **onsemi**. "Typical" parameters which may be provided in **onsemi** data sheets and/or specifications can and do vary in different applications and actual performance may vary over time. All operating parameters, including "Typicals" must be validated for each customer application by customer's technical experts. **onsemi** does not convey any license under any of its intellectual property rights nor the rights of others. **onsemi** products are not designed, intended, or authorized for use as a critical component in life support systems or any FDA Class 3 medical devices or medical devices with a same or similar classification in a foreign jurisdiction or any devices intended for implantation in the human body. Should Buyer purchase or use **onsemi** products for any such unintended or unauthorized application, Buyer shall indemnify and hold **onsemi** and its officers, employees, subsidiaries, affiliates, and distributors harmless against all claims, costs, damages, and expenses, and reasonable attorney fees arising out of, directly or indirectly, any claim of personal injury or death associated with such unintended or unauthorized use, even if such claim alleges that **onsemi** was negligent regarding the design or manufacture of the part. **onsemi** is an Equal Opportunity/Affirmative Action Employer. This literature is subject to all applicable copyright laws and is not for resale in any manner.

ADDITIONAL INFORMATION

TECHNICAL PUBLICATIONS:

Technical Library: www.onsemi.com/design/resources/technical-documentation
onsemi Website: www.onsemi.com

ONLINE SUPPORT: www.onsemi.com/support

For additional information, please contact your local Sales Representative at www.onsemi.com/support/sales