



**ELECTRONIC
INNOVATIONS
IN ACTION**
SEMICONDUCTORS

High Speed Fast Recovery Rectifier

145.73 11/77

A398

1500 Volts 400A Avg.

The A398 series is General Electric's highly reliable, all-diffused, Press-Pak, 400 ampere, fast recovery, silicon rectifier diode. These diodes are designed for use in high frequency applications or where a fast recovery diode is a necessity. These diodes provide a superior combination of speed, blocking voltage capability and soft recovery, which is required in such demanding applications as:

- Inverter Feedback Diode
- Free Wheeling Diode
- High Frequency Rectification
- Low EMI Power Supplies

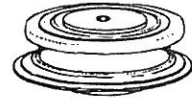

FEATURES:

- +175°C Operating Junction Temperature
- Published Current Ratings Up to 20,000 Hz
- Soft Recovery With Low Recovery Charge
- All-Diffused
- Package Reversibility
- Rugged Glazed Ceramic Hermetic Package

MAXIMUM ALLOWABLE RATINGS AND SPECIFICATIONS

TYPES	REPETITIVE ¹ PEAK REVERSE VOLTAGE, V_{RRM} $T_J = -40^\circ\text{C to } +175^\circ\text{C}$	NON-REPETITIVE ² PEAK REVERSE VOLTAGE, V_{RSM} $T_J = 25^\circ\text{C to } 175^\circ\text{C}$	DC REVERSE ³ VOLTAGE, V_R $T_J = -40^\circ\text{C to } +175^\circ\text{C}$	REPETITIVE PEAK REVERSE CURRENT, I_{RRM} $T_J = 175^\circ\text{C}$
A398A	100 Volts	200 Volts	100 Volts	25 mA
A398B	200	300	200	25
A398C	300	400	300	25
A398D	400	500	400	25
A398E	500	600	500	25
A398M	600	720	600	25
A398S	700	840	700	25
A398N	800	950	800	25
A398T	900	1075	900	25
A398P	1000	1200	1000	25
A398PA	1100	1300	1100	25
A398PB	1200	1400	1200	25
A398PC	1300	1520	1300	25
A398PD	1400	1600	1400	25
A398PE	1500	1700	1500	25

Peak Forward Current, I_{FM} ($T_C = +90^\circ\text{C}$, Half Sine Wave Pulse Width = 8.3 msec., D.F. = 50%) 1200 Amperes
 Forward Voltage Drop, V_{FM} ($I_F = 3000 \text{ A.}$, $T_J = +25^\circ\text{C}$) 2.8 Volts
 Reverse Recovery Charge, Q_{RR} ($I_T = 1260 \text{ A}$, $di/dt = 25 \text{ A}/\mu\text{sec}$, $T_J = 25^\circ\text{C}$) 42 μc Maximum
 - Type A398-X9 26 μc Maximum
 Peak One-Cycle Surge (Non-Repetitive), Forward Current, I_{FSM} (60 Hz) 7000 Amperes
 Minimum I^2t Rating (See Curve 11), $t \geq 1.8 \text{ msec.}$ (Non-Repetitive) 167,000 (RMS Ampere)² Seconds
 Thermal Resistance, $R_{\theta JC}$ (DC)095°C/Watt
 Storage Temperature, T_{SIG} -40°C to +175°C
 Operating Junction Temperature, T_J -40°C to +175°C
 Mounting Force Required 800 Lbs. \pm 10%
 3.56 KN \pm 10%

NOTES:

- ¹ Assumes a heatsink thermal resistance of less than 2.0°C/watt.
- ² Non-repetitive voltage and current ratings, as contrasted to repetitive ratings, apply for occasional or unpredictable overloads. For example, the forward surge current ratings are non-repetitive ratings that are used in fault coordination work.
- ³ Assumes a heatsink thermal resistance of less than 1.0°C/watt.

DEVICE SPECIFICATIONS

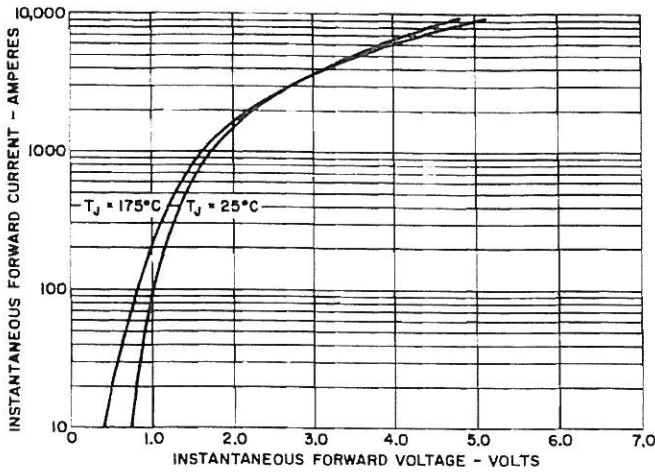

1. MAXIMUM FORWARD CHARACTERISTICS

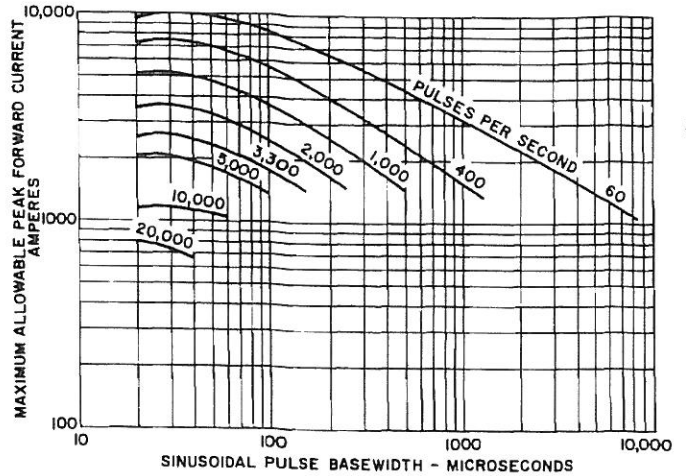

2. MAXIMUM ALLOWABLE PEAK FORWARD CURRENT SINUSOIDAL WAVEFORM ($T_c = 95^\circ\text{C}$) DOUBLE-SIDE COOLED

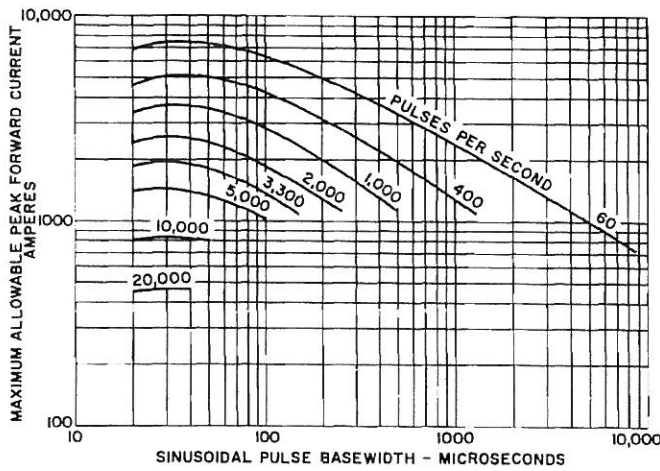

3. MAXIMUM ALLOWABLE FORWARD CURRENT SINUSOIDAL WAVEFORM ($T_c = 120^\circ\text{C}$) DOUBLE-SIDE COOLED

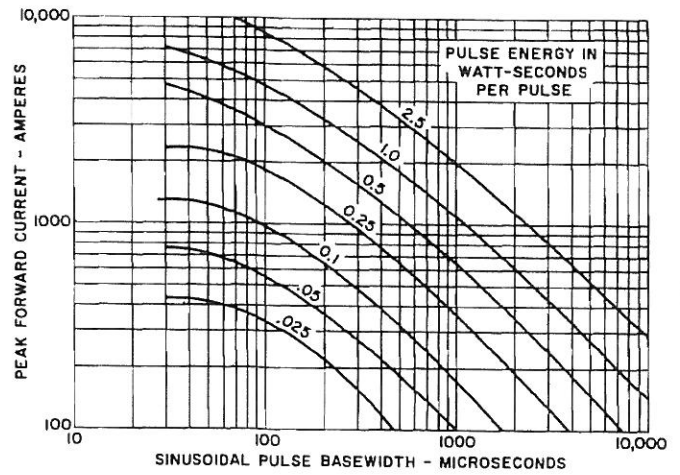

4. SINUSOIDAL PULSE ENERGY ($T_j = 175^\circ\text{C}$)

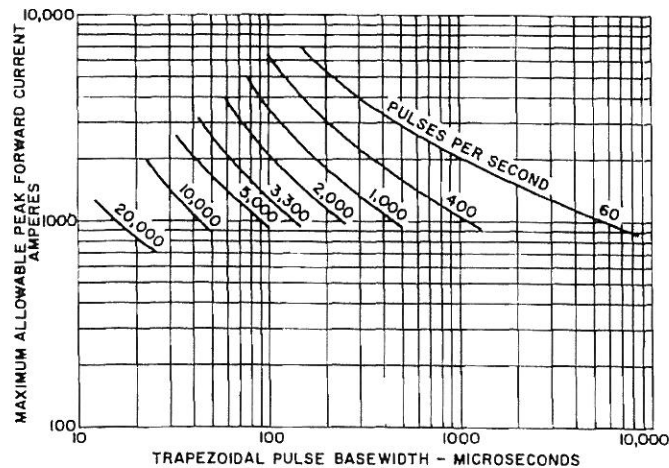

5. MAXIMUM ALLOWABLE PEAK FORWARD CURRENT TRAPEZOIDAL WAVEFORM ($T_c = 95^\circ\text{C}$) DI/DT (RISING & FALLING) = $100 \text{ A}/\mu\text{s}$ DOUBLE-SIDE COOLED

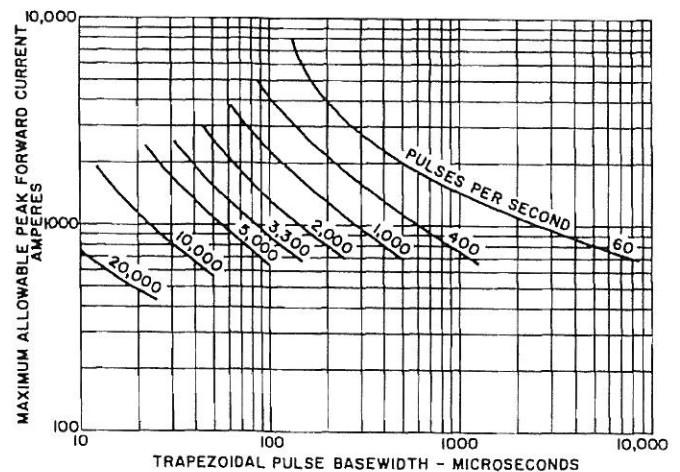

6. MAXIMUM ALLOWABLE PEAK FORWARD CURRENT TRAPEZOIDAL WAVEFORM ($T_c = 120^\circ\text{C}$) DI/DT (RISING & FALLING) = $100 \text{ A}/\mu\text{s}$ DOUBLE-SIDE COOLED

DEVICE SPECIFICATIONS

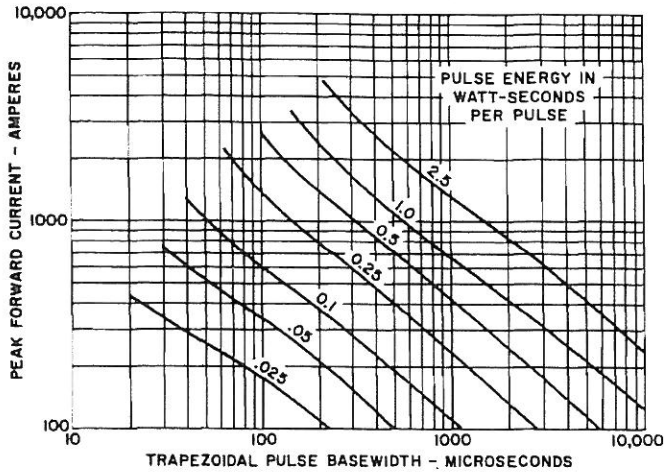

7. TRAPEZOIDAL PULSE ENERGY DI/DT
(RISING & FALLING) = 100 A/μs ($T_J = 175^\circ\text{C}$)

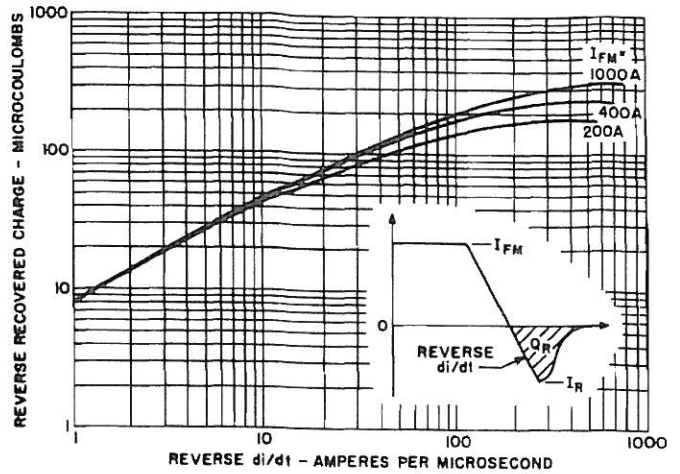

8. TYPICAL RECOVERED CHARGE ($T_J = 175^\circ\text{C}$)
FOR PARTS SUPPLIED VIA A398-X9 PART NUMBER,
GRAPH 8 REPRESENTS A MAXIMUM RECOVERED
CHARGE ($T_J = +175^\circ\text{C}$)

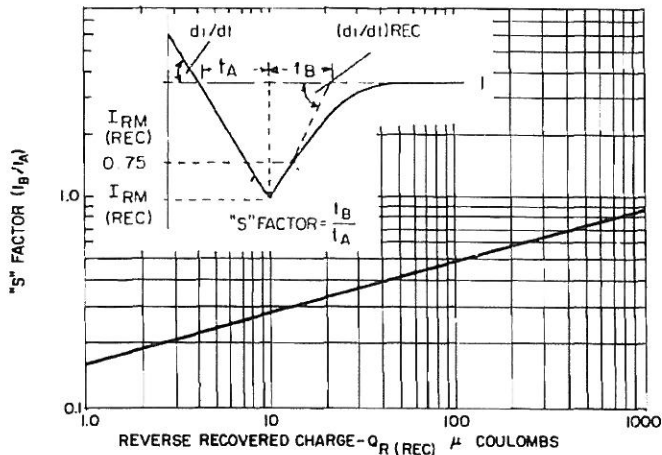

9. TYPICAL "S" FACTOR VERSUS RECOVERY
CHARGE ($T_J = 175^\circ\text{C}$)

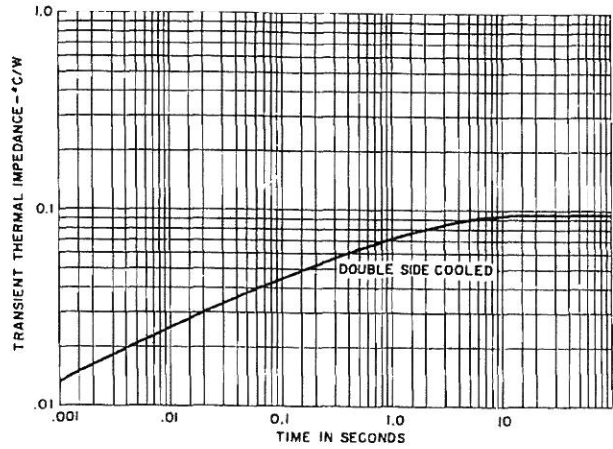

10. TRANSIENT THERMAL IMPEDANCE -
JUNCTION-TO-CASE

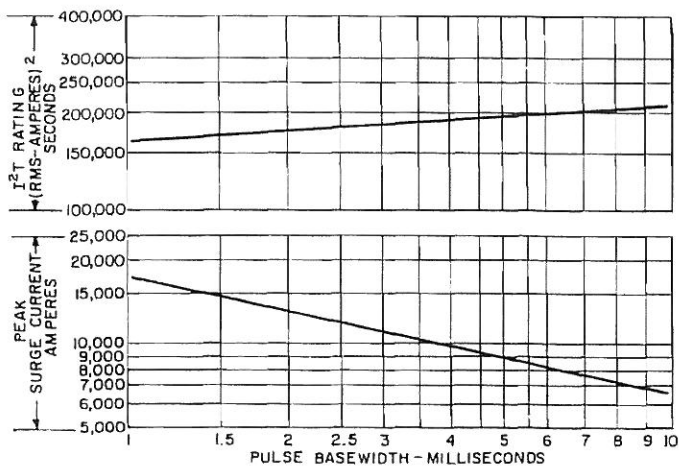

11. SUB-CYCLE SURGE FORWARD CURRENT
AND I^2t RATING VERSUS PULSE TIME
FOLLOWING RATED LOAD CONDITIONS

OUTLINE DRAWING

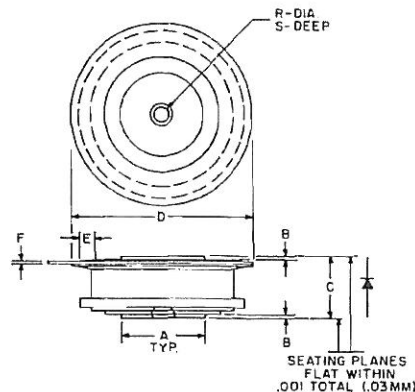

TABLE OF DIMENSIONS
Conversion Table

SYM	DECIMAL INCHES		METRIC MM	
	MIN.	MAX.	MIN.	MAX.
A	.744	.752	18.89	19.10
B	.030	.060	.76	1.52
C	.515	.565	13.08	14.35
D	1.600	1.656	40.64	41.91
E	1.10	-	2.79	-
F	.031	.017	.33	.43
R	.135	.145	3.42	3.68
S	.067	.083	1.70	2.1

SUGGESTED MOUNTING METHODS FOR PRESS-PAKS TO HEAT DISSIPATORS

When the Press-Pak is assembled to a heat sink in accordance with the following general instructions, a reliable and low thermal resistance interface will result:

1. Check each mating surface for nicks, scratches, flatness and surface finish. The heat dissipator mating surfaces should be flat within .0005 inch/inch and have a surface finish of 63 micro-inches.
2. It is recommended that the heat dissipator be plated with nickel, tin, or silver. Bare aluminum or copper surfaces will oxidize in time resulting in excessively high thermal resistance.

3. Sand each surface **lightly** with 600 grit paper just prior to assembly. Clean off and apply silicone oil (GE SF1154 200 centistoke viscosity) or silicone grease (GE G322L or Dow Corning DC 3, 4, 340 or 640). Clean off and apply again as a **thin** film. (A thick film will adversely affect the electrical and thermal resistances.)
4. Assemble with the specified mounting force applied through a self-leveling, swivel connection. The force has to be evenly distributed over the full area. Center holes on both top and bottom of the Press-Pak are for locating purposes only.

MOUNTING THE A398, ONE-HALF INCH PRESS-PAK USING THE SERIES 1000 CLAMP

CLAMP FEATURES:

- *Hardened Steel Pivot* insuring *constant pressure* in rugged applications over long periods.
- One-piece phenolic insulator gives added 1/2" creep distance.
- Use of special *Force Indicator Gauge* eliminates need for torque wrenches, inaccurate "flex" gauges and *guesswork*.
- Various bolt lengths available to accommodate most mounting situations.
- No loose parts to complicate assembly.
- Stiffening *brace* to reinforce heat sink available upon request.

- Single-side cooling terminal available upon request.
- Positive, non-binding swivel action.

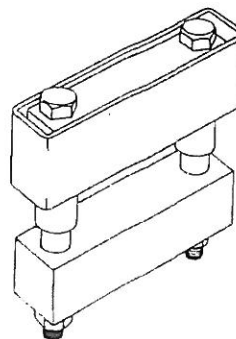

SERIES 1000

MOUNTING PROCEDURE:

With the semiconductor positively located in place on the heatsink(s), place the clamp in position with the bolts through the holes in the heatsink(s), and proceed as follows:

1. Refer to SCR Manual, Fifth Edition for Preparation of Mounting the Press-Pak SCR, 18.2.7.
2. Tighten the nuts evenly until finger tight.
3. Tighten each bolt 1/2 turn, using a 7/16 socket wrench on the bolt heads.
4. Place the Force Indicator Gauge firmly against the springs, as shown on the Outline Drawing, so that both ends and the middle are in solid contact with the springs. The holes of the gauge will then indicate the spring deflection, or force; correct mounting force is indicated when the holes coincide.

To Calibrate Force Gauge:

If the gauge is suspected of being out of calibration due to wear or damage, check it on a flat surface as shown below.

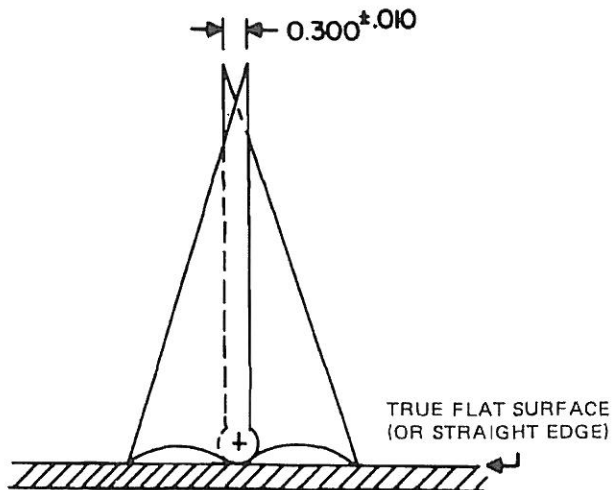

Examples:



Less than rated force. Tighten nuts alternately 1/4 turn at a time until points coincide.

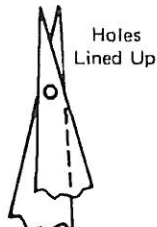

Correct Force

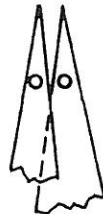

Excessive force. Loosen nuts and start over. **NEVER** try to adjust spring force by backing off the nuts, spring friction will produce false readings. Always start at Step 1.

If the points are not $0.300 \pm .010$ apart, calibrate the gauge by filing the bottom contact points.

PRINTED IN U.S.A.

5.2 Condensed Electrical and Thermal Characteristics and Ratings



109.1



183

RECTIFIERS 300 TO 450 AMPERES



324

JEDEC TYPE	—	—	—	—	—
GE TYPE	A230	A390	A397	A398	A432

SPECIFICATIONS

$I_{FM(AV)}$	Max. average forward (1 phase operation)	300	400	400	400	450	
	$T_C = (^{\circ}C)$	68	145	110	90	65	
V_{RM} (Rep)	Max. repetitive peak reverse voltage (V)	50-800	100-1500	100-1500	100-1500	1600-2600	
I_{FM} (Surge)	Max. peak one cycle, non-recurrent surge current (1 phase operation) 50 Hz.	5000	6600	4800	6500	7000	
	@ max. rated load conditions (A) 60 Hz.	5500	7000	5000	7000	7400	
I^2t	Max. non-repetitive for 1.5 msec (A^2sec)	95000	82000	51000	170000	98000	
T_J	Operating junction temperature range ($^{\circ}C$)	-40 to 175	-40 to 200	-40 to 125	-40 to 175	-40 to 150	
$R_{\theta JC}$	Max. thermal resistance, junction-to-case ($^{\circ}C/W$)	0.3	.15	.095	.095	.06	
V_{FM}	Max. peak forward voltage drop @ rated $I_{F(AV)}$ (1 phase operation)	1.2	1.4	1.75	1.7	2.65	
	@ $T_C = (^{\circ}C)$	68	144	25	25	65	
$Q_{R(REC)}$	Reverse recovered charge @ rated T_J (μc)	—	—	70	15	230	
t_{rr}	Reverse recovery time @ rated T_J (μs)	—	—	2.8	1.5	5	
V_F	Max. forward ⁽¹⁾ voltage drop for the current range:	$I_{MIN}(A)$	100	100	20	10	200
		$I_{MAX}(A)$	6000	8000	7000	9000	5000
		A	-.607	-.1115	.2337	-.02	.24
		B	.378	.2393	.1446	.18	.165
		C	.00081	.0005	.0004	.0004	.00067
$R_{\theta JC}$	Transient thermal ⁽²⁾ resistance for time:	D	-.05	-.0244	-.0055	-.0005	.01
		$T_{MIN}(S)$.001	.001	.001	.001	.001
		$T_{MAX}(S)$.01	.01	.01	.01	.01
		F	.128	.072	.072	.072	.29
		G	.431	.24	.24	.24	.61
Package Outline No.		324	109.1	109.1	109.1	183	
Maximum Stud Torque (In-Lbs/N-M)		15/1.7	—	—	—	—	
Max Mounting Force (Lbs/Kn)		—	800/3.56	800/3.56	800/3.56	2000/8.9	
Expanded Electrical Characterization, see page:		152	157	158	160	165	

⁽¹⁾Voltage Drop Model: $V_F = A + B \cdot L_N(I) + C \cdot I + D \cdot \sqrt{I}$

⁽²⁾Transient Thermal Resistance Model: $R_{\theta JC} = F \cdot t^G$