



D10 Expert™ – Dual Discrete Outputs

Advanced sensor for use with plastic fiber optics



Features

- Easy-to-set automatic *Expert*-style TEACH options* including static, dynamic, and single-point programming plus manual adjustment for fine-tuning
- 16-bit microcontroller and 12-bit Analog-to-Digital converter for high-performance, low-contrast sensing
- Easy-to-read 4-digit display for TEACH and signal strength readout, plus indicators for a continuous readout of operating status (user configurable)
- Two discrete outputs, PNP or NPN
- Four-mode power and speed selection with automatic cross-talk avoidance circuitry
- Selectable OFF-delay options
- Gate input wire can be used to selectively inhibit sensor outputs from switching
- Models available with visible red (680 nm) or visible green (525 nm) sensing beam
- Models available with 2 m or 9 m (6.5' or 30') cable or integral Pico-style quick-disconnect
- Sleek, ultra-slim 10 mm housing, mounts to a standard 35 mm DIN rail

* U.S. Patent #5,808,296

Models

| Models | | Cables* | Discrete Outputs |
|----------|------------|---------------------|------------------|
| Red Beam | Green Beam | | |
| D10DNFP | D10DNFPG | 2 m (6.5') Cable | NPN |
| D10DNFPQ | D10DNFPGQ | 6-pin Pico-style QD | |
| D10DPFP | D10DPFPG | 2 m (6.5') Cable | PNP |
| D10DPFPQ | D10DPFPGQ | 6-pin Pico-style QD | |

* 9 m (30') cables are available by adding suffix "W/30" to the model number of any cabled sensor (e.g., **D10DNFP W/30**).
A model with a QD connector requires a mating cable (see page 14).



WARNING . . . Not To Be Used for Personnel Protection

Never use these products as sensing devices for personnel protection. Doing so could lead to serious injury or death.

These sensors do NOT include the self-checking redundant circuitry necessary to allow their use in personnel safety applications. A sensor failure or malfunction can cause either an energized or de-energized sensor output condition. Consult your current Banner Safety Products catalog for safety products which meet OSHA, ANSI and IEC standards for personnel protection.

D10 Expert™ Dual Discrete Outputs

Overview

The D10 *Expert* Sensor is a high-performance plastic fiber-optic sensor whose many configuration (TEACH-mode) options make it suitable for demanding applications. Even with all its features, it is extremely easy to use. Advanced 16-bit microcontroller technology makes this possible.

The D10 *Expert* provides high-performance sensing in low-contrast applications. *Expert* TEACH and setup options provide static, dynamic and single-point programming plus manual fine adjustment, remote programming and push button lockout. Its slender, stylized housing has a large digital display visible beneath a clear cover for easy programming and status monitoring during operation. The sensor mounts directly to standard 35 mm DIN rail or using the supplied mounting bracket.

The sensor features two outputs with independent setpoints: either NPN or PNP, depending on model. Built-in crosstalk avoidance protocol provides trouble-free operation for multiple sensors in one area.

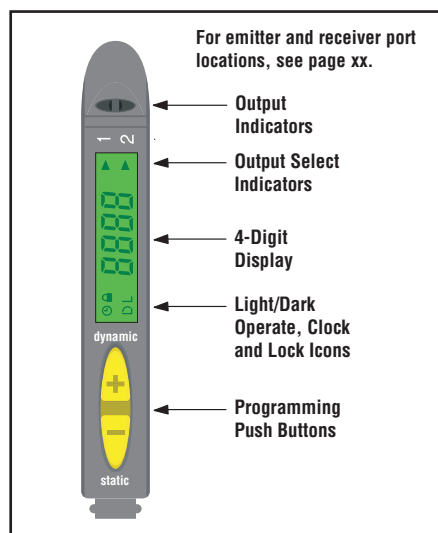

Figure 1. D10 features

| | | | | | | | | | |
|-------------------------------------|---|-------------------|------------------------|-------------------|------------------------|-------------------|-------------------------------|-------------------|---------------------|
| Light/Dark Operate Selection | Toggle to select the condition for which each output will conduct: when the target is present or when the target is absent. | | | | | | | | |
| OFF-Delay Timing Selection | Programmable OFF-delay pulse stretcher: 0, 2, 5, 10, 15, 20, 30, 40, 60, 80, or 100 milliseconds | | | | | | | | |
| Display Selection | Discrete Output: Raw signal value or % excess signal | | | | | | | | |
| Power Level/Speed Selection | Super High-Speed† (SHS) | | High-Speed (HS) | | High-Power (HP) | | Super High-Power (SHP) | | |
| Response* | 50 µs | | 200 µs | | 1 ms | | 2.5 ms | | |
| Repeatability | 25 µs | | 50 µs | | 75 µs | | 100 µs | | |
| Maximum Range* | Fiber | Red 680 nm | Green 525 nm | Red 680 nm | Green 525 nm | Red 680 nm | Green 525 nm | Red 680 nm | Green 525 nm |
| | PIT16U | 20 mm | 9 mm | 30 mm | 9 mm | 55 mm | 13 mm | 90 mm | 16 mm |
| | PIT26U | 100 mm | 40 mm | 150 mm | 40 mm | 250 mm | 55 mm | 400 mm | 70 mm |
| | PIT46U | 300 mm | 100 mm | 550 mm | 100 mm | 1000 mm | 160 mm | 1200 mm | 180 mm |
| | PIT66U | 600 mm | 180 mm | 1000 mm | 180 mm | 1700 mm | 280 mm | 2400 mm | 320 mm |
| | PBT16U | 6 mm | ** | 10 mm | ** | 18 mm | 3 mm | 30 mm | 3.5 mm |
| | PBT26U | 30 mm | 12 mm | 50 mm | 12 mm | 100 mm | 20 mm | 150 mm | 25 mm |
| | PBT46U | 100 mm | 30 mm | 175 mm | 30 mm | 250 mm | 42 mm | 300 mm | 60 mm |
| PBT66U | 175 mm | 55 mm | 250 mm | 55 mm | 400 mm | 80 mm | 475 mm | 100 mm | |
| Tracking Feature | Sets Output 2 to identical settings as Output 1; Output 2 settings can then be revised as desired. (See Advanced Setup procedure, page 11.) | | | | | | | | |
| Factory Default Settings | The following settings are preset at the factory; revert sensor to factory defaults using Advanced Setup procedure (page 11). <ul style="list-style-type: none"> • Light operate (LO) • No OFF-delay (t0) • Raw signal value (1234) • Output 1 displayed • High Speed (HS); 200 µs response • Maximum power setting • Discrete: switchpoint positioned at middle of range | | | | | | | | |

* Diffuse mode performance based on 90% reflectance white test card.

** ø0.010" bifurcated fiber not recommended in these speed settings. Contact Banner Applications for more information.

† See note on page 10.

D10 Expert™ Dual Discrete Outputs

Sensor Programming

Programming Procedures

Two push buttons, Dynamic (+) and Static (-), may be used to access and set programming parameters. For remote programming, connect a switch or digital input to the gray wire; length of the individual pulses is equal to the value T:

$$0.04 \text{ seconds} \leq T \leq 0.8 \text{ seconds}$$

Returning to RUN mode



TEACH and SETUP modes each may be exited in one of two ways: by exercising the 60-second time-out, or by cancelling out of the process. In TEACH mode, the sensor will return to RUN mode without saving any of the new settings; in SETUP mode, the sensor will return to RUN mode but save all of the settings. To cancel out of TEACH mode, press and hold the Static (-) button for 2 seconds; to cancel out of SETUP mode, press and hold both the Static (-) and Dynamic (+) buttons for 2 seconds.

Output 2

The setpoint(s) for each output can be set independently of one another (see Super-High-Speed Operation). However, the functional range available for output 2 is dictated by the automatic power and gain settings established for output 1. Whenever output 1 is taught, output 2 also must be retaught. Applications hint: teach the weakest signal on output 1 first.

Active Channel Select

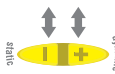
- Selects which channel to teach
- Displays channel configuration information.

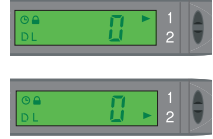
| Active Channel Select | Push Button | Remote 0.04 sec. ≤ T ≤ 0.8 sec. | Result |
|-----------------------|---|--|---|
| | <ul style="list-style-type: none"> • Single-click both buttons simultaneously.  | <ul style="list-style-type: none"> • Triple-pulse the remote line.*  | <p>Pointer icon: moves to the other channel indicator.</p>  |

* NOTE: Triple-pulse will change the display, but will not save. To save Channel Select, make an adjustment to that channel as a TEACH, SET, or Sensor Setup.

D10 Expert™ Dual Discrete Outputs

Two-Point Static TEACH (Threshold)

- Establishes a single switching threshold
- Threshold position is adjustable using “+” and “-” buttons (see Manual Adjust, page 9)

Static TEACH is the traditional setup method, used when two conditions can be presented by the user. The sensor locates a single sensing threshold (the switchpoint) midway between the two taught conditions, with the Output ON condition on one side, and the Output OFF condition on the other (see Figure 2).

The first condition taught is the ON condition. The Output ON and OFF conditions can be reversed by changing Light/Dark Operate status in SETUP mode (see page 10).

Static TEACH and Manual Adjust

Using Manual Adjust with Static TEACH moves the switching threshold.

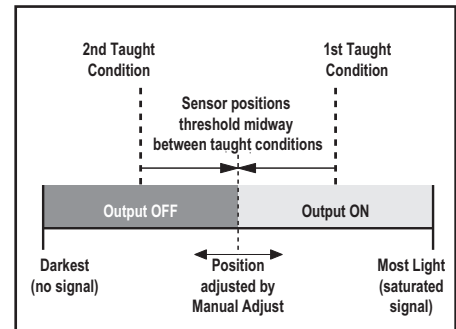

Figure 2. Static TEACH (Light Operate shown)

| Contrast Values | |
|-----------------|---|
| 500+ | Excellent: Very stable operation. |
| 100-500 | Good: Minor sensing variables will not affect sensing reliability. |
| 32-99 | Low: Minor sensing variables may affect sensing reliability. |
| 0-31 | Marginal: Consider an alternate sensing scheme. |

Figure 3. Contrast Values

| | Push Button | Remote 0.04 sec. ≤ T ≤ 0.8 sec. | Result |
|----------------------------|---|--|--|
| Access Static TEACH Mode | <ul style="list-style-type: none"> • Press and hold Static (-) button > 2 seconds. | <ul style="list-style-type: none"> • No action required; sensor is automatically ready for 1st TEACH condition. | <ul style="list-style-type: none"> • Display flashes "1st" • Arrow icon turns red |
| TEACH Output ON Condition | <ul style="list-style-type: none"> • Present Output ON condition. • Click Static button. | <ul style="list-style-type: none"> • Present Output ON condition. • Single-pulse the remote line. | <ul style="list-style-type: none"> • Display flashes "2nd" |
| TEACH Output OFF Condition | <ul style="list-style-type: none"> • Present Output OFF condition. • Click Static button. | <ul style="list-style-type: none"> • Present Output OFF condition. • Single-pulse the remote line. | <p>TEACH conditions acceptable:</p> <ul style="list-style-type: none"> • Display flashes "pass," followed by a number (denoting contrast); see Figure 3. • Sensor returns to RUN mode with new settings. • Arrow icon turns green |
| | | | <p>TEACH conditions unacceptable:</p> <ul style="list-style-type: none"> • Display flashes "fail" and returns to "1st" • Arrow icon remains red • After 60 seconds, sensor returns to RUN mode (Arrow icon turns green) without changing settings. |

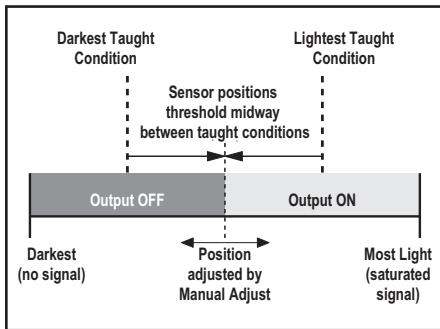

Figure 4. Dynamic TEACH (Light Operate shown)

| Contrast Values | |
|-----------------|---|
| 500+ | Excellent: Very stable operation. |
| 100-500 | Good: Minor sensing variables will not affect sensing reliability. |
| 32-99 | Low: Minor sensing variables may affect sensing reliability. |
| 0-31 | Marginal: Consider an alternate sensing scheme. |

Figure 5. Contrast Values

Dynamic TEACH and Adaptive Thresholds







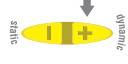

- TEACH on-the-fly.
- Sets a single threshold.
- Threshold position is adjustable using the “+” and “-” buttons (see Manual Adjust, page 9).

Dynamic TEACH is used to program sensitivity during actual machine run conditions. During Dynamic TEACH, the sensor takes multiple samples of the light and dark conditions and automatically sets the sensitivity at the optimum level. Dynamic TEACH activates the sensor’s adaptive threshold system, which continuously tracks minimum and maximum signal levels, and automatically maintains centering of the switch point between the light and dark conditions. The adaptive threshold system remains in effect during RUN mode to automatically adjust for changes in the light or the dark conditions.

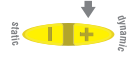
When Dynamic TEACH mode is used to program sensitivity, the output ON state (light or dark operate) will remain as it was last programmed. To change to either light or dark operate, use the SETUP mode (see page 10).

Dynamic TEACH and Manual Adjust

Sensitivity may be adjusted at any time when the sensor is in RUN mode by clicking the “+” and “-” buttons. However, when a manual adjustment is made, the adaptive threshold system is disabled (cancelled).

| | Push Button | Remote 0.04 sec. ≤ T ≤ 0.8 sec. | Result |
|----------------------------------|---|---|---|
| Access Dynamic TEACH Mode | <ul style="list-style-type: none"> • Press and hold Dynamic (+) button.  | <ul style="list-style-type: none"> • Hold remote line low (to ground).  | <ul style="list-style-type: none"> • Display flashes “dyn” • Arrow icon turns red  |
| TEACH Sensing Conditions | <ul style="list-style-type: none"> • Present Output ON/OFF conditions while continuing to hold Dynamic button.  | <ul style="list-style-type: none"> • Present Output ON/OFF conditions while continuing to hold remote line low (to ground)  | |
| Return to RUN Mode | <ul style="list-style-type: none"> • Release Dynamic button.  | <ul style="list-style-type: none"> • Release remote line/switch.  | <p>TEACH conditions acceptable:</p> <ul style="list-style-type: none"> • Display flashes “pass,” followed by a number (denoting contrast); see Figure 5. • Sensor returns to RUN mode with new settings. • Arrow icon turns green  |
| | | | <p>TEACH conditions unacceptable:</p> <ul style="list-style-type: none"> • Display flashes “fail” • Arrow icon remains red • Sensor returns to RUN mode (Arrow icon turns green) without changing settings.  |

D10 Expert™ Dual Discrete Outputs

Single-Point Window SET

- Sets a single ON condition that extends 200 counts above and below the taught condition (including ±100 counts hysteresis)
- All other conditions (lighter or darker) result in OFF output
- Sensing window (sensitivity) is adjustable using “+” and “-” buttons (see Manual Adjust, page 9)

Window SET is most useful when a product may not always appear in the same place, or when other signals may appear. Window SET designates a sensing window, with the Output ON condition inside the window, and the Output OFF conditions outside the window (see Figure 6). The sensor accepts a single sensing condition, and adds switching thresholds and hysteresis above and below that condition to create a sensing window. Output ON and OFF conditions can be reversed by changing Light/Dark Operate status in SETUP mode.

Window SET and Manual Adjust

Using Manual Adjust with Window SET expands or contracts the size of the window.

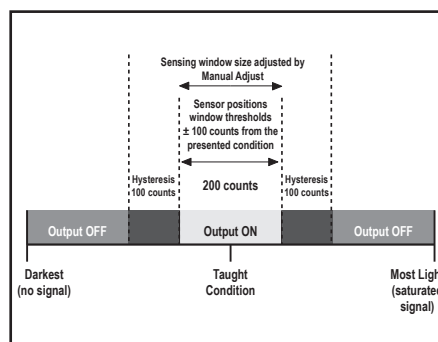

Figure 6. Single-Point Window SET and Hysteresis (Light Operate shown)

| | Push Button | Remote 0.04 sec. ≤ T ≤ 0.8 sec. | Result |
|-----------------------|---|---|--|
| Access SET Mode | <ul style="list-style-type: none"> • Press and hold Static (-) button > 2 seconds. | | <ul style="list-style-type: none"> • Display flashes “1st” • Arrow icon turns red |
| | | <ul style="list-style-type: none"> • Present sensing condition. • Single-pulse the remote line. | <ul style="list-style-type: none"> • Display flashes “2nd” • Arrow icon turns red |
| SET Sensing Condition | <ul style="list-style-type: none"> • Present sensing condition. • Double-click the Static button. | <ul style="list-style-type: none"> • Double-pulse the remote line. | <p>TEACH conditions acceptable:</p> <ul style="list-style-type: none"> • Display flashes “sngl,” then “pt” twice • Sensor returns to RUN mode with new settings. • Arrow icon turns green <p>TEACH conditions unacceptable:</p> <ul style="list-style-type: none"> • Display flashes “fail” and returns to “1st” • Arrow icon remains red • After 60 seconds, sensor returns to RUN mode (Arrow icon turns green) without changing settings. |

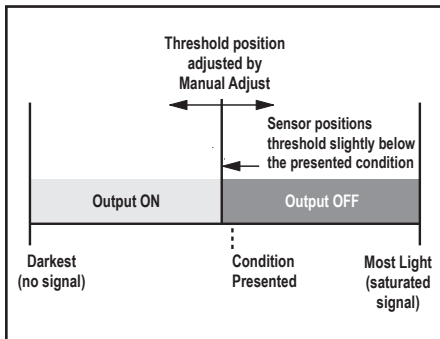

Figure 7. Single-Point Light SET (Dark Operate shown)

| Mode | Threshold Offset (counts below taught signal value) |
|------------------|---|
| Super High-Speed | 30 |
| High-Speed | 22 |
| High-Power | 9 |
| Super High-Power | 6 |

Figure 8. Light SET Threshold Offset

Single-Point Light SET

- Sets a threshold slightly below the taught condition (see Figure 7)
- Any condition darker than the threshold condition causes the output to change state
- Threshold position is adjustable using “+” and “-” buttons (see Manual Adjust, page 9)
- Recommended for applications where only one condition is known, for example a stable light background with varying darker targets.

A single sensing condition is presented, and the sensor positions a threshold slightly below the presented condition. When a condition darker than the threshold is sensed, the output either turns ON or OFF, depending on the Light/Dark Operate setting (see Sensor Setup, page 10).

Light SET and Light/Dark Operate Selection

Light SET teaches the Output OFF condition and forces the sensor into Dark Operate (DO) mode. The sensor can be reconfigured to Light Operate (LO) mode after the condition has been taught (see Sensor Setup, page 10).

| | Push Button 0.04 seconds ≤ “Click” ≤ 0.8 seconds | Remote Line 0.04 seconds ≤ T ≤ 0.8 seconds | Result |
|--------------------------|---|--|--|
| Access SET Mode | <ul style="list-style-type: none"> • Press and hold Static push button > 2 seconds | <ul style="list-style-type: none"> • Single-pulse remote line | Push Button <ul style="list-style-type: none"> • Display flashes “1st” • Arrow icon turns red |
| | | | Remote <ul style="list-style-type: none"> • Display flashes “2nd” • Arrow icon turns red |
| SET Output OFF Condition | <ul style="list-style-type: none"> • Present Output OFF condition • Four-click Static push button | <ul style="list-style-type: none"> • Present Output OFF condition • Four-pulse remote line | Threshold Condition Accepted <ul style="list-style-type: none"> • Display flashes “sngl” then “Lt” twice • Sensor returns to RUN mode with new settings • Arrow icon turns green |
| | | | Threshold Condition Unacceptable <ul style="list-style-type: none"> • Display flashes “fail” and returns to “1st” • Arrow icon remains red • After 60 seconds, sensor returns to RUN mode (Arrow icon turns green) without changing settings |

D10 Expert™ Dual Discrete Outputs

Single-Point Dark SET

- Sets a threshold slightly above the taught condition (see figure 9).
- Any condition lighter than the threshold condition causes the output to change state.
- Threshold position is adjustable using “+” and “-” buttons (see Manual Adjust, page 9)
- Recommended for applications where only one condition is known, for example a stable dark background with varying lighter targets.

A single sensing condition is presented, and the sensor positions a threshold slightly above the taught condition. When a condition lighter than the threshold is sensed, the output either turns ON or OFF, depending on the Light/Dark Operate setting (see Sensor Setup, page 10.)

Dark SET and Light/Dark Operate Selection

Dark SET teaches the Output OFF condition and forces the sensor into Light Operate (LO) mode. The sensor can be reconfigured to Dark Operate (DO) mode after the condition has been taught (see Sensor Setup, page 10).

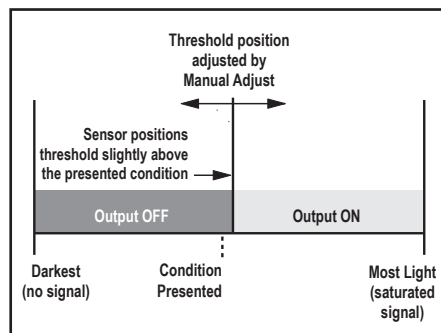

Figure 9. Single-Point Dark SET (Light Operate shown)

| Mode | Threshold Offset (counts above taught signal value) |
|------------------|---|
| Super High-Speed | 30 |
| High-Speed | 22 |
| High-Power | 9 |
| Super High-Power | 6 |

Figure 10. Dark SET Threshold Offset

| | Push Button 0.04 seconds ≤ “Click” ≤ 0.8 seconds | Remote Line 0.04 seconds ≤ T ≤ 0.8 seconds | Result |
|--------------------------|---|--|---|
| Access SET Mode | <ul style="list-style-type: none"> • Press and hold Static push button > 2 seconds | <ul style="list-style-type: none"> • Single-pulse remote line | <p>Push Button</p> <ul style="list-style-type: none"> • Display flashes “1st” • Arrow icon turns red |
| | | | <p>Remote</p> <ul style="list-style-type: none"> • Display flashes “2nd” • Arrow icon turns red |
| SET Output OFF Condition | <ul style="list-style-type: none"> • Present Output OFF condition • Five-click Static push button | <ul style="list-style-type: none"> • Present Output OFF condition • Five-pulse remote line | <p>Threshold Condition Accepted</p> <ul style="list-style-type: none"> • Display flashes “sngl” then “dr” twice • Sensor returns to RUN mode with new settings • Arrow icon turns green |
| | | | <p>Threshold Condition Unacceptable</p> <ul style="list-style-type: none"> • Display flashes “fail” and returns to “1st” • Arrow icon remains red • After 60 seconds, sensor returns to RUN mode (Arrow icon turns green) without changing settings |

Manual Adjust





Manual Adjust is used during RUN mode and is accomplished via the push buttons only. Its behavior depends on whether a switching threshold or a sensing window is used.

Switching Threshold:

- Fine-tunes sensing sensitivity
- Press “+” to increase; press “-” to decrease

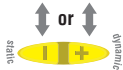
Sensing Window:













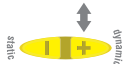

















- Adjusts sensing window size (tolerance) for the single-point target condition
- Press “+” to increase; press “-” to decrease

| | Push Button | Remote | Result |
|---------------|--|--|---|
| Manual Adjust | <ul style="list-style-type: none"> • Click “+” to increase, or click “-” to decrease.  | <ul style="list-style-type: none"> • Not available with remote programming. | <ul style="list-style-type: none"> • Display briefly flashes the threshold setpoint value as it is being changed.  <p>or</p>  <ul style="list-style-type: none"> • Display flashes “inc” or “dec” as the window size is adjusted. <p style="text-align: center;">or</p>   |

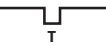
D10 Expert™ Dual Discrete Outputs

Sensor Setup













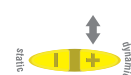

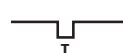
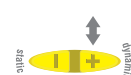

- Configures sensor display and operating parameters.
- Changes are updated instantly.
- Click Dynamic (+) or double-pulse remote line to select an option.
- Click Static (-) or single-pulse remote line to advance.

| | Push Button | Remote 0.04 sec. ≤ T ≤ 0.8 sec. | Result | |
|---|--|--|---|--|
| Access SETUP Mode | <ul style="list-style-type: none"> • Press and hold both buttons concurrently for > 2 seconds.  | <ul style="list-style-type: none"> • Double-pulse the remote line.  | <ul style="list-style-type: none"> • Indicator Arrow Icon 1 ON Red | |
| Select Light/Dark Operate | <ul style="list-style-type: none"> • Click Dynamic (+) to toggle between selections.  | <ul style="list-style-type: none"> • Double-pulse remote line to toggle between selections.  | Light Operate: <ul style="list-style-type: none"> • Display flashes "lo" • L icon  | |
| | <ul style="list-style-type: none"> • Click Static (-) to save selection and advance to "OFF-Delay."  | <ul style="list-style-type: none"> • Single-pulse the remote line to save selection and advance to "OFF-Delay."  | Dark Operate: <ul style="list-style-type: none"> • Display flashes "do" • D icon  | |
| Select OFF-Delay Timing Enable | <ul style="list-style-type: none"> • Click Dynamic (+) to toggle between selections.  | <ul style="list-style-type: none"> • Double-pulse the remote line to toggle between selections.  | OFF (No OFF-Delay): <ul style="list-style-type: none"> • "t 0" • Clock icon OFF  | |
| | <ul style="list-style-type: none"> • Click Static (-) to save selection and advance to "Display."  | <ul style="list-style-type: none"> • Single-pulse the remote line to save selection and advance to "Display."  | 2 to 100 ms OFF-Delay: <ul style="list-style-type: none"> • "t 2," "t 5," "t 10," "t 15," "t 20," "t 30," "t 40," "t 60," "t 80," or "t100" • Clock icon ON  | |
| Select Display Parameters | <ul style="list-style-type: none"> • Click Dynamic (+) to toggle between selections.  | <ul style="list-style-type: none"> • Double-pulse the remote line to toggle between selections.  | Raw signal value: <ul style="list-style-type: none"> • "1234"  | |
| | <ul style="list-style-type: none"> • Click Static (-) to save selection and advance to "Power/Speed."  | <ul style="list-style-type: none"> • Single-pulse the remote line to save selection and advance to "Power/Speed."  | Percent of excess signal: <ul style="list-style-type: none"> • "123P"  | |
| Select Speed and Power Combination | <ul style="list-style-type: none"> • Click Dynamic (+) to toggle between selections.  | <ul style="list-style-type: none"> • Double-pulse the remote line to toggle between selections.  | <ul style="list-style-type: none"> • Indicator Arrow Icons 1 and 2 ON Red Super-high-speed (50-µs response) <ul style="list-style-type: none"> • "SHS" (Complementary outputs; see note below)  | |
| | <ul style="list-style-type: none"> • Return to RUN mode. | <ul style="list-style-type: none"> • Click Static (-) to save selection and return to RUN mode.  | <ul style="list-style-type: none"> • Single-pulse the remote line to save selection and return to RUN mode.  | High-speed (200-µs response) <ul style="list-style-type: none"> • "HS"  |
| | OR | <ul style="list-style-type: none"> • Quad-click Static (-) to proceed to Advanced Setup.  | <ul style="list-style-type: none"> • Quad-click the remote line to proceed to Advanced Setup.  | High-power (1-ms response) <ul style="list-style-type: none"> • "HP"  |
| <ul style="list-style-type: none"> • Proceed to Advanced Setup | | | Super-high-power (2.5-ms response) <ul style="list-style-type: none"> • "SHP"  | |
| | | | <ul style="list-style-type: none"> • See Advanced Setup (page 5). | |

Super-High-Speed Operation Note: Under most conditions, the sensor's two discrete outputs operate independently. However, the outputs become complementary when operating at Super-High-Speed, due to its extremely fast response time. Only channel 1 is taught/adjusted; channel 2 is complementary to it (output 1 conducts for the taught ON condition, and output 2 conducts for the OFF state). To invert these conditions (output 1 – OFF condition, output 2 – ON), change light/dark operate setting.

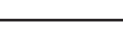
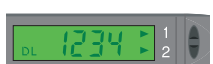

Advanced Setup

- Advanced adjustments to previously configured sensor display and operating parameters.
- Quad-click Static (-) or quad-pulse remote line before exiting "Power and Speed" settings to enter this mode.
- Click Dynamic (+) or double-pulse remote line to select an option.
- Click Static or single-pulse remote line to advance.
- Changes are updated instantly.

| | Push Button | Remote 0.04 sec. ≤ T ≤ 0.8 sec. | Result |
|---------------------------------|--|--|---|
| Enter SETUP Mode | <ul style="list-style-type: none"> • From "Power and Speed" mode, quad-click Static (-) button.  | <ul style="list-style-type: none"> • From "Power and Speed" mode, quad-click the remote line.  | <ul style="list-style-type: none"> • Indicator Arrow Icons 1 and 2 remain red • Display shows "Tracking Enabled" option.  |
| Track Enable | <ul style="list-style-type: none"> • Click Dynamic (+) to toggle between selections.  | <ul style="list-style-type: none"> • Double-pulse the remote line to toggle between selections.  | <ul style="list-style-type: none"> • Sets output 2 identical to output 1 • Tracking disabled: Display shows "tr n" • Tracking enabled: Display shows "tr y"   |
| | <ul style="list-style-type: none"> • Click Static (-) to save selection and advance to "Factory Default."  | <ul style="list-style-type: none"> • Single-pulse the remote line to save selection and advance to "Factory Default."  | |
| Factory Default Settings | <ul style="list-style-type: none"> • Click Dynamic (+) to toggle between selections.  | <ul style="list-style-type: none"> • Double-pulse the remote line to toggle between selections.  | <ul style="list-style-type: none"> • Returns to factory default factory settings • Factory Default Settings Not Selected: Display shows "fd n" • Factory Default Settings Selected: Display shows "fd y"   |
| | <ul style="list-style-type: none"> • Click Static (-) to advance to "Display Orientation."  | <ul style="list-style-type: none"> • Single-pulse the remote line to advance to "Display Orientation."  | |
| Display Orientation | <ul style="list-style-type: none"> • Click Dynamic (+) to toggle between selections.  | <ul style="list-style-type: none"> • Double-pulse the remote line to toggle between selections.  | <ul style="list-style-type: none"> • Inverts display to read "upside-down" • Normal: For example: 1234 • Inverted: For example: 4321 NOTE: Icons do not invert.   |
| | <ul style="list-style-type: none"> • Click Static (-) to return to RUN mode.  | <ul style="list-style-type: none"> • Single-pulse the remote line to return to RUN mode.  | |

Push Button Lockout

- Prevents unwanted adjustments or tampering of the push buttons.
- Push buttons can be enabled or disabled only from the remote line and only during normal RUN mode.

| | Push Button | Remote 0.04 sec. ≤ T ≤ 0.8 sec. | Result |
|---------------------------------------|---|---|---|
| Enable or Disable Push Buttons | <ul style="list-style-type: none"> • Not available with push-button programming. | <ul style="list-style-type: none"> • From RUN mode, quad-pulse the remote line to toggle between selections.  | <ul style="list-style-type: none"> • Push Buttons Disabled: Display flashes "loc", Padlock icon appears, Sensor remains in RUN mode • Push Buttons Enabled: Display flashes "uloc", Padlock icon disappears, Sensor remains in RUN mode   |

D10 Expert™ Dual Discrete Outputs

Self-Diagnostic Error Modes

In the unlikely event that the setup parameters are lost or become corrupt, the display will continuously scroll: "USEr PSF Error." Reteach the sensor to recover. If the problem persists, contact your Banner representative for further information.

Gate Input

The pink wire is configured as a gate input. When this wire is pulled low (i.e., to the sensor ground; 0-0.5V dc), it inhibits the outputs from switching, while all other sensor functions continue to be enabled. This feature is useful for controlling when the outputs are allowed to change states. Gate input function response time is 1 millisecond.

Specifications

| | | | |
|------------------------------------|---|-----------------------------------|---------------------------|
| Required Fiber-Optic Cable | Banner P-Series plastic fibers | | |
| Sensing Beam | Visible red, 680 nm, or Visible green, 525 nm, depending on model | | |
| Supply Voltage and Current | 12 to 24V dc (10% maximum ripple) at less than 65 mA, exclusive of load | | |
| Supply Protection Circuitry | Protected against reverse polarity and transient voltage | | |
| Output Configuration | 2 NPN or 2 PNP, depending on model | | |
| Output Rating | 150 mA maximum load OFF-state leakage current: < 10 μ A at 24V dc ON-state saturation voltage: NPN < 1.5V at 150 mA load PNP < 2.5V at 150 mA load | | |
| Output Protection Circuitry | Protected against false pulse on power-up and continuous short-circuit | | |
| Output Response Time | Programmable, 50 microseconds, 200 microseconds, 1 millisecond, 2.5 milliseconds NOTE: < 1 second delay on power-up; outputs do not conduct during this time. | | |
| Adjustments | Push-button or remote programming of response time, OFF-delay, light/dark operate, and display | | |
| Indicators | Four-digit digital display plus LED indicators for active channel, push-button lockout, OFF-delay and light/dark operate selection; 2 yellow output indicators | | |
| Construction | Black ABS/polycarbonate alloy (UL94 V-0 rated) housing, clear polycarbonate cover | | |
| Environmental Rating | NEMA 1, IEC IP50 | | |
| Connections | PVC-jacketed 2 m or 9 m (6.5' or 30') 6-wire integral cable or integral 6-pin Pico-style quick-disconnect | | |
| Operating Conditions | Temperature: -20° to +55°C (-4° to +131°F) Storage Temperature: -20° to +80°C (-4° to +175°F) Max. Rel. Humidity: 90% @ 50°C (non-condensing) | | |
| | Number of Devices, Stacked | Ambient Temperature Rating | Load Specification |
| | 3 | 55°C | 150 mA |
| | 7 | 50°C | 50 mA |
| 10 | 45°C | 50 mA | |
| Installation | 35 mm DIN rail or included mounting bracket | | |
| Certifications |  | | |

D10 Expert™ Dual Discrete Outputs

Dimensions

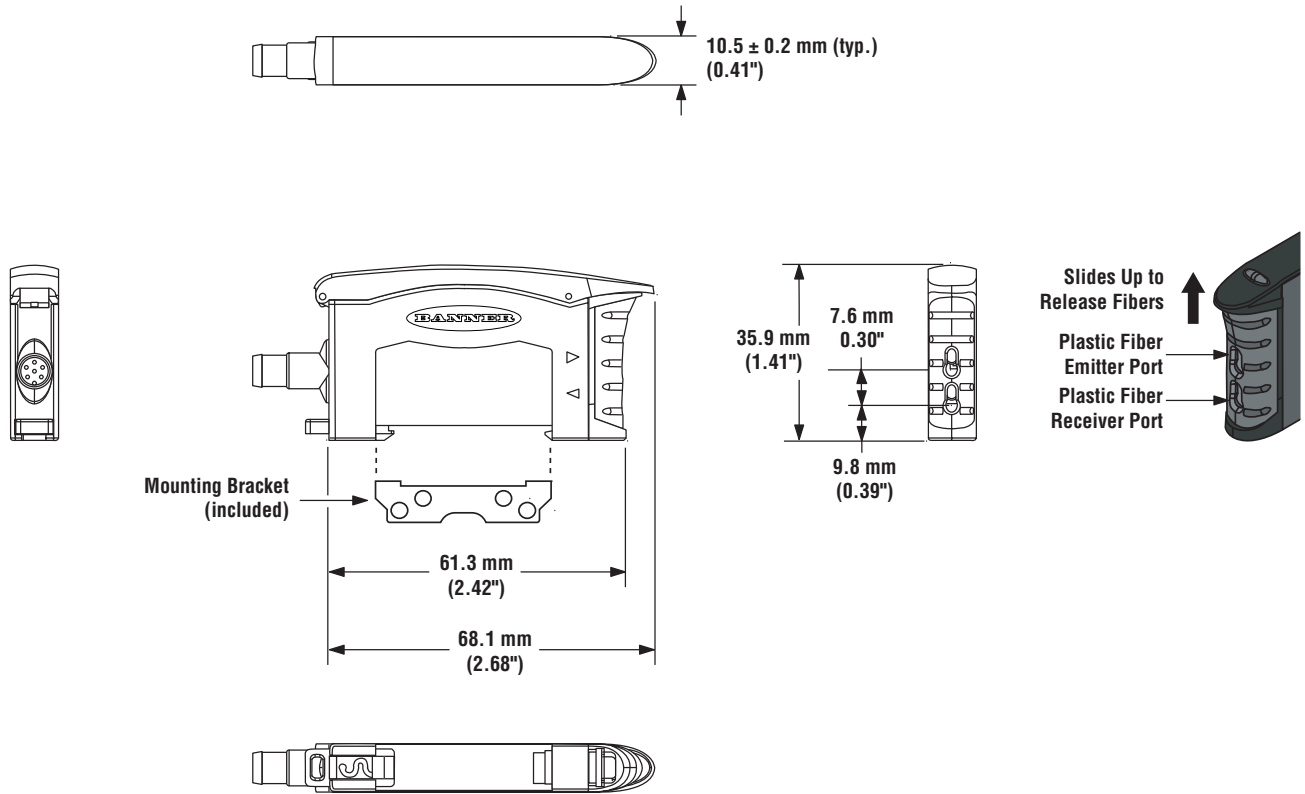

Included Bracket Dimensions

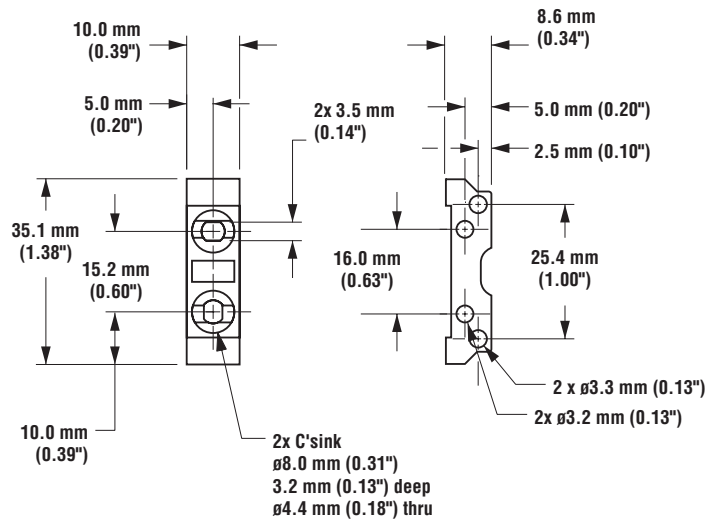

M3 Hardware included:
 Lock Washer (2)
 Flat Washer (2)
 Screws (2)
 Hex Nuts (2)

D10 Expert™ Dual Discrete Outputs

Hookups

NPN Output Models

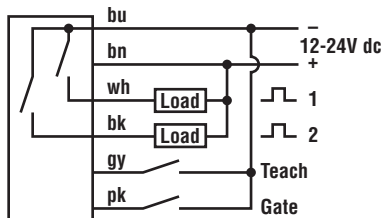

PNP Output Models

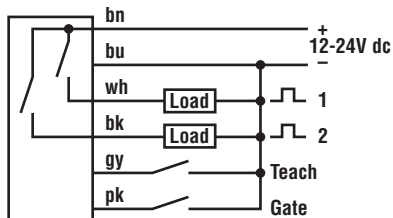

NOTE: QD hookups are functionally identical.

Accessories

Pico-Style Quick-Disconnect Cables

Cable: PUR jacket, polyurethane connector body, POM snap-lock coupling

Conductors: 26 or 24 AWG high-flex stranded, gold-plated contacts

Temperature: -40° to +90°C (-40° to +194°F)

Voltage Rating: 30V ac/36V dc

| Style | Model | Length | Dimensions | Pin-out |
|-------------------|---------|------------|------------|---------|
| 6-Pin Straight | PKG6Z-2 | 2 m (6.5') | | |
| | PKG6Z-9 | 9 m (30') | | |
| 6-Pin Right-angle | PKW6Z-2 | 2 m (6.5') | | |
| | PKW6Z-9 | 9 m (30') | | |

D10 Expert™ Dual Discrete Outputs

D10 Expert™ Dual Discrete Outputs



WARRANTY: Banner Engineering Corp. warrants its products to be free from defects for one year. Banner Engineering Corp. will repair or replace, free of charge, any product of its manufacture found to be defective at the time it is returned to the factory during the warranty period. This warranty does not cover damage or liability for the improper application of Banner products. This warranty is in lieu of any other warranty either expressed or implied.