

FEATURES

- Dual-channel, 1024-position resolution
- 25 k Ω nominal resistance
- Low temperature coefficient: 35 ppm/ $^{\circ}$ C
- Nonvolatile memory stores wiper settings
- Permanent memory write protection
- Wiper setting readback
- Resistance tolerance stored in EEMEM
- Predefined linear increment/decrement instructions
- Predefined ± 6 dB/step log taper increment/decrement instructions
- SPI-compatible serial interface
- +2.7 V to +5 V single supply or ± 2.5 V dual supply
- 26 bytes extra nonvolatile memory for user-defined information
- 100-year typical data retention, $T_A = 55^{\circ}$ C
- Power-on refreshed with EEMEM settings
- Enhanced Features

- Supports defense and aerospace applications (AQEC)
- Temperature range: -40° C to $+125^{\circ}$ C
- Controlled manufacturing baseline
- 1 assembly/test site
- 1 fabrication site
- Product change notification
- Qualification data available on request

APPLICATIONS

- DWDM laser diode driver, optical supervisory systems
- Mechanical potentiometer replacement
- Instrumentation: gain, offset adjustment
- Programmable voltage-to-current conversion
- Programmable filters, delays, time constants
- Programmable power supply
- Low resolution DAC replacement
- Sensor calibration

GENERAL DESCRIPTION

The AD5235-EP is a dual-channel, nonvolatile memory,¹ digitally controlled potentiometer² with 1024-step resolution. The device performs the same electronic adjustment function as a mechanical potentiometer with enhanced resolution, solid state reliability, and superior low temperature coefficient performance. The AD5235-EP's versatile programming via an SPI[®]-compatible serial interface allows 16 modes of operation and adjustment including scratchpad programming, memory storing and restoring, increment/decrement, ± 6 dB/step log taper adjustment, wiper setting readback, and extra EEMEM¹ for user-defined information such as memory data for other components, look-up tables, or system identification information.

Rev. B

[Document Feedback](#)

Information furnished by Analog Devices is believed to be accurate and reliable. However, no responsibility is assumed by Analog Devices for its use, nor for any infringements of patents or other rights of third parties that may result from its use. Specifications subject to change without notice. No license is granted by implication or otherwise under any patent or patent rights of Analog Devices. Trademarks and registered trademarks are the property of their respective owners.

FUNCTIONAL BLOCK DIAGRAM

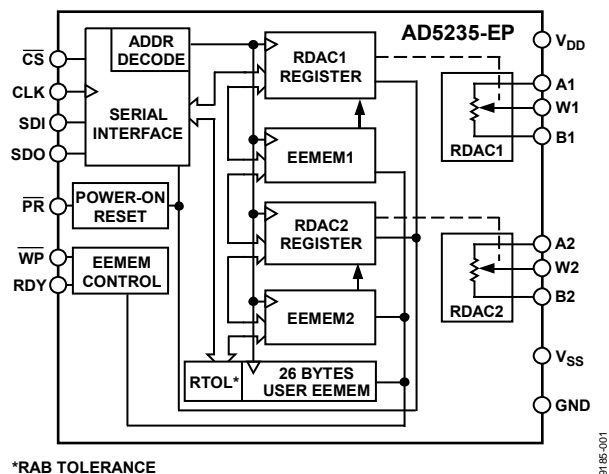

Figure 1.

In scratchpad programming mode, a specific setting can be programmed directly to the RDAC² register that sets the resistance between Terminal W and Terminal A, and Terminal W and Terminal B. This setting can be stored into the EEMEM and is restored automatically to the RDAC register during system power-on.

The EEMEM content can be restored dynamically or through external PR strobing, and a WP function protects EEMEM contents. To simplify the programming, the independent or simultaneous linear-step increment or decrement commands can be used to move the RDAC wiper up or down, one step at a time. For logarithmic ± 6 dB changes in the wiper setting, the left or right bit shift command can be used to double or halve the RDAC wiper setting.

The AD5235-EP patterned resistance tolerance is stored in the EEMEM. Therefore, in readback mode, the host processor can know the actual end-to-end resistance. The host can execute the appropriate resistance step through a software routine that simplifies open-loop applications as well as precision calibration and tolerance matching applications.

The AD5235-EP is available in a thin, 16-lead TSSOP package. The part is guaranteed to operate over the extended industrial temperature range of -40° C to $+125^{\circ}$ C.

Full details about this enhanced product, including theory of operation, register details, and applications information, are available in the [AD5235](#) data sheet, which should be consulted in conjunction with this data sheet.

¹ The terms nonvolatile memory and EEMEM are used interchangeably.

² The terms digital potentiometer and RDAC are used interchangeably.

TABLE OF CONTENTS

Features	1	Absolute Maximum Ratings	7
Applications.....	1	ESD Caution.....	7
General Description	1	Pin Configuration and Function Descriptions.....	8
Functional Block Diagram	1	Typical Performance Characteristics	9
Revision History	2	Test Circuits.....	13
Specifications.....	3	Outline Dimensions	14
Electrical Characteristics	3	Ordering Guide	14
Interface Timing and EEMEM Reliability Characteristics	5		

REVISION HISTORY

1/2018—Rev. A to Rev. B

Change to Features Section	1
Changes to Ordering Guide	14

7/2012—Rev. 0 to Rev. A

Change to Features Section	1
Changes to Electrical Characteristics Section and Table 1	3
Changes to Interface Timing and EEMEM Reliability Characteristics Section and Table 2	5
Changes to Typical Performance Characteristics Section.....	9
Added Figure 14 and Figure 16, Renumbered Sequentially	10
Deleted Figure 21.....	11
Added Figure 23.....	12

7/2010—Revision 0: Initial Version

SPECIFICATIONS

ELECTRICAL CHARACTERISTICS

$V_{DD} = 2.7 \text{ V to } 5.5 \text{ V}$, $V_{SS} = 0 \text{ V}$; $V_{DD} = 2.5 \text{ V}$, $V_{SS} = -2.5 \text{ V}$, $V_A = V_{DD}$, $V_B = V_{SS}$, $-40^\circ\text{C} < T_A < +125^\circ\text{C}$, unless otherwise noted.

Table 1.

Parameter	Symbol	Conditions	Min	Typ ¹	Max	Unit
DC CHARACTERISTICS—RHEOSTAT MODE (All RDACs)						
Resistor Differential Nonlinearity ²	R-DNL	R_{WB}	-1		+1	LSB
Resistor Integral Nonlinearity ²	R-INL	R_{WB}	-2		+2	LSB
Nominal Resistor Tolerance	$\Delta R_{AB}/R_{AB}$	Code = full-scale	-8		+8	%
Resistance Temperature Coefficient	$(\Delta R_{AB}/R_{AB})/\Delta T \times 10^6$			35		ppm/°C
Wiper Resistance	R_W	$I_W = 1 \text{ V}/R_{WB}$, $V_{DD} = 5 \text{ V}$, code = half scale		30	65	Ω
		$I_W = 1 \text{ V}/R_{WB}$, $V_{DD} = 3 \text{ V}$, code = half scale		50		Ω
Nominal Resistance Match	R_{AB1}/R_{AB2}	Code = full-scale, $T_A = 25^\circ\text{C}$		± 0.1		%
DC CHARACTERISTICS—POTENTIOMETER DIVIDER MODE (All RDACs)						
Resolution	N				10	Bits
Differential Nonlinearity ³	DNL		-1		+1	LSB
Integral Nonlinearity ³	INL		-1		+1	LSB
Voltage Divider Temperature Coefficient	$(\Delta V_W/V_W)/\Delta T \times 10^6$	Code = half scale		15		ppm/°C
Full-Scale Error	V_{WFSE}	Code = full-scale	-7		0	LSB
Zero-Scale Error	V_{WZSE}	Code = zero scale	0		5	LSB
RESISTOR TERMINALS						
Terminal Voltage Range ⁴	V_A, V_B, V_W		V_{SS}		V_{DD}	V
Capacitance A_x, B_x ⁵	C_A, C_B	$f = 1 \text{ MHz}$, measured to GND, code = half scale		11		pF
Capacitance W_x ⁵	C_W	$f = 1 \text{ MHz}$, measured to GND, code = half scale		80		pF
Common-Mode Leakage Current ^{5, 6}	I_{CM}	$V_W = V_{DD}/2$		0.01	± 1	μA
DIGITAL INPUTS AND OUTPUTS						
Input Logic High	V_{IH}	With respect to GND, $V_{DD} = 5 \text{ V}$	2.4			V
Input Logic Low	V_{IL}	With respect to GND, $V_{DD} = 5 \text{ V}$			0.8	V
Input Logic High	V_{IH}	With respect to GND, $V_{DD} = 3 \text{ V}$	2.1			V
Input Logic Low	V_{IL}	With respect to GND, $V_{DD} = 3 \text{ V}$			0.6	V
Input Logic High	V_{IH}	With respect to GND, $V_{DD} = +2.5 \text{ V}$, $V_{SS} = -2.5 \text{ V}$	2.0			V
Input Logic Low	V_{IL}	With respect to GND, $V_{DD} = +2.5 \text{ V}$, $V_{SS} = -2.5 \text{ V}$			0.5	V
Output Logic High (SDO, RDY)	V_{OH}	$R_{PULL-UP} = 2.2 \text{ k}\Omega$ to 5 V	4.9			V
Output Logic Low	V_{OL}	$I_{OL} = 1.6 \text{ mA}$, $V_{LOGIC} = 5 \text{ V}$			0.4	V
Input Current	I_{IL}	$V_{IN} = 0 \text{ V}$ or V_{DD}			± 2.25	μA
Input Capacitance ⁵	C_{IL}			5		pF

Parameter	Symbol	Conditions	Min	Typ ¹	Max	Unit
POWER SUPPLIES						
Single-Supply Power Range	V _{DD}	V _{SS} = 0 V	2.7		5.5	V
Dual-Supply Power Range	V _{DD} /V _{SS}		±2.25		±2.75	V
Positive Supply Current	I _{DD}	V _{IH} = V _{DD} or V _{IL} = GND		2	7	μA
Negative Supply Current	I _{SS}	V _{IH} = V _{DD} or V _{IL} = GND, V _{DD} = +2.5 V, V _{SS} = -2.5 V	-6	-2		μA
EEMEM Store Mode Current	I _{DD} (store)	V _{IH} = V _{DD} or V _{IL} = GND, V _{SS} = GND, I _{SS} ≈ 0		2		mA
EEMEM Restore Mode Current ⁷	I _{SS} (store)	V _{DD} = +2.5 V, V _{SS} = -2.5 V		-2		mA
	I _{DD} (restore)	V _{IH} = V _{DD} or V _{IL} = GND, V _{SS} = GND, I _{SS} ≈ 0		320		μA
	I _{SS} (restore)	V _{DD} = +2.5 V, V _{SS} = -2.5 V		-320		μA
Power Dissipation ⁸	P _{DISS}	V _{IH} = V _{DD} or V _{IL} = GND		10	40	μW
Power Supply Sensitivity ⁵	P _{SS}	ΔV _{DD} = 5 V ± 10%		0.006	0.01	%/%
DYNAMIC CHARACTERISTICS^{5, 9}						
Bandwidth	BW	-3 dB, V _{DD} /V _{SS} = ±2.5 V		125		kHz
Total Harmonic Distortion	THD _W	V _A = 1 V rms, V _B = 0 V, f = 1 kHz		0.009		%
V _W Settling Time	t _S	V _A = V _{DD} , V _B = 0 V, V _W = 0.50% error band, Code 0x000 to Code 0x200		4		μs
Resistor Noise Density	e _{N_WB}	T _A = 25°C		20		nV/√Hz
Crosstalk (C _{W1} /C _{W2})	C _T	V _A = V _{DD} , V _B = 0 V, measured V _{W1} with V _{W2} making full-scale change		30		nV-s
Analog Crosstalk	C _{TA}	V _{DD} = V _{A1} = +2.5 V, V _{SS} = V _{B1} = -2.5 V, measured V _{W1} with V _{W2} = 5 V p-p at f = 1 kHz, Code 1 = 0x200, Code 2 = 0x3FF		-110		dB

¹ Typicals represent average readings at 25°C and V_{DD} = 5 V.

² Resistor position nonlinearity error (R-INL) is the deviation from an ideal value measured between the maximum resistance and the minimum resistance wiper positions. R-DNL measures the relative step change from ideal between successive tap positions. I_W ~ 50 μA for V_{DD} = 2.7 V and I_W ~ 400 μA for V_{DD} = 5 V (see Figure 25).

³ INL and DNL are measured at V_W with the RDAC configured as a potentiometer divider similar to a voltage output DAC. V_A = V_{DD} and V_B = V_{SS}. DNL specification limits of ±1 LSB maximum are guaranteed monotonic operating conditions (see Figure 26).

⁴ Resistor Terminal A, Resistor Terminal B, and Resistor Terminal W have no limitations on polarity with respect to each other. Dual-supply operation enables ground-referenced bipolar signal adjustment.

⁵ Guaranteed by design and not subject to production test.

⁶ Common-mode leakage current is a measure of the dc leakage from any Terminal A, Terminal B, or Terminal W to a common-mode bias level of V_{DD}/2.

⁷ EEMEM restore mode current is not continuous. Current is consumed while EEMEM locations are read and transferred to the RDAC register (see Figure 22). To minimize power dissipation, a NOP, Instruction 0 (0x0) should be issued immediately after Instruction 1 (0x1).

⁸ P_{DISS} is calculated from (I_{DD} × V_{DD}) + (I_{SS} × V_{SS}).

⁹ All dynamic characteristics use V_{DD} = +2.5 V and V_{SS} = -2.5 V.

INTERFACE TIMING AND EEMEM RELIABILITY CHARACTERISTICS

Guaranteed by design and not subject to production test. See the Timing Diagrams section for the location of measured values. All input control voltages are specified with $t_R = t_F = 2.5$ ns (10% to 90% of 3 V) and timed from a voltage level of 1.5 V. Switching characteristics are measured using both $V_{DD} = 2.7$ V and $V_{DD} = 5$ V.

Table 2.

Parameter	Symbol	Conditions	Min	Typ ¹	Max	Unit
Clock Cycle Time (t_{CYC})	t_1		20			ns
\overline{CS} Setup Time	t_2		10			ns
CLK Shutdown Time to \overline{CS} Rise	t_3		1			t_{CYC}
Input Clock Pulse Width	t_4, t_5	Clock level high or low	10			ns
Data Setup Time	t_6	From positive CLK transition	5			ns
Data Hold Time	t_7	From positive CLK transition	5			ns
\overline{CS} to SDO-SPI Line Acquire	t_8				40	ns
\overline{CS} to SDO-SPI Line Release	t_9				50	ns
CLK to SDO Propagation Delay ²	t_{10}	$R_P = 2.2$ k Ω , $C_L < 20$ pF			50	ns
CLK to SDO Data Hold Time	t_{11}	$R_P = 2.2$ k Ω , $C_L < 20$ pF	0			ns
\overline{CS} High Pulse Width ³	t_{12}		10			ns
\overline{CS} High to \overline{CS} High ³	t_{13}		4			t_{CYC}
RDY Rise to \overline{CS} Fall	t_{14}		0			ns
\overline{CS} Rise to RDY Fall Time	t_{15}			0.15	0.3	ms
Store EEMEM Time ^{4, 5}	t_{16}	Applies to Instructions 0x2, 0x3		15	50	ms
Read EEMEM Time ⁴	t_{16}	Applies to Instructions 0x8, 0x9, 0x10		7	30	μ s
\overline{CS} Rise to Clock Rise/Fall Setup	t_{17}		10			ns
Preset Pulse Width (Asynchronous) ⁶	t_{PRW}		50			ns
Preset Response Time to Wiper Setting ⁶	t_{PRESP}	\overline{PR} pulsed low to refresh wiper positions		30		μ s
Power-On EEMEM Restore Time ⁶	t_{EEMEM}			30		μ s
FLASH/EE MEMORY RELIABILITY						
Endurance ⁷		$T_A = 25^\circ\text{C}$	100	1		MCycles kCycles
Data Retention ⁸				100		Years

¹ Typicals represent average readings at 25°C and $V_{DD} = 5$ V.

² Propagation delay depends on the value of V_{DD} , $R_{PULL-UP}$, and C_L .

³ Valid for commands that do not activate the RDY pin.

⁴ The RDY pin is low only for Instruction 2, Instruction 3, Instruction 8, Instruction 9, Instruction 10, and the \overline{PR} hardware pulse: CMD_8 ~ 20 μ s; CMD_9, CMD_10 ~ 7 μ s; CMD_2, CMD_3 ~ 15 ms; \overline{PR} hardware pulse ~ 30 μ s.

⁵ Store EEMEM time depends on the temperature and EEMEM writes cycles. Higher timing is expected at a lower temperature and higher write cycles.

⁶ Not shown in Figure 2 and Figure 3.

⁷ Endurance is qualified to 100,000 cycles per JEDEC Standard 22, Method A117 and measured at -40°C, +25°C, and +125°C.

⁸ Retention lifetime equivalent at junction temperature (T_J) = 85°C per JEDEC Standard 22, Method A117. Retention lifetime based on an activation energy of 1 eV derates with junction temperature in the Flash/EE memory.

Timing Diagrams

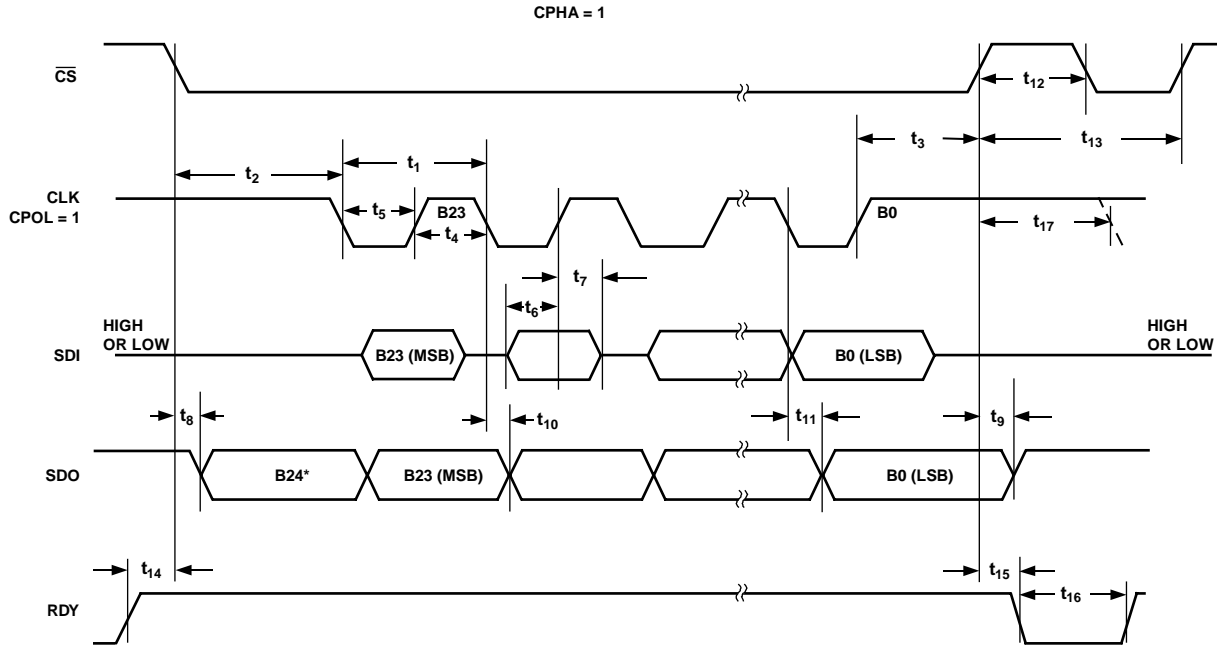

*THE EXTRA BIT THAT IS NOT DEFINED IS NORMALLY THE LSB OF THE CHARACTER PREVIOUSLY TRANSMITTED. THE CPOL = 1 MICROCONTROLLER COMMAND ALIGNS THE INCOMING DATA TO THE POSITIVE EDGE OF THE CLOCK.

Figure 2. CPHA = 1 Timing Diagram

09185-002

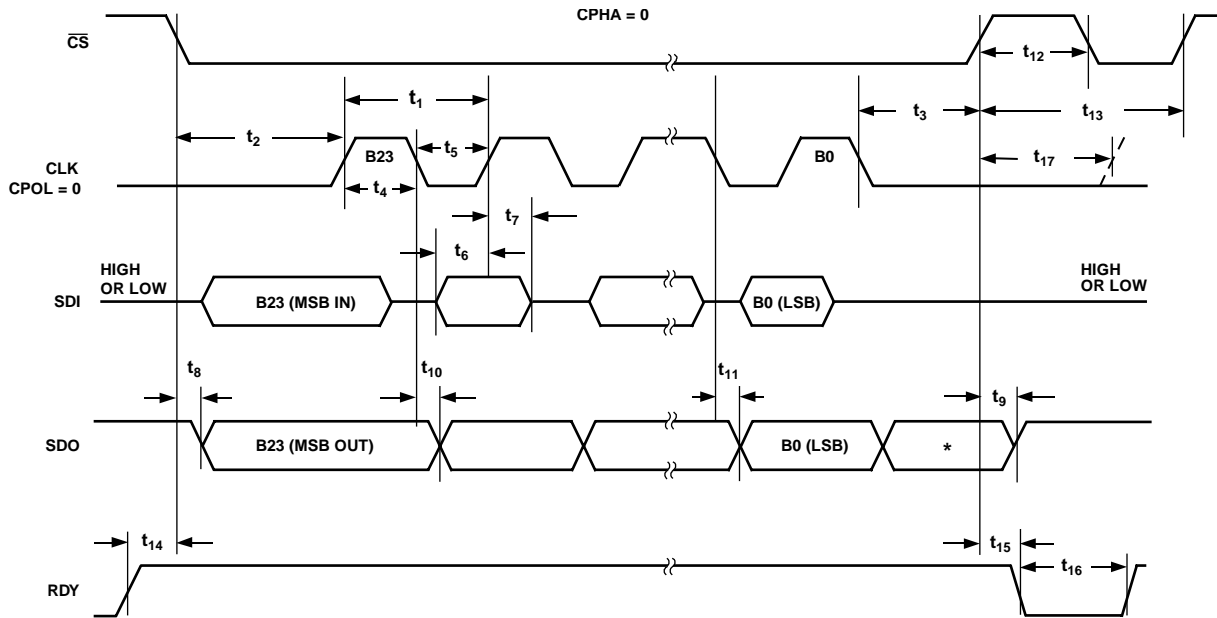

*THE EXTRA BIT THAT IS NOT DEFINED IS NORMALLY THE MSB OF THE CHARACTER JUST RECEIVED. THE CPOL = 0 MICROCONTROLLER COMMAND ALIGNS THE INCOMING DATA TO THE POSITIVE EDGE OF THE CLOCK.

Figure 3. CPHA = 0 Timing Diagram

09185-003

ABSOLUTE MAXIMUM RATINGS

$T_A = 25^\circ\text{C}$, unless otherwise noted.

Table 3.

Parameter	Rating
V_{DD} to GND	-0.3 V to +7 V
V_{SS} to GND	+0.3 V to -7 V
V_{DD} to V_{SS}	7 V
V_A, V_B, V_W to GND	$V_{SS} - 0.3 \text{ V}$ to $V_{DD} + 0.3 \text{ V}$
I_A, I_B, I_W	
Pulsed ¹	$\pm 2.5 \text{ mA}$
Continuous	$\pm 1.1 \text{ mA}$
Digital Input and Output Voltage to GND	-0.3 V to $V_{DD} + 0.3 \text{ V}$
Operating Temperature Range ²	-40°C to $+125^\circ\text{C}$
Maximum Junction Temperature ($T_J \text{ max}$)	150°C
Storage Temperature Range	-65°C to $+150^\circ\text{C}$
Lead Temperature, Soldering	
Vapor Phase (60 sec)	215°C
Infrared (15 sec)	220°C
Thermal Resistance	
Junction-to-Ambient, θ_{JA}	150°C/W
Junction-to-Case, θ_{JC}	28°C/W
Package Power Dissipation	$(T_J \text{ max} - T_A)/\theta_{JA}$

¹ Maximum terminal current is bounded by the maximum current handling of the switches, maximum power dissipation of the package and the maximum applied voltage across any two of the A, B, and W terminals at a given resistance.

² Includes programming of nonvolatile memory.

Stresses at or above those listed under Absolute Maximum Ratings may cause permanent damage to the product. This is a stress rating only; functional operation of the product at these or any other conditions above those indicated in the operational section of this specification is not implied. Operation beyond the maximum operating conditions for extended periods may affect product reliability.

ESD CAUTION



ESD (electrostatic discharge) sensitive device. Charged devices and circuit boards can discharge without detection. Although this product features patented or proprietary protection circuitry, damage may occur on devices subjected to high energy ESD. Therefore, proper ESD precautions should be taken to avoid performance degradation or loss of functionality.

PIN CONFIGURATION AND FUNCTION DESCRIPTIONS

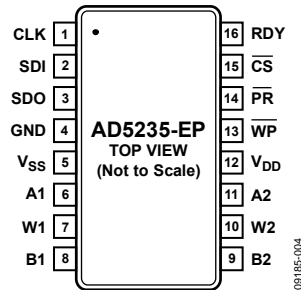

Figure 4. Pin Configuration

Table 4. Pin Function Descriptions

Pin No.	Mnemonic	Description
1	CLK	Serial Input Register Clock. Shifts in one bit at a time on positive clock edges.
2	SDI	Serial Data Input. Shifts in one bit at a time on positive clock CLK edges. MSB loads first.
3	SDO	Serial Data Output. Serves readback and daisy-chain functions. Command 9 and Command 10 activate the SDO output for the readback function, delayed by 24 or 25 clock pulses, depending on the clock polarity before and after the data-word (see Figure 2 and Figure 3). In other commands, the SDO shifts out the previously loaded SDI bit pattern, delayed by 24 or 25 clock pulses depending on the clock polarity (see Figure 2 and Figure 3). This previously shifted out SDI can be used for daisy-chaining multiple devices. Whenever SDO is used, a pull-up resistor in the range of 1 k Ω to 10 k Ω is needed.
4	GND	Ground Pin, Logic Ground Reference.
5	V _{SS}	Negative Supply. Connect to 0 V for single-supply applications. If V _{SS} is used in dual supply, it must be able to sink 35 mA for 30 ms when storing data to EEMEM.
6	A1	Terminal A of RDAC1.
7	W1	Wiper terminal of RDAC1. ADDR (RDAC1) = 0x0.
8	B1	Terminal B of RDAC1.
9	B2	Terminal B of RDAC2.
10	W2	Wiper terminal of RDAC2. ADDR (RDAC2) = 0x1.
11	A2	Terminal A of RDAC2.
12	V _{DD}	Positive Power Supply.
13	\overline{WP}	Optional Write Protect. When active low, \overline{WP} prevents any changes to the present contents, except \overline{PR} strobe. CMD_1 and COMD_8 refresh the RDAC register from EEMEM. Execute a NOP instruction before returning to \overline{WP} high. Tie \overline{WP} to V _{DD} , if not used.
14	\overline{PR}	Optional Hardware Override Preset. Refreshes the scratchpad register with current contents of the EEMEM register. Factory default loads midscale 512 ₁₀ until EEMEM is loaded with a new value by the user. \overline{PR} is activated at the logic high transition. Tie \overline{PR} to V _{DD} , if not used.
15	\overline{CS}	Serial Register Chip Select Active Low. Serial register operation takes place when \overline{CS} returns to logic high.
16	RDY	Ready. Active high open-drain output. Identifies completion of Instruction 2, Instruction 3, Instruction 8, Instruction 9, Instruction 10, and \overline{PR} .

TYPICAL PERFORMANCE CHARACTERISTICS

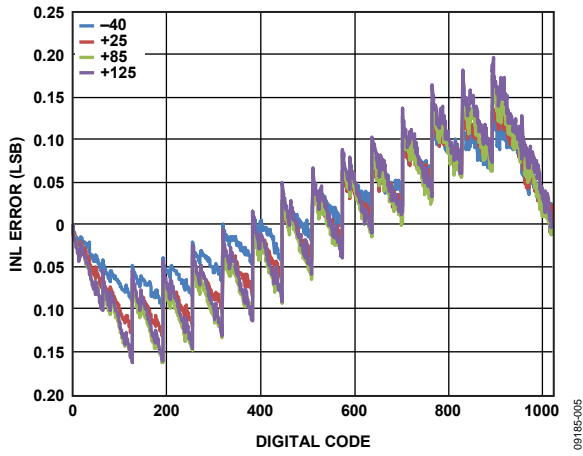

Figure 5. INL vs. Code, $T_A = -40^\circ\text{C}, +25^\circ\text{C}, +85^\circ\text{C}, +125^\circ\text{C}$ Overlay

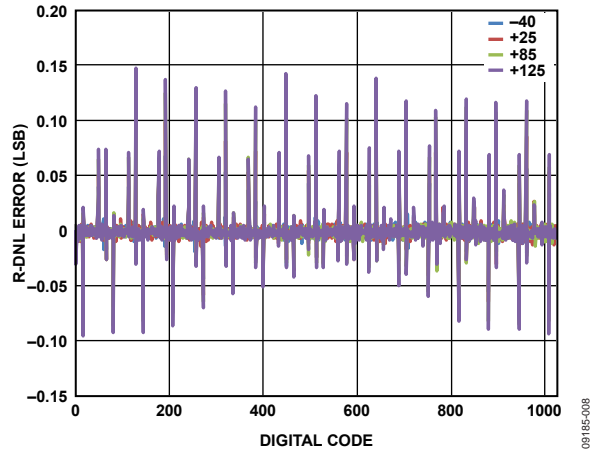

Figure 8. R-DNL vs. Code, $T_A = -40^\circ\text{C}, +25^\circ\text{C}, +85^\circ\text{C}, +125^\circ\text{C}$ Overlay

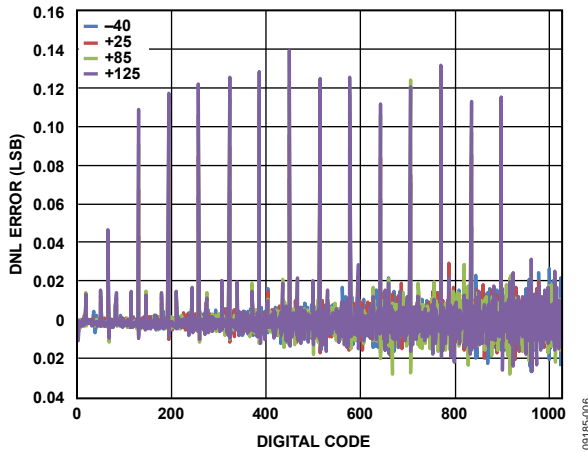

Figure 6. DNL vs. Code, $T_A = -40^\circ\text{C}, +25^\circ\text{C}, +85^\circ\text{C}, +125^\circ\text{C}$ Overlay

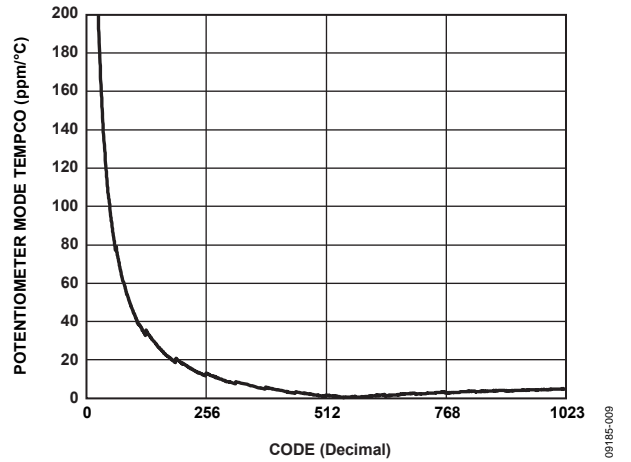

Figure 9. $(\Delta V_w/V_w)/\Delta T \times 10^6$ Potentiometer Mode Tempco

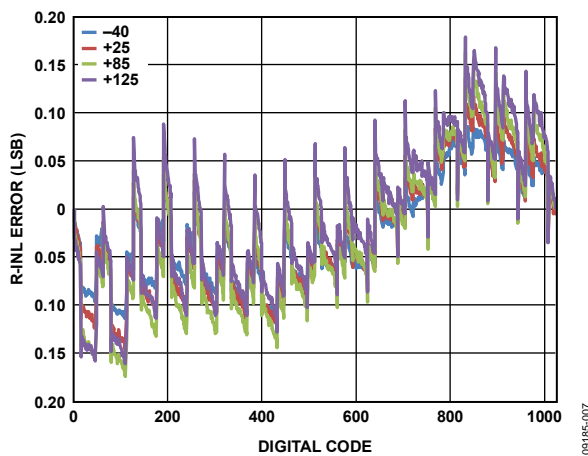

Figure 7. R-INL vs. Code, $T_A = -40^\circ\text{C}, +25^\circ\text{C}, +85^\circ\text{C}, +125^\circ\text{C}$ Overlay

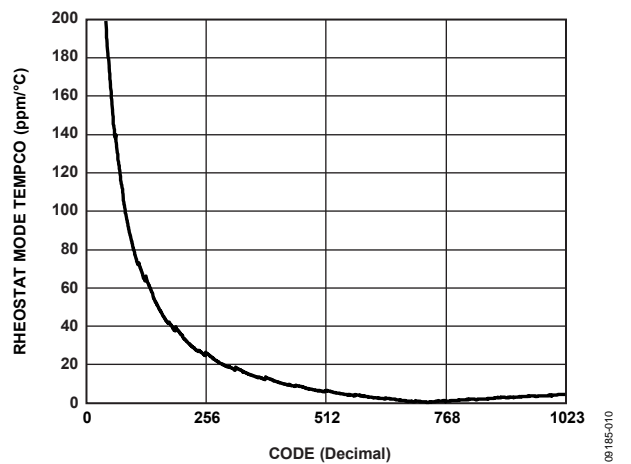

Figure 10. $(\Delta R_{WB}/R_{WB})/\Delta T \times 10^6$ Rheostat Mode Tempco

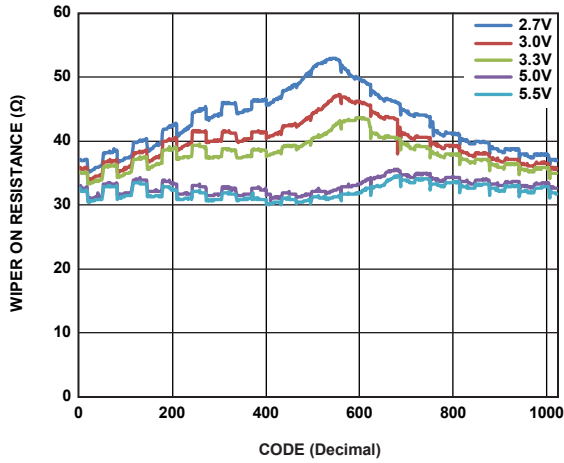

Figure 11. Wiper On Resistance vs. Code

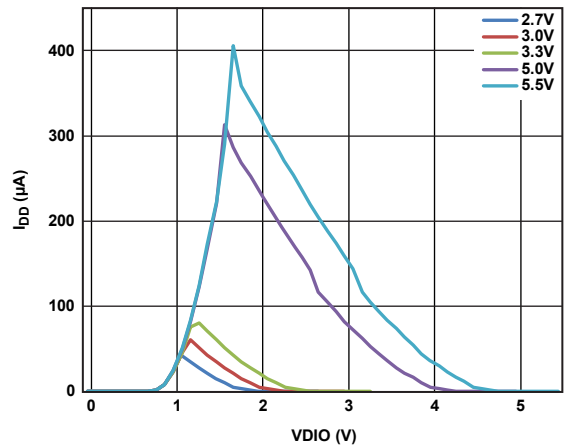

Figure 14. I_{DD} vs. Digital Input Voltage

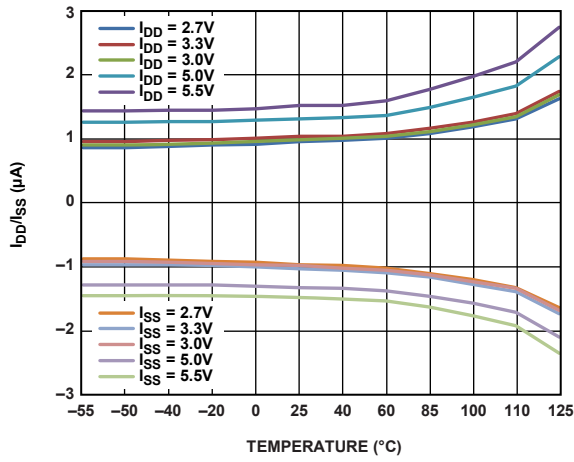

Figure 12. I_{DD} vs. Temperature

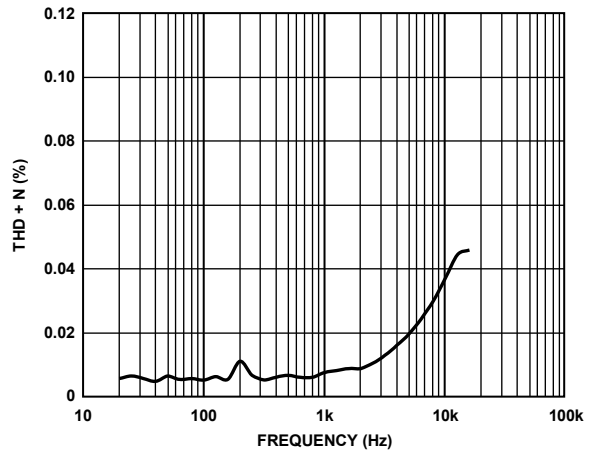

Figure 15. THD + Noise vs. Frequency

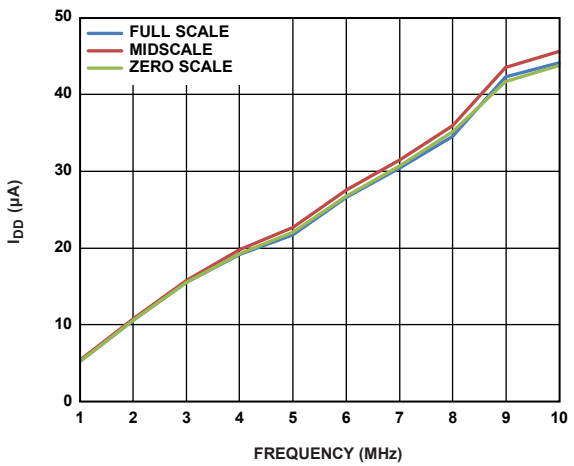

Figure 13. I_{DD} vs. Clock Frequency

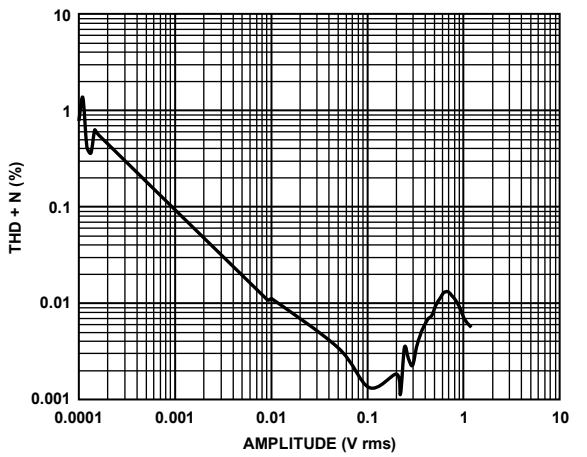

Figure 16. THD + Noise vs. Amplitude

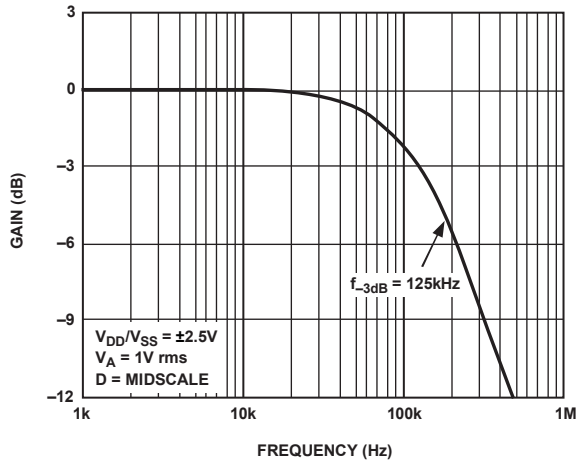

Figure 17. -3 dB Bandwidth vs. Resistance (See Figure 31)

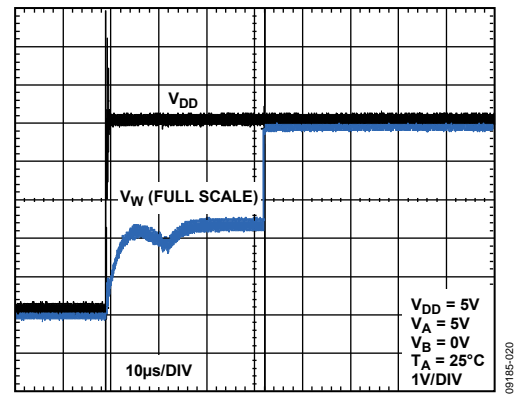

Figure 20. Power-On Reset

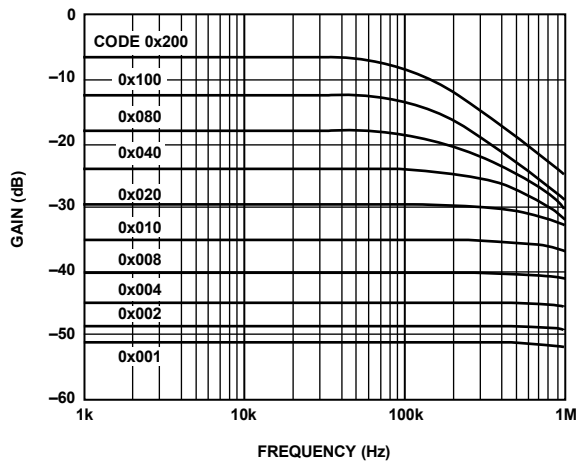

Figure 18. Gain vs. Frequency vs. Code (See Figure 31)

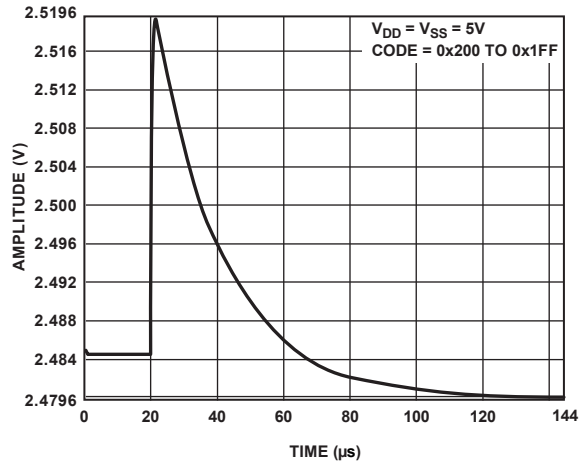

Figure 21. Midscale Glitch Energy

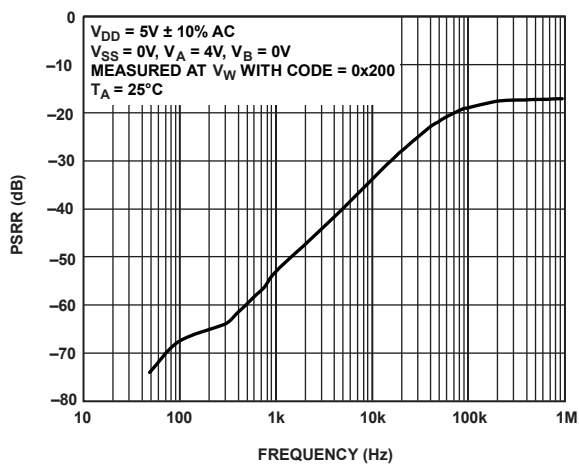

Figure 19. PSRR vs. Frequency

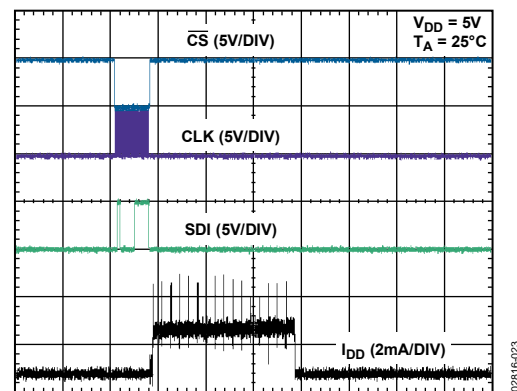

Figure 22. I_{DD} vs. Time When Storing Data to EEMEM

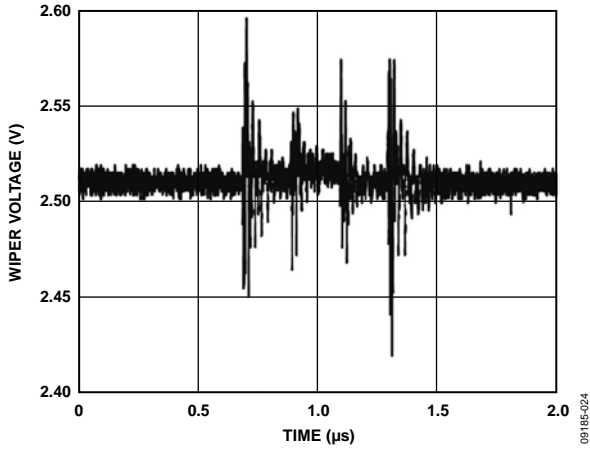

Figure 23. Digital Feedthrough

09185-024

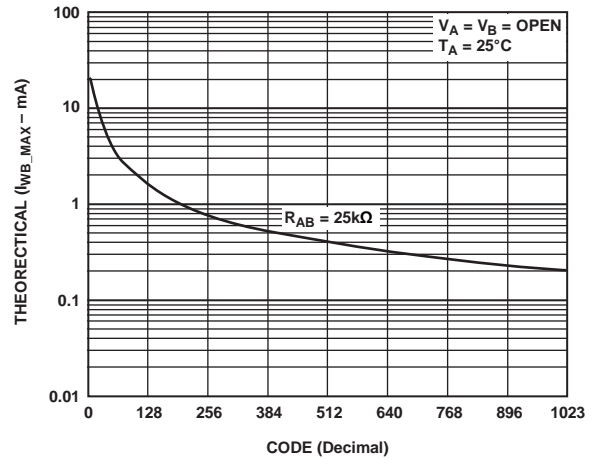

Figure 24. I_{WB_MAX} vs. Code

09185-125

TEST CIRCUITS

Figure 25 to Figure 35 define the test conditions used in the Specifications section.

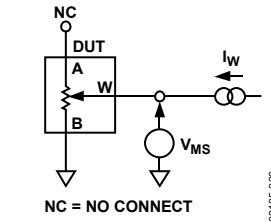

Figure 25. Resistor Position Nonlinearity Error (Rheostat Operation; R-INL, R-DNL)

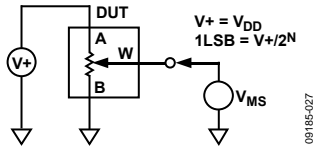

Figure 26. Potentiometer Divider Nonlinearity Error (INL, DNL)

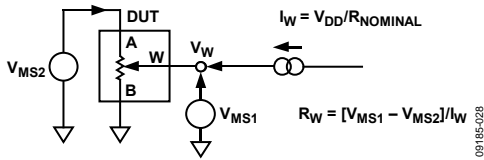

Figure 27. Wiper Resistance

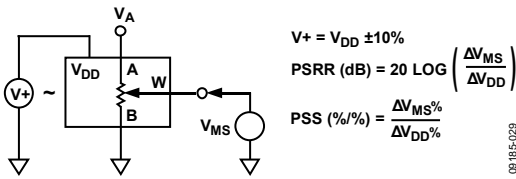

Figure 28. Power Supply Sensitivity (PSS, PSRR)

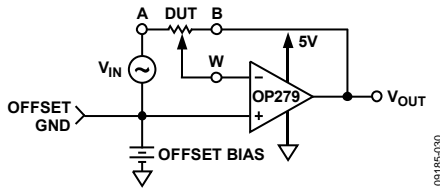

Figure 29. Inverting Gain

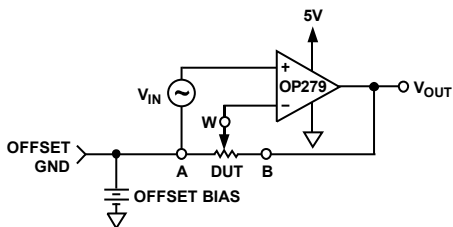

Figure 30. Noninverting Gain

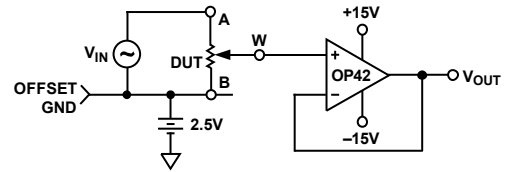

Figure 31. Gain vs. Frequency

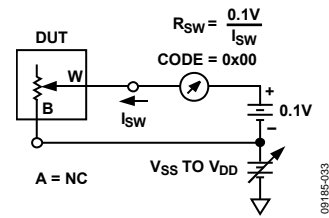

Figure 32. Incremental On Resistance

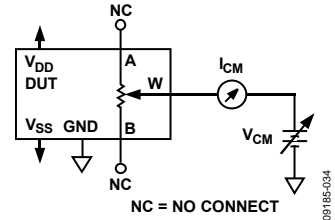

Figure 33. Common-Mode Leakage Current

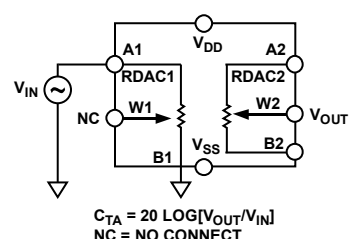

Figure 34. Analog Crosstalk

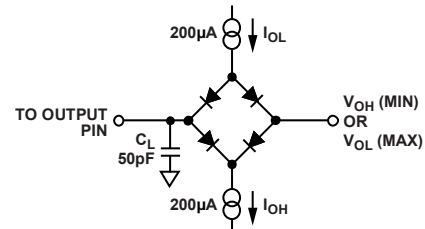
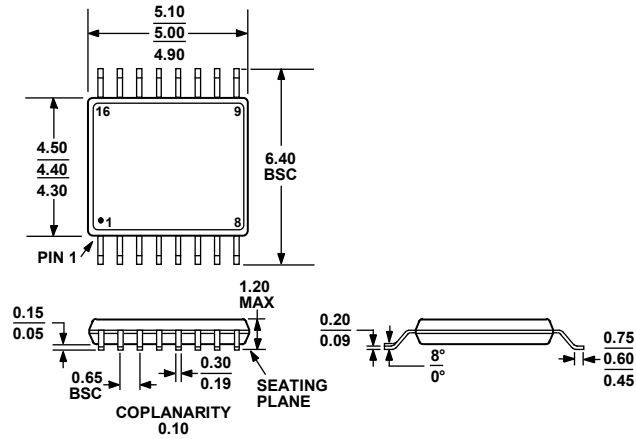

Figure 35. Load Circuit for Measuring V_{OH} and V_{OL} (The diode bridge test circuit is equivalent to the application circuit with $R_{PULL-UP}$ of 2.2 kΩ.)

OUTLINE DIMENSIONS



COMPLIANT TO JEDEC STANDARDS MO-153-AB

Figure 36. 16-Lead Thin Shrink Small Outline Package [TSSOP] (RU-16)

Dimensions shown in millimeters

ORDERING GUIDE

Model ¹	R _{AB} (kΩ)	Temperature Range	Package Description	Package Option
AD5235BRU25-EP-RL7	25	-40°C to +125°C	16-Lead Thin Shrink Small Outline Package [TSSOP]	RU-16
AD5235BRUZ25-EP-R7	25	-40°C to +125°C	16-Lead Thin Shrink Small Outline Package [TSSOP]	RU-16

¹ Z = RoHS Compliant Part.