

TEKNET



- ABS enclosure with new soft-touch contoured shape. By utilising multi-shot moulding technique, Teknet features an ergonomic design of elastomer grips (TPU) on the side of the case. Matt surface finish. Closing by four screws.

ACCESSORIES

Aluminium panel "APT.B.1".

COLOURS

.29 (Black / Dark gray), .30 (White / Light gray)

MODEL		DIMENSIONS mm.		
		L	W	H
↓	TN11.29	155.0	96.0	20.2
	TN11.30	155.0	96.0	20.2
↓	TN12.29	155.0	96.0	24.2
	TN12.30	155.0	96.0	24.2
↓	TN22.29	155.0	96.0	28.2
	TN22.30	155.0	96.0	28.2

[Download Acrobat ® PDF Drawing](#)

[back <](#)

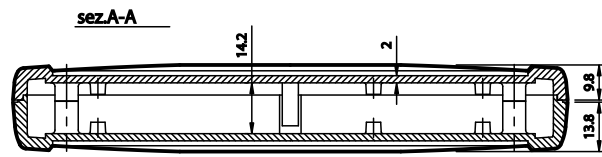
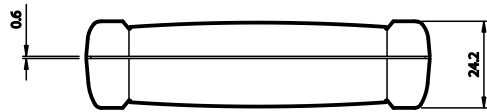
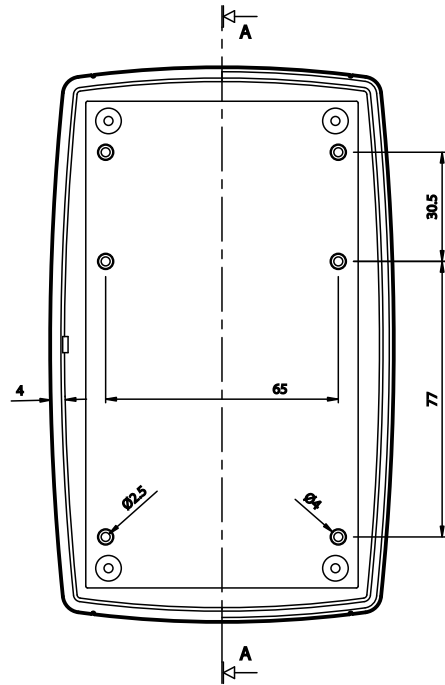
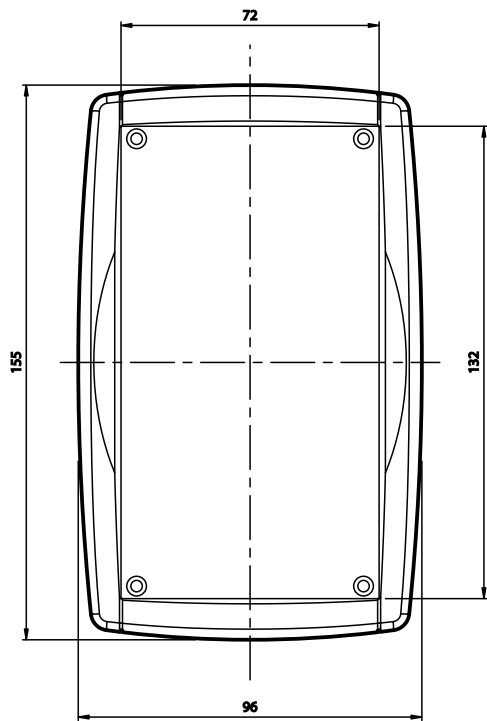

TN 12