

Series M .5" (12.7mm) Center-to-Center Spacing

Dual Row





Features:

- **Compact Modular Design for Low Power Circuits** – Suitable for surface connection applications using channel-assembled modular construction.
- **All-Surface Mountability** – Requires no additional insulation. Electro tin-coated steel mounting channel has two .196" diameter mounting holes.
- **Thermo-Set Phenolic Barrier-Type Terminal Blocks** – One thru 24 terminals on 1/2" center-to-center spacing.
- **Broad Choice of Terminal Connections** – Available in three screw designs and two .250" wide quick-connect variations offering up to four connections per terminal.
- **Wire Sizes** – M Series (No. 6-32 screw) is UL recognized for No. 22AWG to No. 14AWG. MA Series (No. 8-32 screw) is UL recognized for No. 22AWG to No. 12AWG. CSA requires lugs on wire larger than No. 14AWG for Series MA, and CSA requires lugs on No. 16AWG for Series M.
- **Current/Voltage Rating** – MA Series 25A/300V, M Series 15A/300V
- **Recognition and Listing** – Various terminal types are UL recognized and CSA certified.

TERMINAL DESIGNATIONS

- ***MA** 16-gauge (.051") brass terminal bar with two No. 8-32 plated steel screws per terminal accepting wire up to No. 12AWG
- ***MAQ** Four .250" x .032" brass quick-connect tabs per terminal accepting wire up to No. 12AWG
- ***MALQ** Two .250" x .032" brass quick-connect tabs and one No. 8-32 plated steel screw per terminal accepting wire up to No. 12AWG. Rated 25A/300V
- ***M** Brass terminal bar with two No. 6-32 plated steel screws per terminal accepting wire up to No. 14AWG
- ***MC** Brass terminal bar with two-piece No. 6-32 plated steel, captivated clamp assemblies per terminal accepting wire up to No. 14AWG

 Recognized under the Components Program of Underwriters Laboratories, Inc. Standard 1059, Guide No. XCFR2, File No. E62557.

 Guide No. 22.2 No. 158, Report No. LR39186-1.

Series M Variations

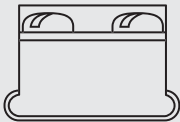

MA
terminal bar with two
No. 8-32 screws

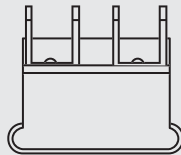

MAQ
four .250" side
quick-connects

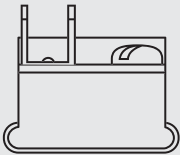

MALQ
two .250" wide quick-
connects and one
No. 8-32 screw

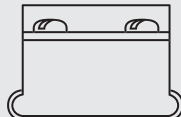

M
terminal bar with two No.
6-32 screws

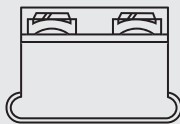

MC
terminal bar with two
captivated clamp assemblies

BARRIER STYLE

Specifications:**Center-to-Center Spacing:** .5" (12.7mm)**Wire Range:**

UL Recognized

MA - No. 22AWG to 12 AWG

M - No. 22 AWG to 14 AWG

CSA:

Must use lugs for wire larger than

MA - 12 AWG

M - 16 AWG

No. of Terminals: 1 thru 24**Voltage Rating:**

CSA – 300V

UL – 150V – General Industrial

250V – Commercial Appliance

Tightening Torque: 12 in.-lbs.**Current Rating:** UL and CSA: 15A (M), 25A (MA)**Housing:**

Material Phenolic

Continuous Use

Temp. (UL Index) 150°C (302°F)

Flammability Rating 94V-0

Water Absorption

(24 hrs. % wt. gain) .05%

Chemical Resistance Resistant to most organic solvents

Breakdown Voltage:

Terminal - Terminal 7,400V Typ.

Terminal - Ground 7,800V Typ.

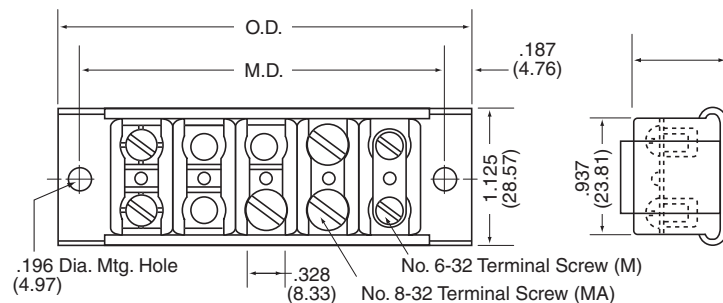
Note: Specifications contained herein are subject to change without notice.**Series M Dimensions**

NOTE: mm dim. are shown in parentheses

Series M Accessories**COVER**

Plain cover of 1/16" thick black bakelite with two mounting studs. Supplied loose for customer installation.

JUMPER

Brass jumper rates at 25 amps.

Part No. 258-A5

**How to Order**

M Series terminal blocks are ordered by listing a composite number made up of the model designation followed by the number of poles required for the application. Example: Type M 10-pole block becomes stock number M-10.

Number of Terminals	Mounting Dimensions		Overall Dimensions	
	Inches	Metric (mm)	Inches	Metric (mm)
1	1.000	25.40	1.375	34.92
2	1.500	38.10	1.875	47.62
3	2.000	50.80	2.375	60.32
4	2.500	63.50	2.875	73.00
5	3.000	76.20	3.375	85.72
6	3.500	88.90	3.875	98.42
7	4.000	101.60	4.375	111.12
8	4.500	114.30	4.875	123.82
9	5.000	127.00	5.387	136.52
10	5.500	139.70	5.875	149.22
11	6.000	152.40	6.375	161.92
12	6.500	165.10	6.875	174.62
13	7.000	177.80	7.375	187.32
14	7.500	190.50	7.875	200.02
15	8.000	203.20	8.375	212.72
16	8.500	215.90	8.875	225.42
17	9.000	228.60	9.375	238.12
18	9.500	241.30	9.875	250.82
19	10.000	254.00	10.375	263.52
20	10.500	266.70	10.875	276.22
21	11.000	279.40	11.375	288.92
22	11.500	292.10	11.875	301.62
23	12.000	304.80	12.375	314.32
24	12.500	317.50	12.875	327.02

Dimensions shown are ± 0.030 "