

# NCS2540

## Triple 750 MHz Voltage Feedback Op Amp with Enable Feature

NCS2540 is a triple 750 MHz voltage feedback monolithic operational amplifier featuring high slew rate and low differential gain and phase error. The voltage feedback architecture allows for a superior bandwidth and low power consumption. This device features an enable pin.

### Features

- -3.0 dB Small Signal BW ( $A_V = +2.0$ ,  $V_O = 0.5 V_{p-p}$ ) 750 MHz Typ
- Slew Rate 1700 V/ $\mu$ s
- Supply Current 13 mA/amp
- Input Referred Voltage Noise 5.0 nV/ $\sqrt{\text{Hz}}$
- THD -64 dBc ( $f = 5.0$  MHz,  $V_O = 2.0 V_{p-p}$ )
- Output Current 100 mA
- Enable Pin Available
- These are Pb-Free Devices

### Applications

- Line Drivers
- Radar/Communication Receivers

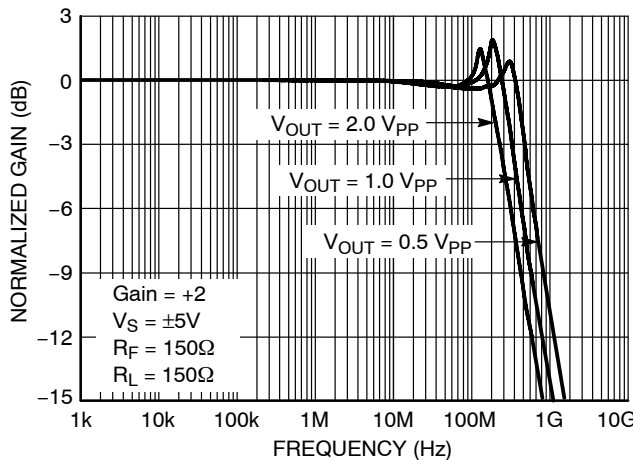

**Figure 1. Frequency Response:**  
Gain (dB) vs. Frequency  $A_V = +2.0$



**ON Semiconductor®**

<http://onsemi.com>

### MARKING DIAGRAM

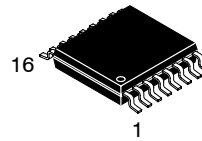

**TSSOP-16  
DT SUFFIX  
CASE 948F**

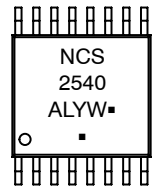

2540 = NCS2540  
A = Assembly Location  
L = Wafer Lot  
Y = Year  
W = Work Week  
▪ = Pb-Free Package  
(Note: Microdot may be in either location)

### TSSOP-16 PINOUT

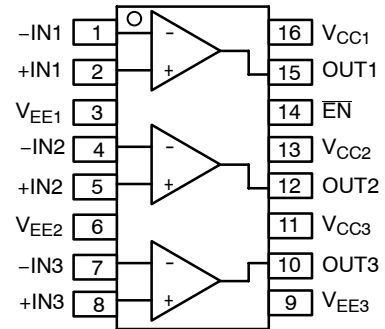

(Top View)

### ORDERING INFORMATION

Device	Package	Shipping†
NCS2540DTBG	TSSOP-16 (Pb-Free)	96 Units / Rail
NCS2540DTBR2G	TSSOP-16 (Pb-Free)	2500 / Tape & Reel

†For information on tape and reel specifications, including part orientation and tape sizes, please refer to our Tape and Reel Packaging Specification Brochure, BRD8011/D.

# NCS2540

## PIN FUNCTION DESCRIPTION

Pin	Symbol	Function	Equivalent Circuit
10, 12, 15	OUTx	Output	
3, 6, 9	VEE	Negative Power Supply	
2, 5, 8	+INx	Non-inverted Input	
1, 4, 7	-INx	Inverted Input	See Above
11, 13, 16	VCC	Positive Power Supply	
14	EN	Enable	

## ENABLE PIN TRUTH TABLE

	High	Low*
Enable	Disabled	Enabled

\*Default open state

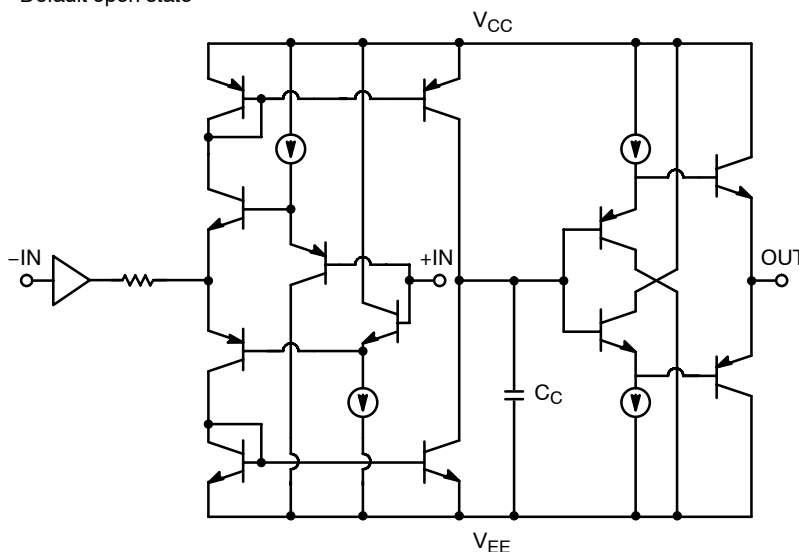

Figure 2. Simplified Device Schematic

# NCS2540

## ATTRIBUTES

Characteristics	Value
ESD	
Human Body Model	2.0 kV
Machine Model	200 V
Charged Device Model	1.0 kV
Moisture Sensitivity (Note 1)	Level 1
Flammability Rating    Oxygen Index: 28 to 34	UL 94 V-0 @ 0.125 in

1. For additional information, see Application Note AND8003/D.

## MAXIMUM RATINGS

Parameter	Symbol	Rating	Unit
Power Supply Voltage	$V_S$	11	Vdc
Input Voltage Range	$V_I$	$\leq V_S$	Vdc
Input Differential Voltage Range	$V_{ID}$	$\leq V_S$	Vdc
Output Current	$I_O$	100	mA
Maximum Junction Temperature (Note 2)	$T_J$	150	°C
Operating Ambient Temperature	$T_A$	-40 to +85	°C
Storage Temperature Range	$T_{stg}$	-60 to +150	°C
Power Dissipation	$P_D$	(See Graph)	mW
Thermal Resistance, Junction-to-Air	$R_{\theta JA}$	179	°C/W

Stresses exceeding Maximum Ratings may damage the device. Maximum Ratings are stress ratings only. Functional operation above the Recommended Operating Conditions is not implied. Extended exposure to stresses above the Recommended Operating Conditions may affect device reliability.

2. Power dissipation must be considered to ensure maximum junction temperature ( $T_J$ ) is not exceeded.

## MAXIMUM POWER DISSIPATION

The maximum power that can be safely dissipated is limited by the associated rise in junction temperature. For the plastic packages, the maximum safe junction temperature is 150°C. If the maximum is exceeded momentarily, proper circuit operation will be restored as soon as the die temperature is reduced. Leaving the device in the “overheated” condition for an extended period can result in device damage.

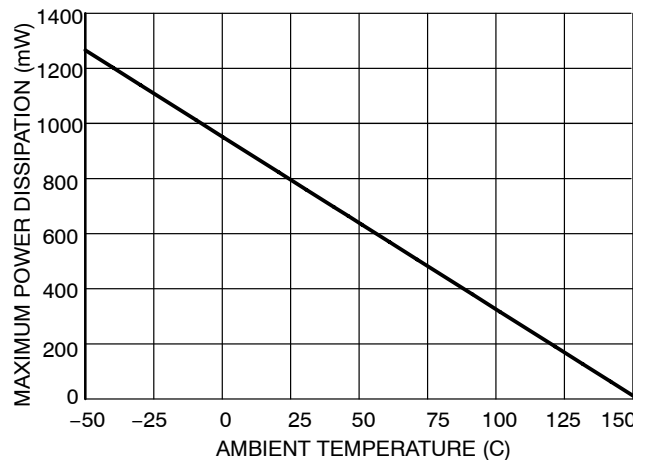

Figure 3. Power Dissipation vs. Temperature

# NCS2540

**AC ELECTRICAL CHARACTERISTICS** ( $V_{CC} = +5.0\text{ V}$ ,  $V_{EE} = -5.0\text{ V}$ ,  $T_A = -40^\circ\text{C}$  to  $+85^\circ\text{C}$ ,  $R_L = 150\ \Omega$  to GND,  $R_F = 150\ \Omega$ ,  $A_V = +2.0$ , Enable is left open, unless otherwise specified).

Symbol	Characteristic	Conditions	Min	Typ	Max	Unit
--------	----------------	------------	-----	-----	-----	------

## FREQUENCY DOMAIN PERFORMANCE

BW	Bandwidth 3.0 dB Small Signal 3.0 dB Large Signal	$A_V = +2.0$ , $V_O = 0.5\text{ V}_{p-p}$ $A_V = +2.0$ , $V_O = 2.0\text{ V}_{p-p}$		750 350		MHz
GF <sub>0.1dB</sub>	0.1 dB Gain Flatness Bandwidth	$A_V = +2.0$		40		MHz
dG	Differential Gain	$A_V = +2.0$ , $R_L = 150\ \Omega$ , $f = 3.58\text{ MHz}$		0.07		%
dP	Differential Phase	$A_V = +2.0$ , $R_L = 150\ \Omega$ , $f = 3.58\text{ MHz}$		0.01		°

## TIME DOMAIN RESPONSE

SR	Slew Rate	$A_V = +2.0$ , $V_{step} = 2.0\text{ V}$		1700		V/ $\mu\text{s}$
$t_s$	Settling Time 0.1%	$A_V = +2.0$ , $V_{step} = 2.0\text{ V}$		10		ns
$t_r$ , $t_f$	Rise and Fall Time	(10%–90%) $A_V = +2.0$ , $V_{step} = 2.0\text{ V}$		2.0		ns
$t_{ON}$	Turn-on Time			20		ns
$t_{OFF}$	Turn-off Time			40		ns

## HARMONIC/NOISE PERFORMANCE

THD	Total Harmonic Distortion	$f = 5.0\text{ MHz}$ , $V_O = 2.0\text{ V}_{p-p}$		-64		dB
HD2	2nd Harmonic Distortion	$f = 5.0\text{ MHz}$ , $V_O = 2.0\text{ V}_{p-p}$		-65		dBc
HD3	3rd Harmonic Distortion	$f = 5.0\text{ MHz}$ , $V_O = 2.0\text{ V}_{p-p}$		-75		dBc
IP3	Third-Order Intercept	$f = 10\text{ MHz}$ , $V_O = 1.0\text{ V}_{p-p}$		40		dBm
SFDR	Spurious-Free Dynamic Range	$f = 5.0\text{ MHz}$ , $V_O = 2.0\text{ V}_{p-p}$		65		dBc
$e_N$	Input Referred Voltage Noise	$f = 1.0\text{ MHz}$		5.0		nV/ $\sqrt{\text{Hz}}$
$i_N$	Input Referred Current Noise	$f = 1.0\text{ MHz}$		4.0		pA/ $\sqrt{\text{Hz}}$

# NCS2540

**DC ELECTRICAL CHARACTERISTICS** ( $V_{CC} = +5.0\text{ V}$ ,  $V_{EE} = -5.0\text{ V}$ ,  $T_A = -40^\circ\text{C}$  to  $+85^\circ\text{C}$ ,  $R_L = 150\ \Omega$  to GND,  $R_F = 150\ \Omega$ ,  $A_V = +2.0$ , Enable is left open, unless otherwise specified).

Symbol	Characteristic	Conditions	Min	Typ	Max	Unit
--------	----------------	------------	-----	-----	-----	------

## DC PERFORMANCE

$V_{IO}$	Input Offset Voltage (Note 3)		-10	0	+10	mV
$\Delta V_{IO}/\Delta T$	Input Offset Voltage Temperature Coefficient			6.0		$\mu\text{V}/^\circ\text{C}$
$I_{IB}$	Input Bias Current	$V_O = 0\text{ V}$		$\pm 3.2$	$\pm 20$	$\mu\text{A}$
$\Delta I_{IB}/\Delta T$	Input Bias Current Temperature Coefficient	$V_O = 0\text{ V}$		$\pm 40$		$\text{nA}/^\circ\text{C}$
$V_{IH}$	Input High Voltage (Enable) (Note 3)		3.0			V
$V_{IL}$	Input Low Voltage (Enable) (Note 3)				1.0	V

## INPUT CHARACTERISTICS

$V_{CM}$	Input Common Mode Voltage Range (Note 3)		$\pm 3.0$	$\pm 3.2$		V
CMRR	Common Mode Rejection Ratio (Note 3)	(See Graph)	40	50		dB
$R_{IN}$	Input Resistance			4.5		$\text{M}\Omega$
$C_{IN}$	Differential Input Capacitance			1.0		pF

## OUTPUT CHARACTERISTICS

$R_{OUT}$	Output Resistance			0.1		$\Omega$
$V_O$	Output Voltage Range		$\pm 3.0$	$\pm 4.0$		V
$I_O$	Output Current		$\pm 50$	$\pm 100$		mA

## POWER SUPPLY

$V_S$	Operating Voltage Supply			10		V
$I_{S,ON}$	Power Supply Current – Enabled per amplifier (Note 3)		5.0	13	17	mA
$I_{S,OFF}$	Power Supply Current – Disabled per amplifier			0.1	0.3	mA
PSRR	Power Supply Rejection Ratio (Note 3)	(See Graph)	40	56		dB
	Crosstalk	Channel to Channel, $f = 5\text{ MHz}$		85		dB

3. Guaranteed by design and/or characterization.

# NCS2540

**AC ELECTRICAL CHARACTERISTICS** ( $V_{CC} = +2.5\text{ V}$ ,  $V_{EE} = -2.5\text{ V}$ ,  $T_A = -40^\circ\text{C}$  to  $+85^\circ\text{C}$ ,  $R_L = 150\ \Omega$  to GND,  $R_F = 150\ \Omega$ ,  $A_V = +2.0$ , Enable is left open, unless otherwise specified).

Symbol	Characteristic	Conditions	Min	Typ	Max	Unit
--------	----------------	------------	-----	-----	-----	------

## FREQUENCY DOMAIN PERFORMANCE

BW	Bandwidth 3.0 dB Small Signal 3.0 dB Large Signal	$A_V = +2.0$ , $V_O = 0.5\text{ V}_{p-p}$ $A_V = +2.0$ , $V_O = 1.0\text{ V}_{p-p}$		550 200		MHz
GF <sub>0.1dB</sub>	0.1 dB Gain Flatness Bandwidth	$A_V = +2.0$		35		MHz
dG	Differential Gain	$A_V = +2.0$ , $R_L = 150\ \Omega$ , $f = 3.58\text{ MHz}$		0.07		%
dP	Differential Phase	$A_V = +2.0$ , $R_L = 150\ \Omega$ , $f = 3.58\text{ MHz}$		0.02		°

## TIME DOMAIN RESPONSE

SR	Slew Rate	$A_V = +2.0$ , $V_{step} = 1.0\text{ V}$		900		V/ $\mu\text{s}$
$t_s$	Settling Time 0.1%	$A_V = +2.0$ , $V_{step} = 1.0\text{ V}$		10		ns
$t_r$ , $t_f$	Rise and Fall Time	(10%–90%) $A_V = +2.0$ , $V_{step} = 1.0\text{ V}$		1.7		ns
$t_{ON}$	Turn-on Time			20		ns
$t_{OFF}$	Turn-off Time			40		ns

## HARMONIC/NOISE PERFORMANCE

THD	Total Harmonic Distortion	$f = 5.0\text{ MHz}$ , $V_O = 1.0\text{ V}_{p-p}$		-60		dB
HD2	2nd Harmonic Distortion	$f = 5.0\text{ MHz}$ , $V_O = 1.0\text{ V}_{p-p}$		-65		dBc
HD3	3rd Harmonic Distortion	$f = 5.0\text{ MHz}$ , $V_O = 1.0\text{ V}_{p-p}$		-63		dBc
IP3	Third-Order Intercept	$f = 10\text{ MHz}$ , $V_O = 0.5\text{ V}_{p-p}$		35		dBm
SFDR	Spurious-Free Dynamic Range	$f = 5.0\text{ MHz}$ , $V_O = 1.0\text{ V}_{p-p}$		63		dBc
$e_N$	Input Referred Voltage Noise	$f = 1.0\text{ MHz}$		5.0		nV/ $\sqrt{\text{Hz}}$
$i_N$	Input Referred Current Noise	$f = 1.0\text{ MHz}$		4.0		pA/ $\sqrt{\text{Hz}}$

# NCS2540

**DC ELECTRICAL CHARACTERISTICS** ( $V_{CC} = +2.5\text{ V}$ ,  $V_{EE} = -2.5\text{ V}$ ,  $T_A = -40^\circ\text{C}$  to  $+85^\circ\text{C}$ ,  $R_L = 150\ \Omega$  to GND,  $R_F = 150\ \Omega$ ,  $A_V = +2.0$ , Enable is left open, unless otherwise specified).

Symbol	Characteristic	Conditions	Min	Typ	Max	Unit
--------	----------------	------------	-----	-----	-----	------

## DC PERFORMANCE

$V_{IO}$	Input Offset Voltage (Note 4)		-10	0	+10	mV
$\Delta V_{IO}/\Delta T$	Input Offset Voltage Temperature Coefficient			6.0		$\mu\text{V}/^\circ\text{C}$
$I_{IB}$	Input Bias Current	$V_O = 0\text{ V}$		$\pm 3.2$	$\pm 20$	$\mu\text{A}$
$\Delta I_{IB}/\Delta T$	Input Bias Current Temperature Coefficient	$V_O = 0\text{ V}$		$\pm 40$		$\text{nA}/^\circ\text{C}$
$V_{IH}$	Input High Voltage (Enable) (Note 4)		1.5			V
$V_{IL}$	Input Low Voltage (Enable) (Note 4)				0.5	V

## INPUT CHARACTERISTICS

$V_{CM}$	Input Common Mode Voltage Range (Note 4)		$\pm 1.1$	$\pm 1.5$		V
CMRR	Common Mode Rejection Ratio (Note 4)	(See Graph)	40	50		dB
$R_{IN}$	Input Resistance			4.5		$\text{M}\Omega$
$C_{IN}$	Differential Input Capacitance			1.0		pF

## OUTPUT CHARACTERISTICS

$R_{OUT}$	Output Resistance			0.1		$\Omega$
$V_O$	Output Voltage Range		$\pm 1.1$	$\pm 1.5$		V
$I_O$	Output Current		$\pm 50$	$\pm 100$		mA

## POWER SUPPLY

$V_S$	Operating Voltage Supply			5.0		V
$I_{S,ON}$	Power Supply Current – Enabled per amplifier		5.0	11	17	mA
$I_{S,OFF}$	Power Supply Current – Disabled per amplifier			0.1	0.3	mA
PSRR	Power Supply Rejection Ratio (Note 4)	(See Graph)	40	56		dB
	Crosstalk	Channel to Channel, $f = 5\text{ MHz}$		85		dB

4. Guaranteed by design and/or characterization.

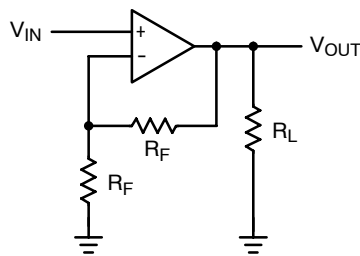

**Figure 4. Typical Test Setup**  
( $A_V = +2.0$ ,  $R_F = 150\text{ k}\Omega$ ,  $R_L = 150\ \Omega$ )

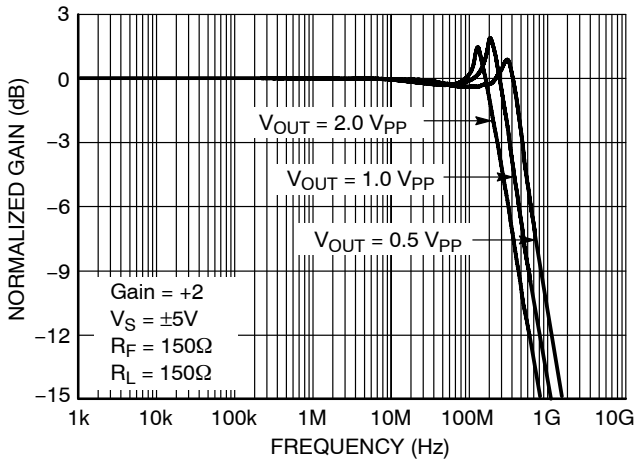

**Figure 5. Frequency Response:**  
Gain (dB) vs. Frequency  
Av = +2.0

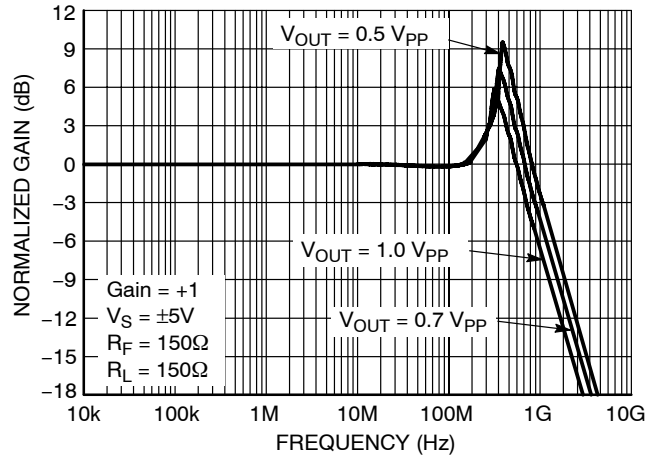

**Figure 6. Frequency Response:**  
Gain (dB) vs. Frequency  
Av = +1.0

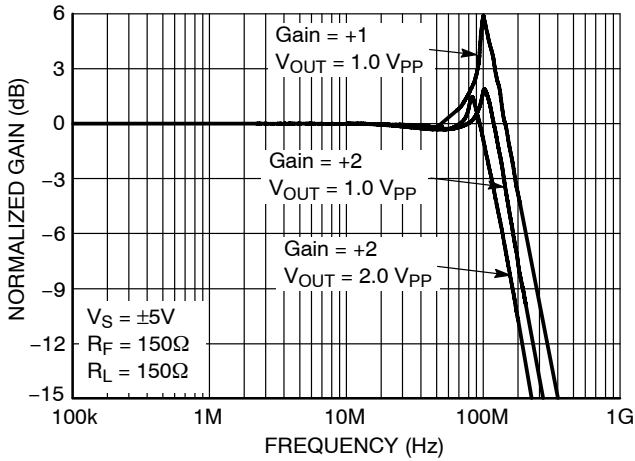

**Figure 7. Large Signal Frequency Response**  
Gain (dB) vs. Frequency

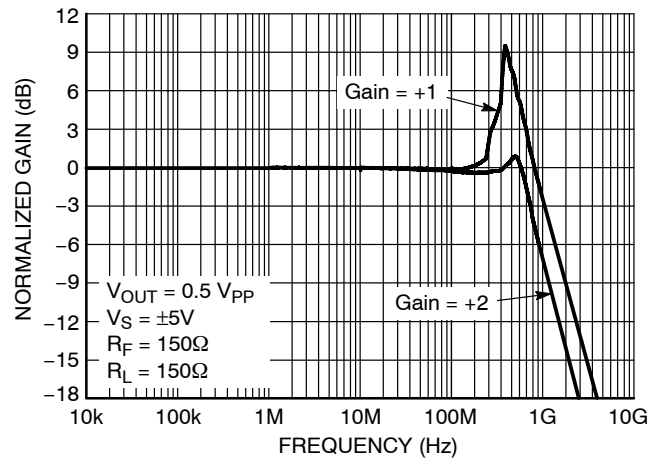

**Figure 8. Small Signal Frequency Response**  
Gain (dB) vs. Frequency

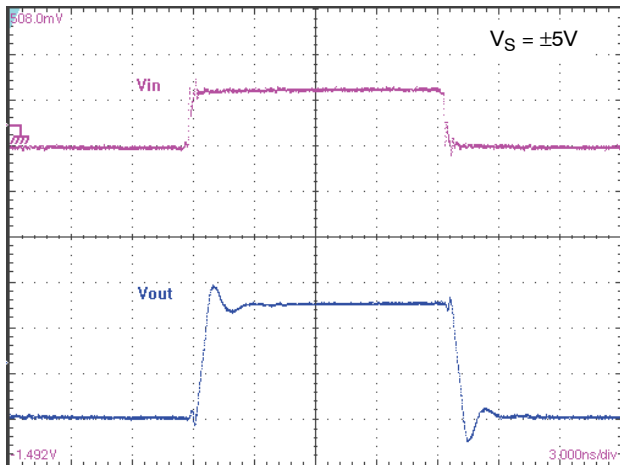

**Figure 9. Small Signal Step Response**  
Vertical: 20 mV/div  
Horizontal: 3 ns/div

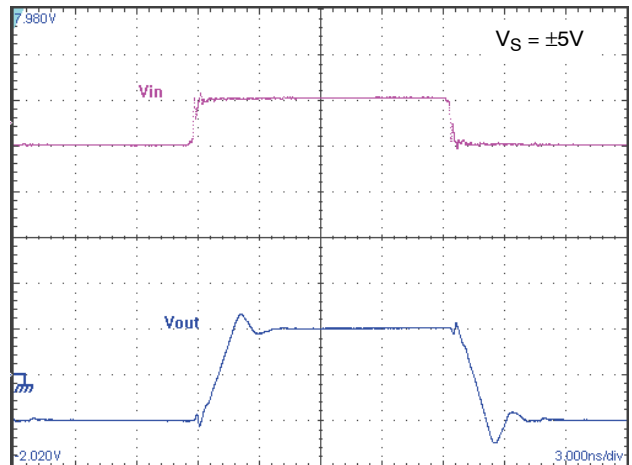

**Figure 10. Large Signal Step Response**  
Vertical: 1 V/div  
Horizontal: 3 ns/div



# NCS2540

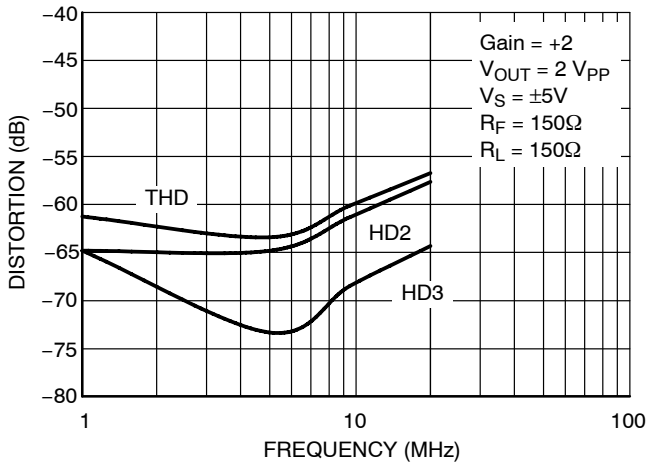

Figure 11. THD, HD2, HD3 vs. Frequency

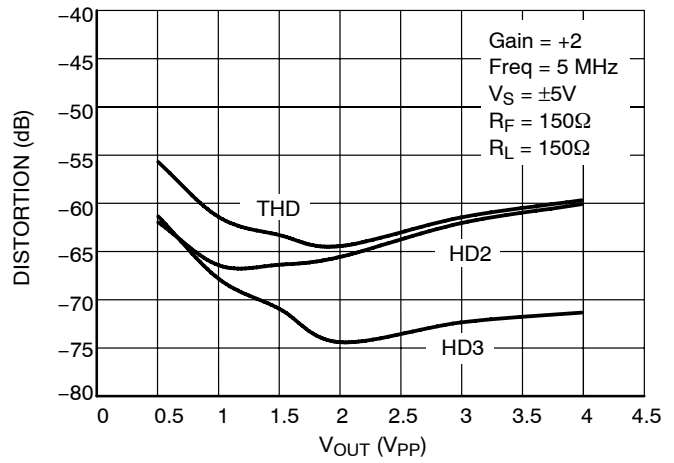

Figure 12. THD, HD2, HD3 vs. Output Voltage

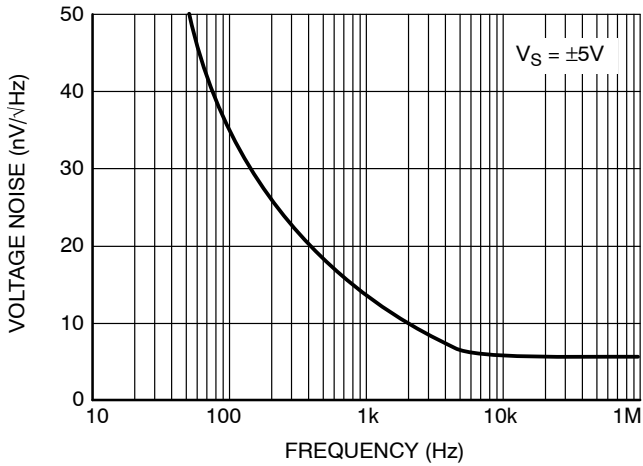

Figure 13. Input Referred Voltage Noise vs. Frequency

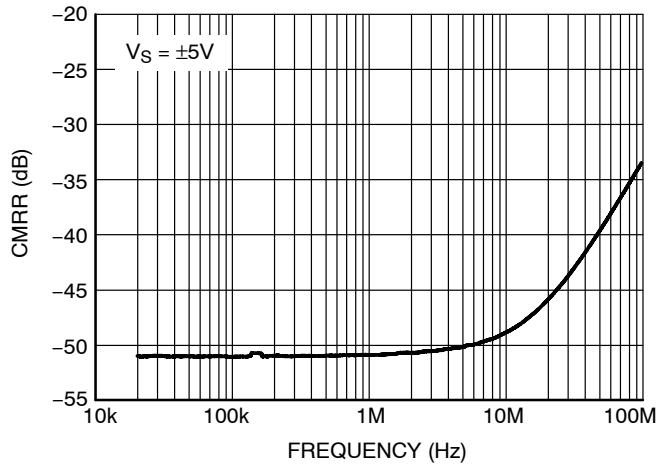

Figure 14. CMRR vs. Frequency

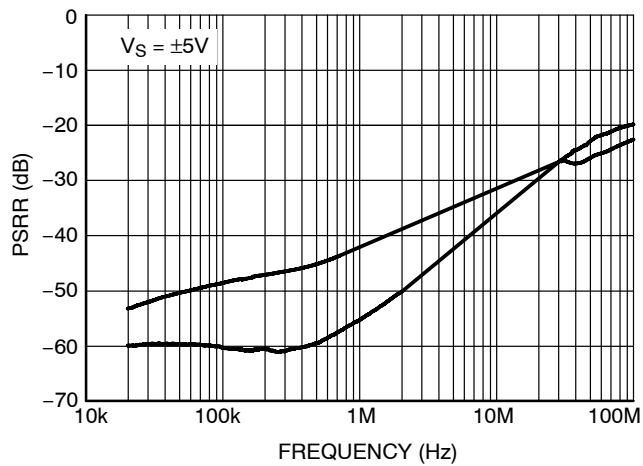

Figure 15. PSRR vs. Frequency

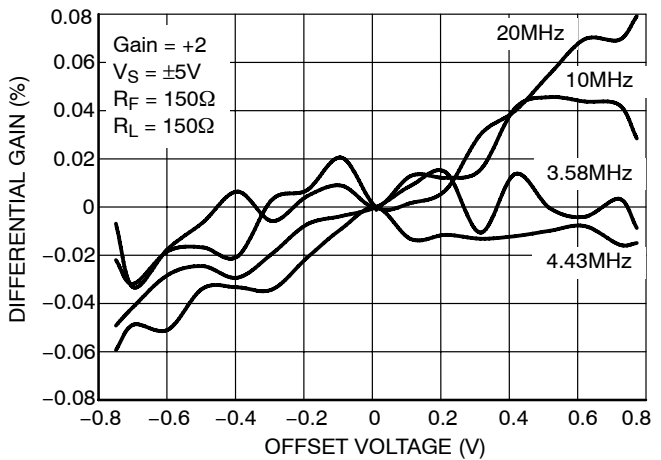

Figure 16. Differential Gain

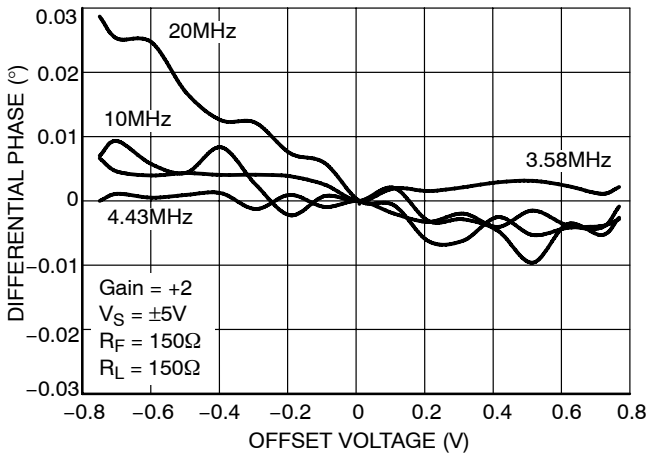

Figure 17. Differential Phase

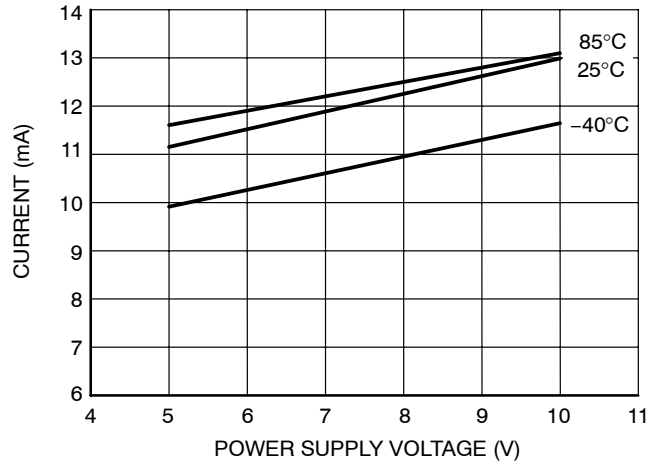

Figure 18. Supply Current Per Amplifier vs. Power Supply (Enabled)

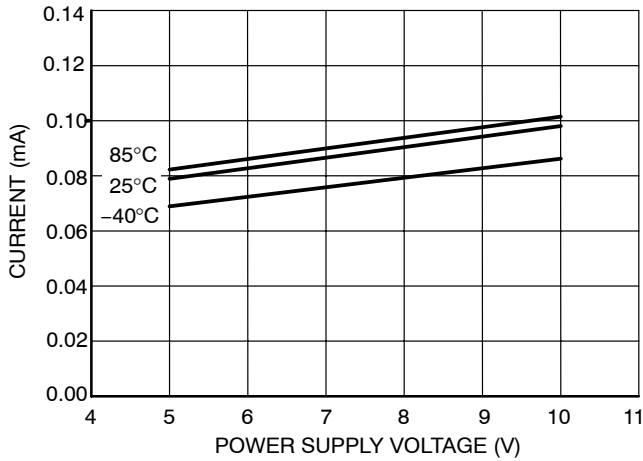

Figure 19. Supply Current Per Amplifier vs. Temperature (Disabled)

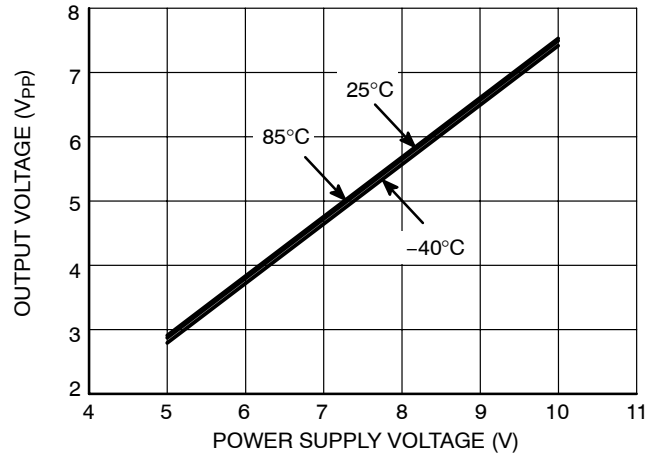

Figure 20. Output Voltage Swing vs. Supply Voltage

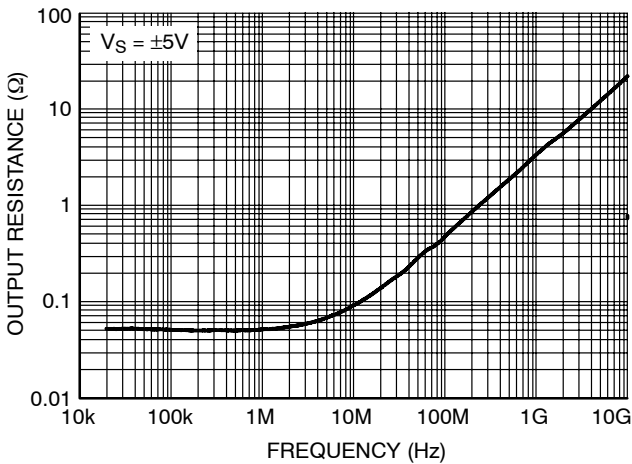

Figure 21. Output Resistance vs. Frequency

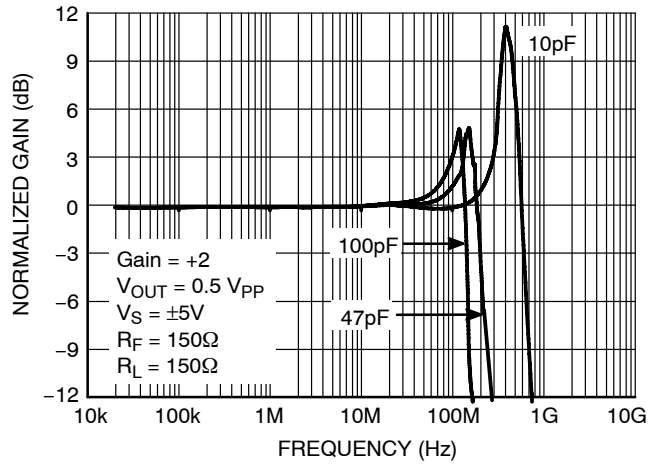
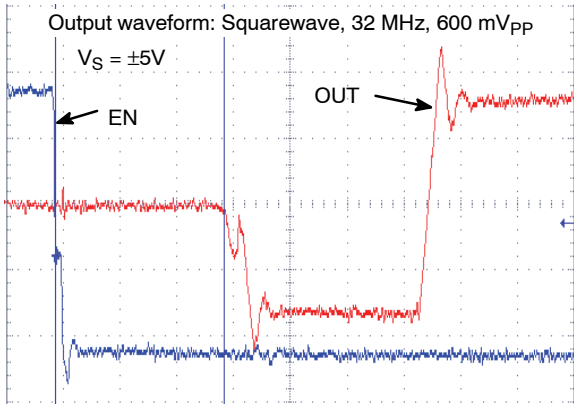
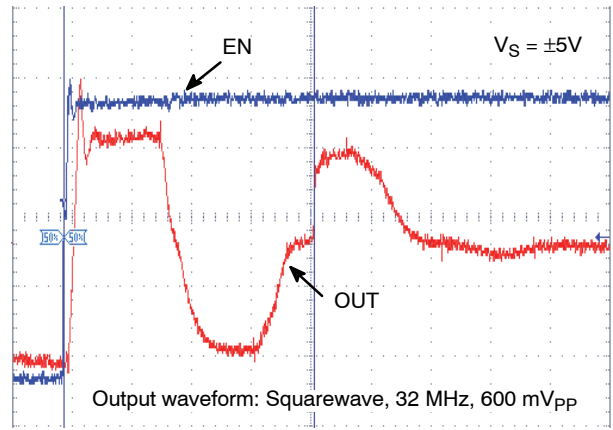

Figure 22. Frequency Response vs. Capacitive Load



**Figure 23. Turn ON Time Delay**  
 Vertical: 500 mV/div (Enable), 200 mV/div (Output)  
 Horizontal: 5 ns/div



**Figure 24. Turn OFF Time Delay**  
 Vertical: 500 mV/div (Enable), 200 mV/div (Output)  
 Horizontal: 10 ns/div

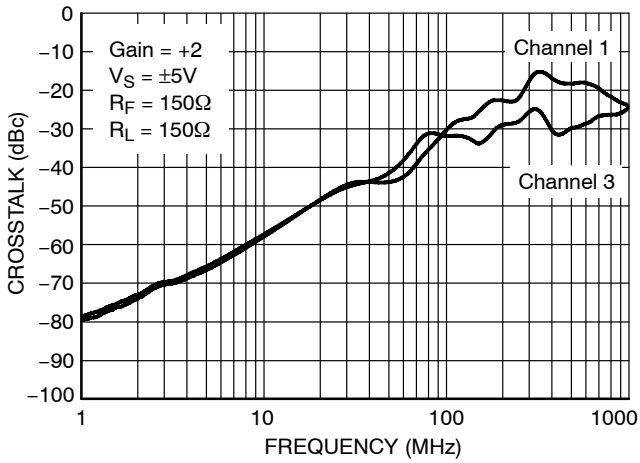

**Figure 25. Crosstalk vs Frequency**  
 (Crosstalk measured on Channel 2 with input signal on Channel 1 and 3)

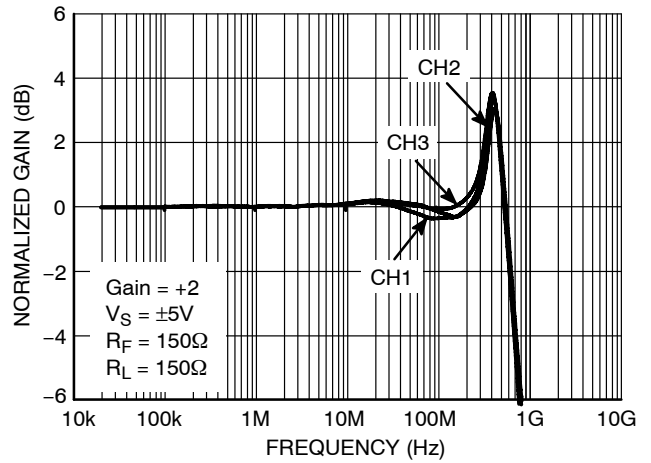

**Figure 26. Channel Matching (dB) vs Frequency**

**Printed Circuit Board Layout Techniques**

Proper high speed PCB design rules should be used for all wideband amplifiers as the PCB parasitics can affect the overall performance. Most important are stray capacitances at the output and inverting input nodes as it can effect peaking and bandwidth. A space (3/16" is plenty) should be left around the signal lines to minimize coupling. Also, signal lines connecting the feedback and gain resistors should be short enough so that their associated inductance does not cause high frequency gain errors. Line lengths less than 1/4" are recommended.

**Video Performance**

This device designed to provide good performance with NTSC, PAL, and HDTV video signals. Best performance is obtained with back terminated loads as performance is degraded as the load is increased. The back termination reduces reflections from the transmission line and effectively masks transmission line and other parasitic capacitances from the amplifier output stage.

**ESD Protection**

All device pins have limited ESD protection using internal diodes to power supplies as specified in the attributes table (see Figure 27). These diodes provide moderate protection

to input overdrive voltages above the supplies. The ESD diodes can support high input currents with current limiting series resistors. Keep these resistor values as low as possible since high values degrade both noise performance and frequency response. Under closed-loop operation, the ESD diodes have no effect on circuit performance. However, under certain conditions the ESD diodes will be evident. If the device is driven into a slewing condition, the ESD diodes will clamp large differential voltages until the feedback loop restores closed-loop operation. Also, if the device is powered down and a large input signal is applied, the ESD diodes will conduct.

NOTE: Human Body Model for +IN and -IN pins are rated at 0.8kV while all other pins are rated at 2.0kV.

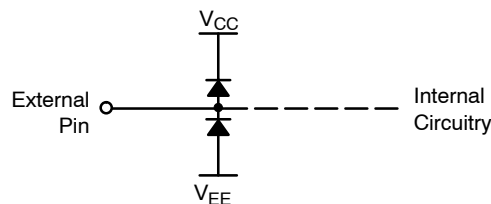
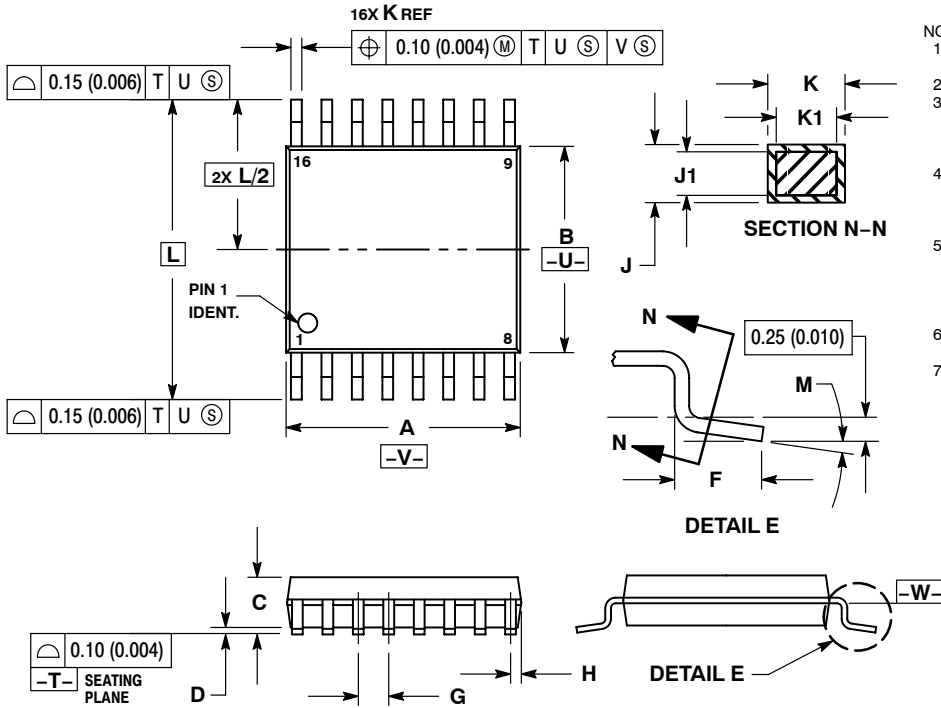

**Figure 27. Internal ESD Protection**

# NCS2540

## PACKAGE DIMENSIONS

TSSOP-16  
CASE 948F-01  
ISSUE B



NOTES:

1. DIMENSIONING AND TOLERANCING PER ANSI Y14.5M, 1982.
2. CONTROLLING DIMENSION: MILLIMETER.
3. DIMENSION A DOES NOT INCLUDE MOLD FLASH. PROTRUSIONS OR GATE BURRS. MOLD FLASH OR GATE BURRS SHALL NOT EXCEED 0.15 (0.006) PER SIDE.
4. DIMENSION B DOES NOT INCLUDE INTERLEAD FLASH OR PROTRUSION. INTERLEAD FLASH OR PROTRUSION SHALL NOT EXCEED 0.25 (0.010) PER SIDE.
5. DIMENSION K DOES NOT INCLUDE DAMBAR PROTRUSION. ALLOWABLE DAMBAR PROTRUSION SHALL BE 0.08 (0.003) TOTAL IN EXCESS OF THE K DIMENSION AT MAXIMUM MATERIAL CONDITION.
6. TERMINAL NUMBERS ARE SHOWN FOR REFERENCE ONLY.
7. DIMENSION A AND B ARE TO BE DETERMINED AT DATUM PLANE -W-.

DIM	MILLIMETERS		INCHES	
	MIN	MAX	MIN	MAX
A	4.90	5.10	0.193	0.200
B	4.30	4.50	0.169	0.177
C	---	1.20	---	0.047
D	0.05	0.15	0.002	0.006
F	0.50	0.75	0.020	0.030
G	0.65 BSC		0.026 BSC	
H	0.18	0.28	0.007	0.011
J	0.09	0.20	0.004	0.008
J1	0.09	0.16	0.004	0.006
K	0.19	0.30	0.007	0.012
K1	0.19	0.25	0.007	0.010
L	6.40 BSC		0.252 BSC	
M	0°	8°	0°	8°

### SOLDERING FOOTPRINT\*

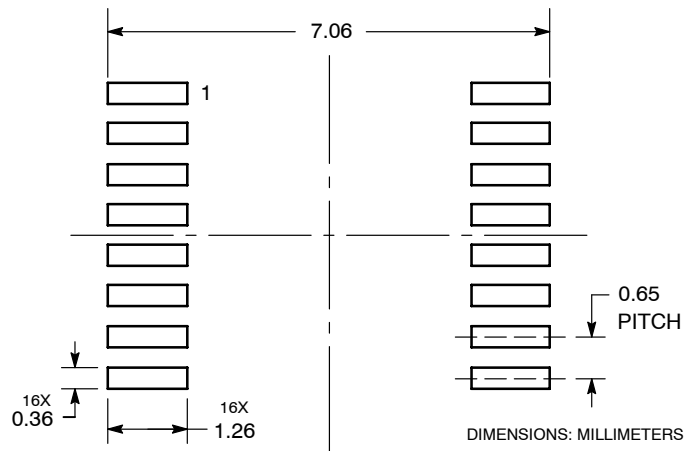

\*For additional information on our Pb-Free strategy and soldering details, please download the ON Semiconductor Soldering and Mounting Techniques Reference Manual, SOLDERRM/D.

**ON Semiconductor** and  are registered trademarks of Semiconductor Components Industries, LLC (SCILLC). SCILLC reserves the right to make changes without further notice to any products herein. SCILLC makes no warranty, representation or guarantee regarding the suitability of its products for any particular purpose, nor does SCILLC assume any liability arising out of the application or use of any product or circuit, and specifically disclaims any and all liability, including without limitation special, consequential or incidental damages. "Typical" parameters which may be provided in SCILLC data sheets and/or specifications can and do vary in different applications and actual performance may vary over time. All operating parameters, including "Typicals" must be validated for each customer application by customer's technical experts. SCILLC does not convey any license under its patent rights nor the rights of others. SCILLC products are not designed, intended, or authorized for use as components in systems intended for surgical implant into the body, or other applications intended to support or sustain life, or for any other application in which the failure of the SCILLC product could create a situation where personal injury or death may occur. Should Buyer purchase or use SCILLC products for any such unintended or unauthorized application, Buyer shall indemnify and hold SCILLC and its officers, employees, subsidiaries, affiliates, and distributors harmless against all claims, costs, damages, and expenses, and reasonable attorney fees arising out of, directly or indirectly, any claim of personal injury or death associated with such unintended or unauthorized use, even if such claim alleges that SCILLC was negligent regarding the design or manufacture of the part. SCILLC is an Equal Opportunity/Affirmative Action Employer. This literature is subject to all applicable copyright laws and is not for resale in any manner.

## PUBLICATION ORDERING INFORMATION

### LITERATURE FULFILLMENT:

Literature Distribution Center for ON Semiconductor  
P.O. Box 5163, Denver, Colorado 80217 USA  
**Phone:** 303-675-2175 or 800-344-3860 Toll Free USA/Canada  
**Fax:** 303-675-2176 or 800-344-3867 Toll Free USA/Canada  
**Email:** [orderlit@onsemi.com](mailto:orderlit@onsemi.com)

**N. American Technical Support:** 800-282-9855 Toll Free  
USA/Canada  
**Europe, Middle East and Africa Technical Support:**  
Phone: 421 33 790 2910  
**Japan Customer Focus Center**  
Phone: 81-3-5773-3850

**ON Semiconductor Website:** [www.onsemi.com](http://www.onsemi.com)

**Order Literature:** <http://www.onsemi.com/orderlit>

For additional information, please contact your local  
Sales Representative