



Power Silicon Rectifier Diodes, (Stud Version), 35 A, 40 A, 60 A



DO-5 (DO-203AB)

FEATURES

- Low leakage current series
- Good surge current capability up to 1000 A
- Material categorization: for definitions of compliance please see www.vishay.com/doc?99912



RoHS
COMPLIANT

PRIMARY CHARACTERISTICS	
$I_{F(AV)}$	35 A, 40 A, 60 A
Package	DO-5 (DO-203AB)
Circuit configuration	Single

MAJOR RATINGS AND CHARACTERISTICS						
PARAMETER	TEST CONDITIONS	1N1183	1N3765	1N1183A	1N2128A	UNITS
$I_{F(AV)}$		35 ⁽¹⁾	35 ⁽¹⁾	40 ⁽¹⁾	60 ⁽¹⁾	A
	T_C	140 ⁽¹⁾	140 ⁽¹⁾	150 ⁽¹⁾	140 ⁽¹⁾	°C
I_{FSM}	50 Hz	480	380	765	860	A
	60 Hz	500 ⁽¹⁾	400 ⁽¹⁾	800 ⁽¹⁾	900 ⁽¹⁾	
I^2t	50 Hz	1140	730	2900	3700	A ² s
	60 Hz	1040	670	2650	3400	
$I^2\sqrt{t}$		16 100	10 300	41 000	52 500	A ² √s
V_{RRM}	Range	50 to 600 ⁽¹⁾	700 to 1000 ⁽¹⁾	50 to 600 ⁽¹⁾	50 to 600 ⁽¹⁾	V
T_J		-65 to +200	-65 to +200	-65 to +200	-65 to +200	°C

Note

⁽¹⁾ JEDEC® registered values

ELECTRICAL SPECIFICATIONS

VOLTAGE RATINGS				
TYPE NUMBER			V_{RRM} , MAXIMUM REPETITIVE PEAK REVERSE VOLTAGE ($T_J = -65\text{ °C to }+200\text{ °C}^{(2)}$) V	V_{RM} , MAXIMUM DIRECT REVERSE VOLTAGE ($T_J = -65\text{ °C to }+200\text{ °C}^{(2)}$) V
VS-1N1183	VS-1N1183A	VS-1N2128A	50 ⁽¹⁾	50 ⁽¹⁾
VS-1N1184	VS-1N1184A	VS-1N2129A	100 ⁽¹⁾	100 ⁽¹⁾
VS-1N1185	VS-1N1185A	VS-1N2130A	150 ⁽¹⁾	150 ⁽¹⁾
VS-1N1186	VS-1N1186A	VS-1N2131A	200 ⁽¹⁾	200 ⁽¹⁾
VS-1N1187	VS-1N1187A	VS-1N2133A	300 ⁽¹⁾	300 ⁽¹⁾
VS-1N1188	VS-1N1188A	VS-1N2135A	400 ⁽¹⁾	400 ⁽¹⁾
VS-1N1189	VS-1N1189A	VS-1N2137A	500 ⁽¹⁾	500 ⁽¹⁾
VS-1N1190	VS-1N1190A	VS-1N2138A	600 ⁽¹⁾	600 ⁽¹⁾
VS-1N3765	VS-1N2160		700 ⁽¹⁾	700 ⁽¹⁾
VS-1N3766			800 ⁽¹⁾	800 ⁽¹⁾
VS-1N3767			900 ⁽¹⁾	900 ⁽¹⁾
VS-1N3768			1000 ⁽¹⁾	1000 ⁽¹⁾

Notes

- Basic type number indicates cathode to case. For anode to case, add "R" to part number, e.g., 1N1188R, 1N3766R, 1N1186RA, 1N2135RA
- ⁽¹⁾ JEDEC® registered values
- ⁽²⁾ For 1N1183 Series and 1N3765 Series $T_C = -65\text{ °C to }+190\text{ °C}$



FORWARD CONDUCTION									
PARAMETER	SYMBOL	TEST CONDITIONS		1N1183	1N3765	1N1183A	1N2128A	UNITS	
Maximum average forward current at case temperature	I _{F(AV)}	1-phase operation, 180° sinusoidal conduction		35 ⁽¹⁾	35 ⁽¹⁾	40 ⁽¹⁾	60 ⁽¹⁾	A	
				140 ⁽¹⁾	140 ⁽¹⁾	150 ⁽¹⁾	140 ⁽¹⁾	°C	
Maximum peak one cycle non-repetitive surge current	I _{FSM}	Half cycle 50 Hz sine wave or 6 ms rectangular pulse	Following any rated load condition and with rated V _{RRM} applied	480	380	765	860	A	
				Half cycle 60 Hz sine wave or 5 ms rectangular pulse	500 ⁽¹⁾	400 ⁽¹⁾	800 ⁽¹⁾		900 ⁽¹⁾
		Half cycle 50 Hz sine wave or 6 ms rectangular pulse		Following any rated load condition and with ½ V _{RRM} applied following surge = 0	570	455	910		1000
					595	475	950		1050
Maximum I ² t for fusing	I ² t	t = 10 ms	With rated V _{RRM} applied following surge, initial T _J = T _J maximum	1140	730	2900	3700	A ² s	
		t = 8.3 ms		1040	670	2650	3400		
Maximum I ² t for individual device fusing		t = 10 ms	With V _{RRM} = 0 following surge, initial T _J = T _J maximum	1610	1030	4150	5250		
		t = 8.3 ms		1470	940	3750	4750		
Maximum I ² √t for individual device fusing	I ² √t ⁽²⁾	t = 0.1 to 10 ms, V _{RRM} = 0 following surge		16 100	10 300	41 500	52 500	A ² √s	
Maximum peak forward voltage at maximum forward current (I _{FM})	V _{FM}	T _J = 25 °C		1.7 ⁽¹⁾	1.8 ⁽¹⁾	1.3 ⁽¹⁾	1.3 ⁽¹⁾	V	
				110	110	126	188	A	
Maximum average reverse current	I _{R(AV)}	Maximum rated I _{F(AV)} and T _C		-	5.0 ⁽¹⁾	-	-	mA	
				-	4.0 ⁽¹⁾	-	-		
				-	3.0 ⁽¹⁾	-	-		
				-	2.0 ⁽¹⁾	-	-		
				Maximum rated I _{F(AV)} , V _{RRM} and T _C		10 ⁽¹⁾	-		2.5 ⁽¹⁾

Notes

- (1) JEDEC® registered values
- (2) I²t for time t_x = I²√t x √t_x

THERMAL AND MECHANICAL SPECIFICATIONS								
PARAMETER	SYMBOL	TEST CONDITIONS		1N1183	1N3765	1N1183A	1N2128A	UNITS
Maximum operating case temperature range	T _C			-65 to +190 ⁽¹⁾		-65 to +200		°C
Maximum storage temperature range	T _{Stg}			-65 to +175 ⁽¹⁾		-65 to +200		
Maximum internal thermal resistance, junction to case	R _{thJC}	DC operation		1.00 ⁽¹⁾		1.1 ⁽¹⁾	0.65 ⁽¹⁾	°C/W
Thermal resistance, case to sink	R _{thCS}	Mounting surface, smooth, flat and greased		0.25				
Maximum allowable mounting torque (+ 0 %, - 10 %)		Not lubricated thread, tightening on nut ⁽²⁾		3.4 (30)				N · m (lbf · in)
		Lubricated thread, tightening on nut ⁽²⁾		2.3 (20)				
		Not lubricated thread, tightening on hexagon ⁽³⁾		4.2 (37)				
		Lubricated thread, tightening on hexagon ⁽³⁾		3.2 (28)				
Approximate weight				17				g
				0.6				oz.
Case style		JEDEC®		DO-5 (DO-203AB)				

Notes

- (1) JEDEC registered values®
- (2) Recommended for pass-through holes
- (3) Recommended for holed threaded heatsinks

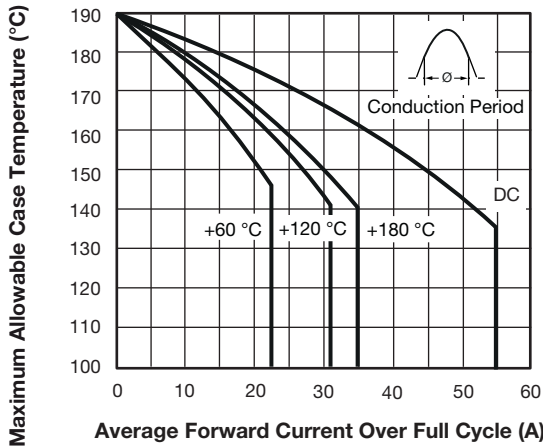

Fig. 1 - Maximum Allowable Case Temperature vs. Average Forward Current, 1N1183 and 1N3765 Series

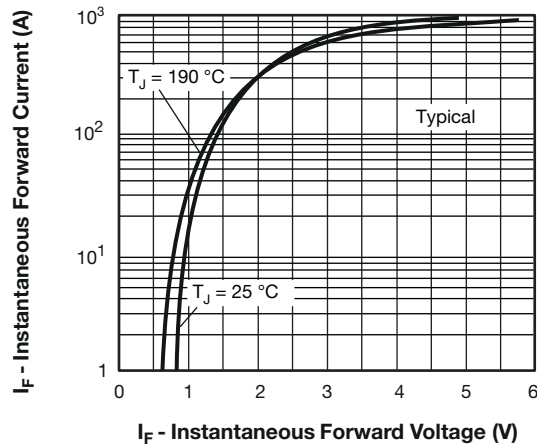

Fig. 4 - Typical Forward Voltage vs. Forward Current, 1N1183 and 1N3765 Series

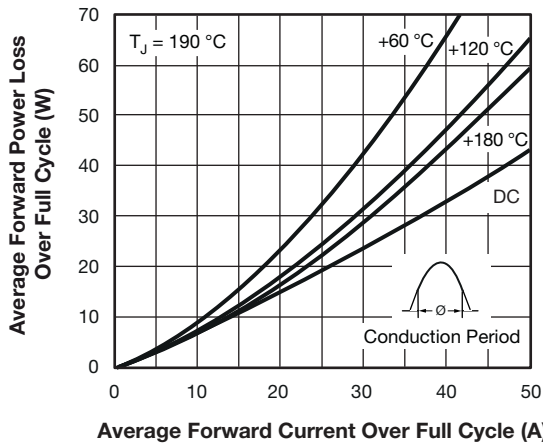

Fig. 2 - Typical Low Level Forward Power Loss vs. Average Forward Current (Sinusoidal Current Waveform), 1N1183 and 1N3765 Series

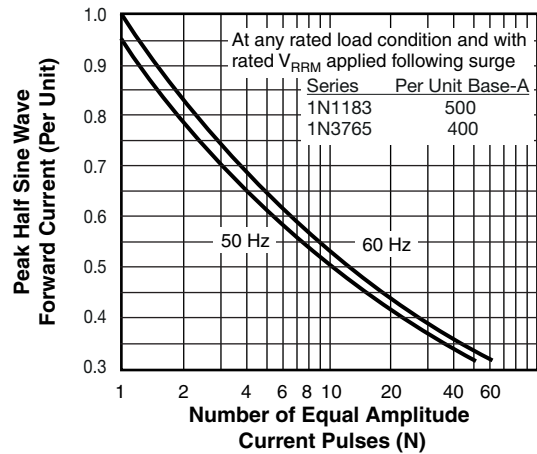

Fig. 5 - Maximum Non-Repetitive Surge Current vs. Number of Current Pulses, 1N1183 and 1N3765 Series

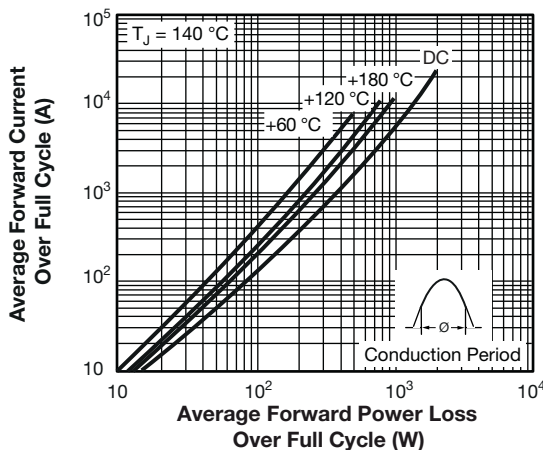

Fig. 3 - Typical High Level Forward Power Loss vs. Average Forward Current (Sinusoidal Current Waveform), 1N1183 and 1N3765 Series

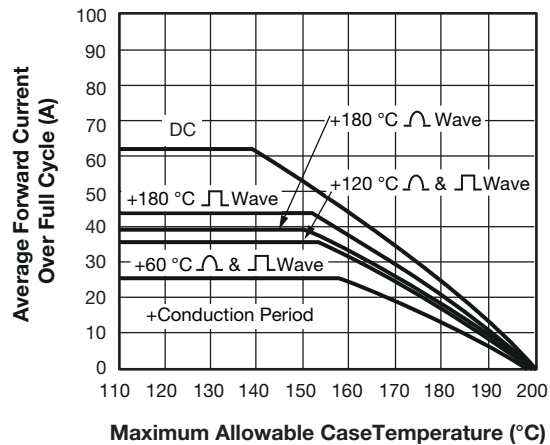

Fig. 6 - Average Forward Current vs. Maximum Allowable Case Temperature, 1N1183A Series

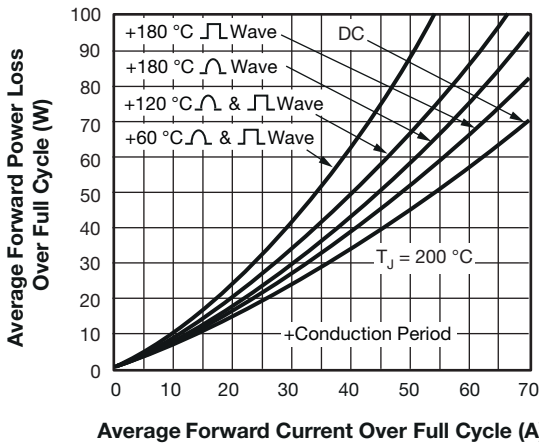

Fig. 7 - Maximum Low Level Forward Power Loss vs. Average Forward Current, 1N1183A Series

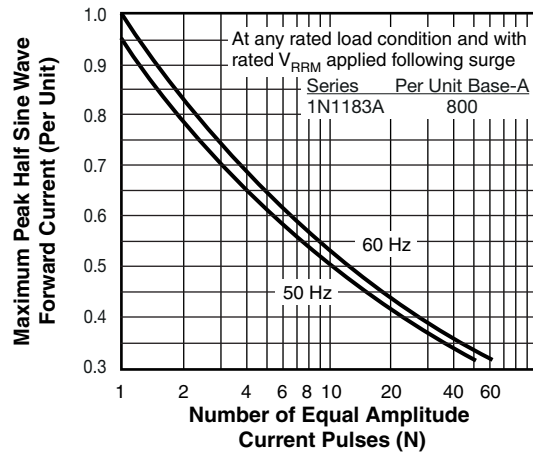

Fig. 10 - Maximum Non-Repetitive Surge Current vs. Number of Current Pulses, 1N1183A Series

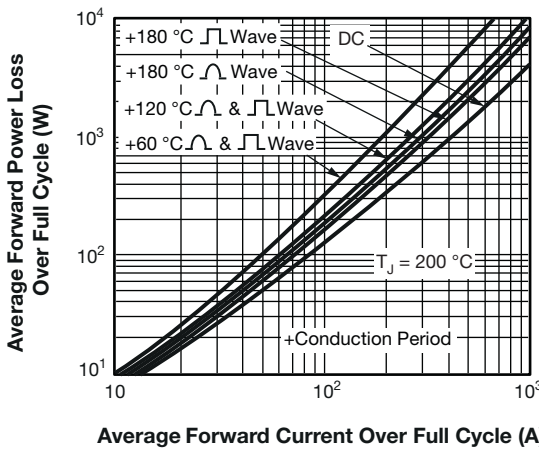

Fig. 8 - Maximum High Level Forward Power Loss vs. Average Forward Current, 1N1183A Series

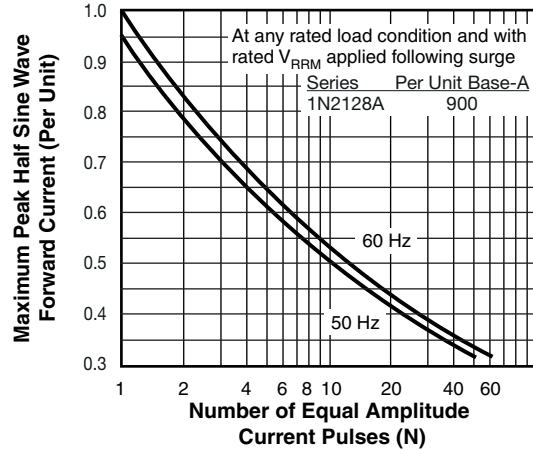

Fig. 11 - Maximum Non-Repetitive Surge Current vs. Number of Current Pulses, 1N2128A Series

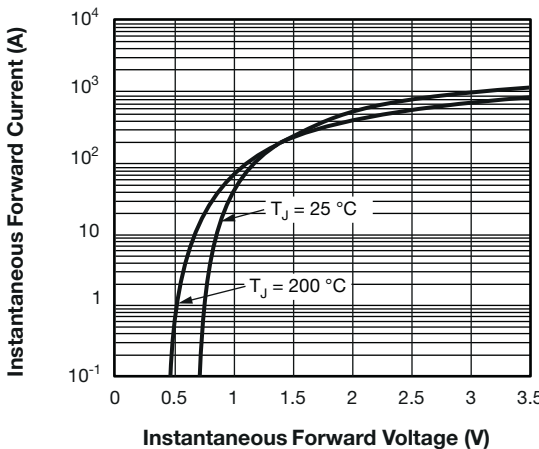

Fig. 9 - Maximum Forward Voltage vs. Forward Current, 1N1183A Series

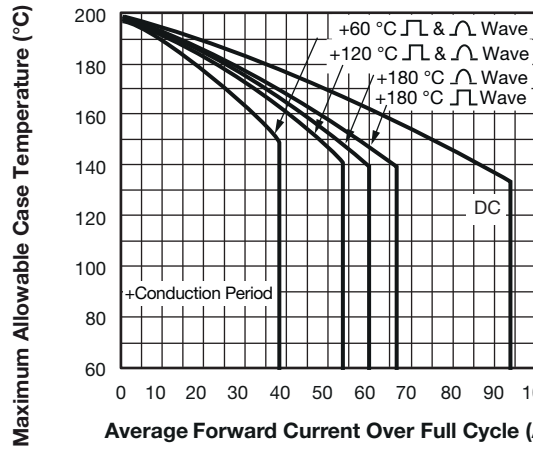

Fig. 12 - Maximum Allowable Case Temperature vs. Average Forward Current, 1N2128A Series

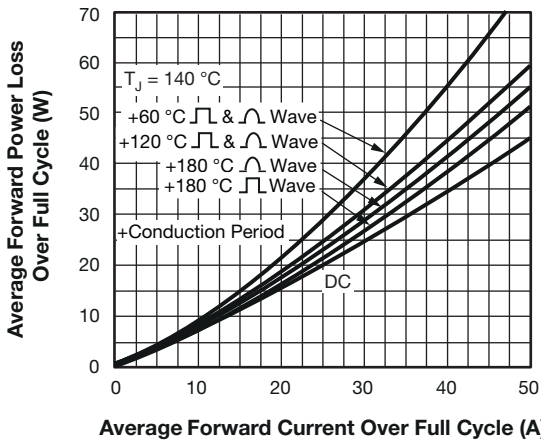

Fig. 13 - Maximum Low Level Forward Power Loss vs. Average Forward Current, 1N2128A Series

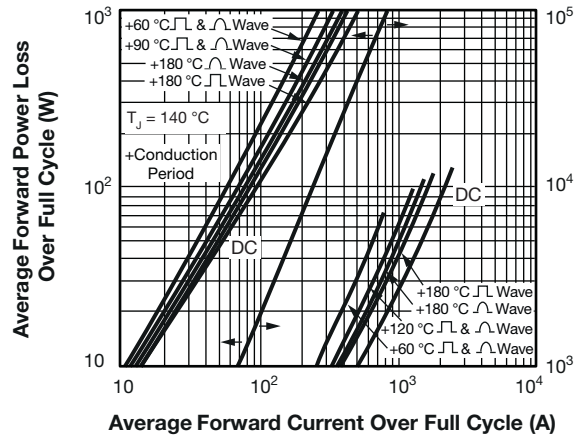

Fig. 14 - Maximum High Level Forward Power Loss vs. Average Forward Current, 1N2128A Series

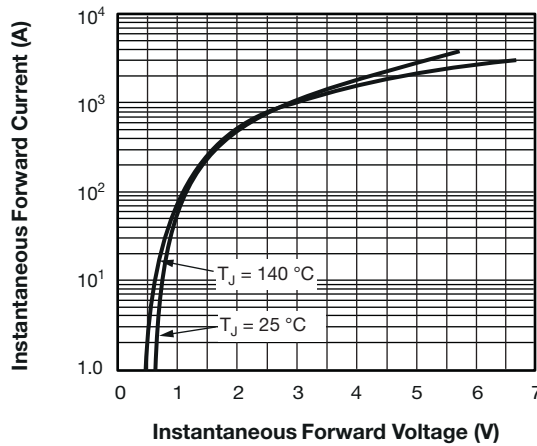

Fig. 15 - Maximum Forward Voltage vs. Forward Current, 1N2128A Series

LINKS TO RELATED DOCUMENTS

Dimensions	www.vishay.com/doc?95360
------------	--

DO-203AB (DO-5) for 1N1183, 1N3765, 1N1183A, 1N2128A, 1N3208 Series

DIMENSIONS in millimeters (inches)

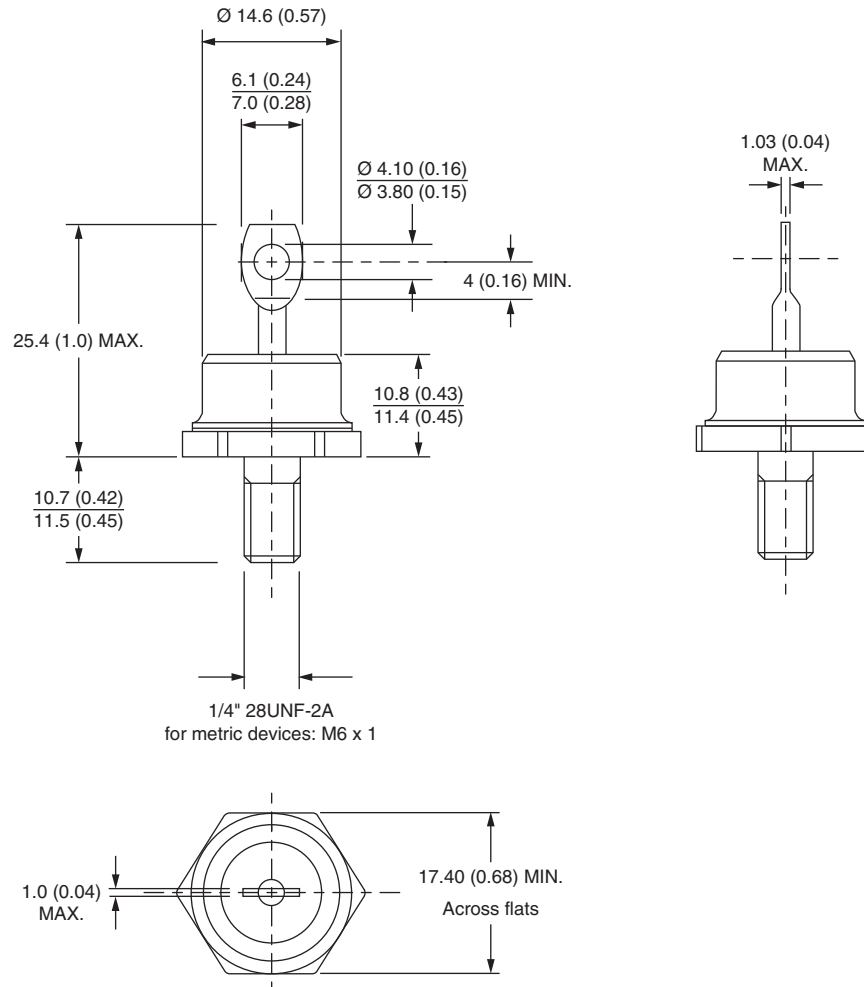



Disclaimer

ALL PRODUCT, PRODUCT SPECIFICATIONS AND DATA ARE SUBJECT TO CHANGE WITHOUT NOTICE TO IMPROVE RELIABILITY, FUNCTION OR DESIGN OR OTHERWISE.

Vishay Intertechnology, Inc., its affiliates, agents, and employees, and all persons acting on its or their behalf (collectively, "Vishay"), disclaim any and all liability for any errors, inaccuracies or incompleteness contained in any datasheet or in any other disclosure relating to any product.

Vishay makes no warranty, representation or guarantee regarding the suitability of the products for any particular purpose or the continuing production of any product. To the maximum extent permitted by applicable law, Vishay disclaims (i) any and all liability arising out of the application or use of any product, (ii) any and all liability, including without limitation special, consequential or incidental damages, and (iii) any and all implied warranties, including warranties of fitness for particular purpose, non-infringement and merchantability.

Statements regarding the suitability of products for certain types of applications are based on Vishay's knowledge of typical requirements that are often placed on Vishay products in generic applications. Such statements are not binding statements about the suitability of products for a particular application. It is the customer's responsibility to validate that a particular product with the properties described in the product specification is suitable for use in a particular application. Parameters provided in datasheets and / or specifications may vary in different applications and performance may vary over time. All operating parameters, including typical parameters, must be validated for each customer application by the customer's technical experts. Product specifications do not expand or otherwise modify Vishay's terms and conditions of purchase, including but not limited to the warranty expressed therein.

Except as expressly indicated in writing, Vishay products are not designed for use in medical, life-saving, or life-sustaining applications or for any other application in which the failure of the Vishay product could result in personal injury or death. Customers using or selling Vishay products not expressly indicated for use in such applications do so at their own risk. Please contact authorized Vishay personnel to obtain written terms and conditions regarding products designed for such applications.

No license, express or implied, by estoppel or otherwise, to any intellectual property rights is granted by this document or by any conduct of Vishay. Product names and markings noted herein may be trademarks of their respective owners.

Mouser Electronics

Authorized Distributor

Click to View Pricing, Inventory, Delivery & Lifecycle Information:

[Vishay:](#)

[VS-1N1184A](#) [VS-1N1188A](#) [VS-1N1190RA](#) [VS-1N2133RA](#) [VS-1N2137A](#) [VS-1N3765](#) [VS-1N2138A](#) [VS-1N3768R](#)
[VS-1N2131RA](#) [VS-1N2128A](#) [VS-1N2129A](#) [VS-1N2135RA](#) [VS-1N3767](#) [VS-1N1184](#) [VS-1N1185](#) [VS-1N1186A](#) [VS-](#)
[1N1188](#) [VS-1N1188R](#) [VS-1N1189R](#) [VS-1N1189A](#) [VS-1N1190A](#) [VS-1N1183A](#) [VS-1N1188RA](#) [VS-1N1183](#) [VS-](#)
[1N1184R](#) [VS-1N1184RA](#) [VS-1N1186RA](#) [VS-1N2129RA](#) [VS-1N2130RA](#) [VS-1N2131A](#) [VS-1N3766](#) [VS-1N3766R](#)
[VS-1N3768](#) [VS-1N1187R](#) [VS-1N2128RA](#) [VS-1N1190R](#) [VS-1N1189](#) [VS-1N1190](#) [VS-1N1189RA](#) [VS-1N1183R](#) [VS-](#)
[1N1186](#) [VS-1N1186R](#) [VS-1N1187](#) [VS-1N2138RA](#) [VS-1N1187A](#) [VS-1N2135A](#) [VS-1N1183RA](#) [VS-1N1185R](#) [VS-](#)
[1N2130A](#) [VS-1N1185A](#) [VS-1N2133A](#) [VS-1N1187RA](#)