



Designed specifically for world market applications, the B-series utilizes the hydraulic magnetic principle which provides precise operation and performance even when exposed to extremely hot and/or cold application environments.

Typical applications include power supplies, medical equipment, office equipment, control panels and marine equipment. In addition, these breakers meet CSA Standard 22.2 No. 100 for the Generator & Welder markets.

1-6 poles, 0.02 - 50 amps, up to 277 VAC or 80 VDC, with choice of time delays, terminals and actuator colors.

Agency Certifications

UL Recognized

UL Standard 1077



Component Recognition Program as Protectors Supplementary (Guide CCN/QVNU2, File E75596)

UL Standard 508



Switches, Industrial Control (Guide CCN/NRNT2, File E148683)

UL Standard 1500



Protectors, Supplementary for Marine Electrical & Fuel Systems (Guide PEQZ2, File E75596) Ignition Protection

UL Listed

UL Standard 489



Circuit Breakers, Molded Case, (Guide DIVQ, File E189195)

UL Standard 489A



Communications Equipment (Guide CCN/DITT, File E189195)

CSA Accepted



Component Supplementary Protector under Class 3215 30, File 047848 0 000 CSA Standard C22.2 No. 235

TUV Certified



EN60934, under License No. R72040875

VDE Certified



EN60934, VDE 0642 under File No. 10537

Electrical

Table A: Lists UL Recognized & CSA Certified configurations and performance capabilities as a Component Supplementary Protector.

B -SERIES TABLE A: COMPONENT SUPPLEMENTARY PROTECTORS										
CIRCUIT CONFIGURATION	VOLTAGE			CURRENT RATING		SHORT CIRCUIT CAPACITY (AMPS)		APPLICATION CODES		CONSTRUCTION NOTES
	MAX. RATING	FREQUENCY	PHASE	FULL LOAD AMPS	GENERAL PURPOSE AMPS	UL/CSA		UL	CSA	
						WITH BACKUP FUSE	WITHOUT BACKUP FUSE			
SERIES	65	DC	---	31 - 50	---	---	7500	TC1,2, OL1,U1	TC1,2, OL1,U1	
	80	DC	---	0.02 - 30	---	---	7500	TC1,2, OL1,U1	TC1,2, OL1,U1	
				---	31 - 50	---	7500	TC1,2, OL0,U1	TC1,2, OL0,U1	
	125	50 / 60	1	1 - 50	---	---	2000	TC1, OL1,U2	TC1, OL1,U2	
	125	50 / 60	1 ⁴	1 - 50	---	---	1000	TC1, OL1,U2	TC3, OL1,U3	
	125 / 250	50 / 60	1 ³	0.02 - 30	---	---	3000	TC1,2, OL1,U1	TC1,2, OL1,U1	
	250	50 / 60	1	0.02 - 30	---	---	1500	TC1, OL0,U2	TC1, OL0,U2	Single Pole Break
				0.02 - 30	---	---	3000	TC1, OL1,U2	TC1, OL1,U2	Two Pole Break
				---	31 - 50	---	3000	TC1,2, OL0,U1	TC1,2, OL0,U1	
			1 ⁴	1 - 50	---	1000	TC1, OL1,U2	TC3, OL1,U3		
3			0.02 - 30	---	5000 ²	---	TC1,2, OL1,C1	TC1,2, OL1,C1		
277	50 / 60	1	0.02 - 30	---	5000 ¹	---	TC1,2, OL1,C1	TC1,2, OL1,C1		
DUAL COIL	65	DC	---	0.02 - 50	---	---	7500	TC1,2, OL1,U1	TC1,2, OL1,U1	
	80	DC	---	0.02 - 30	---	---	7500	TC1,2, OL1,U1	TC1,2, OL1,U1	
				---	31 - 50	---	7500	TC1,2, OL0,U1	TC1,2, OL0,U1	
	125	50 / 60	1	1 - 50	---	---	2000	TC1, OL1,U2	TC1, OL1,U2	
	125 / 250	50 / 60	1 ³	0.02 - 30	---	---	3000	TC1,2, OL1,U1	TC1,2, OL1,U1	
	250	50 / 60	1	0.02 - 30	---	---	1500	TC1, OL0,U2	TC1, OL0,U2	Single Pole Break
				0.02 - 30	---	---	3000	TC1, OL1,U2	TC1, OL1,U2	Two Pole Break
				---	31 - 50	---	3000	TC1,2, OL0,U1	TC1,2, OL0,U1	
			1 ⁴	1 - 50	---	1000	TC1, OL1,U2	TC3, OL1,U3		
			3	0.02 - 30	---	5000 ²	---	TC1,2, OL1,C1	TC1,2, OL1,C1	
277	50 / 60	1	0.02 - 30	---	5000 ¹	---	TC1,2, OL1,U1	TC1,2, OL1,U1		
SHUNT	80	DC	---	0.02 - 30	---	---	7500	TC1,2, OL1,U1	TC1,2, OL1,U1	
	125 / 250	50 / 60	1 ³	0.02 - 30	---	---	3000	TC1,2, OL1,U1	TC1,2, OL1,U1	
	250	50 / 60	1	0.02 - 30	---	---	3000	TC1,2, OL1,U1	TC1,2, OL1,U1	
				0.02 - 30	---	5000 ²	---	TC1,2, OL1,C1	TC1,2, OL1,C1	
	277	50 / 60	1	0.02 - 30	---	5000 ¹	---	TC1,2, OL1,C1	TC1,2, OL1,C1	
RELAY	80	DC	---	0.02 - 30	---	---	7500	TC1,2, OL1,U1	TC1,2, OL1,U1	
	125 / 250	50 / 60	1 ³	0.02 - 30	---	---	3000	TC1,2, OL1,U1	TC1,2, OL1,U1	
	250	50 / 60	1	0.02 - 30	---	---	3000	TC1,2, OL1,U1	TC1,2, OL1,U1	
				0.02 - 30	---	5000 ²	---	TC1,2, OL1,C1	TC1,2, OL1,C1	
	277	50 / 60	1	0.02 - 30	---	5000 ¹	---	TC1,2, OL1,C1	TC1,2, OL1,C1	
SWITCH ONLY	65	DC	---	0.02 - 50	---	---	---	---	---	
	80	DC	---	0.02 - 30	---	---	---	---	---	
	250	50 / 60	1	---	31 - 50	---	---	---	---	
			3	0.02 - 50	---	---	---	---	---	
277	50 / 60	1	0.02 - 30	31 - 50	---	---	---	---		

Notes for Table A:

- 1 Requires branch circuit backup with a UL LISTED Type K5 or RK5 fuse (15A minimum) at no more than 4 times the rating of the protector.
- 2 Same as note 1, except that backup fuse is limited to 80A maximum.
- 3 2 pole protector required (with one pole per power line) for: 250/125 VAC, 125/250 VAC and 208Y/120 VAC Power Systems. 1 pole protector required for: 125 VAC, 1Ø Power System.

Electrical

Table B: Lists UL Recognized, CSA, VDE & TUV Certified configurations & performance capabilities as a Component Supplementary Protector.

B-SERIES TABLE B: COMPONENT SUPPLEMENTARY PROTECTORS															
CIRCUIT CONFIGURATION	VOLTAGE			CURRENT RATING		SHORT CIRCUIT CAPACITY (AMPS)						APPLICATION CODES		CONSTRUCTION NOTES	
	MAX. RATING	FREQUENCY	PHASE	FULL LOAD AMPS	GENERAL PURPOSE AMPS ¹	UL/CSA		VDE		TUV		UL	CSA		
						WITH BACKUP FUSE	WITHOUT BACKUP FUSE	(Inc) WITH BACKUP FUSE	(Inc) WITHOUT BACKUP	(Inc) WITH BACKUP FUSE	(Inc) WITHOUT BACKUP				
SERIES	80	DC	---	0.10 - 30	---	---	7500	3000	1500	3000	1500	TC1,2, OL1,U1	TC1,2, OL1,U1		
				31 - 50	31 - 50	---	7500	3000	1500	3000	1500	TC1,2, OL0,U1	TC1,2, OL0,U1		
				0.10 - 30	---	---	7500	3000	1500	3000	1500	TC1,2, OL1,U1	TC1,2, OL1,U1		
				31 - 32	---	---	7500	3000	1500	3000	1500	TC1,2, OL1,U1	TC1,2, OL1,U1		
				31 - 50	31 - 50	---	7500	3000	1500	3000	1500	TC1,2, OL0,U1	TC1,2, OL0,U1		
				0.10 - 30	---	---	3000	3000	1500	5000	1500	TC1,2, OL1,U1	TC1,2, OL1,U1		
	250	50 / 60	1	0.10 - 30	---	---	3000	---	---	5000	1500	TC1,2, OL0,U1	TC1,2, OL0,U1		
				31 - 50	31 - 50	---	3000	---	---	5000	1500	TC1,2, OL0,U1	TC1,2, OL0,U1		
				31 - 32	---	---	3000	6000	1500	5000	1500	TC1,2, OL1,U1	TC1,2, OL1,U1		
				0.10 - 30	---	---	1500	3000	1500	5000	1500	TC1, OL0,U2	TC1, OL0,U2	Single Pole Break	
				0.10 - 30	---	---	3000	3000	1500	5000	1500	TC1, OL1,U2	TC1, OL1,U2	Two Pole Break	
				0.10 - 30	---	---	5000 ³	---	3000	1500	3000	1500	TC1,2, OL1,C1	TC1,2, OL1,C1	
415	50 / 60	3	0.10 - 30	---	---	1000	3000	1500	3000	1500	TC1,2, OL1,C1	TC1,2, OL1,C1			
DUAL COIL	80	DC	---	0.10 - 30	---	---	7500	3000	1500	3000	1500	TC1,2, OL1,U1	TC1,2, OL1,U1		
				0.10 - 30	---	---	3000	3000	1500	5000	1500	TC1,2, OL1,U1	TC1,2, OL1,U1		
				30 - 50	31 - 50	---	3000	---	---	5000	1500	TC1,2, OL0,U1	TC1,2, OL0,U1		
	250	50 / 60	1	0.10 - 30	---	---	5000 ³	---	3000	1500	3000	1500	TC1,2, OL1,C1	TC1,2, OL1,C1	
				31 - 50	---	---	2000 ²	---	---	3000	1500	TC1,2, OL1,C1	TC1,2, OL1,C1		
				0.10 - 30	---	---	3000	---	---	5000	1500	TC1,2, OL0,U1	TC1,2, OL0,U1		
SHUNT	80	DC	---	0.10 - 30	---	---	7500	3000	1500	3000	1500	TC1,2, OL1,U1	TC1,2, OL1,U1		
				0.10 - 30	---	---	7500	3000	1500	3000	1500	TC1,2, OL1,U1	TC1,2, OL1,U1		
				0.10 - 30	---	---	3000	3000	1500	5000	1500	TC1,2, OL1,U1	TC1,2, OL1,U1		
	250	50 / 60	1	0.10 - 30	---	---	3000	---	---	5000	1500	TC1,2, OL0,U1	TC1,2, OL0,U1		
				30 - 50	31 - 50	---	3000	---	---	5000	1500	TC1,2, OL0,U1	TC1,2, OL0,U1		
				0.10 - 30	---	---	5000 ³	---	3000	1500	3000	1500	TC1,2, OL1,C1	TC1,2, OL1,C1	
31 - 50	---	---	2000 ²	---	---	---	3000	1500	TC1,2, OL1,C1	TC1,2, OL1,C1					

Notes for Table B:

- 1 General Purpose Ratings for UL/CSA Only.
- 2 Requires branch circuit backup with a UL LISTED Type K5 or RK5 fuse (15A minimum) at no more than 4 times the rating of the protector.
- 3 Same as note 1, except that backup fuse is limited to 80 A maximum.

Table C: Lists UL Recognized, CSA Certified configurations and performance capabilities as Protectors, Supplementary for Marine Electrical and Fuel Systems (CCN/Guide PEQZ2, File E75596). Ignition Protected per UL 1500. UL Classified Small Craft Electrical Devices, Marine in accordance with ISO 8846 (CCN/Guide UZMK, File MQ1515) as Marine Supplementary Protectors.

B-SERIES TABLE C: UL1500 (Marine Ignition Protected)							
CIRCUIT CONFIGURATION	VOLTAGE			CURRENT RATING	SHORT CIRCUIT CAPACITY (AMPS)	APPLICATION CODES	
	MAX. RATING	FREQUENCY	PHASE	FULL LOAD AMPS	WITHOUT BACKUP FUSE	UL	CSA
SERIES	14 ¹	DC	---	0.02 - 50	5000	TC1,2,OL1,U1	TC1,2,OL1,U1
	32 ¹	DC	---	0.02 - 50	5000	TC1,2,OL1,U2	TC1,2,OL1,U2
	65	DC	---	0.02 - 50	3000	TC1,2,OL1,U1	TC1,2,OL1,U1
	125 / 250	50 / 60	1 ²	0.02 - 50	1500	TC1,2,OL1,U1	TC1,2,OL1,U1
	250	50 / 60	1	0.02 - 30	1000	TC1,2,OL1,U1	TC1,2,OL1,U1

Notes for Table C:

- 1 Available with special catalog number only (consult factory).
- 2 2 pole protector required (with one pole per power line) for: 250/125 VAC, 125/250 VAC and 208Y/120 VAC Power Systems. 1 pole protector required for: 125 VAC, 1Ø Power System.

Table D: Lists UL Listed configurations and performance capabilities as Circuit Breakers for use in Communications Equipment (CCN/Guide DITT, File E189195), under UL489A

B-SERIES TABLE D: UL489A (COMMUNICATIONS EQUIPMENT)				
CIRCUIT CONFIGURATION	VOLTAGE		CURRENT RATING	INTERRUPTING CAPACITY (AMPS)
	MAX. RATING	FREQUENCY	GENERAL PURPOSE AMPS	WITHOUT BACKUP FUSE
SERIES	80	DC	0.10 - 50	5000
	80	DC	60 - 90 ¹	5000

Notes for Table D:

- 1 60 - 90 amp ratings require parallel pole construction

Electrical

Maximum Voltage	277VAC 50/60 Hz, 80VDC
Current Ratings	Standard current coils: 0.100, 0.250, 0.500, 0.750, 1.00, 2.50, 5.00, 7.50, 10.0, 15.0, 20.0, 25.0, 30.0, 35.0, 40.0 and 50.0 amps. Other ratings available, see ordering scheme.
Standard Voltage Coils	DC - 6V, 12V; AC - 120V, other ratings available, see ordering scheme.
Auxiliary Switch Rating	SPDT; 10.1 AMPS - 250VAC, 1.0A 65 VDC or 0.5A 80 VDC, 0.1 Amps - 125VAC (with gold contacts). VDE-1.0 Amp - 125VAC.
Insulation Resistance	Minimum of 100 Megohms at 500 VDC.
Dielectric Strength	UL, CSA - 1500 V 50/60 Hz for one minute between all electrically isolated terminals. B-Series circuit breakers comply with the 8mm spacing and 3750V 50/60 Hz dielectric requirements from hazardous voltage to operator accessible surfaces, between adjacent poles and from main circuits to auxiliary circuits per Publications EN 60950 and VDE 0805.
Resistance, Impedance	Values from Line to Load Terminal - based on Series Trip Circuit Breaker.

RESISTANCE, IMPEDANCE VALUES
from Line to Load Terminals
(Values Based on Series Trip Circuit Breaker)

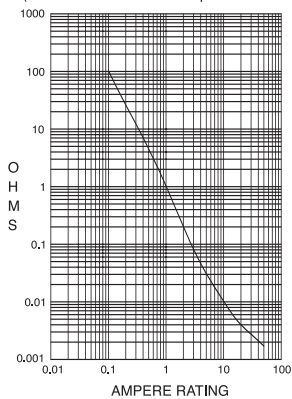

CURRENT (AMPS)	TOLERANCE (%)
0.10 - 5.0	15%
5.1 - 20.0	25%
20.1 - 50.0	35%

Pulse Tolerance Curves

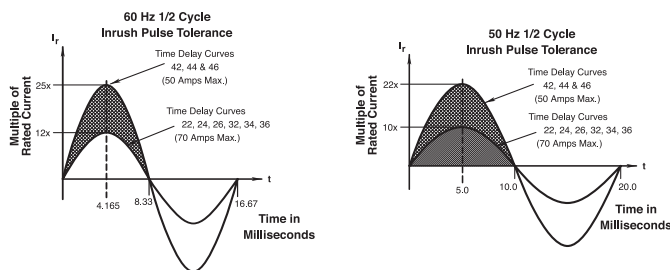

Mechanical

Endurance	10,000 ON-OFF operations @ 6 per minute; with rated Current and Voltage.
Trip Free	All B-Series Circuit Breakers will trip on overload, even when Handle is forcibly held in the ON position.
Trip Indication	The operating Handle moves positively to the OFF position when an overload causes the breaker to trip.

Physical

Number of Poles	1 - 6 poles at 30 Amps or less. 1 and 2 poles at 31 Amps thru 50 Amps.
Internal Circuit Config.	Series, (with or without auxiliary switch), Shunt and Relay with current or voltage trip coils, Dual Coil, Switch Only (with or without auxiliary switch).
Weight	Approximately 65 grams/pole. (Approximately 2.32 ounces/pole.)
Standard Colors	Housing- Black; Actuator - See Ordering Scheme.

Environmental

Designed and tested in accordance with requirements of specification MIL-PRF- 55629 and MIL-STD-202 as follows:

Shock	Withstands 100 Gs, 6ms, sawtooth while carrying rated current per Method 213, Test Condition "I". Instantaneous and ultra-short curves tested @ 90% of rated current.
Vibration	Withstands 0.060" excursion from 10-55 Hz, and 10 Gs 55-500 Hz, at rated current per Method 204C, Test Condition A. Instantaneous and ultrashort curves tested at 90% of rated current.
Moisture Resistance	Method 106D, i.e., ten 24-hour cycles @ + 25°C to +65°C, 80-98% RH.
Salt Spray	Method 101, Condition A (90-95% RH @ 5% NaCl Solution, 96 hrs).
Thermal Shock	Method 107D, Condition A (Five cycles @ -55°C to +25°C to +85°C to +25°C).
Operating Temperature	-40° C to +85° C

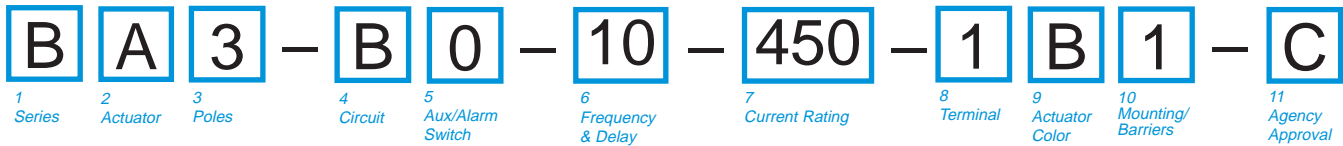

1 SERIES			
B			
2 ACTUATOR¹			
A	Handle, one per pole		
B	Handle, one per multipole unit		
S	Mid-Trip Handle, one per pole		
T	Mid-Trip Handle, one per pole & Alarm Switch		
3 POLES			
1	One		
2	Two		
3	Three		
4	Four		
5	Five		
6	Six		
4 CIRCUIT			
A ²	Switch Only (No Coil)	G ³	Relay Trip (Voltage)
B	Series Trip (Current)	H ^{3,4}	Dual Coil with Shunt Trip Voltage Coil
C	Series Trip (Voltage)	J ^{3,4}	Dual Coil with Shunt Trip Voltage Coil (side terminal)
D ³	Shunt Trip (Current)	K ^{3,4}	Dual Coil with Relay Trip Voltage Coil
E ³	Shunt Trip (Voltage)		
F ³	Relay Trip (Current)		
5 AUXILIARY/ALARM SWITCH⁵		5	S.P.S.T., 0.093 Q.C. w/o Aux Switch
0	w/o Aux Switch	6	S.P.S.T., 0.139 Solder Lug
1	S.P.D.T., 0.093 Q.C. Term.	7	S.P.S.T., 0.110 Q.C. Term.
2	S.P.D.T., 0.110 Q.C. Term.	8	S.P.S.T., 0.187 Q.C. Term. (Gold Contacts)
3	S.P.D.T., 0.139 Solder Lug	9	S.P.D.T., 0.187 Q.C. Term. (Gold Contacts)
4	S.P.D.T., 0.110 Q.C. Term. (Gold Contacts)		
6 FREQUENCY & DELAY		30	DC, 50/60Hz Instantaneous
03 ²	DC 50/60Hz, Switch Only	31	DC, 50/60Hz Ultra Short
10 ⁶	DC Instantaneous	32	DC, 50/60Hz Short
11	DC Ultra Short	34	DC, 50/60Hz Medium
12	DC Short	36	DC, 50/60Hz Long
14	DC Medium	42 ⁷	50/60Hz Short, Hi-Inrush
16	DC Long	44 ⁷	50/60Hz Medium, Hi-Inrush
20 ⁶	50/60Hz Instantaneous	46 ⁷	50/60Hz Long, Hi-Inrush
21	50/60Hz Ultra Short	52 ⁷	DC, Short, Hi-Inrush
22	50/60Hz Short	54 ⁷	DC, Medium, Hi-Inrush
24	50/60Hz Medium	56 ⁷	DC, Long, Hi-Inrush
26	50/60Hz Long		

Notes:

- Actuator Code:
A: Handle tie pin spacer(s) and retainers provided unassembled with multi-pole units.
B: Handle location as viewed from front of breaker:
2 pole - left pole
4 pole - two handles at center poles
6 pole - four handles at center poles
3 pole - center pole
5 pole - three handles at center poles
- Handle moves to mid-position only upon electrical trip of the breaker. Available with circuit codes B, C, D, E, F, G, H and K.
- Handle moves to mid-position and alarm switch activates only upon electrical trip of the breaker. Available with circuit codes B & C.
- Switch Only circuits, rated up to 50 amps and 6 poles, and only available with VDE Certification when tied to a protected pole (Circuit Code B, C, D or H.). For .02 to 30 amps, select Current Code 630. For 35 - 50 amps, select Current Code 650.
- Available with Terminal Codes 1, 2 and 3. Current Rating limited to 30 amps maximum.
- Consult factory for available Dual Coil options, as special catalog number is required. With Shunt construction, Dual Coils will trip instantaneously on line voltage. Dual coils require 30VA minimum power to trip and are rated for intermittent duty only.
- Auxiliary Switch breakers with Series Trip and Switch Only circuits. On multi-pole breakers, one aux. switch is supplied, mounted in the extreme right pole.
- Separate pole type voltage coils not rated for continuous duty. Available only with delay codes 10 and 20.
- Available with Circuit Codes B & D only. VDE Certified to 30 amps. UL Recognized and CSA Accepted to 50 amps.
- VDE Certification available with single pole breakers with DC Delay only. UL Recognition and CSA Accepted available in one and two pole breakers.
- Screw Terminals are recommended on ratings greater than 20 amps. Ratings over 30 amps are only available with Terminal Codes 5, 9, G, H, M and Q.
- VDE Certification up to 25 amps and UL Recognition and CSA Acceptance up to 30 amps, but not recommended over 20 amps.
- Terminal Codes 3, 5 E and H (Bus Type) with VDE, are supplied with Lock Washers, and Terminal Code M (M6 Threaded Stud) with VDE is supplied with Lock and Flat Washers. These breakers are only VDE Certified when the washers are used.
- VDE Cert. available up to 12 amps. UL Rec. & CSA Acceptance available up to 30 amps.
- Single pole breakers with Terminal Code P (Printed Circuit Board) are available up to 30 amps with VDE Certification and 50 amps with UL Recognition and CSA Acceptance, with Circuit Codes A, B and C. Two pole breakers with Terminal Code P (Printed Circuit Board) are available up to 40 amps with UL Recognition and CSA Acceptance with Circuit Codes A, B and C.
- Available with Actuator Codes A, S and T.
- Available with voltage coils only.
- Terminal Code Q not available with VDE approvals.

7 CURRENT RATING (AMPERES)									
020	0.020	230	0.300	425	2.500	612	12.000		
025	0.025	235	0.350	527	2.750	712	12.500		
030	0.030	240	0.400	430	3.000	613	13.000		
035	0.035	245	0.450	435	3.500	614	14.000		
040	0.040	250	0.500	440	4.000	615	15.000		
045	0.045	255	0.550	445	4.500	616	16.000		
050	0.050	260	0.600	450	5.000	617	17.000		
055	0.055	265	0.650	455	5.500	618	18.000		
060	0.060	270	0.700	460	6.000	620	20.000		
065	0.065	275	0.750	465	6.500	622	22.000		
070	0.070	280	0.800	470	7.000	624	24.000		
075	0.075	285	0.850	475	7.500	625	25.000		
080	0.080	290	0.900	480	8.000	630	30.000		
085	0.085	295	0.950	485	8.500	635 ^a	35.000		
090	0.090	410	1.000	490	9.000	640 ^a	40.000		
095	0.095	512	1.250	495	9.500	645 ^a	45.000		
210	0.100	415	1.500	610	10.000	650 ^a	50.000		
215	0.150	517	1.750	710	10.500				
220	0.200	420	2.000	611	11.000				
225	0.250	522	2.250	711	11.500				
OR VOLTAGE COIL (NOMINAL RATED VOLTAGE)⁶									
A06	6 DC	A32	32 DC	J12	12 AC	J65	65 AC		
A12	12 DC	A48	48 DC	J18	18 AC	K20	120 AC		
A18	18 DC	A65	65 DC	J24	24 AC	L40	240 AC		
A24	24 DC	J06	6 AC	J48	48 AC				

8 TERMINAL⁹		E ¹¹	Screw M4 (Bus Type)
1 ¹⁰	Push-On 0.250 Tab (Q.C.)	F	Screw M5 w/upturned lugs and 30° bend
2	Screw 8-32 w/upturned lugs	G	Screw M5 (Bus Type) and 30° bend
3 ¹¹	Screw 8-32 (Bus Type)	H	Screw M5 (Bus Type)
4	Screw 10-32 w/upturned lugs	L ¹²	0.250 Q.C./ Solder Lug
5 ¹¹	Screw 10-32 (Bus Type)	M ¹¹	M6 Threaded Studs
6	Screw 8-32 w/upturned lugs and 30° bend	P ¹³	Printed Circuit Board Terminals
7	Screw 8-32 (Bus Type) and 30° bend	Q ¹⁶	Push-In Stud
8	Screw 10-32 w/upturned lugs and 30° bend	R	Screw M4 w/upturned lugs and 30° bend
9	Screw 10-32 (Bus Type) and 30° bend	S ¹⁵	Push-On 0.110 Tab (Q.C.)
B	Screw M5 w/upturned lugs	T	Screw M4 (Bus Type) and 30° bend
C	Screw M4 w/upturned lugs		

9 ACTUATOR COLOR & LEGEND				
I-O	ON-OFF	Dual	Legend Color	
White	A	B	1	Black
Black	C	D	2	White
Red	F	G	3	White
Green	H	J	4	White
Blue	K	L	5	White
Yellow	M	N	6	Black
Gray	P	Q	7	Black
Orange	R	S	8	Black

10 MOUNTING/BARRIERS		
MOUNTING STYLE		
	Threaded Insert, 2 per pole	
1	6-32 x 0.195 inches	no
A	6-32 X 0.195 inches (multi-pole units only)	yes
2	ISO M3 x 5mm	no
B	ISO M3 x 5mm	yes
Rectangular Adapter Plate with mounting centers of 2.062" [52.37mm] and Threaded insert, 2 per pole		
3 ¹⁴	6-32 x 0.225 inches	no
C ¹⁴	6-32 X 0.225 inches (multi-pole units only)	yes
4 ¹⁴	ISO M3 x 6.5mm	no
D ¹⁴	ISO M3 x 6.5mm	yes
Front panel Snap-In, 0.75" [19.05mm] wide bezel		
5	without Handleguard	no
6	without Handleguard (multi-pole units only)	yes
Front panel Snap-In, 0.96" [24.48mm] wide bezel		
7	without Handleguard, 1-pole units 0.96" wide;	no
multipole units have .105" bezel overhang on all sides		
8	without Handleguard, 1-pole units 0.96" wide;	yes
(multi-pole units only) .105" bezel overhang on all sides		

11 AGENCY APPROVAL	
C	UL Recognized & CSA Accepted
D	VDE Certified, UL Recognized & CSA Accepted
E	TUV Certified, UL Recognized & CSA Accepted
I	UL Rec. STD 1077, UL Rec. 1500 (ignition protected), & CSA Accepted

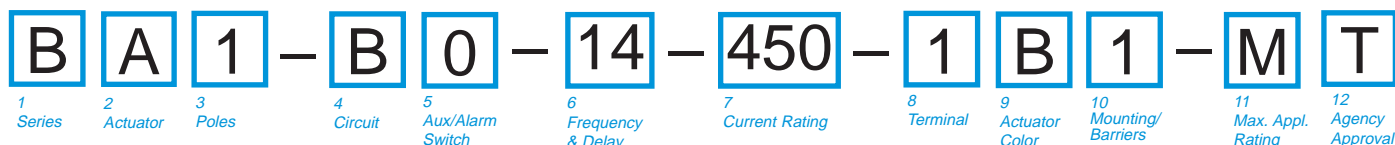

1 SERIES
B

2 ACTUATOR¹
A Handle, one per pole
B Handle, one per multipole unit
S Mid-Trip Handle, one per pole
T Mid-Trip Handle, one per pole & Alarm Switch

3 POLES
1 One **2** Two **3** Three **4** Four

4 CIRCUIT
B Series Trip (Current)

5 AUXILIARY/ALARM SWITCH²
0 w/o Aux Switch **7** S.P.S.T., 0.110 Q.C.
1 S.P.D.T., 0.093 Q.C. Term. Term.(Gold Contacts)
2 S.P.D.T., 0.110 Q.C. Term. **8** S.P.S.T., 0.187 Q.C. Term.
3 S.P.D.T., 0.139 Solder Lug **9** S.P.D.T., 0.187 Q.C. Term.

6 FREQUENCY & DELAY³
11 DC Ultra Short **52** DC, Short,Hi-Inrush
12 DC Short **54** DC, Medium, Hi-Inrush
14 DC Medium **56** DC, Long, Hi-Inrush
16 DC Long

7 CURRENT RATING (AMPERES)

210	0.100	415	1.500	710	10.500
215	0.150	517	1.750	611	11.000
220	0.200	420	2.000	711	11.500
225	0.250	522	2.250	612	12.000
230	0.300	527	2.750	712	12.500
235	0.350	430	3.000	613	13.000
240	0.400	435	3.500	614	14.000
245	0.450	440	4.000	615	15.000
250	0.500	445	4.500	616	16.000
255	0.550	450	5.000	617	17.000
260	0.600	455	5.500	618	18.000
265	0.650	460	6.000	620	20.000
270	0.700	465	6.500	622	22.000
275	0.750	470	7.000	624	24.000
280	0.800	475	7.500	625	25.000
285	0.850	480	8.000	630	30.000
290	0.900	485	8.500	635⁵	35.000
295	0.950	490	9.000	640⁵	40.000
410	1.000	495	9.500	645⁵	45.000
512	1.250	610	10.000	650⁵	50.000

8 TERMINAL⁴

1⁵ Push-On 0.250 Tab (Q.C.)	9 Screw 10-32 (Bus Type) and 30° bend
2 Screw 8-32 w/upturned lugs	B Screw M5 w/upturned lugs
3⁶ Screw 8-32 (Bus Type)	F Screw M5 w/upturned lugs and 30° bend
4 Screw 10-32 w/upturned lugs	G Screw M5 (Bus Type) and 30° bend
5⁶ Screw 10-32 (Bus Type)	H Screw M5 (Bus Type)
6 Screw 8-32 w/upturned lugs and 30° bend	M⁶ M6 Threaded Stud
7 Screw 8-32 (Bus Type) and 30° bend	P⁷ Printed Circuit Board Terminals
8 Screw 10-32 w/upturned lugs and 30° bend	Q⁸ Push-In Stud

9 ACTUATOR COLOR

LEGEND

ON-OFF	Dual	Legend Color
White	B 1	Black
Black	D 2	White
Red	G 3	White
Green	J 4	White
Blue	L 5	White
Yellow	N 6	Black
Gray	Q 7	Black
Orange	S 8	Black

10 MOUNTING/BARRIERS

MOUNTING STYLE	BARRIERS
Threaded Insert, 2 per pole	
1 6-32 x 0.195 inches	no
A 6-32 X 0.195 inches (multi-pole units only)	yes
2 ISO M3 x 5mm	no
B ISO M3 x 5mm (multi-pole units only)	yes
Rectangular Adapter Plate with mounting centers of 2.062 inches and Threaded insert, 2 per pole	
3 6-32 x 0.225 inches	no
C 6-32 X 0.225 inches (multi-pole units only)	yes
4 ISO M3 x 6.5mm	no
D ISO M3 x 6.5mm (multi-pole units only)	yes
Front panel Snap-In, 0.75" wide bezel	
5 without Handleguard	no
6 without Handleguard (multi-pole units only)	yes
Front panel Snap-In, 0.96" wide bezel	
7 without Handleguard, 1-pole units 0.96" wide;	no
multipole units have .105" bezel overhang on all sides	
8 without Handleguard, 1-pole units 0.96" wide;	yes
(multi-pole units only).105" bezel overhang on all sides	

11 MAXIMUM APPLICATION RATING
M 80 DC

12 AGENCY APPROVAL
T UL489A Listed
K UL489A Listed, VDE Certified
J UL489A Listed, TUV Certified

- Notes:
- Actuator Code:
A: Handle tie pin spacer(s) and retainers provided unassembled with multi-pole units.
S: Handle moves to mid-position only upon electrical trip of the breaker.
T: Handle moves to mid-position and alarm switch activates only upon electrical trip of the breaker.
 - On multi-pole breakers, one auxiliary switch is supplied, mounted in the extreme right pole.
 - VDE Certification available with single pole breakers only. UL489A Listing available with one and two pole breakers.
 - Screw Terminals are recommended on ratings greater than 20 amps. Ratings over 30 amps are only available with Terminal Codes 5, 9, G, H, M and Q.
 - Terminal Code 1 (Push-On) available up to 25 amps with TUV or VDE Certification and 30 amps with UL489A Listing, but is not recommended over 20 amps.
 - Terminal Codes 3, 5 and H (Bus Type) with TUV or VDE, are supplied with Lock Washers, and Terminal Code M (M6 Threaded Stud) with TUV or VDE is supplied with Lock and Flat Washers. These breakers are only TUV or VDE Certified when the washers are used.
 - Single pole breakers with Terminal Code P (Printed Circuit Board) are available up to 30 amps with VDE Certification and 50 amps with UL489A Listing.
 - Terminal Code Q not available with VDE approvals.

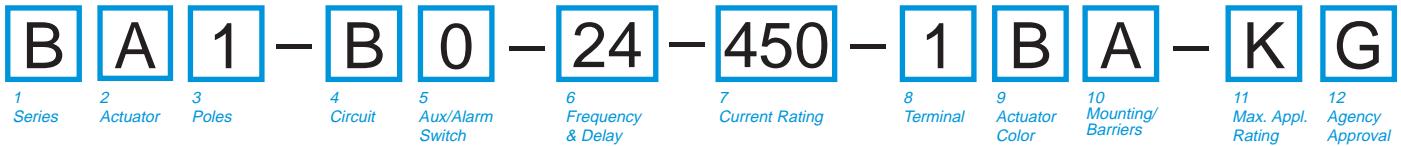

1 SERIES					
B					
2 ACTUATOR¹					
A Handle, one per pole					
B Handle, one per multi-pole unit					
S Mid-Trip Handle, one per pole					
T Mid-Trip Handle, one per pole & Alarm Switch					
3 POLES²					
1 One		2 Two		3 ³ Three	
4 CIRCUIT					
B Series Trip (Current)					
5 AUXILIARY/ALARM SWITCH⁴					
0 w/o Aux Switch		3 S.P.D.T., 0.139 Solder Lug			
1 S.P.D.T., 0.093 Q.C. Term.		8 S.P.S.T., 0.187 Q.C. Term.			
2 S.P.D.T., 0.110 Q.C. Term.		9 S.P.D.T., 0.187 Q.C. Term.			
6 FREQUENCY & DELAY					
21 AC Ultra Short		42 AC, Short, Hi-Inrush			
22 AC Short		44 AC, Medium, Hi-Inrush			
24 AC Medium		46 AC, Long, Hi-Inrush			
26 AC Long					
7 CURRENT RATING (AMPERES)					
210	0.100	512	1.250	495	9.500
215	0.150	415	1.500	610	10.000
220	0.200	517	1.750	710	10.500
225	0.250	420	2.000	611	11.000
230	0.300	522	2.250	711	11.500
235	0.350	527	2.750	612	12.000
240	0.400	430	3.000	712	12.500
245	0.450	435	3.500	613	13.000
250	0.500	440	4.000	614	14.000
255	0.550	445	4.500	615	15.000
260	0.600	450	5.000	616	16.000
265	0.650	455	5.500	617	17.000
270	0.700	460	6.000	618	18.000
275	0.750	465	6.500	620	20.000
280	0.800	470	7.000	622	22.000
285	0.850	475	7.500	624	24.000
290	0.900	480	8.000	625	25.000
295	0.950	485	8.500	630	30.000
410	1.000	490	9.000		

8 TERMINAL⁵			9		
1	Push-On 0.250 Tab (Q.C.)		30° bend		
2	Screw 8-32 w/upturned lugs	A	Load Terminal: #8 Screw/QC		
3	Screw 8-32 (Bus Type)		Combination. (Special Cat.#)		
4	Screw 10-32 w/upturned lugs	B	Screw M5 w/upturned lugs		
5	Screw 10-32 (Bus Type)	F	Screw M5 w/upturned lugs		
6	Screw 8-32 w/upturned lugs and 30° bend	G	Screw M5 (Bus Type) and 30° bend		
7	Screw 8-32 (Bus Type) and 30° bend	H	Screw M5 (Bus Type)		
8	Screw 10-32 w/upturned lugs and 30° bend	M	M6 Threaded Stud		
		Q	Push-In Stud		

9 ACTUATOR COLOR⁶			
LEGEND			
	ON-OFF	Dual	Legend Color
White	B	1	Black
Black	D	2	White
Red	G	3	White
Green	J	4	White
Blue	L	5	White
Yellow	N	6	Black
Gray	Q	7	Black
Orange	S	8	Black

10 MOUNTING/BARRIERS		
MOUNTING STYLE		BARRIERS ⁹
<i>Threaded Insert, 2 per pole</i>		
A	6-32 X 0.195 inches	yes
B	ISO M3 x 5mm	yes
<i>Rectangular Adapter Plate with mounting centers of 2.062 inches and Threaded insert, 2 per pole⁷</i>		
C	6-32 X 0.225 inches	yes
D	ISO M3 x 6.5mm	yes
<i>Front panel Snap-In, 0.75" wide bezel</i>		
6	without Handleguard	yes
<i>Front panel Snap-In, 0.96" wide bezel</i>		
8	without Handleguard, 1-pole units 0.96" wide; .105" bezel overhang on all sides	yes

11 MAXIMUM APPLICATION RATING	
C ⁸	120/240VAC
K	120VAC

12 AGENCY APPROVAL	
G	UL489 Listed
3	UL489 Listed, TUV Certified

- Notes:
- Actuator Code:
 A: Handle tie pin spacer(s) and retainers provided unassembled with multi-pole units.
 B: Handle location as viewed from front of breaker:
 2 pole - left pole 3 pole - center pole
 S: Handle moves to mid-position only upon electrical trip of the breaker. Available with circuit codes B, C, D, E, F, G, H and K.
 T: Handle moves to mid-position and alarm switch activates only upon electrical trip of the breaker. Available with circuit codes B & C.
 - All poles must be same polarity.
 - 3 pole units available only when 1 of 3 poles is neutral.
 - Auxiliary/Alarm Switch circuit must be same polarity as the main circuit. On multi-pole breakers, one aux. switch is supplied, mounted in the extreme right pole.
 - Screw Terminals are recommended on ratings greater than 20 amps.
 - Standard actuator colors are black and white.
 - Adapter plate with mounting centers of 2.082 inches. Available with Actuator Codes A, S and T.
 - Voltage Rating available with 2 and 3-pole breakers only.
 - Barriers supplied on multi-pole units only.

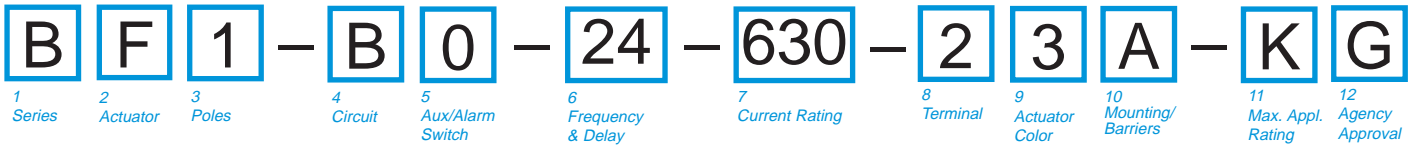

1 SERIES
B

2 ACTUATOR
Two Color Visi-Rocker

C Indicate ON, vertical legend
D Indicate ON, horizontal legend
F Indicate OFF, vertical legend
G Indicate OFF, horizontal legend

Single color
J Vertical legend
K Horizontal legend

Push-To-Reset, Visi-Rocker
N Indicate OFF, vertical legend
O Indicate OFF, horizontal legend

Push-To-Reset, Single color
R Vertical legend
U Horizontal legend

	INDICATE "ON"	INDICATE "OFF"	SINGLE COLOR
VERTICAL STYLE	CODE "C" 	CODE "F" 	CODE "J"
	CODE "D" 	CODE "G" 	CODE "K"

3 POLES^{1,2}
1 One 2 Two 3³ Three

4 CIRCUIT
B Series Trip (Current)

5 AUXILIARY/ALARM SWITCH⁴

0 w/o Aux Switch	7 S.P.S.T., 0.110 Q.C.
1 S.P.D.T., 0.093 Q.C. Term.	8 S.P.S.T., 0.187 Q.C. Term.
2 S.P.D.T., 0.110 Q.C. Term.	9 S.P.D.T., 0.187 Q.C. Term.
3 S.P.D.T., 0.139 Solder Lug	

6 FREQUENCY & DELAY

21 AC Ultra Short	42 AC, Short, Hi-Inrush
22 AC Short	44 AC, Medium, Hi-Inrush
24 AC Medium	46 AC, Long, Hi-Inrush
26 AC Long	

7 CURRENT RATING (AMPERES)

210	0.100	280	0.800	445	4.500	711	11.500
215	0.150	285	0.850	450	5.000	612	12.000
220	0.200	290	0.900	455	5.500	712	12.500
225	0.250	295	0.950	460	6.000	613	13.000
230	0.300	410	1.000	465	6.500	614	14.000
235	0.350	512	1.250	470	7.000	615	15.000
240	0.400	415	1.500	475	7.500	616	16.000
245	0.450	517	1.750	480	8.000	617	17.000
250	0.500	420	2.000	485	8.500	618	18.000
255	0.550	522	2.250	490	9.000	620	20.000
260	0.600	527	2.750	495	9.500	622	22.000
265	0.650	430	3.000	610	10.000	624	24.000
270	0.700	435	3.500	710	10.500	625	25.000
275	0.750	440	4.000	611	11.000	630	30.000

8 TERMINAL⁵

1 ⁶ Push-On 0.250 Tab (Q.C.)	9 Screw 10-32 (Bus Type) and 30° bend
2 Screw 8-32 w/upturned lugs	B Screw M5 w/upturned lugs
3 Screw 8-32 (Bus Type)	C Screw M4 w/upturned lugs
4 Screw 10-32 w/upturned lugs	F Screw M5 w/upturned lugs and 30° bend
5 Screw 10-32 (Bus Type)	G Screw M5 (Bus Type) and 30° bend
6 Screw 8-32 w/upturned lugs and 30° bend	H Screw M5 (Bus Type)
7 Screw 8-32 (Bus Type) and 30° bend	
8 Screw 10-32 w/upturned lugs and 30° bend	

9 ACTUATOR COLOR & LEGEND
*Actuator or Visi-Color*⁷

	Marking		Marking Color:	
	ON-OFF	Dual ⁷	Single Color	Visi-Rocker
White	B	1	Black	White
Black	D	2	White	n/a
Red	G	3	White	Red
Green	J	4	White	Green
Blue	L	5	White	Blue
Yellow	N	6	Black	Yellow
Gray	Q	7	Black	Gray
Orange	S	8	Black	Orange

10 MOUNTING/BARRIERS

	STANDARD ROCKER BEZEL	BARRIERS ⁹
	<i>Threaded Insert, 2 per pole</i>	
A	6-32 X 0.195 inches	yes
B	ISO M3 x 5mm	yes
	ROCKERGUARD BEZEL	
	<i>Threaded Insert, 2 per pole</i>	
C	6-32 x 0.195 inches	yes
D	ISO M3 x 5mm	yes

11 MAXIMUM APPLICATION RATING

C ⁸	120/240 VAC
K	120 VAC

11 AGENCY APPROVAL
G UL489 Listed

Notes:
 1 Multi-pole breakers have all breakers identical except when specifying Aux. switch and/or mixed poles, and have one rocker per breaker.
 2 All poles must be same polarity.
 3 3 pole units available only when 1 of 3 poles is neutral.
 4 On multi-pole breakers, one aux. switch is supplied, mounted in the extreme right pole.
 5 Screw Terminals are recommended on ratings greater than 20 amps.
 6 Terminal Code 1 (Push-On) available up to 30 amps, but are not recommended over 20 amps.
 7 Dual legend = ON-OFF/I-O
 8 Voltage Rating available with 2 and 3-pole breakers only.
 9 Barriers supplied on multi-pole units only.

	CIRCUIT SCHEMATIC		CIRCUIT CODE	AUX. SWITCH CODE	CIRCUIT SCHEMATIC		CIRCUIT CODE	AUX. SWITCH CODE
	ANSI	IEC			ANSI	IEC		
	SWITCH ONLY (NO COIL)				SERIES TRIP			
<p>SERIES TRIP (2 TERM'S.)</p> <p>MAIN TERM'S. (SEE TABLE A)</p>			A	O			B C	O
<p>SERIES TRIP W AUX SWITCH (5 TERM'S.)</p> <p>AUX. SWITCH TERM'S.</p>	<p>SWITCH ONLY (NO COIL) WITH AUXILIARY SWITCH</p>		A	2 3 4	<p>SERIES TRIP WITH AUXILIARY / ALARM SWITCH</p>		B C	2 3 4
<p>SHUNT TRIP (3 TERM'S.)</p>	<p>SHUNT TRIP</p>		D E	0	<p>DUAL COIL: SERIES TRIP CURRENT COIL, SHUNT TRIP VOLTAGE COIL</p>		H	0
<p>RELAY TRIP (4 TERM'S.)</p>	<p>RELAY TRIP</p>		F G	0	<p>DUAL COIL: SERIES TRIP CURRENT COIL, RELAY TRIP VOLTAGE COIL</p>		K	0

Notes:

- 1 All dimensions are in inches [millimeters].
- 2 Tolerance ±.020 [.51] unless otherwise specified.
- 3 Alarm Switch available with .110 x .020 Q.C. & Solder Lug Terminals Only.

HANDLE POSITION VS. AUX/ALARM SWITCH MODE						
CIRCUIT BREAKER MODE	STANDARD C/R		MID TRIP C/R		MID TRIP C/R	
	HANDLE POSITION	AUX. SWITCH MODE	HANDLE POSITION	ALARM SWITCH MODE	HANDLE POSITION	AUX. SWITCH MODE (w/o ALARM SWITCH)
OFF						
ON						
ELECTRICAL TRIP						

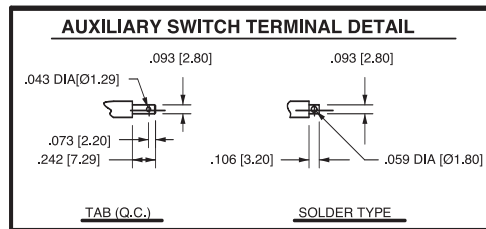
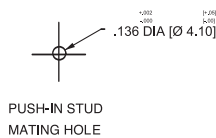
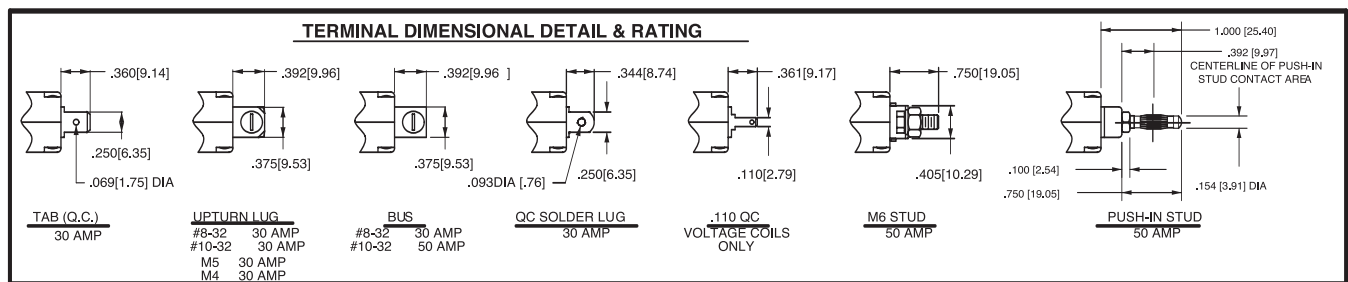

**TABLE A
TIGHTENING TORQUE SPECIFICATIONS**

THREAD SIZE	TORQUE
#6-32 & M3 MOUNTING HARDWARE	7-9 IN-LBS [0.8-1.0 NM]
#8-32 & M4 THREAD TERMINAL SCREW	12-15 IN-LBS [1.4-1.7 NM]
#10-32 & M5 THREAD TERMINAL SCREW	15-20 IN-LBS [1.7-2.3 NM]

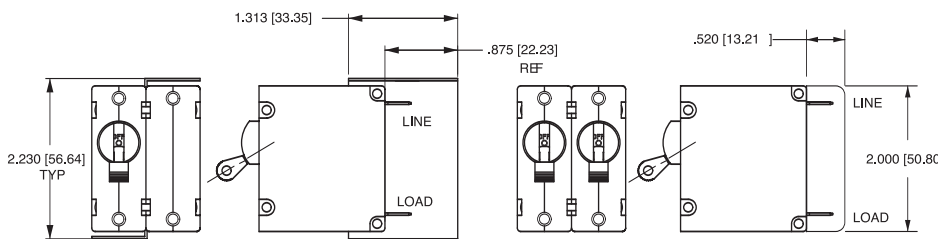

BARRIER FOR UL-489 MULTI-POLE BREAKERS

BARRIER FOR UL-RECOGNIZED MULTI-POLE BREAKERS

TABLE B

TERMINAL DESCRIPTION	DEPTH BEHIND PANEL
MAIN TAB (Q.C.)	2.090 [53.09]
MAIN SCREW TYPE	2.122 [53.90]
SHUNT, RELAY & DUAL COIL TAB (Q.C.)	2.612 [66.35]
SHUNT, RELAY & DUAL COIL SCREW #8-32 W/UPTURNED LUGS	2.644 [67.16]
AUX. SWITCH* TAB (Q.C.) .110 x .020	2.537 [64.44]
AUX. SWITCH* SOLDER TYPE	2.348 [59.64]

* AVAILABLE ON SERIES TRIP AND SWITCH ONLY CIRCUITS WHEN CALLED FOR ON MULTI-POLE UNITS. ONLY ONE AUX. SWITCH IS NORMALLY SUPPLIED, AS SHOWN IN MULTI-POLE IDENTIFICATION SCHEME

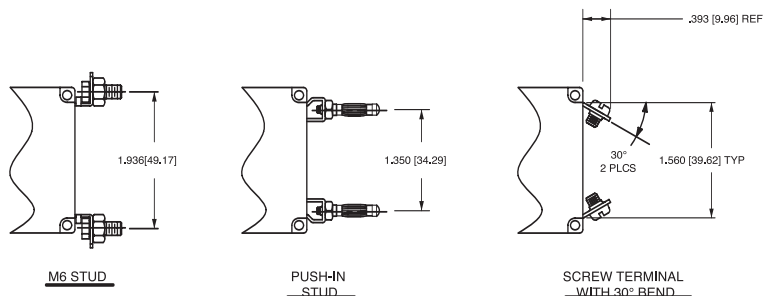
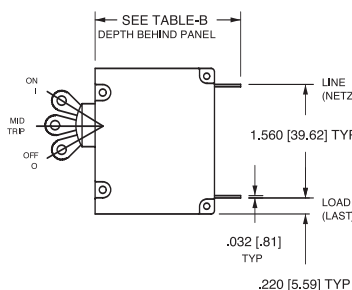

- Notes:
- All dimensions are in inches [millimeters].
 - Tolerance ± 0.020 [.51] unless otherwise specified.

B-Series Handle – Front Panel Snap-In Mounting Style 5

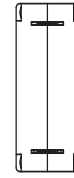
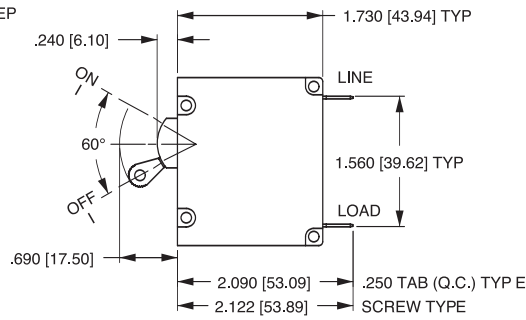
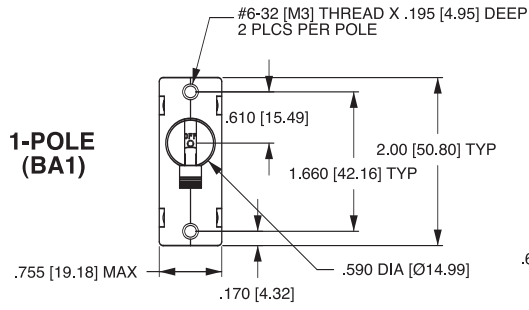

TAB (Q.C.) TYPE TERMINALS IN SERIES TRIP CIRCUIT CONFIGURATION SHOWN. FOR OTHER CONFIGURATIONS, SEE CIRCUIT AND TERMINAL DRAWINGS.

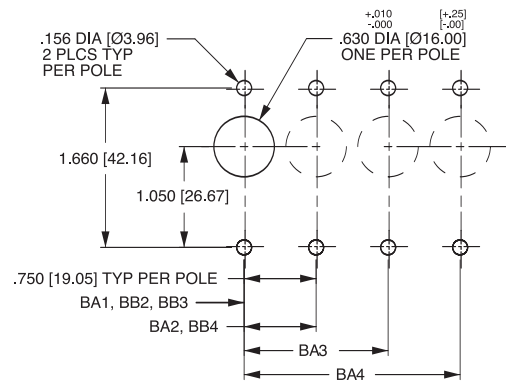
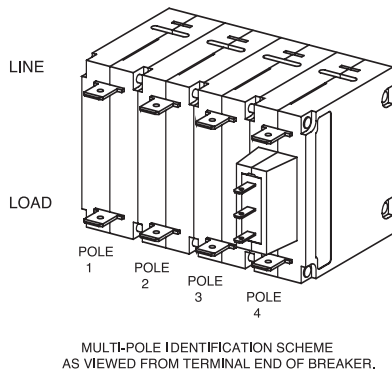
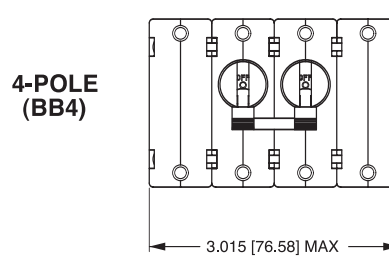
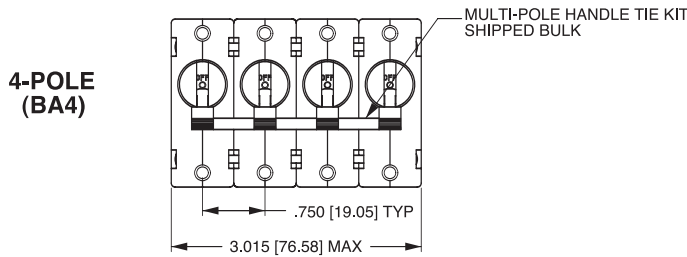
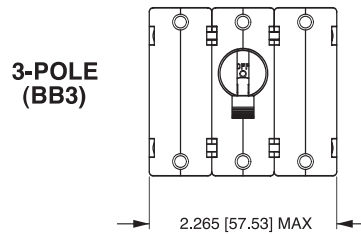
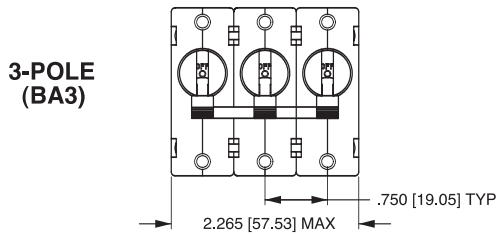
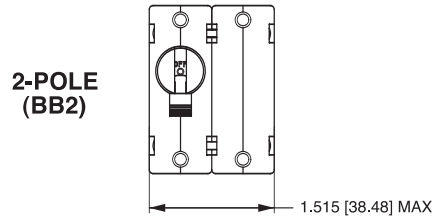
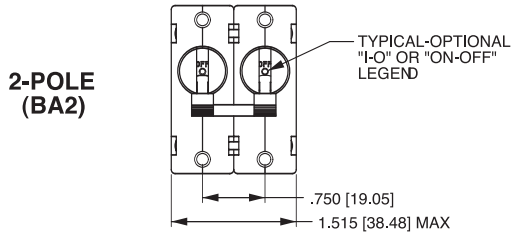

PANEL CUTOUT DETAIL
TOLERANCES ±.005 [±.12]

- Notes:
- All dimensions are in inches [millimeters].
 - Tolerance ±.020 [.51] unless otherwise specified.

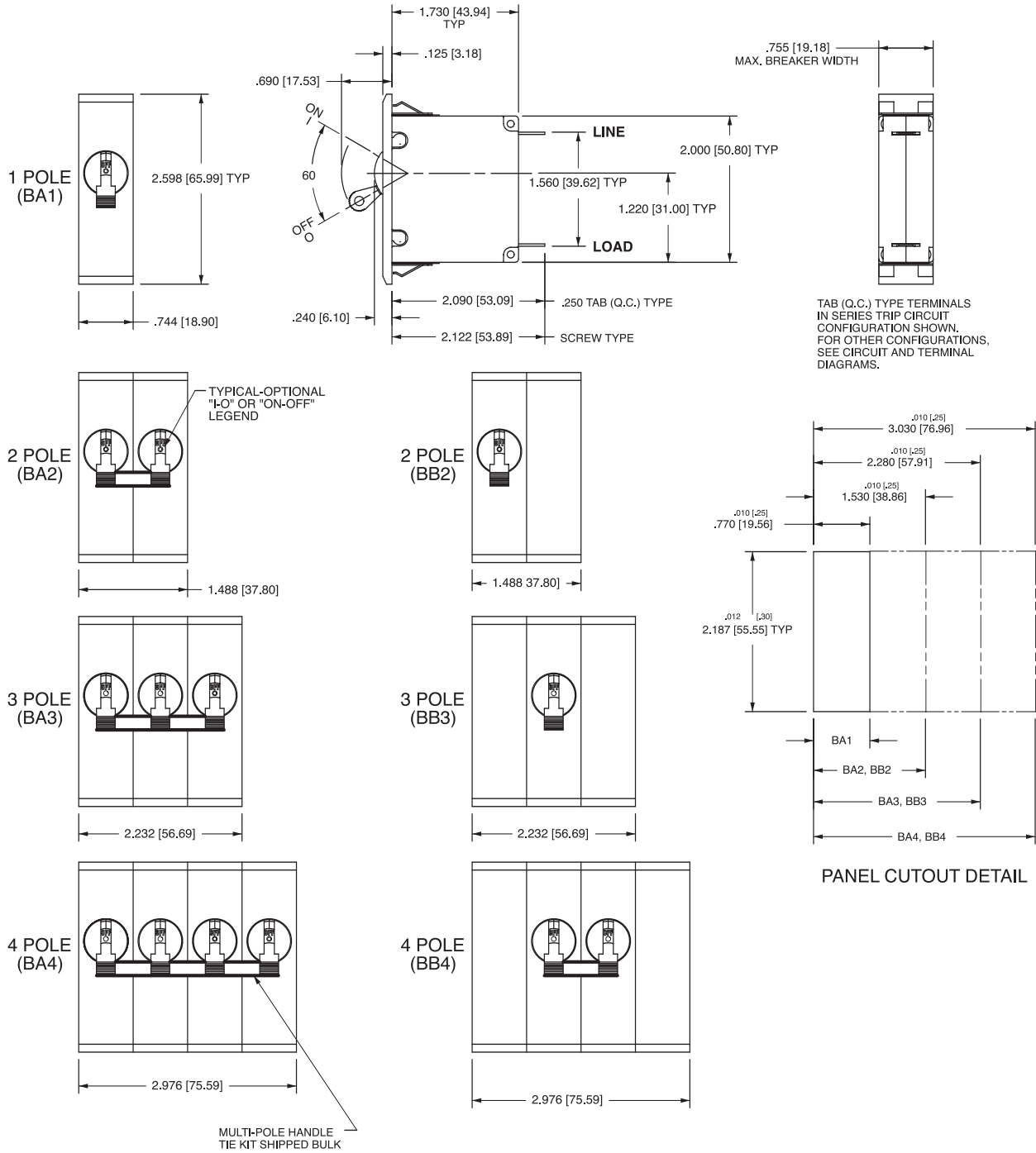

Notes:

- 1 All dimensions are in inches [millimeters].
- 2 Recommended panel thickness: .040 [1.02] to .100 [2.54].
- 3 Tolerance ±.020 [.51] unless otherwise specified.

B-Series Handle – Front Panel Snap-In Mounting Style 7

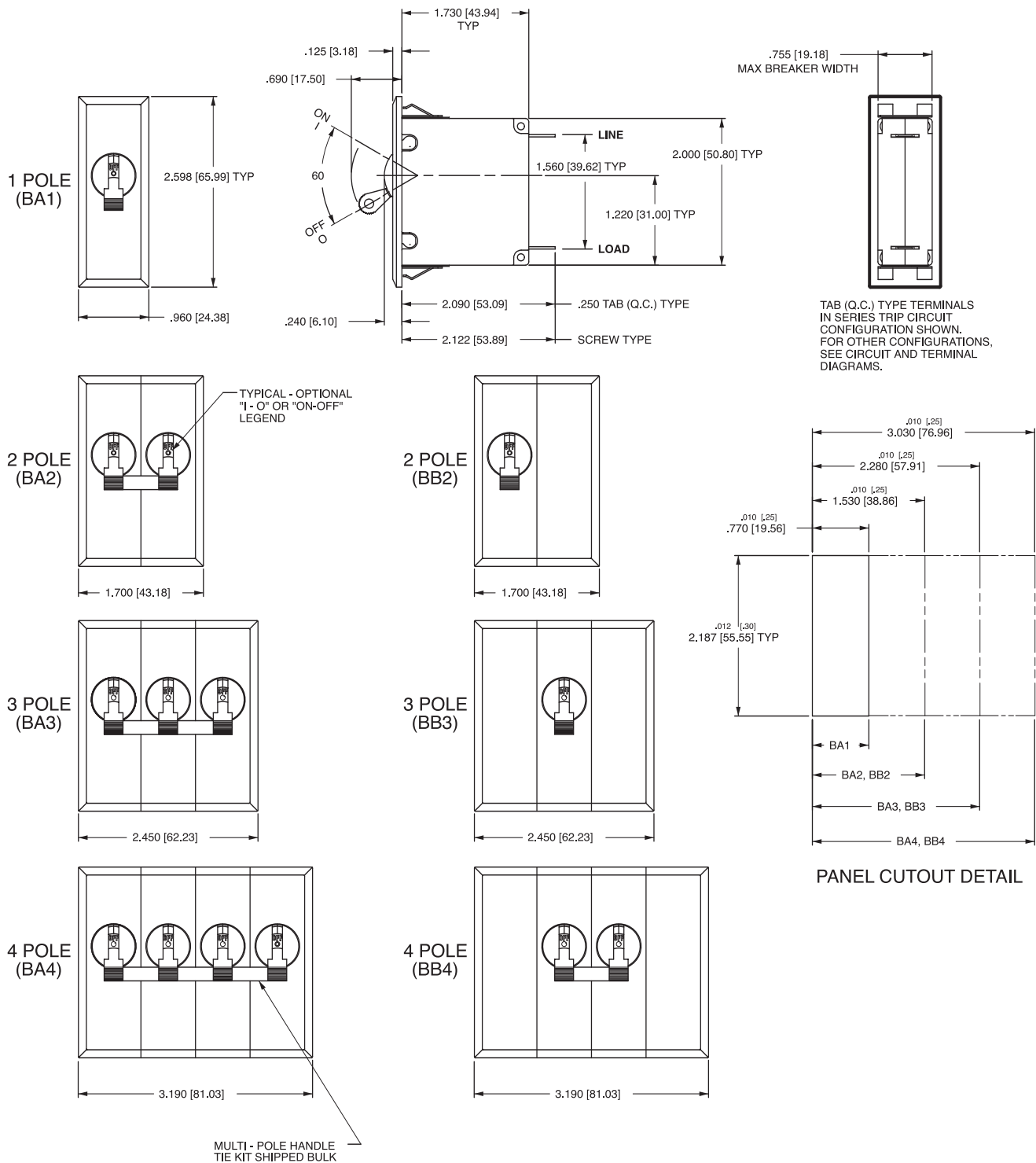

- Notes:
- 1 All dimensions are in inches [millimeters].
 - 2 Recommended panel thickness .040 [1.02] to .100 [2.54].
 - 3 Tolerance ±.020 [.51] unless otherwise specified.

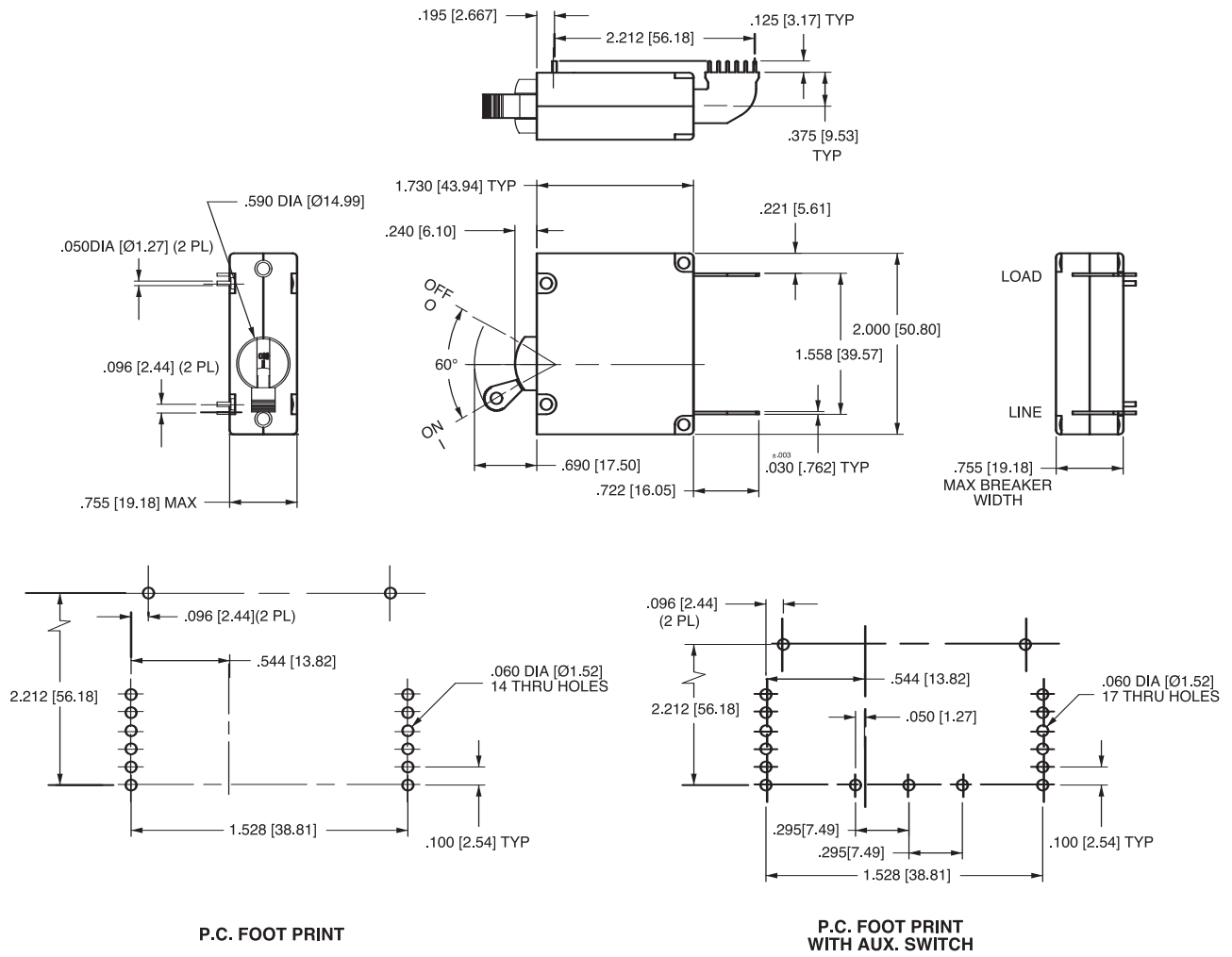

Notes:

- 1 All dimensions are in inches [millimeters].
- 2 For pole orientation with horizontal legend, rotate front view clockwise 90°.
- 3 Tolerance ±.010 [.25] unless otherwise specified.

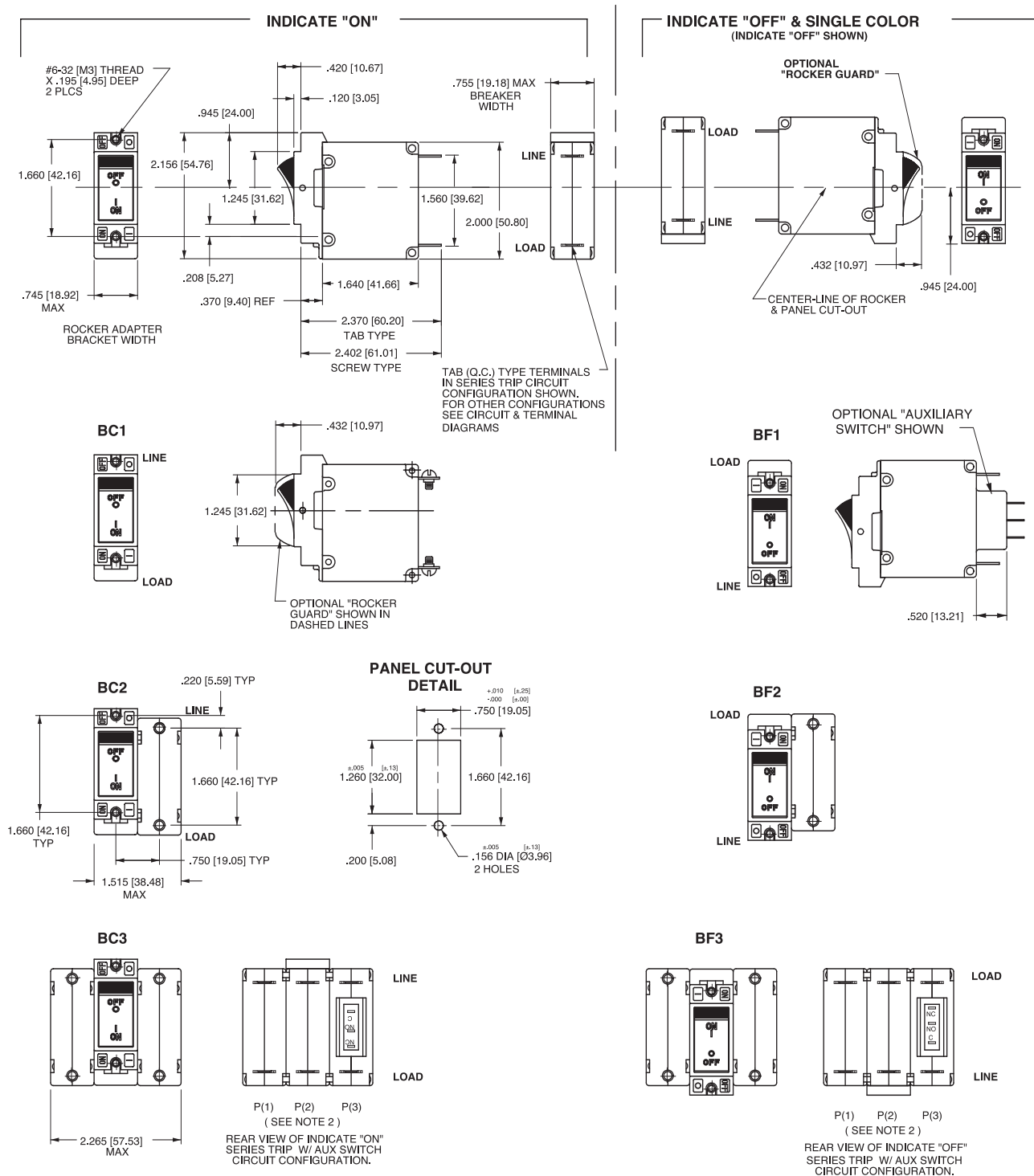

- Notes:
- 1 Dimensions apply to all variations shown. Notice that circuit breaker line & load terminal orientation on indicate "OFF" is opposite of indicate "ON".
 - 2 For pole orientation with horizontal legend, rotate front view clockwise 90°.
 - 3 All dimensions are in inches [millimeters].
 - 4 Tolerance $\pm .020$ [.51] unless otherwise specified.

INDICATE "OFF" & SINGLE COLOR
(INDICATE "OFF" SHOWN)

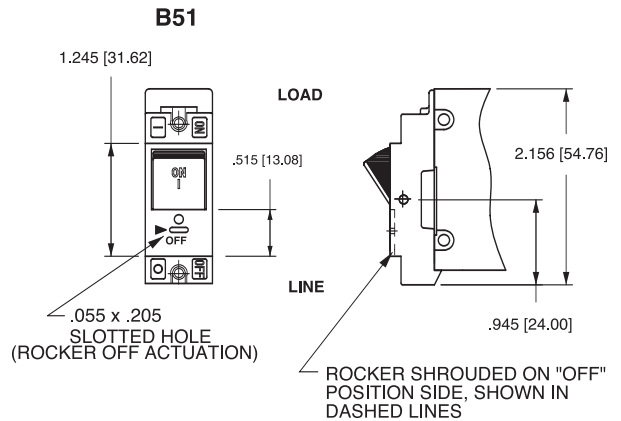
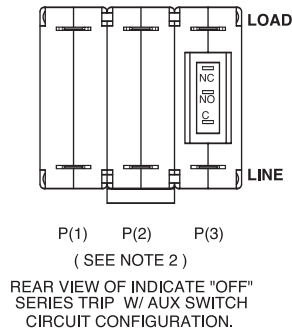
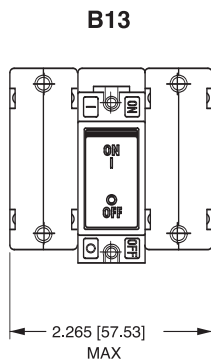
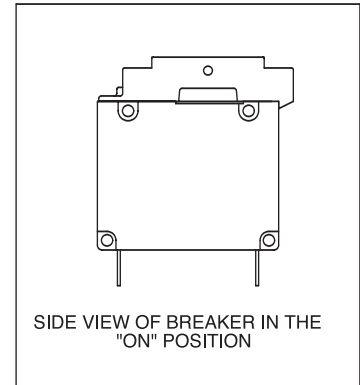
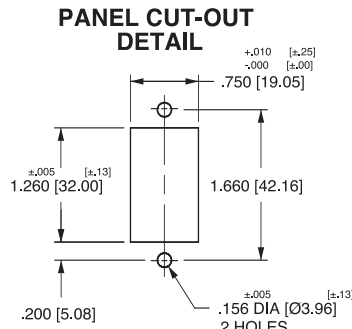
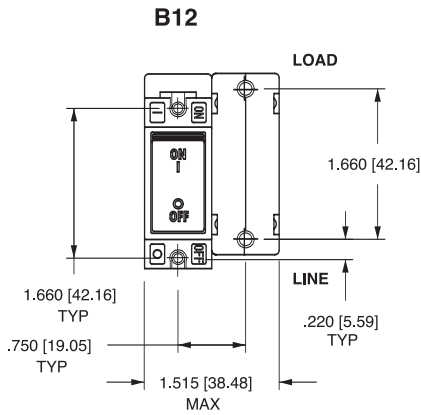
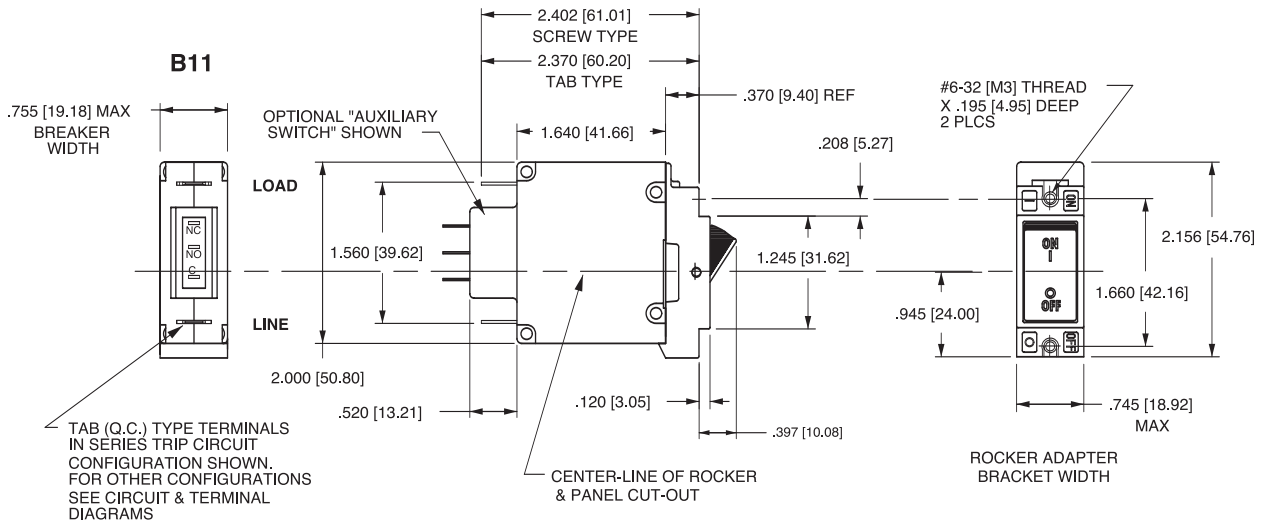

ACTUATOR SIDE VIEW
(SURFACE CONTOURS)

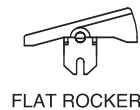

Notes:

- 1 All dimensions are in inches [millimeters].
- 2 For pole orientation with horizontal legend, rotate front view clockwise 90°.
- 3 Tolerance $\pm .020$ [.51] unless otherwise specified.