

CHIP COIL (CHIP INDUCTORS) LQW15AN□□□□00D Reference Specification

1.Scope

This Reference Specification applies to LQW15AN_00 series, Chip coil (Chip Inductors).

2.Part Numbering

(ex)	LQ	W	15	A	N	1N5	B	0	0	D
	Product ID	Structure	Dimension (L×W)	Applications and Characteristics	Category	Inductance	Tolerance	Features	Electrode	Packaging D:Taping *B:Bulk

* Bulk packing also available. (A product is put in the plastic bag under the taping conditions.)

3.Rating

- Operating Temperature Range. $-55^{\circ}\text{C} \sim +125^{\circ}\text{C}$
- Storage Temperature Range. $-55^{\circ}\text{C} \sim +125^{\circ}\text{C}$

Customer Part Number	MURATA Part Number	Inductance		Q (min.)	DC Resistance (Ω max.)	Self Resonant Frequency (GHz min.)	Rated Current (mA)	
		(nH)	Tolerance					
	LQW15AN1N5B00D	1.5	B:±0.1nH C:±0.2nH D:±0.5nH	10	0.03	18.0	1000	
	LQW15AN1N5C00D							
	LQW15AN1N5D00D							
	LQW15AN1N6C00D	1.6	C:±0.2nH D:±0.5nH		0.07	17.0	750	
	LQW15AN1N6D00D							
	LQW15AN1N7C00D	1.7			0.10		640	
	LQW15AN1N7D00D							
	LQW15AN1N8C00D	1.8			0.16	16.0	460	
	LQW15AN1N8D00D							
	LQW15AN2N4B00D	2.4		B:±0.1nH C:±0.2nH D:±0.5nH	20	0.05	15.0	850
	LQW15AN2N4C00D							
	LQW15AN2N4D00D							
	LQW15AN2N5B00D	2.5	0.07			750		
	LQW15AN2N5C00D							
	LQW15AN2N5D00D							
	LQW15AN2N6B00D	2.6	0.13			570		
	LQW15AN2N6C00D							
	LQW15AN2N6D00D							
	LQW15AN2N7B00D	2.7	0.17	500				
	LQW15AN2N7C00D							
	LQW15AN2N7D00D							
	LQW15AN2N8B00D	2.8	0.20	460				
	LQW15AN2N8C00D							
	LQW15AN2N8D00D							
	LQW15AN2N9B00D	2.9	0.25	400				
	LQW15AN2N9C00D							
	LQW15AN2N9D00D							
	LQW15AN3N0B00D	3.0	0.30	350				
	LQW15AN3N0C00D							
	LQW15AN3N0D00D							
	LQW15AN3N1B00D	3.1	0.35	300				
	LQW15AN3N1C00D							
	LQW15AN3N1D00D							
	LQW15AN3N2B00D	3.2	0.40	250				
	LQW15AN3N2C00D							
	LQW15AN3N2D00D							
	LQW15AN3N9B00D	3.9	0.50	200				
	LQW15AN3N9C00D							
	LQW15AN3N9D00D							
	LQW15AN4N1B00D	4.1	0.60	150				
	LQW15AN4N1C00D							
	LQW15AN4N1D00D							
	LQW15AN4N3B00D	4.3	0.70	100				
	LQW15AN4N3C00D							
	LQW15AN4N3D00D							

Customer Part Number	MURATA Part Number	Inductance		Q (min.)	DC Resistance (Ω max.)	Self Resonant Frequency (GHz min.)	Rated Current (mA)
		(nH)	Tolerance				
	LQW15AN4N4B00D	4.4	B: ± 0.1 nH C: ± 0.2 nH D: ± 0.5 nH	25	0.07	8.0	750
	LQW15AN4N4C00D						
	LQW15AN4N4D00D						
	LQW15AN4N5B00D	4.5					
	LQW15AN4N5C00D						
	LQW15AN4N5D00D						
	LQW15AN4N6B00D	4.6					
	LQW15AN4N6C00D						
	LQW15AN4N6D00D						
	LQW15AN4N7B00D	4.7					
	LQW15AN4N7C00D						
	LQW15AN4N7D00D						
	LQW15AN4N8B00D	4.8					
	LQW15AN4N8C00D						
	LQW15AN4N8D00D						
	LQW15AN4N9B00D	4.9					
	LQW15AN4N9C00D						
	LQW15AN4N9D00D						
	LQW15AN5N0B00D	5.0					
	LQW15AN5N0C00D						
	LQW15AN5N0D00D						
	LQW15AN5N1B00D	5.1					
	LQW15AN5N1C00D						
	LQW15AN5N1D00D						
	LQW15AN5N8B00D	5.8					
	LQW15AN5N8C00D						
	LQW15AN5N8D00D						
	LQW15AN6N2B00D	6.2					
	LQW15AN6N2C00D						
	LQW15AN6N2D00D						
	LQW15AN6N3B00D	6.3					
	LQW15AN6N3C00D						
	LQW15AN6N3D00D						
	LQW15AN6N4B00D	6.4					
	LQW15AN6N4C00D						
	LQW15AN6N4D00D						
	LQW15AN6N5B00D	6.5					
	LQW15AN6N5C00D						
	LQW15AN6N5D00D						
	LQW15AN6N6B00D	6.6					
	LQW15AN6N6C00D						
	LQW15AN6N6D00D						
	LQW15AN6N7B00D	6.7					
	LQW15AN6N7C00D						
	LQW15AN6N7D00D						
	LQW15AN6N8G00D	6.8					
	LQW15AN6N8H00D						
	LQW15AN6N8J00D						
	LQW15AN6N9G00D	6.9					
	LQW15AN6N9H00D						
	LQW15AN6N9J00D						
	LQW15AN7N0G00D	7.0	G: $\pm 2\%$ H: $\pm 3\%$ J: $\pm 5\%$	0.13	6.0	570	
	LQW15AN7N0H00D						
	LQW15AN7N0J00D						
	LQW15AN7N1G00D						
	LQW15AN7N1H00D						
	LQW15AN7N1J00D						
	LQW15AN7N2G00D	7.2					
	LQW15AN7N2H00D						
	LQW15AN7N2J00D						

Customer Part Number	MURATA Part Number	Inductance		Q (min.)	DC Resistance (Ω max.)	Self Resonant Frequency (GHz min.)	Rated Current (mA)
		(nH)	Tolerance				
	LQW15AN7N3G00D	7.3			0.13	6.0	570
	LQW15AN7N3H00D						
	LQW15AN7N3J00D						
	LQW15AN7N5G00D	7.5					
	LQW15AN7N5H00D						
	LQW15AN7N5J00D						
	LQW15AN8N2G00D	8.2					
	LQW15AN8N2H00D						
	LQW15AN8N2J00D						
	LQW15AN8N6G00D	8.6					
	LQW15AN8N6H00D						
	LQW15AN8N6J00D						
	LQW15AN8N7G00D	8.7					
	LQW15AN8N7H00D						
	LQW15AN8N7J00D						
	LQW15AN8N8G00D	8.8					
	LQW15AN8N8H00D						
	LQW15AN8N8J00D						
	LQW15AN8N9G00D	8.9					
	LQW15AN8N9H00D						
	LQW15AN8N9J00D						
	LQW15AN9N0G00D	9.0					
	LQW15AN9N0H00D						
	LQW15AN9N0J00D						
	LQW15AN9N1G00D	9.1					
	LQW15AN9N1H00D						
	LQW15AN9N1J00D						
	LQW15AN9N2G00D	9.2		25	0.14	5.5	540
	LQW15AN9N2H00D						
	LQW15AN9N2J00D						
	LQW15AN9N3G00D	9.3					
	LQW15AN9N3H00D						
	LQW15AN9N3J00D						
	LQW15AN9N4G00D	9.4					
	LQW15AN9N4H00D						
	LQW15AN9N4J00D						
	LQW15AN9N5G00D	9.5					
	LQW15AN9N5H00D						
	LQW15AN9N5J00D						
	LQW15AN9N6G00D	9.6					
	LQW15AN9N6H00D						
	LQW15AN9N6J00D						
	LQW15AN9N7G00D	9.7					
	LQW15AN9N7H00D						
	LQW15AN9N7J00D						
	LQW15AN9N8G00D	9.8					
	LQW15AN9N8H00D						
	LQW15AN9N8J00D						
	LQW15AN9N9G00D	9.9					
	LQW15AN9N9H00D						
	LQW15AN9N9J00D						
	LQW15AN10NG00D	10			0.17		
	LQW15AN10NH00D						
	LQW15AN10NJ00D						
	LQW15AN11NG00D	11		30	0.14		500
	LQW15AN11NH00D						
	LQW15AN11NJ00D						
	LQW15AN12NG00D	12					
	LQW15AN12NH00D						
	LQW15AN12NJ00D						

Customer Part Number	MURATA Part Number	Inductance		Q (min.)	DC Resistance (Ω max.)	Self Resonant Frequency (GHz min.)	Rated Current (mA)
		(nH)	Tolerance				
	LQW15AN13NG00D	13	G: \pm 2% H: \pm 3% J: \pm 5%	25	0.21	5.0	430
	LQW15AN13NH00D						
	LQW15AN13NJ00D						
	LQW15AN15NG00D	15		30	0.16		460
	LQW15AN15NH00D						
	LQW15AN15NJ00D						
	LQW15AN16NG00D	16			0.24		370
	LQW15AN16NH00D						
	LQW15AN16NJ00D						
	LQW15AN18NG00D	18			0.27	4.5	310
	LQW15AN18NH00D						
	LQW15AN18NJ00D						
	LQW15AN19NG00D	19			0.30	4.0	280
	LQW15AN19NH00D						
	LQW15AN19NJ00D						
	LQW15AN20NG00D	20		0.52	3.5	270	
	LQW15AN20NH00D						
	LQW15AN20NJ00D						
	LQW15AN22NG00D	22		0.63	3.2	260	
	LQW15AN22NH00D						
	LQW15AN22NJ00D						
	LQW15AN23NG00D	23		0.70	3.8	250	
	LQW15AN23NH00D						
	LQW15AN23NJ00D						
	LQW15AN24NG00D	24		1.08	2.9	210	
	LQW15AN24NH00D						
	LQW15AN24NJ00D						
	LQW15AN27NG00D	27		1.17	2.8	200	
	LQW15AN27NH00D						
	LQW15AN27NJ00D						
	LQW15AN30NG00D	30		1.82	2.6	145	
	LQW15AN30NH00D						
	LQW15AN30NJ00D						
	LQW15AN33NG00D	33					
	LQW15AN33NH00D						
	LQW15AN33NJ00D						
	LQW15AN36NG00D	36					
	LQW15AN36NH00D						
	LQW15AN36NJ00D						
	LQW15AN39NG00D	39					
	LQW15AN39NH00D						
	LQW15AN39NJ00D						
	LQW15AN40NG00D	40					
	LQW15AN40NH00D						
	LQW15AN40NJ00D						
	LQW15AN43NG00D	43					
	LQW15AN43NH00D						
	LQW15AN43NJ00D						
	LQW15AN47NG00D	47					
	LQW15AN47NH00D						
	LQW15AN47NJ00D						
	LQW15AN51NG00D	51					
	LQW15AN51NH00D						
	LQW15AN51NJ00D						
	LQW15AN56NG00D	56					
	LQW15AN56NH00D						
	LQW15AN56NJ00D						
	LQW15AN62NG00D	62					
	LQW15AN62NH00D						
	LQW15AN62NJ00D						

Customer Part Number	MURATA Part Number	Inductance		Q (min.)	DC Resistance (Ω max.)	Self Resonant Frequency (GHz min.)	Rated Current (mA)
		(nH)	Tolerance				
	LQW15AN68NG00D	68	G:±2% J:±5%	20	1.96	2.5	140
	LQW15AN68NJ00D						
	LQW15AN72NG00D	72			135		
	LQW15AN72NJ00D						
	LQW15AN75NG00D	75			2.4		
	LQW15AN75NJ00D						
	LQW15AN82NG00D	82			2.3		
	LQW15AN82NJ00D						
	LQW15AN91NG00D	91			2.1		
	LQW15AN91NJ00D						
	LQW15ANR10J00D	100	J:±5%		2.52	1.5	120
	LQW15ANR12J00D	120			2.66	1.0	110

4. Testing Conditions

《Unless otherwise specified》

Temperature : Ordinary Temperature / 15°C to 35°C
 Humidity : Ordinary Humidity / 25%(RH) to 85%(RH)

《In case of doubt》

Temperature : 20°C±2°C
 Humidity : 60%(RH) to 70%(RH)
 Atmospheric Pressure : 86kPa to 106 kPa

5. Appearance and Dimensions

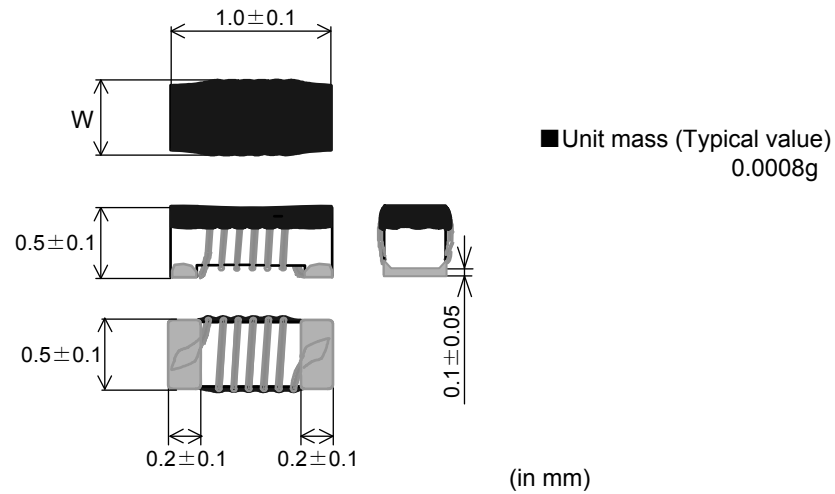

*Dimension of W

Inductance	W (in mm)
1N5~23N	0.6±0.1
24N~R12	0.5±0.1

6.Electrical Performance

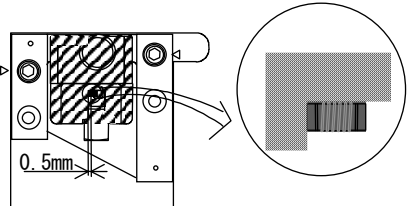
No.	Item	Specification	Test Method
6.1	Inductance	Inductance shall meet item 3.	Measuring Equipment: KEYSIGHT E4991A or equivalent Measuring Frequency: <Inductance> 100MHz <Q> 250MHz/ 1.5nH~43nH 200MHz/ 47nH~68nH 150MHz/ 72nH~120nH Measuring Condition: Test signal level / about 0dBm Electrical length / 0.94cm Measuring Fixture: KEYSIGHT 16193A Position coil under test as shown in below and contact coil with each terminal by adding weight.
6.2	Q	Q shall meet item 3.	 Measuring Method: See the endnote. <Electrical Performance:Measuring Method of Inductance/Q>
6.3	DC Resistance	DC Resistance shall meet item 3.	Measuring Equipment:Digital multi meter
6.4	Self Resonant Frequency(S.R.F)	S.R.F shall meet item 3.	Measuring Equipment:KEYSIGHT N5230A or equivalent
6.5	Rated Current	Self temperature rise shall be limited to 20°C max.	The rated current is applied.

7.Mechanical Performance

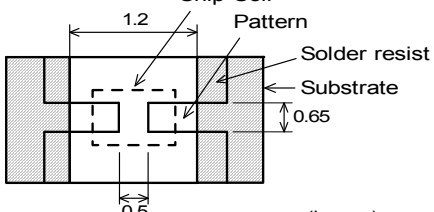
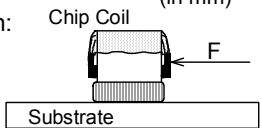
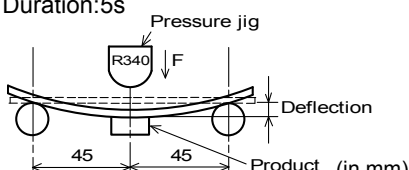
No.	Item	Specification	Test Method
7.1	Shear Test	Chip coil shall not be damaged after tested as test method.	Substrate:Glass-epoxy substrate Chip Coil  Applied Direction:  Force:5N Hold Duration:5s±1s
7.2	Bending Test		Substrate:Glass-epoxy substrate (100mm × 40mm × 0.8mm) Speed of Applying Force:1mm / s Deflection:2mm Hold Duration:5s 

No.	Item	Specification	Test Method
7.3	Vibration	Chip coil shall not be damaged after tested as test method.	Oscillation Frequency: 10Hz~55Hz~10Hz for 1 min Total Amplitude:1.5mm Testing Time: A period of 2 hours in each of mutually perpendicular directions.
7.4	Solderability	The wetting area of the electrode shall be at least 90% covered with new solder coating.	Flux:Ethanol solution of rosin,25(wt)% Includes activator equivalent to 0.06(wt)% chlorine.(immersed for 5s to 10s) Solder:Sn-3.0Ag-0.5Cu Pre-Heating:150°C±10°C / 60s to 90s Solder Temperature:240°C±5°C Immersion Time:3s±1s
7.5	Resistance to Soldering Heat	Appearance:No damage Inductance Change: within ±5%	Flux:Ethanol solution of rosin,25(wt)% Includes activator equivalent to 0.06(wt)% Chlorine.(immersed for 5s to 10s) Solder:Sn-3.0Ag-0.5Cu Pre-Heating:150°C±10°C / 60s to 90s Solder Temperature:270°C±5°C Immersion Time:10s±1s Then measured after exposure in the room condition for 24h±2h.

8.Environmental Performance

It shall be soldered on the substrate.

No.	Item	Specification	Test Method
8.1	Heat Resistance	Appearance:No damage Inductance Change: within ±5% Q Change: within ±20%	Temperature:125°C±2°C Time:1000h (+48h,0h) Then measured after exposure in the room condition for 24h±2h.
8.2	Cold Resistance		Temperature:-55°C±2°C Time:1000h (+48h,-0h) Then measured after exposure in the room condition for 24h±2 h.
8.3	Humidity		Temperature:70°C±2°C Humidity:90%(RH) to 95%(RH) Time:1000h (+48h,-0h) Then measured after exposure in the room condition for 24h±2h.
8.4	Temperature Cycle		1 cycle: 1 step:-55°C±2°C / 30min±3 min 2 step:Ordinary temp. / 10min to 15 min 3 step:+125°C±2°C / 30min±3 min 4 step:Ordinary temp. / 10min to 15 min Total of 10 cycles Then measured after exposure in the room condition for 24h±2h.

9.Specification of Packaging

9.1 Appearance and Dimensions of paper tape (8mm-wide)

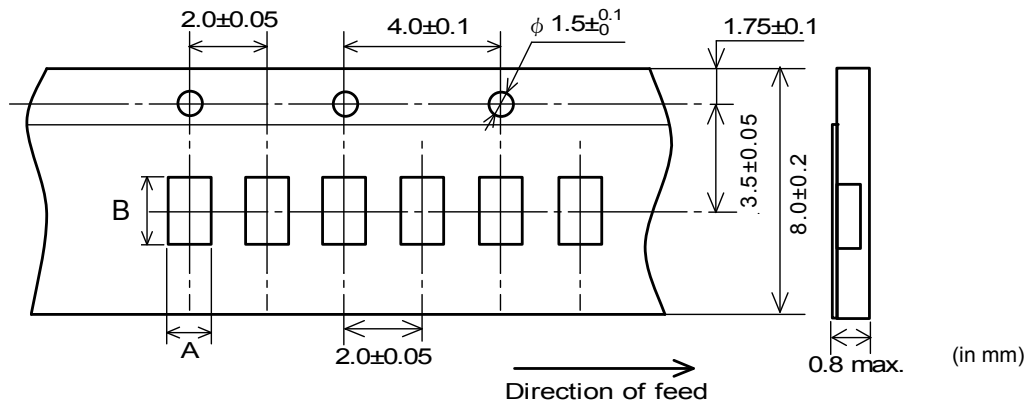

Inductance	A* (mm) (Tolerance ±0.03)	B* (mm) (Tolerance ±0.03)
1N5, 2N4~2N8, 3N9~4N8, 5N8~6N8, 8N2~9N9, 11N, 12N, 15N	0.69	1.18
1N6~1N8, 2N9, 3N0, 3N1, 3N2, 4N9~5N1, 6N9-7N5, 10N, 13N, 16N~23N, R10, R12	0.66	1.18
24N~91N	0.64	1.18

* Typical value

9.2 Specification of Taping

- (1) Packing quantity (standard quantity)
10,000 pcs. / reel
- (2) Packing Method
Products shall be packed in the cavity of the base tape and sealed by Cover tape.
- (3) Sprocket hole
The sprocket holes are to the right as the tape is pulled toward the user.
- (4) Spliced point
Base tape and Cover tape has no spliced point.
- (5) Missing components number
Missing components number within 0.1% of the number per reel or 1 pc., whichever is greater, and are not continuous. The Specified quantity per reel is kept.

9.3 Pull Strength

Cover tape	5N min.
------------	---------

9.4 Peeling off force of cover tape

Speed of Peeling off	300mm/min
Peeling off force	0.1 to 0.6N (minimum value is typical)

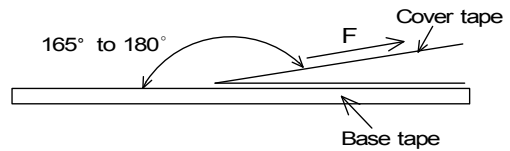

9.5 Dimensions of Leader-tape,Trailer and Reel

There shall be leader-tape (cover tape and empty tape) and trailer-tape (empty tape) as follows.

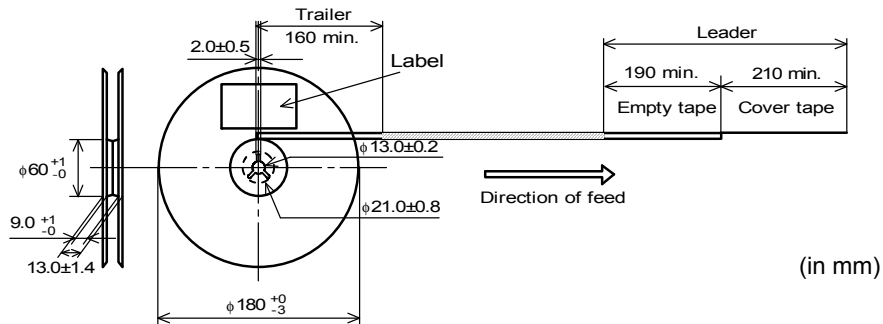

9.6 Marking for reel

Customer part number, MURATA part number, Inspection number(*1) ,RoHS Marking(*2), Quantity etc ...

*1) <Expression of Inspection No.>

□□ 0000 XXX
(1) (2) (3)

- (1) Factory Code
- (2) Date First digit : Year / Last digit of year
 Second digit : Month / Jan. to Sep. → 1 to 9, Oct. to Dec. → O, N, D
 Third, Fourth digit : Day
- (3) Serial No.

*2) <Expression of RoHS Marking >

ROHS - Y (Δ)
(1) (2)

- (1) RoHS regulation conformity parts.
- (2) MURATA classification number

9.7 Marking for Outside package (corrugated paper box)

Customer name, Purchasing order number, Customer part number, MURATA part number, RoHS Marking (*2) ,Quantity, etc ...

9.8. Specification of Outer Case

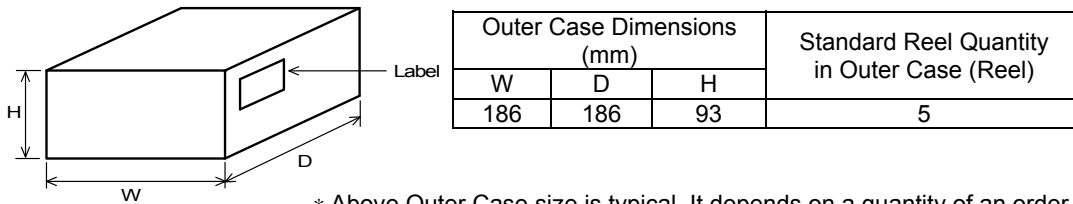

10. ⚠ Caution

Limitation of Applications

Please contact us before using our products for the applications listed below which require especially high reliability for the prevention of defects which might directly cause damage to the third party's life, body or property.

- (1) Aircraft equipment
- (2) Aerospace equipment
- (3) Undersea equipment
- (4) Power plant control equipment
- (5) Medical equipment
- (6) Transportation equipment (vehicles, trains, ships, etc.)
- (7) Traffic signal equipment
- (8) Disaster prevention / crime prevention equipment
- (9) Data-processing equipment
- (10) Applications of similar complexity and /or reliability requirements to the applications listed in the above

11. Notice

Products can only be soldered with reflow.
 This product is designed for solder mounting.
 Please consult us in advance for applying other mounting method such as conductive adhesive.

11.1 Land pattern designing

Recommended land patterns for reflow soldering are as follows:
 These have been designed for Electric characteristics and solderability.
 Please follow the recommended patterns. Otherwise, their performance which includes electrical performance or solderability may be affected, or result to "position shift" in soldering process.

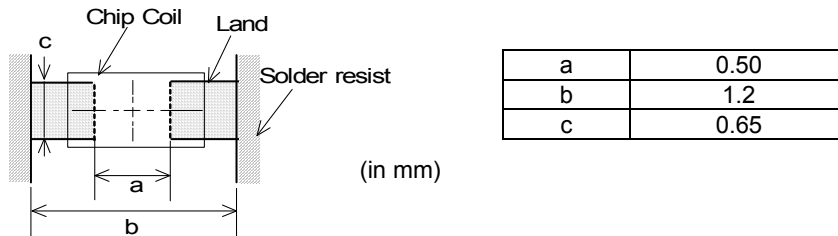

11.2 Flux, Solder

- Use rosin-based flux.
Includes middle activator equivalent to 0.06(wt)% to 0.1(wt) % Chlorine.
Don't use highly acidic flux with halide content exceeding 0.2(wt) % (chlorine conversion value).
Don't use water-soluble flux.
- Use Sn-3.0Ag-0.5Cu solder.
- Standard thickness of solder paste : 100 μ m to 150 μ m.

11.3 Reflow soldering conditions

- Pre-heating should be in such a way that the temperature difference between solder and product surface is limited to 150°C max. Cooling into solvent after soldering also should be in such a way that the temperature difference is limited to 100°C max.
Insufficient pre-heating may cause cracks on the product, resulting in the deterioration of products quality.

- Standard soldering profile and the limit soldering profile is as follows.

The excessive limit soldering conditions may cause leaching of the electrode and / or resulting in the deterioration of product quality.

- Reflow soldering profile

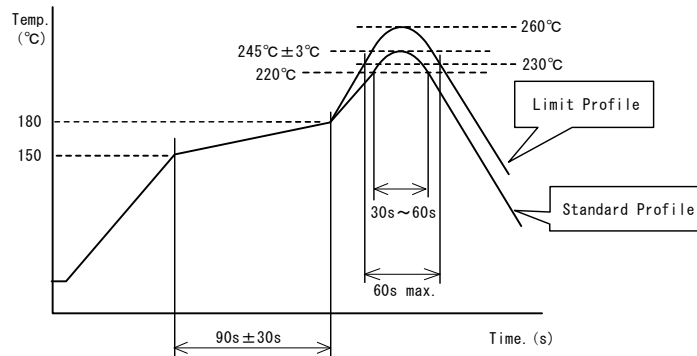

	Standard Profile	Limit Profile
Pre-heating	150°C ~ 180°C , 90s ± 30s	
Heating	above 220°C, 30s ~ 60s	above 230°C, 60s max.
Peak temperature	245°C ± 3°C	260°C, 10s
Cycle of reflow	2 times	2 times

11.4 Reworking with soldering iron

The following conditions must be strictly followed when using a soldering iron.

Pre-heating	150°C, 1 min
Tip temperature	350°C max.
Soldering iron output	80W max.
Tip diameter	φ 3mm max.
Soldering time	3(+1,-0)s
Time	2 times

Note :Do not directly touch the products with the tip of the soldering iron in order to prevent the crack on the products due to the thermal shock.

11.5 Solder Volume

- Solder shall be used not to be exceeded the upper limits as shown below.
- Accordingly increasing the solder volume, the mechanical stress to Chip is also increased.
Exceeding solder volume may cause the failure of mechanical or electrical performance.

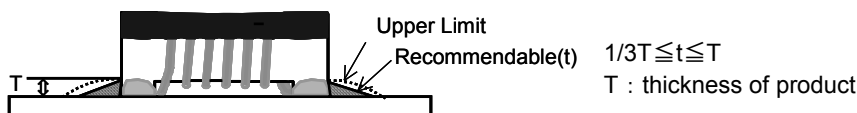

11.6 Product's location

The following shall be considered when designing and laying out P.C.B.'s.

- (1) P.C.B. shall be designed so that products are not subject to the mechanical stress due to warping the board.

[Products direction]

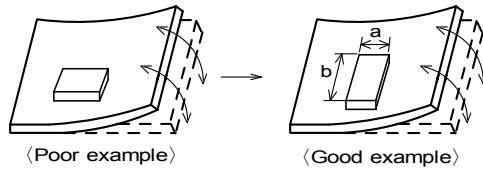

Products shall be located in the sideways direction (Length: $a < b$) to the mechanical stress.

- (2) Components location on P.C.B. separation.

It is effective to implement the following measures, to reduce stress in separating the board.

It is best to implement all of the following three measures; however, implement as many measures as possible to reduce stress.

Contents of Measures	Stress Level
(1) Turn the mounting direction of the component parallel to the board separation surface.	A > D *1
(2) Add slits in the board separation part.	A > B
(3) Keep the mounting position of the component away from the board separation surface.	A > C

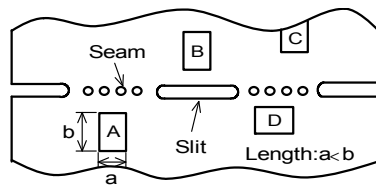

*1 A > D is valid when stress is added vertically to the perforation as with Hand Separation.
If a Cutting Disc is used, stress will be diagonal to the PCB, therefore A > D is invalid.

- (3) Mounting Components Near Screw Holes

When a component is mounted near a screw hole, it may be affected by the board deflection that occurs during the tightening of the screw. Mount the component in a position as far away from the screw holes as possible.

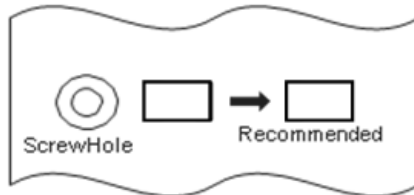

11.7 Cleaning Conditions

Products shall be cleaned on the following conditions.

- (1) Cleaning temperature shall be limited to 60°C max.(40°C max for IPA)
- (2) Ultrasonic cleaning shall comply with the following conditions with avoiding the resonance phenomenon at the mounted products and P.C.B.
Power : 20 W / l max. Frequency : 28kHz to 40kHz Time : 5 min max.
- (3) Cleaner
 1. Alcohol type cleaner
Isopropyl alcohol (IPA)
 2. Aqueous agent
PINE ALPHA ST-100S
- (4) There shall be no residual flux and residual cleaner after cleaning.
In the case of using aqueous agent, products shall be dried completely after rinse with de-ionized water in order to remove the cleaner.
- (5) Other cleaning Please contact us.

11.8 Resin coating

The inductance value may change due to high cure-stress of resin to be used for coating/molding products. An open circuit issue may occur by mechanical stress caused by the resin, amount/cured shape of resin, or operating condition etc. Some resin contains some impurities or chloride possible to generate chlorine by hydrolysis under some operating condition may cause corrosion of wire of coil, leading to open circuit. So, please pay your careful attention when you select resin in case of coating/molding the products with the resin. Prior to use the coating resin, please make sure no reliability issue is observed by evaluating products mounted on your board.

11.9 Caution for use

- Sharp material such as a pair of tweezers or other material such as bristles of cleaning brush , shall not be touched to the winding portion to prevent the breaking of wire.
- Mechanical shock should not be applied to the products mounted on the board to prevent the breaking of the core.

11.10 Notice of product handling at mounting

In some mounting machines,when picking up components support pin pushes up the components from the bottom of base tape. In this case, please remove the support pin. The support pin may damage the components and break wire.

In rare case ,the laser recognition can not recognize this component. Please contact us when you use laser recognition. (There is no problem with the permeation and reflection type.)

11.11 Handling of a substrate

After mounting products on a substrate, do not apply any stress to the product caused by bending or twisting to the substrate when cropping the substrate, inserting and removing a connector from the substrate or tightening screw to the substrate.

Excessive mechanical stress may cause cracking in the product.

Bending

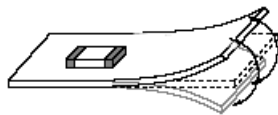

Twisting

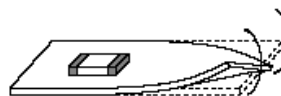

11.12 Storage and Handling Requirements

(1) Storage period

Use the products within 12 months after delivered.

Solderability should be checked if this period is exceeded.

(2) Storage conditions

• Products should be stored in the warehouse on the following conditions.

Temperature : -10°C to 40°C

Humidity : 15% to 85% relative humidity No rapid change on temperature and humidity

• Don't keep products in corrosive gases such as sulfur, chlorine gas or acid, or it may cause oxidization of electrode, resulting in poor solderability.

• Products should not be stored on bulk packaging condition to prevent the chipping of the core and the breaking of winding wire caused by the collision between the products.

• Products should be stored on the palette for the prevention of the influence from humidity, dust and so on.

• Products should be stored in the warehouse without heat shock, vibration, direct sunlight and so on.

(3) Handling Condition

Care should be taken when transporting or handling product to avoid excessive vibration or mechanical shock.

12.  Note

(1) Please make sure that your product has been evaluated in view of your specifications with our product being mounted to your product.

(2) You are requested not to use our product deviating from the reference specifications.

(3) The contents of this reference specification are subject to change without advance notice.

Please approve our product specifications or transact the approval sheet for product specifications before ordering.

<Electrical Performance:Measuring Method of Inductance/Q>

(1) Residual elements and stray elements of test fixture can be described by F-parameter shown in following.

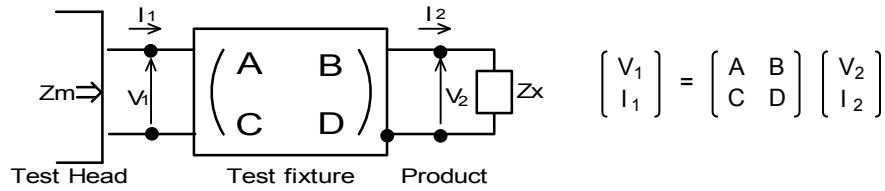

(2) The impedance of chip coil Zx and measured value Zm can be described by input/output current/voltage.

$$Z_m = \frac{V_1}{I_1}, \quad Z_x = \frac{V_2}{I_2}$$

(3) Thus,the relation between Zx and Zm is following;

$$Z_x = \alpha \frac{Z_m - \beta}{1 - Z_m \Gamma} \quad \text{where, } \alpha = D / A = 1$$

$$\beta = B / D = Z_{sm} - (1 - Y_{om} Z_{sm}) Z_{ss}$$

$$\Gamma = C / A = Y_{om}$$

- Zsm : measured impedance of short chip
- Zss : residual impedance of short chip (0.556nH)
- Yom: measured admittance when opening the fixture

(4) Lx and Qx shall be calculated with the following equation.

$$L_x = \frac{\text{Im}(Z_x)}{2\pi f}, \quad Q_x = \frac{\text{Im}(Z_x)}{\text{Re}(Z_x)}$$

Lx : Inductance of chip coil
Qx : Q of chip coil
f : Measuring frequency