

High Power Chip Resistors / Wide Terminal Type

Type: **ERJA1 : 2512**
ERJB1 : 2010
ERJB2 : 1206



■ Features

- High solder-joint reliability by wide terminal construction
- Excellent heat dissipation characteristics by wide terminal construction

■ Recommended Applications

- Automotive electronic circuits including ECUs (Electrical control unit), anti-lock breaking systems and air-bag systems
- Current sensing for power supply circuits in a variety of equipment

■ Explanation of Part Numbers

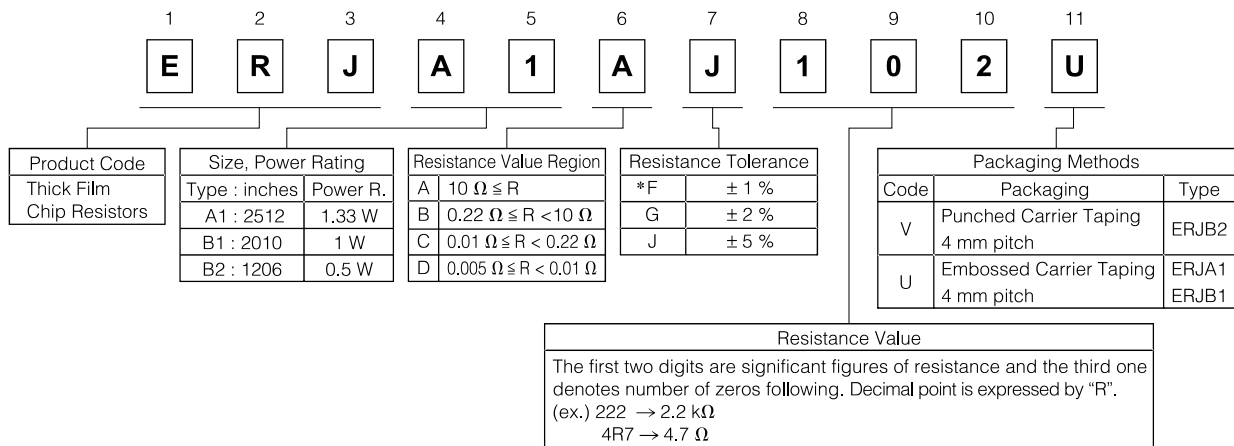

*F : $\pm 1 \%$ more than 100 mΩ (ERJA1)
 $\pm 1 \%$ more than 10 mΩ (ERJB1, ERJB2)

- If the case of Resistance value is lower than 100 mΩ

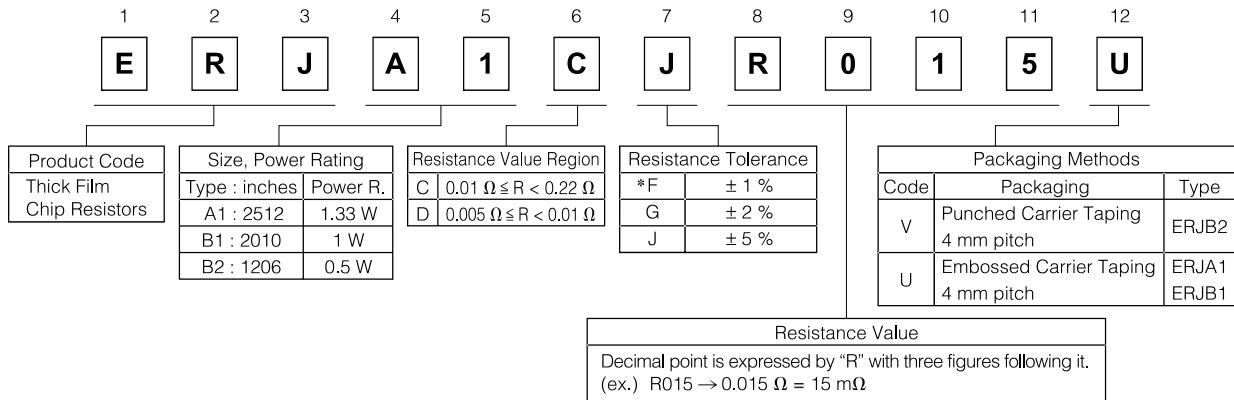

*F : $\pm 1 \%$ more than 100 mΩ (ERJA1)
 $\pm 1 \%$ more than 10 mΩ (ERJB1, ERJB2)

■ Construction (Example : ERJA1 type)

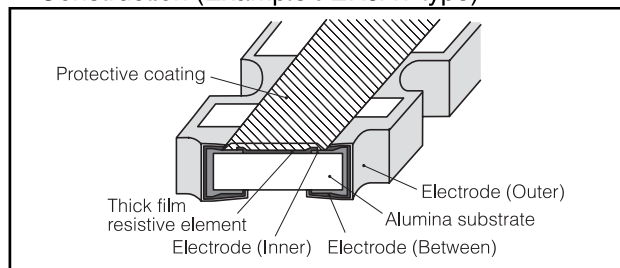

■ Dimensions in mm (not to scale)

ERJA1 type

Dimensions (mm)	L	W	T	A ₁	B ₁
	6.40±0.20	3.20±0.20	0.55±0.10	0.70±0.20	0.45±0.20
Dimensions (mm)	A ₂	B ₂	P	φD	C
	0.70±0.20	1.25±0.15	1.27±0.10	0.30 ^{+0.10} _{-0.20}	0.4 min.

ERJB1 type

Dimensions (mm)	L	W	T	a	b
	5.00±0.20	2.50±0.20	0.55±0.20	0.25±0.20	0.90±0.20

Mass (Weight) [1000 pcs.] : 40 g (ERJA1 type)
 : 27 g (ERJB1 type)
 : 11 g (ERJB2 type)

<Marking Configuration>
 Resistance value is shown by three or four figures.
 The marking is indicated on products with a resistance of 10 ohm higher.

ERJB2 type

(Unit : mm)

	L	W	T	a	b
5 mΩ ≤ R < 10 mΩ	3.20±0.20	1.60±0.15	0.65±0.15	0.30±0.20	0.30±0.20
10 mΩ ≤ R < 220 mΩ				0.20±0.20	0.50±0.20
220 mΩ ≤ R ≤ 1 MΩ					

■ Circuit Configuration

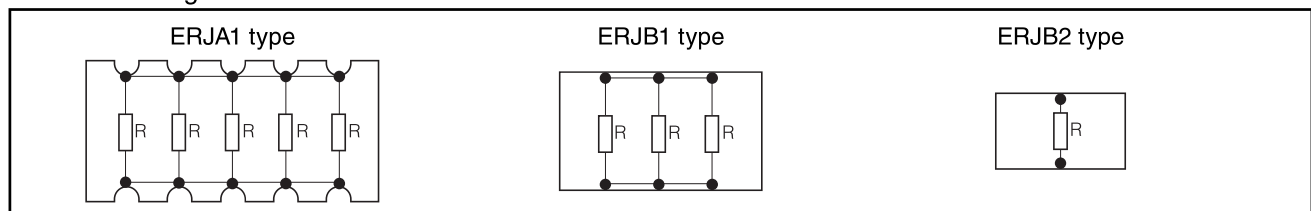

■ Ratings

Type (inches)	ERJA1 (2512)	ERJB1 (2010)	ERJB2 (1206)
Resistance Range (Ω)	10 m to 10 k (E24 series standard)		5 m to 1 M (5 m to 9 m : 1 mΩ step 10 m to 1 M : E24 series standard)
Resistance Tolerance (%)	±1*, ±2, ±5 *±1 % more than 100 mΩ	±1*, ±2, ±5 *±1 % more than 10 mΩ	
Power Rating at 70 °C (W)	1.33	1	0.5
Limiting Element Voltage (Maximum RCWV) ⁽¹⁾ (V)	200		
Maximum Overload Voltage ⁽²⁾ (V)	400		
Temperature Coefficient Resistance (T.C.R.)	R < 22 mΩ	±350	±350
	22 mΩ < R < 47 mΩ		±200
	47 mΩ ≤ R < 100 mΩ		±150
	100 mΩ ≤ R < 1 Ω	0 to +150 (±1 % products) 0 to +200 (±2 %, ±5 % products)	
1 Ω ≤ R	±100 (±1 % products) ±200 (±2 %, ±5 % products)		±100 (±1 % products) ±200 (±2 %, ±5 % products)
Category Temperature Range (Operating Temperature Range) (°C)	-55 to +155		

(1) Rated Continuous Working Voltage (RCWV) shall be determined from $RCWV = \sqrt{\text{Power Rating} \times \text{Resistance Values}}$, or Limiting Element Voltage (max. RCWV) listed above, whichever less.
 (2) Overload (Short-time Overload) Test Voltage (SOTV) shall be determined from $SOTV = 2.5 \times \text{Power Rating}$ or max. Overload Voltage listed above whichever less.

Power Derating Curve

For resistors operated in ambient temperature above 70 °C, power rating shall be derated in accordance with the figure on the right.

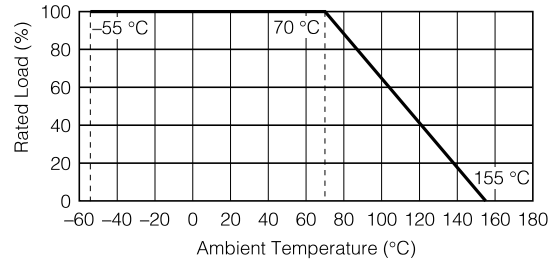

■ Packaging Methods (Taping)

● Standard Quantity

Type (inches)	Kind of Taping	Pitch (P ₁)	Quantity
ERJA1 (2512)	Embossed Carrier Taping	4 mm	4000 pcs./reel
ERJB1 (2010)			5000 pcs./reel
ERJB2 (1206)	Punched Carrier Taping		

● Carrier Tape

(Unit : mm)

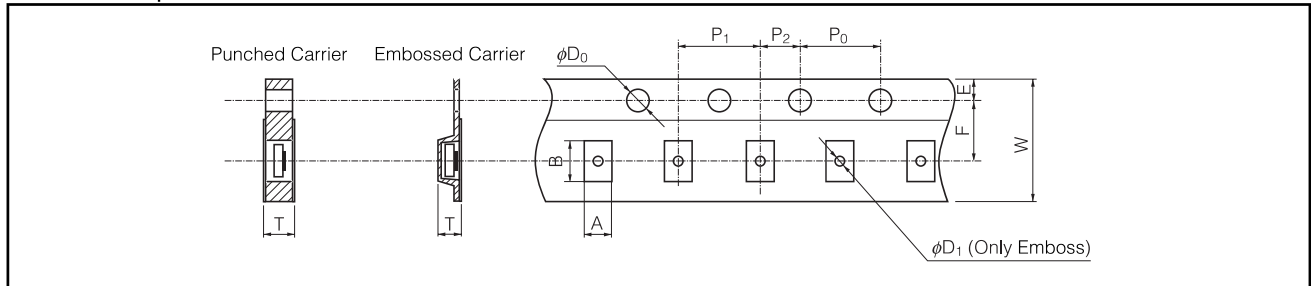

Type	A	B	W	F	E	P ₁	P ₂	P ₀	φD ₀	T	φD ₁
ERJA1	3.50±0.20	6.80±0.20	12.00±0.30	5.50±0.20	1.75±0.20	4.00±0.10	2.00±0.05	4.00±0.10	1.50 ^{+0.10} ₋₀	1.10±0.20	1.50 ^{+0.10} ₋₀
ERJB1	2.80±0.20	5.30±0.20								1.00±0.20	
ERJB2	2.00±0.15	3.60±0.15	8.00±0.15	3.50±0.05	1.75±0.10					0.84±0.10	—

● Taping Reel

(Unit : mm)

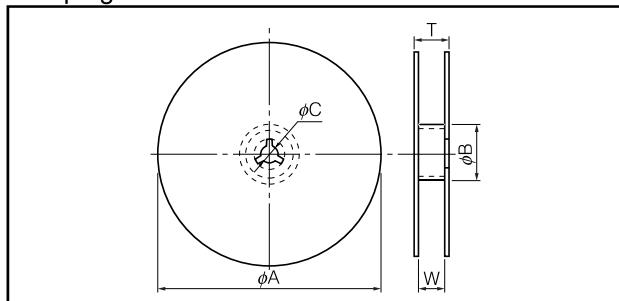

Type	φA	φB	φC	W	T
ERJA1	180.0 ⁺⁰ _{-3.0}	60 min.	13.0±1.0	13.0±0.10	15.4±0.20
ERJB1				9.0±0.10	11.4±0.10
ERJB2					

■ Recommended Land Pattern

● ERJA1 type

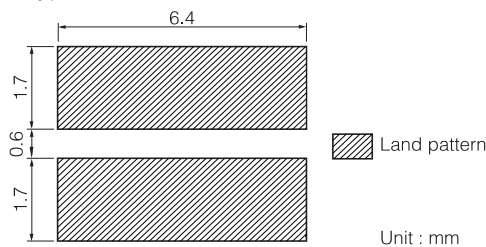

● ERJB1 type

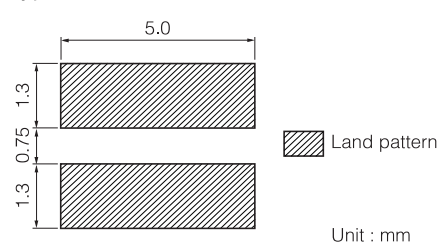

● ERJB2 type

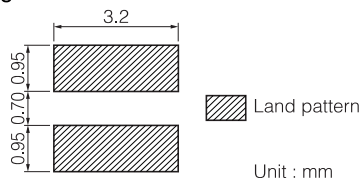

■ Recommended Soldering Conditions

Recommendations and precautions are described below.

- Recommended soldering conditions for reflow
 - Reflow soldering shall be performed a maximum of two times.
 - Please contact us for additional information when used in conditions other than those specified.
 - Please measure the temperature of the terminals and study every kind of solder and printed circuit board for solderability before actual use.

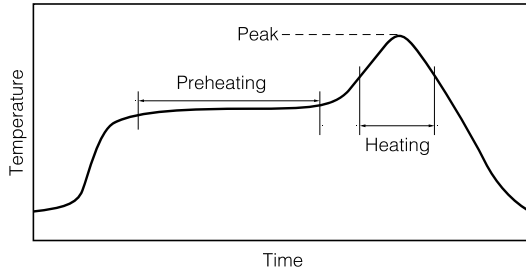

For soldering (Example : Sn/Pb)

	Temperature	Time
Preheating	140 °C to 160 °C	60 s to 120 s
Main heating	Above 200 °C	30 s to 40 s
Peak	235 ± 5 °C	max. 10 s

For lead-free soldering (Example : Sn/Ag/Cu)

	Temperature	Time
Preheating	150 °C to 180 °C	60 s to 120 s
Main heating	Above 230 °C	30 s to 40 s
Peak	max. 260 °C	max. 10 s

● Recommended soldering conditions for flow

	For soldering		For lead-free soldering	
	Temperature	Time	Temperature	Time
Preheating	140 °C to 180 °C	60 s to 120 s	150 °C to 180 °C	60 s to 120 s
Soldering	245 ± 5 °C	20 s to 30 s	max. 260 °C	max. 10 s

⚠ Safety Precautions

The following are precautions for individual products. Please also refer to the precautions common to Fixed Resistors shown on page ER3 of this catalog.

1. Take measures against mechanical stress during and after mounting of High Power Chip Resistors (hereafter called the resistors) so as not to damage their electrodes and protective coatings.
2. If a transient load (heavy load in a short time) like a pulse is expected to be applied, check and evaluate the operations of the resistors when installed in your products before use.
Never exceed the rated power. Otherwise, the performance and/or reliability of the resistors may be impaired.
3. Do not use halogen-based or other high-activity flux. Otherwise, the residue may impair the resistors' performance and/or reliability.
4. When soldering with a soldering iron, never touch the resistors' bodies with the tip of the soldering iron. When using a soldering iron with a high temperature tip, finish soldering as quickly as possible (within three seconds at 350 °C max.).
5. As the amount of applied solder becomes larger, the mechanical stress applied to the resistors increases, causing problems such as cracks and faulty characteristics. Avoid applying an excessive amount of solder.
6. Do not apply shock to the resistors or pinch them with a hard tool (e.g. pliers and tweezers). Otherwise, the resistors' protective coatings and bodies may be chipped, affecting their performance.
7. Avoid excessive bending of printed circuit boards in order to protect the resistors from abnormal stress.

Safety Precautions (Common precautions for Fixed Resistors)

- When using our products, no matter what sort of equipment they might be used for, be sure to make a written agreement on the specifications with us in advance. The design and specifications in this catalog are subject to change without prior notice.
- Do not use the products beyond the specifications described in this catalog.
- This catalog explains the quality and performance of the products as individual components. Before use, check and evaluate their operations when installed in your products.
- Install the following systems for a failsafe design to ensure safety if these products are to be used in equipment where a defect in these products may cause the loss of human life or other significant damage, such as damage to vehicles (automobile, train, vessel), traffic lights, medical equipment, aerospace equipment, electric heating appliances, combustion/gas equipment, rotating equipment, and disaster/crime prevention equipment.
- * Systems equipped with a protection circuit and a protection device
- * Systems equipped with a redundant circuit or other system to prevent an unsafe status in the event of a single fault

(1) Precautions for use

- These products are designed and manufactured for general and standard use in general electronic equipment (e.g. AV equipment, home electric appliances, office equipment, information and communication equipment)
- These products are not intended for use in the following special conditions. Before using the products, carefully check the effects on their quality and performance, and determine whether or not they can be used.
 1. In liquid, such as water, oil, chemicals, or organic solvent
 2. In direct sunlight, outdoors, or in dust
 3. In salty air or air with a high concentration of corrosive gas, such as Cl₂, H₂S, NH₃, SO₂, or NO₂
 4. Electric Static Discharge (ESD) Environment
These components are sensitive to static electricity and can be damaged under static shock (ESD).
Please take measures to avoid any of these environments.
Smaller components are more sensitive to ESD environment.
 5. Electromagnetic Environment
Avoid any environment where strong electromagnetic waves exist.
 6. In an environment where these products cause dew condensation
 7. Sealing or coating of these products or a printed circuit board on which these products are mounted, with resin or other materials
- These products generate Joule heat when energized. Carefully position these products so that their heat will not affect the other components.
- Carefully position these products so that their temperatures will not exceed the category temperature range due to the effects of neighboring heat-generating components. Do not mount or place heat-generating components or inflammables, such as vinyl-coated wires, near these products .
- Note that non-cleaning solder, halogen-based highly active flux, or water-soluble flux may deteriorate the performance or reliability of the products.
- Carefully select a flux cleaning agent for use after soldering. An unsuitable agent may deteriorate the performance or reliability. In particular, when using water or a water-soluble cleaning agent, be careful not to leave water residues. Otherwise, the insulation performance may be deteriorated.

(2) Precautions for storage

The performance of these products, including the solderability, is guaranteed for a year from the date of arrival at your company, provided that they remain packed as they were when delivered and stored at a temperature of 5 °C to 35 °C and a relative humidity of 45 % to 85 %.

Even within the above guarantee periods, do not store these products in the following conditions. Otherwise, their electrical performance and/or solderability may be deteriorated, and the packaging materials (e.g. taping materials) may be deformed or deteriorated, resulting in mounting failures.

1. In salty air or in air with a high concentration of corrosive gas, such as Cl₂, H₂S, NH₃, SO₂, or NO₂
2. In direct sunlight

<Package markings>

Package markings include the product number, quantity, and country of origin. In principle, the country of origin should be indicated in English.