

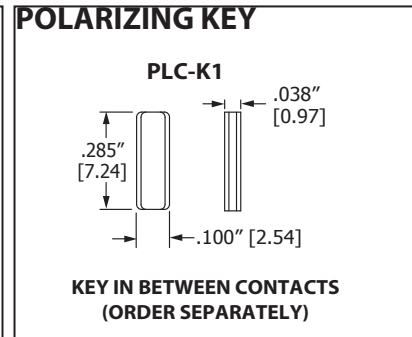

.100" [2.54 mm] Contact Centers, .610" [15.49 mm] Insulator Height, Dip Solder/Wire Wrap/Right Angle/Card Extender

SPECIFICATIONS

- Accommodates .062" ± .008" [1.57 mm ± 0.20 mm] mating PCB (For .093" [2.36 mm] or .125" [3.18 mm] mating PCB see following pages)
- PBT, PPS or PA9T insulator
- Molded-in key available
- 3 Amps current rating for one contact energized
- 30 milli Ohms maximum at rated current
- UL Flammability Rating: 94V-0

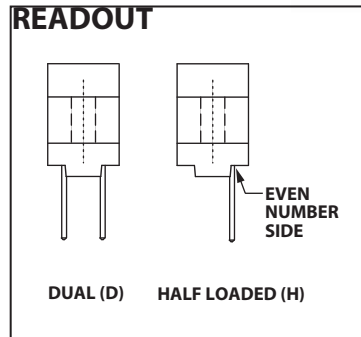
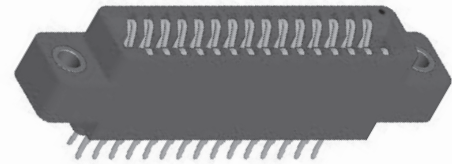

TERMINATION TYPE

HAIRPIN BELLOWS	TERMINATION TYPE	POST CROSS SECTION K	POST LENGTH L .025" [0.64]	FITS MIN. HOLE SIZE
CW	DIP SOLDER	.015" X .025" [0.38 X 0.64]	.125" [3.18]	.035" [0.89]
CT	DIP SOLDER	.015" X .025" [0.38 X 0.64]	.170" [4.32]	.035" [0.89]
CS	DIP SOLDER	.025" [0.64] SQUARE	.160" [4.06]	.040" [1.02]
CM	WIRE WRAP	.025" [0.64] SQUARE	.560" [14.20]	.040" [1.02]
CA	RIGHT ANGLE	.025" [0.64] SQUARE	.100" [2.54]	.043" [1.09]
CB	RIGHT ANGLE	.025" [0.64] SQUARE	.180" [4.57]	.043" [1.09]
CC	RIGHT ANGLE	.025" [0.64] SQUARE	.250" [6.35]	.043" [1.09]

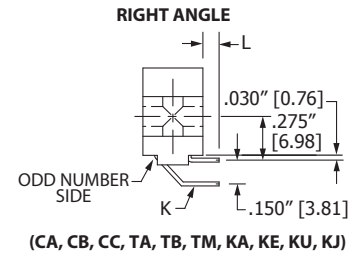
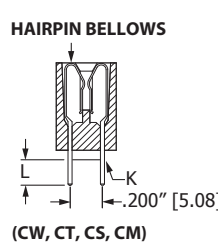

LOOP BELLOWS	TERMINATION TYPE	POST CROSS SECTION K	POST LENGTH L .025" [0.64]	FITS MIN. HOLE SIZE
TK,CK	DIP SOLDER	.025" [0.64] ROUND	.190" [4.83]	.033" [0.84]
RS	DIP SOLDER	.025" [0.64] SQUARE	.190" [4.83]	.040" [1.02]
RM	WIRE WRAP	.025" [0.64] SQUARE	.560" [14.20]	.040" [1.02]
TA	RIGHT ANGLE	.025" [0.64] SQUARE	.100" [2.54]	.043" [1.09]
TB	RIGHT ANGLE	.025" [0.64] SQUARE	.180" [4.57]	.043" [1.09]
TM	RIGHT ANGLE	.025" [0.64] SQUARE	.250" [6.35]	.043" [1.09]

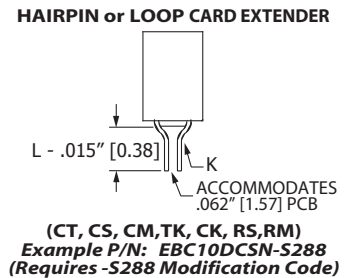
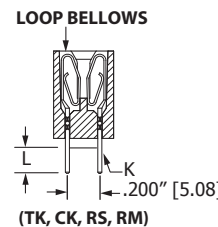

CANTILEVER	TERMINATION TYPE	POST CROSS SECTION K	POST LENGTH L .025" [0.64]	FITS MIN. HOLE SIZE
KS	DIP SOLDER	.025" [0.64] SQUARE	.190" [4.83]	.040" [1.02]
KD	DIP SOLDER	.025" [0.64] SQUARE	.160" [4.06]	.043" [1.09]
KM	WIRE WRAP	.025" [0.64] SQUARE	.560" [14.20]	.040" [1.02]
*KA	RIGHT ANGLE	.025" [0.64] SQUARE	.100" [2.54]	.043" [1.09]
*KE	RIGHT ANGLE	.025" [0.64] SQUARE	.180" [4.57]	.043" [1.09]
*KU	RIGHT ANGLE	.025" [0.64] SQUARE	.250" [6.35]	.043" [1.09]
*KJ	RIGHT ANGLE	.025" [0.64] SQUARE	.500" [12.70]	.043" [1.09]
*KR	CARD EXTENDER	.025" [0.64] SQUARE	.235" [5.97]	N/A
*KN	CARD EXTENDER	.025" [0.64] SQUARE	.605" [15.37]	N/A

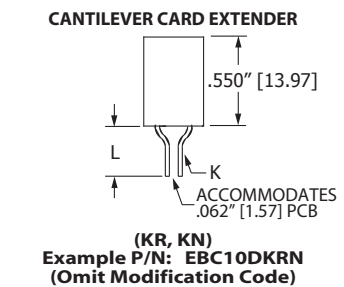
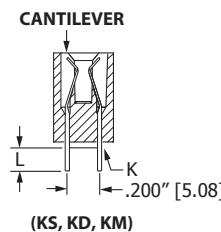

* KA, KE, KU, KJ, KR, KN have no standoffs, unless requested.

MOUNTING STYLE

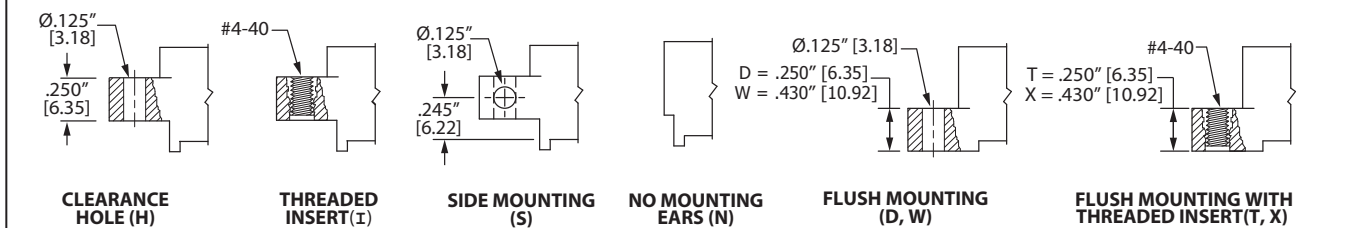



.100" [2.54 mm] Contact Centers, .610" [15.49 mm] Insulator Height, Dip Solder/Wire Wrap/Right Angle/Card Extender

Sullins Female Card Edge

PART NUMBER OPTIONS

MATERIALS (INSULATOR/CONTACT)

- E = PBT/Phosphor Bronze (Standard)
 - R = PPS/Phosphor Bronze
 - G = PA9T/Phosphor Bronze
 - H = PBT/Beryllium Copper
 - A = PPS/Beryllium Copper
 - J = PA9T/Beryllium Copper
- (Consult factory for other materials.)
Refer to Page 7 for Operating/Processing Temperatures

CONTACT FINISH - RoHS Compliant

All platings are Lead Free and have .000050" Nickel underplate

Contact Surface	Termination
B = .000010" Gold	.000100" Pure Tin, Matte
C = .000030" Gold	.000100" Pure Tin, Matte
G = .000010" Gold	.000005" Gold
Y = .000030" Gold	.000005" Gold
Contact Surface	Overall Plating
S = .000010" Gold	.000010" Gold
M = .000030" Gold	.000010" Gold
E = .000100" Pure Tin, Matte	.000100" Pure Tin, Matte

CONTACT CENTERS

- C = .100" [2.54 mm]

NUMBER OF CONTACT POSITIONS

See Chart Below

READOUT (Opposite Page)

- D = Dual
- H = Half Loaded

E B C 70 D CM H - Sxxx

MODIFICATION CODE (Consult Factory)

- OMIT FOR STANDARD
- S189 = .200" [5.08 mm] Row to Row on Right Angle
- S288* = Card Extender Accepts .062" [1.57 mm] PCB
- * Not Required on KR or KN Terminations

MOUNTING STYLE (Opposite Page)

- H = Clearance Holes
- I = Threaded Inserts
- S = Side Mounting
- N = No Mounting
- D,W = Flush Mounting
- T,X = Flush Mounting With Threaded Inserts

TERMINATION TYPE (Opposite Page)

Hairpin Bellows - Available with B or C plating and Phosphor Bronze Only

- CS = .025" [0.64 mm] Square Dip Solder
- CM = .025" [0.64 mm] Square Wire Wrap
- CA, CB, CC = .025" [0.64 mm] Square Right Angle
- CW, CT = .015" X .025" [0.38 mm X 0.64 mm] Dip Solder

Loop Bellows

- RS = .025" [0.64 mm] Square Dip Solder
- CK, TK = .025" [0.64 mm] Round Dip Solder
- RM = .025" [0.64 mm] Square Wire Wrap
- TA, TB, TM = .025" [0.64 mm] Square Right Angle

Cantilever Bellows - Available in Y, B, or C plating Only

- KS, KD = .025" [0.64 mm] Square Dip Solder
- KM = .025" [0.64 mm] Square Wire Wrap
- KA, KE, KU, KJ = .025" [0.64 mm] Square Right Angle
- KR, KN = .025" [0.64 mm] Square Card Extender

DIMENSIONS Dimensions in [] are in millimeters, all others are in inches.

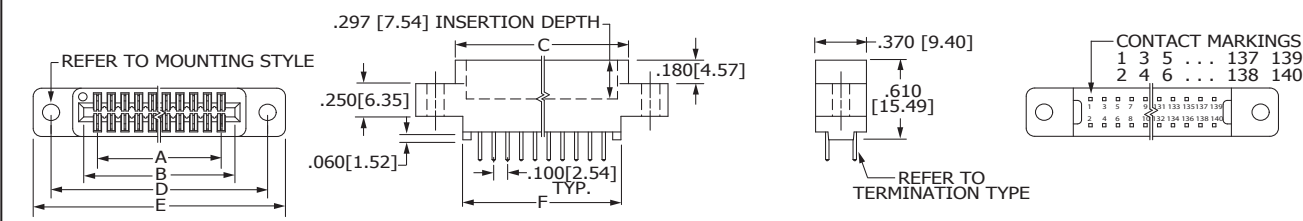

Tolerances on non-critical dimensions may vary slightly due to shrinkage differential per insulator material; Consult factory.

POSITIONS/ CONTACTS	INCHES						MILLIMETERS					
	A±.008	B±.008	C±.015	D±.010	E±.020	F±.015	A±0.20	B±0.20	C±0.38	D±0.25	E±0.51	F±0.38
06/12	0.500	0.700	0.860	1.175	1.435	0.750	12.70	17.78	21.84	29.85	36.45	19.05
07/14	0.600	0.800	0.960	1.275	1.535	0.850	15.24	20.32	24.38	32.39	38.99	21.59
08/16	0.700	0.900	1.060	1.375	1.635	0.950	17.78	22.86	26.92	34.93	41.53	24.13
10/20	0.900	1.100	1.260	1.575	1.835	1.150	22.86	27.94	32.00	40.01	46.61	29.21
12/24	1.100	1.300	1.460	1.775	2.035	1.350	27.94	33.02	37.08	45.09	51.69	34.29
13/26	1.200	1.400	1.560	1.875	2.135	1.450	30.48	35.56	39.62	47.63	54.23	36.83
15/30	1.400	1.600	1.760	2.075	2.335	1.650	35.56	40.64	44.70	52.71	59.31	41.91
17/34	1.600	1.800	1.960	2.275	2.535	1.850	40.64	45.72	49.78	57.79	64.39	46.99
18/36	1.700	1.900	2.060	2.375	2.635	1.950	43.18	48.26	52.32	60.33	66.93	49.53
20/40	1.900	2.100	2.260	2.575	2.835	2.150	48.26	53.34	57.40	65.41	72.01	54.61
22/44	2.100	2.300	2.460	2.775	3.035	2.350	53.34	58.42	62.48	70.49	77.09	59.69
24/48	2.300	2.500	2.660	2.975	3.235	2.550	58.42	63.50	67.56	75.57	82.17	64.77
25/50	2.400	2.600	2.760	3.075	3.335	2.650	60.96	66.04	70.10	78.11	84.71	67.31
28/56	2.700	2.900	3.060	3.375	3.635	2.950	68.58	73.66	77.72	85.73	92.33	74.93
30/60	2.900	3.100	3.260	3.575	3.835	3.150	73.66	78.74	82.80	90.81	97.41	80.01
31/62	3.000	3.200	3.360	3.675	3.935	3.250	76.20	81.28	85.34	93.35	99.95	82.55
35/70	3.400	3.600	3.760	4.075	4.335	3.650	86.36	91.44	95.50	103.51	110.11	92.71
36/72	3.500	3.700	3.860	4.175	4.435	3.750	88.90	93.98	98.04	106.05	112.65	95.25
40/80	3.900	4.100	4.260	4.575	4.835	4.150	99.06	104.14	108.20	116.21	122.81	105.41
43/86	4.200	4.400	4.560	4.875	5.135	4.450	106.68	111.76	115.82	123.83	130.43	113.03
44/88	4.300	4.500	4.660	4.975	5.235	4.550	109.22	114.30	118.36	126.37	132.97	115.57
49/98*	4.800	5.000	5.160	5.475	5.735	5.050	121.92	127.00	131.06	139.07	145.67	128.27
50/100	4.900	5.100	5.260	5.575	5.835	5.150	124.46	129.54	133.60	141.61	148.21	130.81
55/110	5.400	5.600	5.760	6.075	6.335	5.650	137.16	142.24	146.30	154.31	160.91	143.51
60/120	5.900	6.100	6.260	6.575	6.835	6.150	149.86	154.94	159.00	167.01	173.61	156.21
61/122	6.000	6.200	6.360	6.675	6.935	6.250	152.40	157.48	161.54	169.55	176.15	158.75
65/130	6.400	6.600	6.760	7.075	7.335	6.650	162.56	167.64	171.70	179.71	186.31	168.91
70/140	6.900	7.100	7.260	7.575	7.835	7.150	175.26	180.34	184.40	192.41	199.01	181.61
80/160*	7.900	8.100	8.260	8.575	8.835	8.150	200.66	205.74	209.80	217.81	224.41	207.01
90/180*	8.900	9.100	9.260	9.575	9.835	9.150	226.06	231.14	235.20	243.21	249.81	232.41
100/200*	9.900	10.100	10.260	10.575	10.835	10.150	251.46	256.54	260.60	268.61	275.21	257.81

* Consult factory for availability.