

SURFACE MOUNT GPP
GPP TRANSIENT VOLTAGE SUPPRESSOR
400 WATT PEAK POWER 1.0 WATT STEADY STATE

FEATURES

- * Plastic package has underwriters laboratory
- * Glass passivated chip construction
- * 400 watt surage capability at 1ms
- * Excellent clamping capability
- * Low zener impedance
- * Fast response time

MECHANICAL DATA

* UL listed the recognized component directory (QVGQ2), file #E211196

Ratings at 25 °C ambient temperature unless otherwise specified.

MAXIMUM RATINGS AND ELECTRICAL CHARACTERISTICS

Ratings at 25 °C ambient temperature unless otherwise specified.



DO-214AC

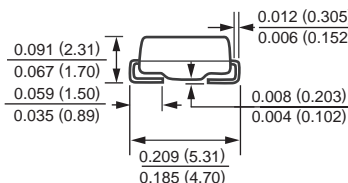
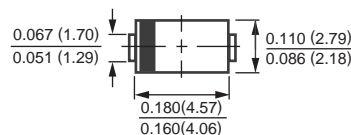

Dimensions in inches and (millimeters)

DEVICES FOR BIPOLAR APPLICATIONS

For Bidirectional use C or CA suffix for types TFMAJ5.0 thru TFMAJ170

Electrical characteristics apply in both direction

MAXIMUM RATINGS (At TA = 25°C unless otherwise noted)

RATINGS	SYMBOL	VALUE	UNITS
Peak Power Dissipation with a 10/1000uS (Note 1,2,5 Fig.1)	PPPM	Minimum 400	Watts
Peak Pulse Current with a 10/1000uS waveform (Note 1, Fig.2)	IPPM	SEE TABLE 1	Amps
Steady State Power Dissipation (Note 3)	PM(AV)	1.0	Watts
Peak Forward Surge Current per Fig.5 (Note 3)	IFSM	40	Amps
Maximum Instantaneous Forward Voltage at 25A (Note 4)	VF	3.5	Volts
Operating and Storage Temperature Range	TJ, TSTG	-55 to + 150	°C

- NOTES :
1. Non-repetitive current pulse, per Fig.3 and derated above TA = 25°C per Fig.2.
 2. Mounted on 0.2 X 0.2" (5.0 X 5.0mm) copper pad to each terminal.
 3. Lead temperature at TL = 25°C
 4. Measured on 8.3mS single half sine-wave duty cycle = 4 pules per minute maximum.
 5. Peak pulse power waveform is 10/1000uS.

RATING AND CHARACTERISTIC CURVES (TFMAJ5.0 THRU TFMAJ170CA)

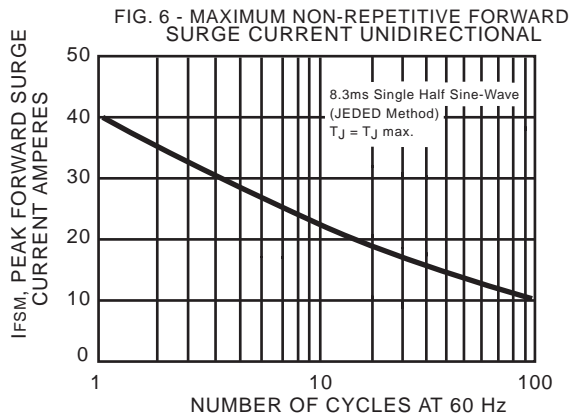
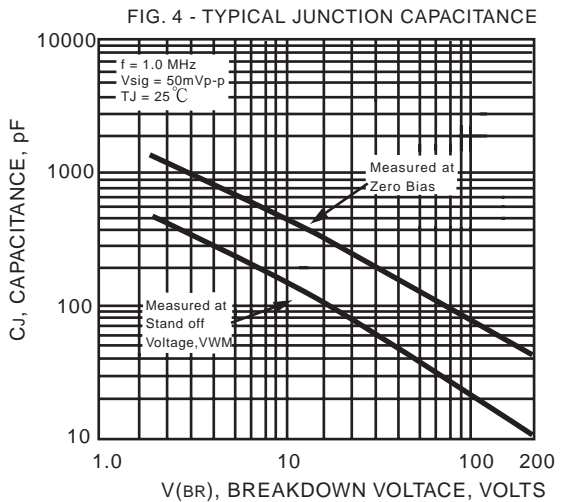
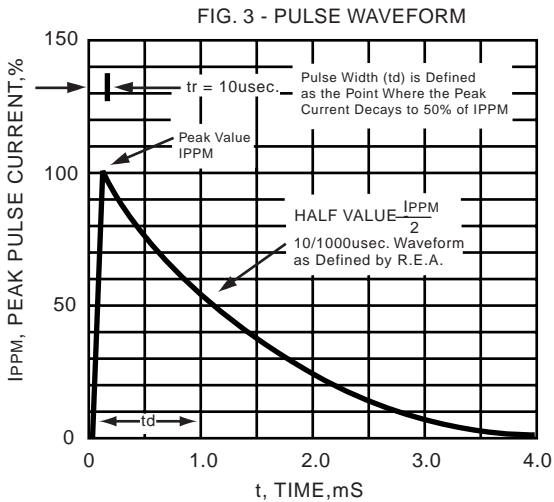
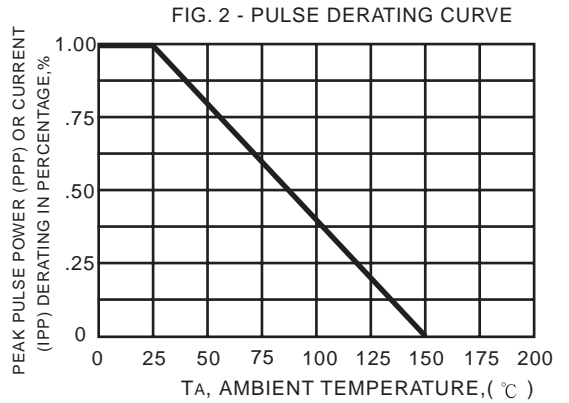
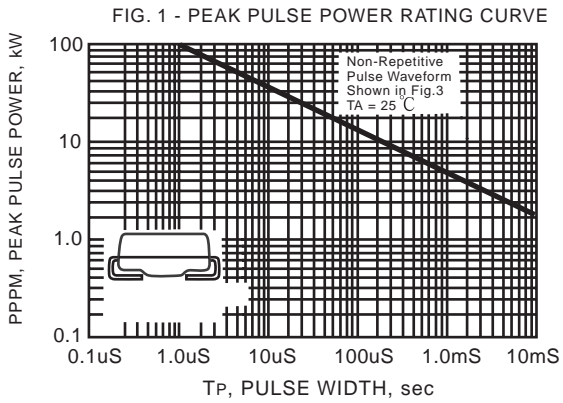

TRANSIENT VOLTAGE SUPPRESSORS

400W SERIES TVS DIODES/DO-214AC (CASE 2) 400W

Rectron Industry No.	Rectron House No.	Breakdown Voltage			Reverse Stand off Voltage VWM (Volts)	Maximum Reverse Leakage at VWM ID(uA)	Maximum Peak Pulse Current IPPM (Amps)	Maximum Clamping Voltage at IPPM VC (Volts)
		VBR (Volts)		@IT (mA)				
		MIN.	MAX.					
SMAJ5.0	TFMAJ5.0	6.40	7.82	10	5.0	800.0	41.7	9.6
SMAJ5.0A	TFMAJ5.0A	6.40	7.07	10	5.0	800.0	43.5	9.2
SMAJ6.0	TFMAJ6.0	6.67	8.15	10	6.0	800.0	35.1	11.4
SMAJ6.0A	TFMAJ6.0A	6.67	7.37	10	6.0	800.0	38.8	10.3
SMAJ6.5	TFMAJ6.5	7.22	8.82	10	6.5	500.0	32.5	12.3
SMAJ6.5A	TFMAJ6.5A	7.22	7.98	10	6.5	500.0	35.7	11.2
SMAJ7.0	TFMAJ7.0	7.78	9.51	10	7.0	200.0	30.1	13.3
SMAJ7.0A	TFMAJ7.0A	7.78	8.60	10	7.0	200.0	33.3	12.0
SMAJ7.5	TFMAJ7.5	8.33	10.2	1.0	7.5	100.0	28.0	14.3
SMAJ7.5A	TFMAJ7.5A	8.33	9.21	1.0	7.5	100.0	31.0	12.9
SMAJ8.0	TFMAJ8.0	8.89	10.9	1.0	8.0	50.0	26.7	15.0
SMAJ8.0A	TFMAJ8.0A	8.89	9.83	1.0	8.0	50.0	29.4	13.6
SMAJ8.5	TFMAJ8.5	9.44	11.5	1.0	8.5	10.0	25.2	15.9
SMAJ8.5A	TFMAJ8.5A	9.44	10.4	1.0	8.5	10.0	27.8	14.4
SMAJ9.0	TFMAJ9.0	10.0	12.2	1.0	9.0	5.0	23.7	16.9
SMAJ9.0A	TFMAJ9.0A	10.0	11.1	1.0	9.0	5.0	26.0	15.4
SMAJ10	TFMAJ10	11.1	13.6	1.0	10.0	5.0	21.3	18.8
SMAJ10A	TFMAJ10A	11.1	12.3	1.0	10.0	5.0	23.5	17.0
SMAJ11	TFMAJ11	12.2	14.9	1.0	11.0	5.0	19.9	20.1
SMAJ11A	TFMAJ11A	12.2	13.5	1.0	11.0	5.0	22.0	18.2
SMAJ12	TFMAJ12	13.3	16.3	1.0	12.0	5.0	18.2	22.0
SMAJ12A	TFMAJ12A	13.3	14.7	1.0	12.0	5.0	20.1	19.9
SMAJ13	TFMAJ13	14.4	17.6	1.0	13.0	5.0	16.8	23.8
SMAJ13A	TFMAJ13A	14.4	15.9	1.0	13.0	5.0	18.6	21.5
SMAJ14	TFMAJ14	15.6	19.1	1.0	14.0	5.0	15.5	25.8
SMAJ14A	TFMAJ14A	15.6	17.2	1.0	14.0	5.0	17.2	23.2
SMAJ15	TFMAJ15	16.7	20.4	1.0	15.0	5.0	14.9	26.9
SMAJ15A	TFMAJ15A	16.7	18.5	1.0	15.0	5.0	16.4	24.4
SMAJ16	TFMAJ16	17.8	21.8	1.0	16.0	5.0	13.9	28.8
SMAJ16A	TFMAJ16A	17.8	19.7	1.0	16.0	5.0	15.4	26.0
SMAJ17	TFMAJ17	18.9	23.1	1.0	17.0	5.0	13.1	30.5
SMAJ17A	TFMAJ17A	18.9	20.9	1.0	17.0	5.0	14.5	27.6
SMAJ18	TFMAJ18	20.0	24.4	1.0	18.0	5.0	12.4	32.2
SMAJ18A	TFMAJ18A	20.0	22.1	1.0	18.0	5.0	13.7	29.2
SMAJ20	TFMAJ20	22.2	27.1	1.0	20.0	5.0	11.2	35.8
SMAJ20A	TFMAJ20A	22.2	24.5	1.0	20.0	5.0	12.3	32.4
SMAJ22	TFMAJ22	24.4	29.8	1.0	22.0	5.0	10.2	39.4
SMAJ22A	TFMAJ22A	24.4	26.9	1.0	22.0	5.0	11.3	35.5
SMAJ24	TFMAJ24	26.7	32.6	1.0	24.0	5.0	9.3	43.0
SMAJ24A	TFMAJ24A	26.7	29.5	1.0	24.0	5.0	10.3	38.9
SMAJ26	TFMAJ26	28.9	35.3	1.0	26.0	5.0	8.6	46.6
SMAJ26A	TFMAJ26A	28.9	31.9	1.0	26.0	5.0	9.5	42.1
SMAJ28	TFMAJ28	31.1	38.0	1.0	28.0	5.0	8.0	50.0
SMAJ28A	TFMAJ28A	31.1	34.4	1.0	28.0	5.0	8.8	45.4
SMAJ30	TFMAJ30	33.3	40.7	1.0	30.0	5.0	7.5	53.5
SMAJ30A	TFMAJ30A	33.3	36.8	1.0	30.0	5.0	8.3	48.4
SMAJ33	TFMAJ33	36.7	44.9	1.0	33.0	5.0	6.8	59.0
SMAJ33A	TFMAJ33A	36.7	40.6	1.0	33.0	5.0	7.5	53.3
SMAJ36	TFMAJ36	40.0	48.9	1.0	36.0	5.0	6.2	64.3
SMAJ36A	TFMAJ36A	40.0	44.2	1.0	36.0	5.0	6.9	58.1

TRANSIENT VOLTAGE SUPPRESSORS

400W SERIES TVS DIODES/DO-214AC (CASE 2) 400W

Rectron Industry No.	Rectron House No.	Breakdown Voltage			Reverse Stand off Voltage V _{WM} (Volts)	Maximum Reverse Leakage at V _{WM} I _D (uA)	Maximum Peak Pulse Current IPPM (Amps)	Maximum Clamping Voltage at IPPM V _C (Volts)
		V _{BR} (Volts)		@IT (mA)				
		MIN.	MAX.					
SMAJ40	TFMAJ40	44.4	54.3	1.0	40	5.0	5.6	71.4
SMAJ40A	TFMAJ40A	44.4	49.1	1.0	40	5.0	6.2	64.5
SMAJ43	TFMAJ43	47.8	58.4	1.0	43	5.0	5.2	76.7
SMAJ43A	TFMAJ43A	47.8	52.8	1.0	43	5.0	5.8	69.4
SMAJ45	TFMAJ45	50.0	61.1	1.0	45	5.0	5.0	80.3
SMAJ45A	TFMAJ45A	50.0	55.3	1.0	45	5.0	5.5	72.7
SMAJ48	TFMAJ48	53.3	65.1	1.0	48	5.0	4.7	85.5
SMAJ48A	TFMAJ48A	53.3	58.9	1.0	48	5.0	5.2	77.4
SMAJ51	TFMAJ51	56.7	69.3	1.0	51	5.0	4.4	91.1
SMAJ51A	TFMAJ51A	56.7	62.7	1.0	51	5.0	4.9	82.4
SMAJ54	TFMAJ54	60.0	73.3	1.0	54	5.0	4.2	96.3
SMAJ54A	TFMAJ54A	60.0	66.3	1.0	54	5.0	4.6	87.1
SMAJ58	TFMAJ58	64.4	78.7	1.0	58	5.0	3.9	103
SMAJ58A	TFMAJ58A	64.4	71.2	1.0	58	5.0	4.3	93.6
SMAJ60	TFMAJ60	66.7	81.5	1.0	60	5.0	3.7	107
SMAJ60A	TFMAJ60A	66.7	73.7	1.0	60	5.0	4.1	96.8
SMAJ64	TFMAJ64	71.1	86.9	1.0	64	5.0	3.5	114
SMAJ64A	TFMAJ64A	71.1	78.6	1.0	64	5.0	3.9	103
SMAJ70	TFMAJ70	77.8	95.1	1.0	70	5.0	3.2	125
SMAJ70A	TFMAJ70A	77.8	86.0	1.0	70	5.0	3.5	113
SMAJ75	TFMAJ75	83.3	102	1.0	75	5.0	3.0	134
SMAJ75A	TFMAJ75A	83.3	92.1	1.0	75	5.0	3.3	121
SMAJ78	TFMAJ78	86.7	106	1.0	78	5.0	2.9	139
SMAJ78A	TFMAJ78A	86.7	95.8	1.0	78	5.0	3.2	126
SMAJ85	TFMAJ85	94.4	115	1.0	85	5.0	2.0	151
SMAJ85A	TFMAJ85A	94.4	104	1.0	85	5.0	2.2	137
SMAJ90	TFMAJ90	100	122	1.0	90	5.0	1.9	160
SMAJ90A	TFMAJ90A	100	111	1.0	90	5.0	2.1	146
SMAJ100	TFMAJ100	111	136	1.0	100	5.0	1.7	179
SMAJ100A	TFMAJ100A	111	123	1.0	100	5.0	1.9	162
SMAJ110	TFMAJ110	122	149	1.0	110	5.0	1.5	196
SMAJ110A	TFMAJ110A	122	135	1.0	110	5.0	1.7	177
SMAJ120	TFMAJ120	133	163	1.0	120	5.0	1.4	214
SMAJ120A	TFMAJ120A	133	147	1.0	120	5.0	1.6	193
SMAJ130	TFMAJ130	144	176	1.0	130	5.0	1.3	231
SMAJ130A	TFMAJ130A	144	159	1.0	130	5.0	1.4	209
SMAJ150	TFMAJ150	167	204	1.0	150	5.0	1.1	268
SMAJ150A	TFMAJ150A	167	185	1.0	150	5.0	1.2	243
SMAJ160	TFMAJ160	178	218	1.0	160	5.0	1.0	287
SMAJ160A	TFMAJ160A	178	197	1.0	160	5.0	1.2	259
SMAJ170	TFMAJ170	189	231	1.0	170	5.0	0.99	304
SMAJ170A	TFMAJ170A	189	209	1.0	170	5.0	1.09	275

- Notes :
1. V_{BR} measured after I_T applied for 300ms. I_T = square pulse or equivalent.
 2. For bidirectional use C or CA suffixs for all types (ex. SMAJ5.0C,SMAJ170CA) electrical characteristics apply in both directions.
 3. For bidirectional types having V_{WM} of 10 volts and less, the I_D limit is doubled.

Mounting Pad Layout

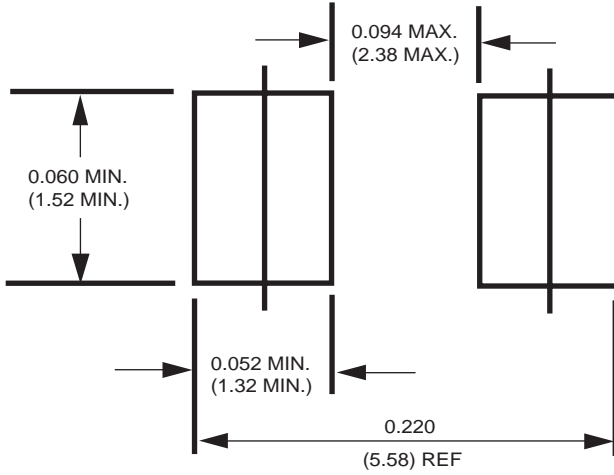

Dimensions in inches and (millimeters)