



RJ Series Slim Power Relays

Key features:

- Compact and rugged power relays. Large switching capacity
- Compact housing only 12.7-mm wide.
Large contact rating
RJ1 (1-pole): 16A (UL general use rating @250V AC)
RJ2 (2-pole): 8A
- Non-polarized LED indicator available on blade type. IDEC's unique light guide structure enables high visibility of coil status from any direction.
- The smallest width for 2-pole/bifurcated contact relay
- Excellent electrical and mechanical life.
Electrical life: 200,000 operations (AC load)
Mechanical life: 30 million operations (AC coil)
- RoHS directive compliant (EU directive 2002/95/EC). Contains no lead, cadmium, mercury, hexavalent chromium, PBB or PBDE.
- Diode model:
Diode reverse withstand voltage: 1000V
- UL recognized, CSA certified, EN compliant.



Part Number Selection

Style	Terminal	Contact	Model	Part Number	Coil Voltage Code (Standard Stock in bold)
	Blade	SPDT	Standard	RJ1S-C-□	A24 , A110, A120 , A220, A240 , D12, D24 , D48, D100
			with LED	RJ1S-CL-□	
			with Surge Suppression Diode	RJ1S-CD-□	D12, D24 , D48, D100
			with LED & Surge Suppression Diode	RJ1S-CLD-□	
		DPDT	Standard	RJ2S-C-□	A24 , A110, A120 , A220, A240 , D12, D24 , D48, D100
			with LED	RJ2S-CL-□	
			with Surge Suppression Diode	RJ2S-CD-□	D12, D24 , D48, D100
			with LED & Surge Suppression Diode	RJ2S-CLD-□	
			Standard Bifurcated contacts (without LED indicator)	RJ22S-C-□	A12, A24 , A120 , A240 , D5, D12, D24 , D100
			Bifurcated contacts diode (without LED indicator)	RJ22S-CL-□	
	PCB	SPDT	Standard	RJ1V-C-□	
			High Capacity	RJ1V-CH-□	
		SPST-NO	Standard	RJ1V-A-□	A24 , A110, A120 , A220, A240 , D5, D6, D12, D24 , D48, D100
			High Capacity	RJ1V-AH-□	
		DPDT	Standard	RJ2V-C-□	
		DPST-NO	Standard	RJ2V-A-□	
		DPDT	Bifurcated contacts	RJ22V-C-□	A12, A24 , A120 , A240 , D5, D12, D24 , D48, D100
		DPST-NO	Bifurcated contacts	RJ22V-A-□	

Ordering Information

When ordering, specify the Part No. and coil voltage code:

(example) RJ1S-C- A120
Part No. Coil Voltage Code

Coil Voltage Table

Coil Voltage Code	A12	A24	A110	A120	A220	A240	D5	D6	D12	D24	D48	D100
Coil Rating	12V AC	24V AC	110V AC	120V AC	220V AC	240V AC	5V DC	6V DC	12V DC	24V DC	48V DC	100-110V DCV DC

Sockets

	Relays	Standard DIN Rail Mount	Finger-safe DIN Rail Mount	PCB Mount
Blade Models	RJ1S (Std)	SJ1S-05BW	SJ1S-07LW	SJ1S-61
	RJ2S (Std)/RJ22S	SJ2S-05BW	SJ2S-07LW	SJ2S-61
PCB Models	RJ1V (Std)	—	SQ1V-07B*	SQ1V-63*
	RJ1V (HC) RJ2V/RJ22V	—	SQ2V-07B*	SQ2V-63*



Shown with optional marking plate.



Replacement Hold Down Springs

Part Number	Used With Socket
SJ9Z-CM	SJ1S-05BW, SJ1S-07LW, SJ2S-05BW, SJ2S-07LW
SQ9Z-C	SQ1V-07B, SQ2V-07B
SQ9Z-C63	SQ1V-63, SQ2V-63

Jumpers for SJ Sockets

Poles	Part Number	Quantity
2	SJ9Z-JF2	Must purchase in quantities of 10.
5	SJ9Z-JF5	
8	SJ9Z-JF8	
10	SJ9Z-JF10	



*Hold-down clip or spring must be removed to use with RJ PCB relays.

Accessories

Item	Appearance	Use with	Part No.	Remarks
Aluminum DIN Rail (1 meter length)		All DIN rail sockets	BNDN1000	The BNDN1000 is designed to accommodate DIN mount sockets. Made of durable extruded aluminum, the BNDN1000 measures 0.413 (10.5mm) in height and 1.37 (35mm) in width (DIN standard). Standard length is 39" (1,000mm).
DIN Rail End Stop		DIN rail	BNL5	9.1 mm wide.
Marking Plate		Finger safe sockets (ONLY)	SJ9Z-PWPN10	10 pieces per pack

Specifications

Model		RJ1	RJ2	RJ22S	RJ22V
Number of Poles		1-pole		2-pole	
Contact Configuration		SPDT	DPDT	DPDT bifurcated contacts	DPDT (bifurcated), DPST-NO (bifurcated)
Contact Material		Silver-nickel alloy		AgNi (gold clad)	
Degree of Protection		IP40			Flux-tight structure
Contact Resistance (initial value) ¹		50 mΩ maximum			
Operating Time ²		15ms maximum (with diode: 20 ms maximum)			
Release Time ²		10 ms maximum (with diode: 20 ms maximum)			
Dielectric Strength	Between contact and coil	5000V AC, 1 minute			
	Between contacts of the same pole	1000V AC, 1 minute			
	Between contacts of different poles	—	3000V AC, 1 minute		
Vibration Resistance	Operating extremes	10 to 55 Hz, amplitude 0.75 mm			
	Damage limits	10 to 55 Hz, amplitude 0.75 mm			
Shock Resistance	Operating extremes	NO contact: 200 m/s ² , NC contact: 100 m/s ²			
	Damage limits	1000 m/s ²			
Electrical Life (rated load)		AC load: 200,000 operations minimum (operation frequency 1800 operations per hour) DC load: 100,000 operations minimum (operation frequency 1800 operations per hour)		AC load: 100,000 operations minimum (operation frequency 1,800 per hour) DC load: 200,000 operations minimum (operation frequency 1,800 per hour)	
Mechanical Life (no load)		AC coil: 30,000,000 operations minimum (operation frequency 18,000 operations per hour) DC coil: 50,000,000 operations minimum (operation frequency 18,000 operations per hour)		AC load: 10 million operations minimum (operating frequency 18,000 operations per hour) DC load: 20 million operations minimum (operating frequency 18,000 operations per hour)	
Operating Temperature ³		-40 to +70°C (no freezing)			
Operating Humidity		5 to 85% RH (no condensation)			
Weight (approx.)		19g (blade type), 17g (PCB form C type), 16g (PCB form A type)		19g	DPDT: 17g, DPST-NO: 16g



Note: Above values are initial values.

1. Measured using 5V DC, 1A voltage drop method.
2. Measured at the rated voltage (at 20°C), excluding contact bounce time.
3. 100% rated voltage.

Switches & Pilot Lights

Signaling Lights

Relays & Sockets

Timers

Contactors

Terminal Blocks

Circuit Breakers

Switches & Pilot Lights

Signaling Lights

Relays & Sockets

Timers

Coil Ratings

	Rated Voltage		Coil Voltage Code	Rated Current (mA) ±15% (at 20°C)				Coil Resistance (ohms)±10% (at 20°C)	Operating Characteristics ²			Power Consumption	
				Without LED ¹		With LED ¹			Pickup Voltage	Dropout Voltage	Maximum Allowable Voltage ³		
				50Hz	60Hz	50Hz	60Hz						
AC	Blade & PCB Models	24V	A24	43.9	37.5	47.5	41.1	243	80% max	30% min	140%	0.9VA (60Hz)	
		120V	A120	8.8	7.5	8.7	7.4	6,400					
		240V	A240	4.3	3.7	4.3	3.7	25,570					
	Bifurcated Models	12V	A12	87.3	75.0	91.1	78.8	62.5					
		24V	A24	43.9	37.5	47.5	41.1	243					
		120V	A120	8.8	7.5	8.7	7.4	6,400					
		240V	A240	4.3	3.7	4.3	3.7	25,570				Approx. 1.1VA (50Hz) 0.9 to 1.2VA (60Hz)	
DC	Rated Voltage		Coil Voltage Code	Rated Current (mA) ±15% (at 20°C)				Coil Resistance (ohms)±10% (at 20°C)	Operating Characteristics ²			Power Consumption	
				Without LED ¹		With LED ¹			Pickup Voltage	Dropout Voltage	Maximum Allowable Voltage ³		
	Blade Models	12V		D12	44.2		48.0					271	70% max
		24V		D24	22.1		25.7		1,080				
		48V		D48	11.0		10.7		4,340				
		100-110V		D100	5.3 - 5.8		5.2 - 5.7		18,870				
	PCB Models	5V		D5	106		-		47.2	70% max	10% min	170%	0.53-0.64W
		6V		D6	88.3		-		67.9				
		12V		D12	44.2		-		271				
		24V		D24	22.1		-		1,080				
	Bifurcated Models	48V		D48	11.0		-		4,340	70% max	10% min	170%	0.53-0.64W
		100-110V		D100	5.3 - 5.8		-		18,870				
		5V		D5	106		110		47.2				
		12V		D12	44.2		48.0		271				
			24V	D24	22.1		25.7		1,080				Approx. 0.53 to 0.64W
			48V	D48	11		10.7		4,340				
			100-110V	D100	5.3-5.8		5.2-5.7		18,870				

1. LED Indicator is only available on Blade or Bifurcated relays.
2. Operating characteristics are at 20°C.
3. The maximum allowable voltage is the maximum value which can be applied to the relay coils.

Contact Ratings

	Model	Contact	Allowable Contact Power		Rated Load			Allowable Switching Current	Allowable Switching Voltage	Minimum Applicable Load	
			Resistive Load	Inductive Load	Voltage	Resistive Load	Inductive Load cosφ=0.3 L/R=7ms				
Blade Models	1 pole	NO	3000V AC	1875VA	250V AC	12A	7.5A	16A	AC250V	DC5V	
		NC	3000V AC	1875VA	250V AC	12A	7.5A	6A	DC30V	100mA	
	2 poles	NO	2000V AC	1000VA	250V AC	8A	4A	4A	AC250V	DC5V	
		NC	2000V AC	1000VA	250V AC	8A	4A	4A	DC30V	10mA	
PCB Models	2 poles (bifurcated contacts)	NO	250VA AC	100VA AC	250V AC	1A	0.4A	1A	250V AC	1V DC	
		NC	30W DC	15W DC	30V DC	1A	0.5A				125V DC
	1 pole	Standard Type	NO	3000V AC	1875VA	250V AC	12A	7.5A	12A	AC250V	DC5V
			NC	3000V AC	1875VA	250V AC	12A	7.5A			
		High Capacity Type	NO	4000V AC	2000VA	250V AC	16A	8A	16A	AC250V	DC5V
			NC	4000V AC	2000VA	250V AC	16A	8A			
	2 poles	NO	2000V AC	1000VA	250V AC	8A	4A	8A	AC250V	DC5V	
			240W	120W	30V DC	8A	4A				
		NC	2000V AC	1000VA	250V AC	8A	4A	4A	AC250V	DC125V	
			120W	60W	30V DC	4A	2A				
	2 poles (bifurcated contacts)	NO	250VA AC	100VA AC	250V AC	1A	0.4A	1A	250V AC	1V DC	
		NC	30W DC	15W DC	30V DC	1A	0.5A				125V DC

Contactors

Terminal Blocks

Circuit Breakers

Agency Ratings

Voltage	UL							
	General Use						Resistive	
	RJ1		RJ2		RJ22		RJ22	
	NO	NC	NO	NC	NO	NC	NO	NC
250V AC	16A	6A	8A	4A	1A	1A	—	—
30V DC	12A	6A	8A	4A	—	—	1A	1A

Voltage	CSA													
	General Use		Resistive						Inductive					
	RJ22		RJ1		RJ2		RJ22		RJ1		RJ2		RJ22	
	NO	NC	NO	NC	NO	NC	NO	NC	NO	NC	NO	NC	NO	NC
250V AC	1A	1A	12A	12A	8A	8A	—	—	7.5A	7.5A	4A	4A	—	—
30V DC	—	—	12A	6A	8A	4A	1A	1A	6A	3A	4A	2A	1A	1A

Voltage	VDE					
	Resistive				AC-15, DC-13*	
	RJ1	RJ2	RJ22		RJ1	RJ2
	NO	NO	NO	NC	NO	NO
250V AC	12A	8A	1A	1A	6A	3A
30V DC	12A	8A	1A	1A	2.5A	2A



*According to the utilization categories of IEC60947-5-1

Socket Specifications

	Socket	Terminal	Electrical Rating	Wire Size	Torque
DIN Rail/ Panel Mount	SJ1S-05BW	M3 screw with captive wire clamp	250V, 12A	Maximum up to 2 - #14 AWG	0.6 - 1.0N•m (Maximum 1.2N•m)
	SJ2S-05BW	M3 screw with captive wire clamp	250V, 8A	Maximum up to 2 - #14 AWG	0.6 - 1.0N•m (Maximum 1.2N•m)
Finger-safe DIN Rail/Panel Mount	SJ1S-07LW	M3 screw with captive wire clamp, fingersafe	250V, 12A	Maximum up to 2 - #14 AWG	0.6 - 1.0N•m (Maximum 1.2N•m)
	SJ2S-07LW	M3 screw with captive wire clamp, fingersafe	250V, 8A	Maximum up to 2 - #14 AWG	0.6 - 1.0N•m (Maximum 1.2N•m)
	SQ1V-07B	M3 screw with box clamp, fingersafe	300V, 12A	Maximum up to 2 - #14 AWG	1.0N•m Maximum
	SQ2V-07B	M3 screw with box clamp, fingersafe	300V, 10A	Maximum up to 2 - #14 AWG	1.0N•m Maximum
PCB Mount	SJ1S-61	PCB mount	250V, 12A	—	—
	SJ2S-61	PCB mount	250V, 8A	—	—
	SQ1V-63	PCB mount	300V, 12A	—	—
	SQ2V-63	PCB mount	300V, 12A	—	—

Switches & Pilot Lights

Signaling Lights

Relays & Sockets

Timers

Contactors

Terminal Blocks

Circuit Breakers

Electrical Life Curve (Resistive Load)

RJ1

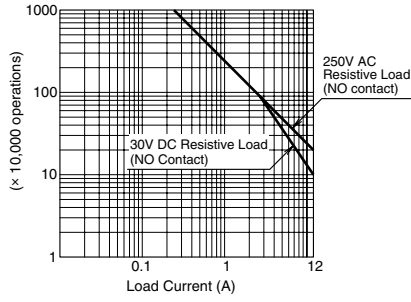

RJ1 High Capacity

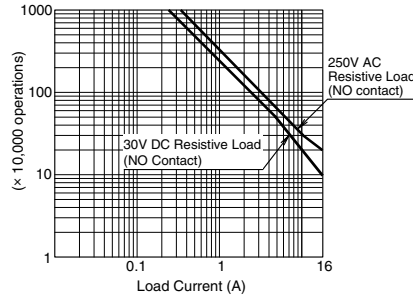

RJ2

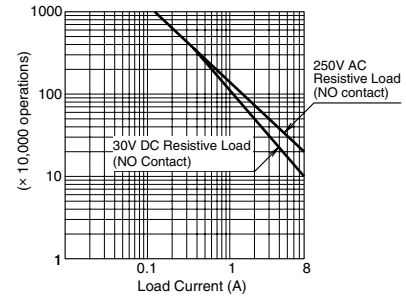

Maximum Switching Capacity (Resistive Load)

RJ1

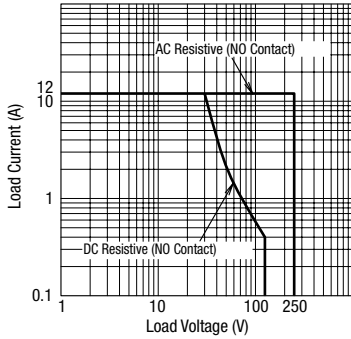

RJ1 High Capacity

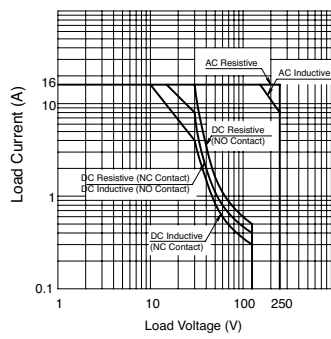

RJ2

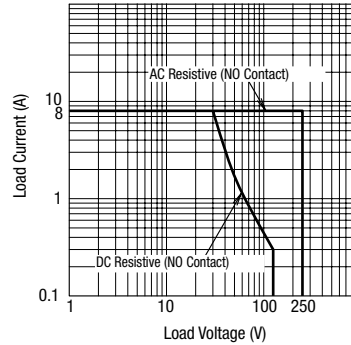

Operating Temperature and Coil Temperature Rise

RJ1 (AC Coil, 60 Hz)

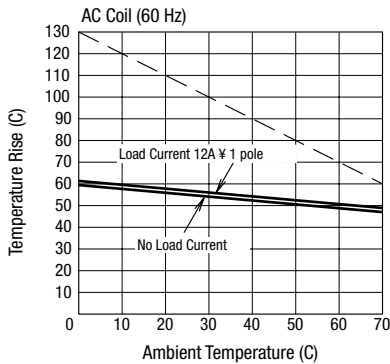

RJ1 (AC Coil, 50 Hz)

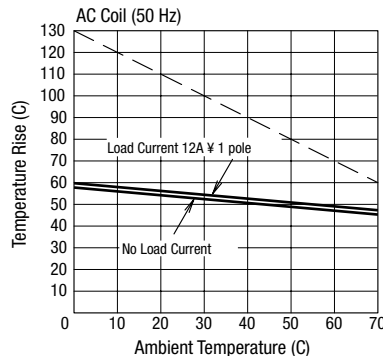

RJ1 (DC Coil)

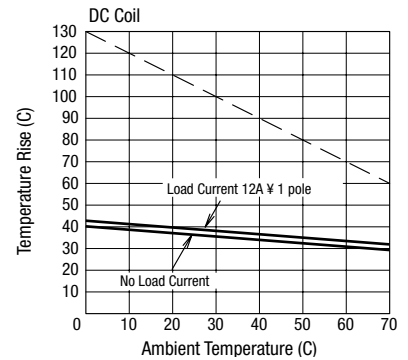

RJ2 (AC Coil, 60 Hz)

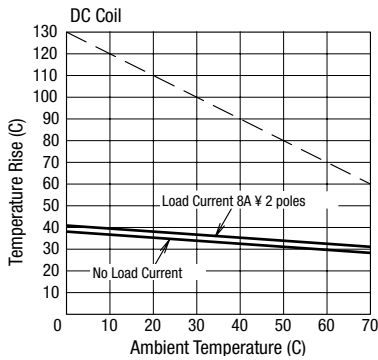

RJ2 (AC Coil, 50 Hz)

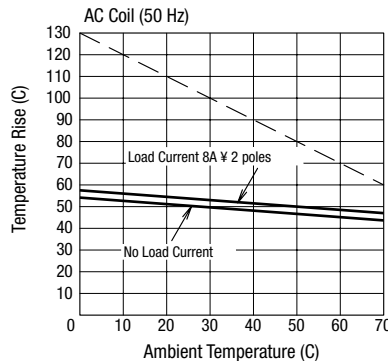

RJ2 (DC Coil)

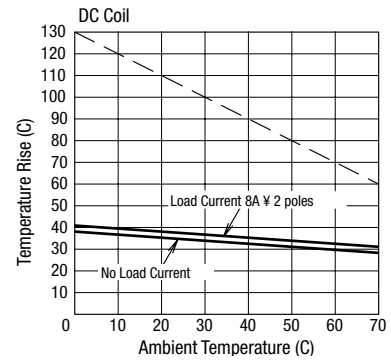

RJ22 (AC Coil, 60 Hz)

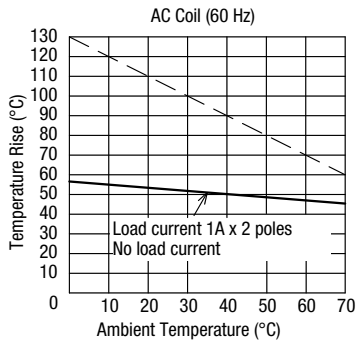

RJ22 (AC Coil, 50 Hz)

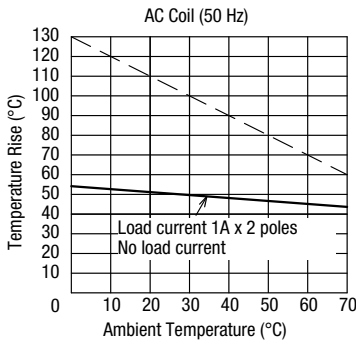

RJ22 (DC Coil)

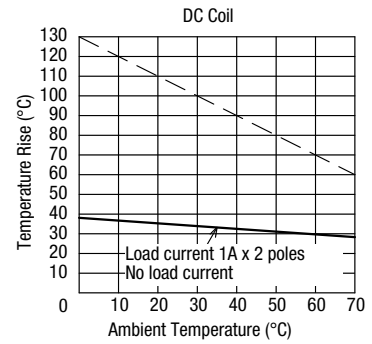

The above temperature rise curves show characteristics when 100% the rated coil voltage is applied. The slanted dashed line indicates allowable temperature rise for the coil at different ambient temperatures.

Internal Connection (View from Bottom)

RJ1-C-* Standard

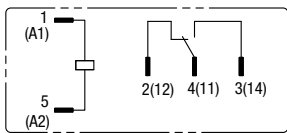

RJ1-CL-* With LED Indicator

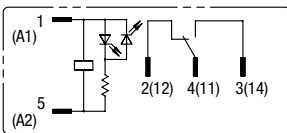

Coil voltage 24V AC/DC and below

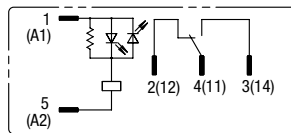

Coil voltage greater than 24V AC/DC

RJ1-CD-* With Diode

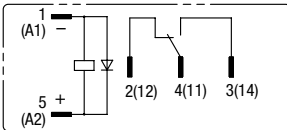

RJ1-CLD-* With LED Indicator and Diode

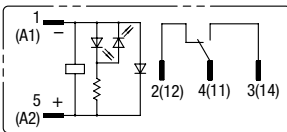

Coil voltage 24V DC and below

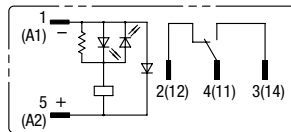

Coil voltage greater than 24V DC

RJ2-C/RJ22-C-* Standard

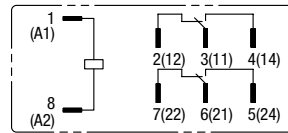

RJ22V-A-*

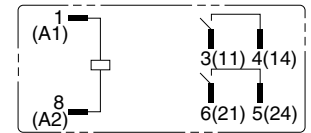

RJ2-CL/RJ22-CL-* With LED Indicator

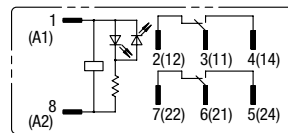

Coil voltage 24V AC/DC and below

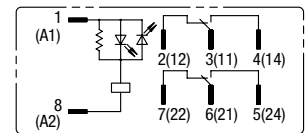

Coil voltage greater than 24V AC/DC

RJ2-CD-/ RJ22-CD-* With Diode

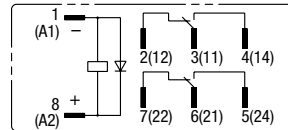

RJ2-CLD/ RJ22-CLD-* With LED Indicator and Diode

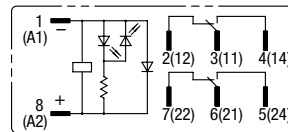

Coil voltage 24V DC and below

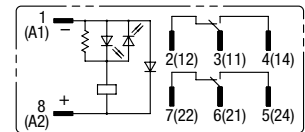

Coil voltage greater than 24V DC

Dimensions (mm)

Blade Relay (mm)

RJ1S

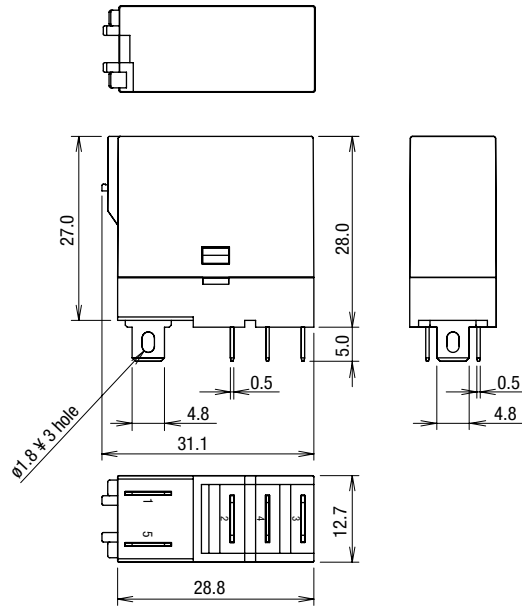

RJ2S/RJ22S

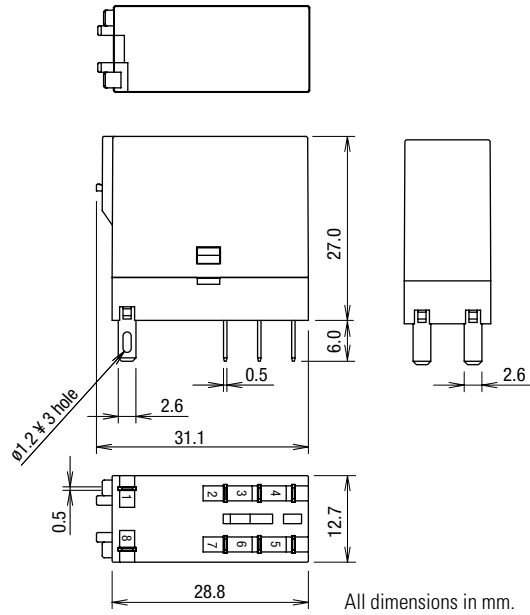

All dimensions in mm.

PCB Relay (mm)

RJ1V-C-*

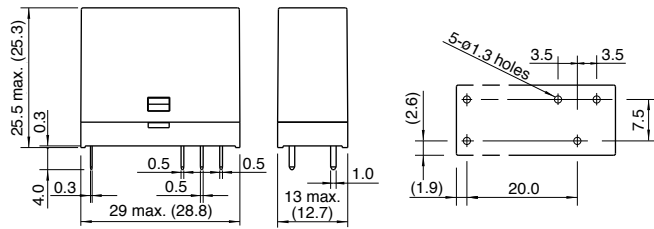

RJ1V-A-*

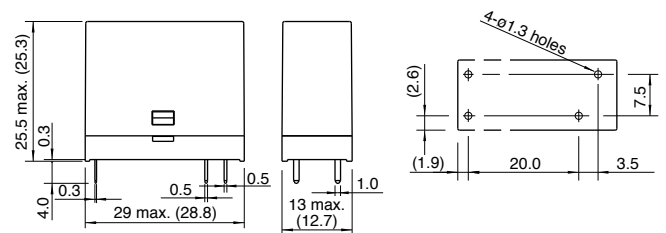

RJ1V-CH-*/RJ2V-C-*

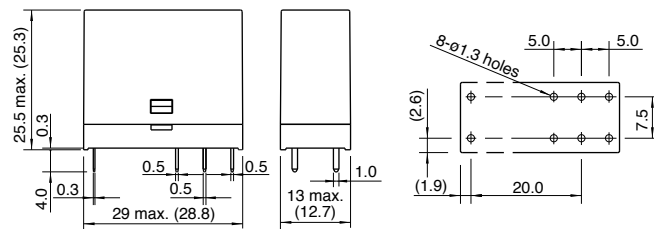

RJ1V-AH-*/RJ2V-A-*

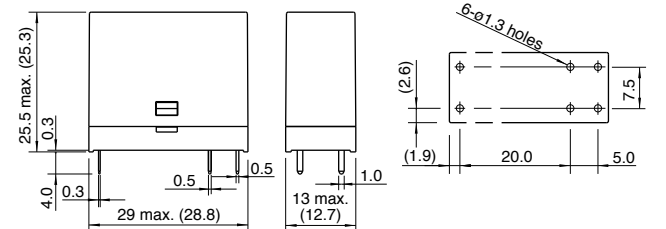

RJ22V-C-*

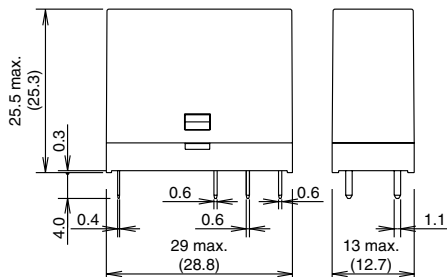

RJ22V-A-*

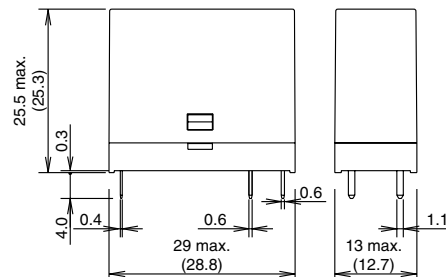

Dimensions con't (mm)

Standard DIN Rail Mount Sockets

SJ1S-05BW

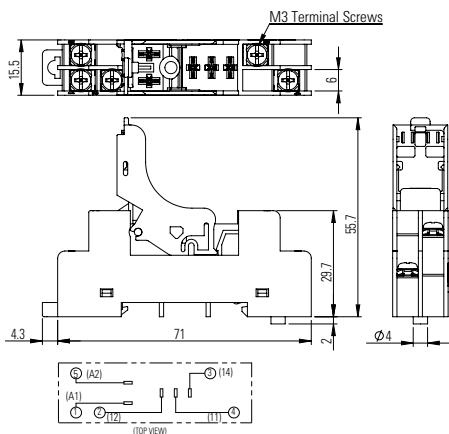

SJ2S-05BW

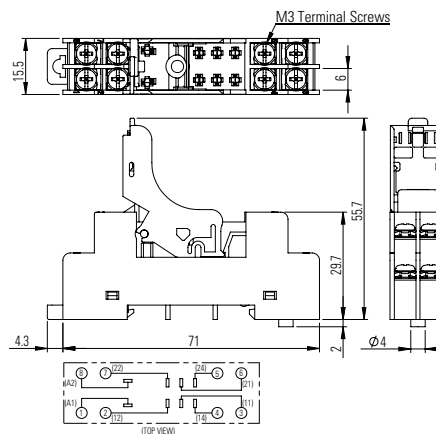

Finger-safe DIN Rail Mount Sockets

SJ1S-07LW

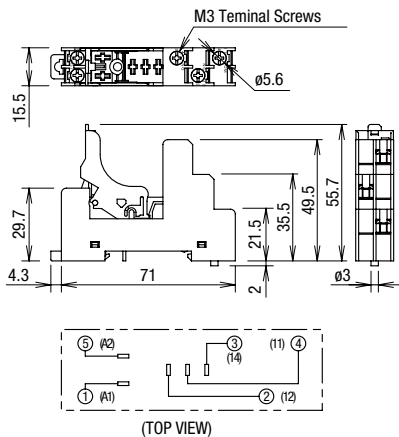

SJ2S-07LW

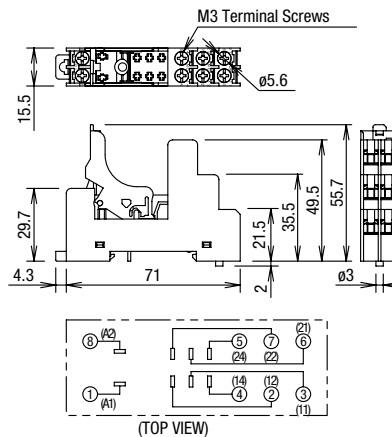

SQ1V-07B

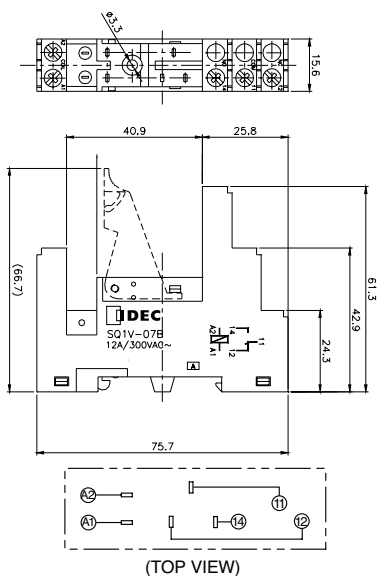

SQ2V-07B

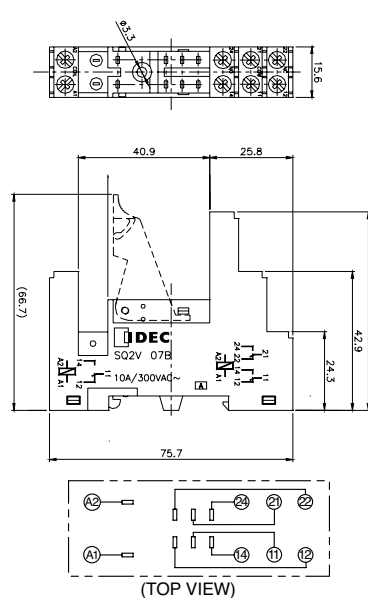

Switches & Pilot Lights

Signaling Lights

Relays & Sockets

Timers

Contactors

Terminal Blocks

Circuit Breakers

Dimensions con't (mm)

PC Mount Sockets

SJ1S-61

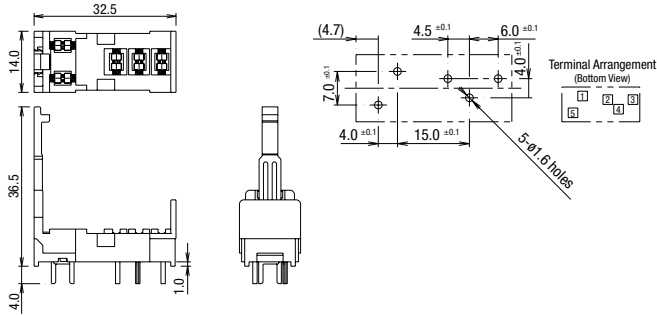

SJ2S-61

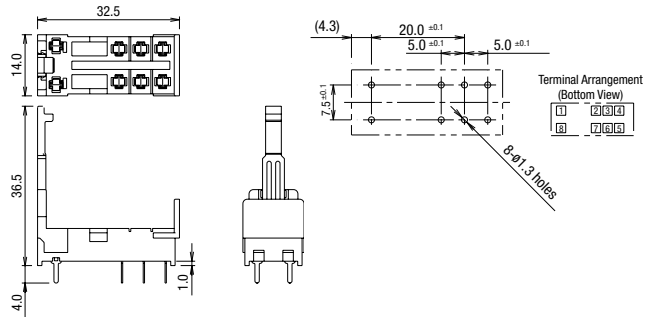

SQ1V-63

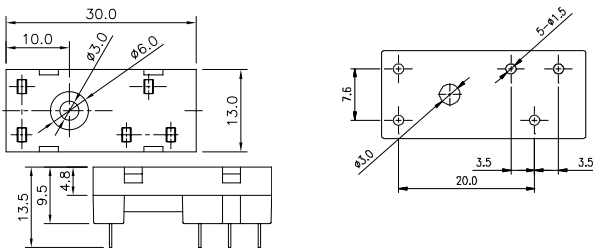

SQ2V-63

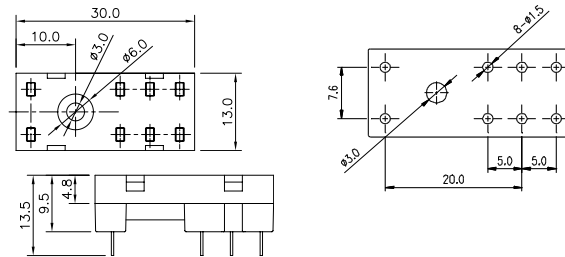

Switches & Pilot Lights

Signaling Lights

Relays & Sockets

Timers

Contactors

Terminal Blocks

Circuit Breakers

Operating Instructions

Driving Circuit for Relays

- To ensure correct relay operation, apply rated voltage to the relay coil.
- Input voltage for the DC coil:
A complete DC voltage is best for the coil power to make sure of stable relay operation. When using a power supply containing a ripple voltage, suppress the ripple factor within 5%. When power is supplied through a rectification circuit, the relay operating characteristics, such as pickup voltage and dropout voltage, depend on the ripple factor. Connect a smoothing capacitor for better operating characteristics as shown below.

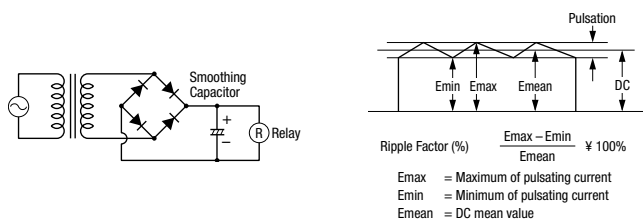

- Leakage current while relay is off:
When driving an element at the same time as the relay operation, special consideration is needed for the circuit design. As shown in the incorrect circuit below, leakage current (I_0) flows through the relay coil while the relay is off. Leakage current causes coil release failure or adversely affects the vibration resistance and shock resistance. Design a circuit as shown in the correct example.

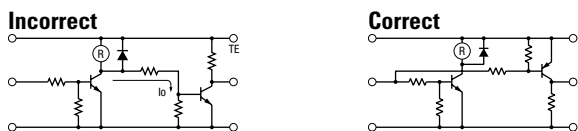

- Surge suppression for transistor driving circuits:
When the relay coil is turned off, a high-voltage pulse is generated, causing a transistor to deteriorate and sometimes to break. Be sure to connect a diode to suppress the back electromotive force. Then, the coil release time becomes slightly longer. To shorten the coil release time, connect a Zener diode between the collector and emitter of the transistor. Select a Zener diode with a Zener voltage slightly higher than the power voltage.

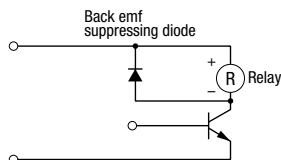

Protection for Relay Contacts

- The contact ratings show maximum values. Make sure that these values are not exceeded. When an inrush current flows through the load, the contact may become welded. If this is the case, connect a contact protection circuit, such as a current limiting resistor.
- Contact protection circuit:
When switching an inductive load, arcing causes carbides to form on the contacts, resulting in increased contact resistance. In consideration of contact reliability, contact life, and noise suppression, use of a surge absorbing circuit is recommended. Note that the release time of the load becomes slightly longer. Check the operation using the actual load. Incorrect use of a contact protection circuit will adversely affect switching characteristics. Four typical examples of contact protection circuits are shown in the following table:

RC	<p> <ul style="list-style-type: none"> R: Resistor of approximately the same resistance value as the load C: 0.1 to 1 μF </p>
Diode	<p> This protection circuit can be used for DC load power circuits. Use a diode with the following ratings. Reverse withstand voltage: Power voltage of the load circuit x 10 Forward current: More than the load current </p>
Varistor	<p> This protection circuit can be used for both AC and DC load power circuits. For a best result, when using a power voltage of 24 to 48V AC/DC, connect a varistor across the load. When using a power voltage of 100 to 240V AC/DC, connect a varistor across the contacts. </p>

- Do not use a contact protection circuit as shown below:

	<p>This protection circuit is very effective in arc suppression when opening the contacts. But, the capacitor is charged while the contacts are opened. When the contacts are closed, the capacitor is discharged through the contacts, increasing the possibility of contact welding.</p>
	<p>This protection circuit is very effective in arc suppression when opening the contacts. But, when the contacts are closed, a current flows to charge the capacitor, causing contact welding.</p>

Generally, switching a DC inductive load is more difficult than switching a DC resistive load. Using an appropriate arc suppressor, however, will improve the switching characteristics of a DC inductive load.

Soldering

- When soldering the relay terminals, use a soldering iron of 30 to 60W, and quickly complete soldering (within approximately 3 seconds).
- Use a non-corrosive rosin flux.

Switches & Pilot Lights

Signaling Lights

Relays & Sockets

Timers

Contactors

Terminal Blocks

Circuit Breakers

Operating Instructions con't

Other Precautions

1. General notice:

To maintain the initial characteristics, do not drop or shock the relay.

The relay cover cannot be removed from the base during normal operation. To maintain the initial characteristics, do not remove the relay cover.

Use the relay in environments free from condensation, dust, sulfur dioxide (SO₂), and hydrogen sulfide (H₂S).

Make sure that the coil voltage does not exceed applicable coil voltage range.

2. UL and CSA ratings may differ from product rated values determined by IDEC.

3. Do not use relays in the vicinity of strong magnetic field, as this may affect relay operation.

Safety Precautions

- Turn off the power to the relay before starting installation, removal, wiring, maintenance, and inspection of the relays. Failure to turn power off may cause electrical shock or fire hazard.
- Observe specifications and rated values, otherwise electrical shock or fire hazard may be caused.
- Use wires of the proper size to meet voltage and current requirements. Tighten the terminal screws on the relay socket to the proper tightening torque.
- Surge absorbing elements on AC relays with RC or DC relays with diode are provided to absorb the back electromotive force generated by the coil. When the relay is subject to an excessive external surge voltage, the surge absorbing element may be damaged. Add another surge absorbing provision to the relay to prevent damage.

Precautions for the RU Relays

- Before operating the latching lever of the RU relay, turn off the power to the RU relay. After checking the circuit, return the latching lever to the original position.
- Do not use the latching lever as a switch. The durability of the latching lever is a minimum of 100 operations.
- When using DC loads on 4PDT relays, apply a positive voltage to terminals of neighboring poles and a negative voltage to the other terminals of neighboring poles to prevent the possibility of short circuits.
- DC relays with a diode have a polarity in the coil terminals. Apply the DC voltage to the correct terminals.