

DO NOT SCALE FROM THIS PRINT

No OF POSITIONS

-02 THRU -40 (PER ROW)

LEAD STYLE

-02: SURFACE MOUNT

POLARIZING OPTION

-XXX INDICATES POSITION No (USE PK-07-N)

OPTION

- LC: LOCKING CLIP (NOT AVAILABLE ON -SV) (USE LC-06-TM, SEE FIG 1, FIG 2 & 3, SHT 2 & NOTES 6 & 7)
- P: PICK & PLACE PAD (ONLY AVAILABLE ON -SV & -DV, 4 POS MIN) (-SV: USE PPP-09; -DV: USE PPP-03; SEE FIG 5, SHT 2)
- M: METAL PICK & PLACE PAD (ONLY AVAILABLE ON -DV) (USE LMP-03, SEE FIG 7, SHT 3)
- A: MOLDED ALIGNMENT PIN (AVAILABLE ON -DV ONLY) (USE MMS-XX-D-VXX, SEE FIG 4, SHT 3)
- K: POLYIMIDE FILM PAD (AVAILABLE ON 3 POS MIN, FOR -SV USE K-DOT-.118-.219-.005, FOR -DV USE K-DOT-.217-.313-.005) (SEE FIG 6, SHT 3)
- TR: TAPE & REEL PACKAGING (SEE FIG 8, SHT 4) (AVAILABLE ON 2-36 POS ONLY)

PLATING SPECIFICATION

- S: 30μ" SELECTIVE GOLD IN CONTACT AREA, MATTE TIN TAIL
- L: 10μ" SELECTIVE GOLD IN CONTACT AREA, MATTE TIN TAIL
- F: 3μ" SELECTIVE GOLD IN CONTACT AREA, MATTE TIN TAIL
- \*\* -T: MATTE TIN OVER ENTIRE CONTACT
- LTL: 10μ" SELECTIVE GOLD IN CONTACT AREA, TIN LEAD (90/10 ±5%) TAIL
- SM: 30μ" SELECTIVE GOLD IN CONTACT AREA, MATTE TIN TAIL
- LM: 10μ" SELECTIVE GOLD IN CONTACT AREA, MATTE TIN TAIL
- FM: 3μ" SELECTIVE GOLD IN CONTACT AREA, MATTE TIN TAIL
- \*\* -TM: MATTE TIN OVER ENTIRE CONTACT
- H: 30μ" GOLD IN CONTACT AREA, 3μ" GOLD ON TAIL

ENTRY/ROW SPECIFICATION

- SH: SINGLE ROW, HORIZONTAL ENTRY
- DH: DOUBLE ROW, HORIZONTAL ENTRY
- SV: SINGLE ROW, VERTICAL (TOP) ENTRY
- DV: DOUBLE ROW, VERTICAL (TOP) ENTRY

\*\* = AVAILABLE TO EXISTING CUSTOMERS ONLY

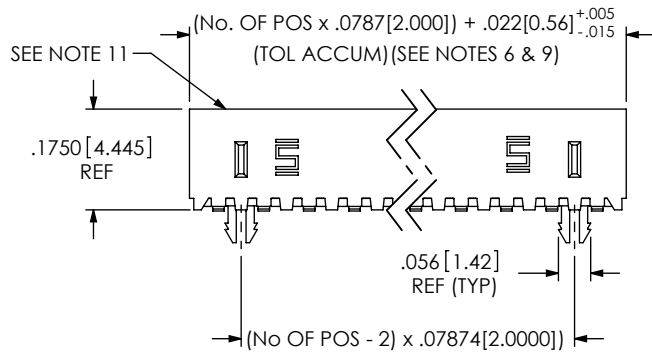
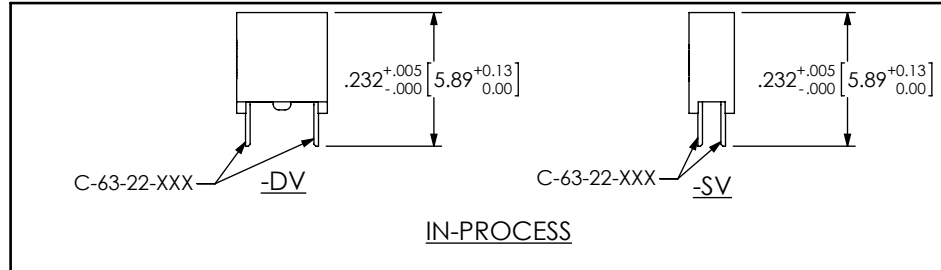
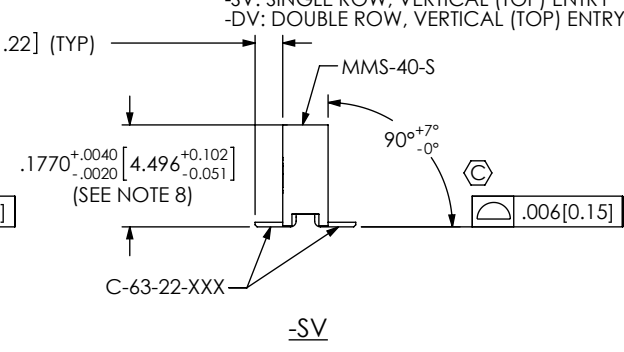
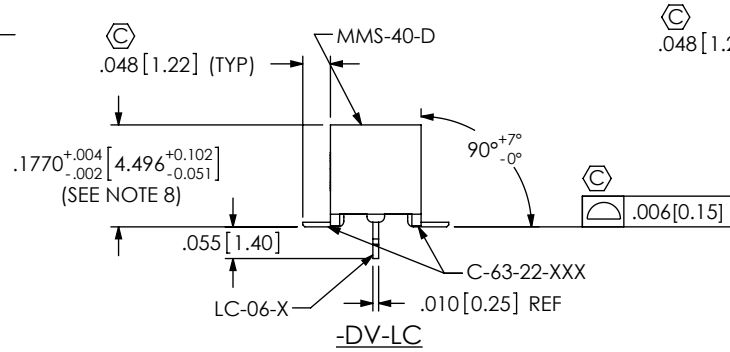


FIG 1 MMS-140-02-XXX-XV-LC SHOWN



NOTES:

1. Ⓢ REPRESENTS A CRITICAL DIMENSION.
2. MAXIMUM ALLOWABLE SWAY: 2° IN EITHER DIRECTION
3. MAXIMUM BURR ALLOWANCE: .003[0.08]
4. MAXIMUM CUT FLASH: .020[0.51].
5. MINIMUM RETENTION FORCE: SINGLE ROW: .5 LB, DOUBLE ROW: 1 LB
6. CUT BODIES FROM MMS-40-D OR MMS-40-S FOR ALL STYLES EXCEPT -LC. FOR -LC, USE POSITIONALIZED BODIES. 3 POSITION -DV-LC PARTS WILL HAVE 1 LOCKING CLIP.
7. DUE TO THE HIGH AMOUNT OF INSERTION FORCE NEEDED, THE -LC OPTION IS NOT COMPATIBLE WITH AUTO PLACEMENT. SAMTEC RECOMMENDS MANUAL PLACEMENT FOR ALL ASSEMBLIES WITH THE -LC OPTION.
8. THIS DIMENSION TO BE MEASURED AT BEND.
9. FOR -SV LEAD STYLE, EVEN POSITION CUTS LOSE 2 POSITIONS PER CUT; ODD POSITION CUTS LOSE 1 POSITION PER CUT.
10. LEAD STYLE -02-SH, POSITIONS 2 THRU 4 TO BE PACKAGED IN BOXES. ALL OTHER ROW SPECIFICATIONS SHOULD BE TUBED ACCORDING TO TABLE 2, REGARDLESS OF POSITION.
11. PK-07-N TO BE INSERTED FROM THIS SIDE.

UNLESS OTHERWISE SPECIFIED, DIMENSIONS ARE IN INCHES.

TOLERANCES ARE:

| DECIMALS             | ANGLES |
|----------------------|--------|
| .XX: ±.01 [.3]       | 2°     |
| .XXX: ±.005 [.13]    |        |
| .XXXX: ±.0020 [.051] |        |

PROPRIETARY NOTE

THIS DOCUMENT CONTAINS INFORMATION CONFIDENTIAL AND PROPRIETARY TO SAMTEC, INC. AND SHALL NOT BE REPRODUCED OR TRANSFERRED TO OTHER DOCUMENTS OR DISCLOSED TO OTHERS OR USED FOR ANY PURPOSE OTHER THAN THAT WHICH IT WAS OBTAINED WITHOUT THE EXPRESSED WRITTEN CONSENT OF SAMTEC, INC.

MATERIAL: DO NOT SCALE DRAWING SHEET SCALE: 3:1

INSULATOR: VECTRA E130I, COLOR: BLACK CONTACT: PHOS BRONZE

DESCRIPTION:

2mm SURFACE MOUNT BOX CONNECTOR STRIP ASM

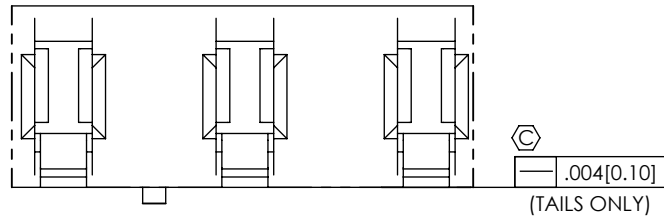
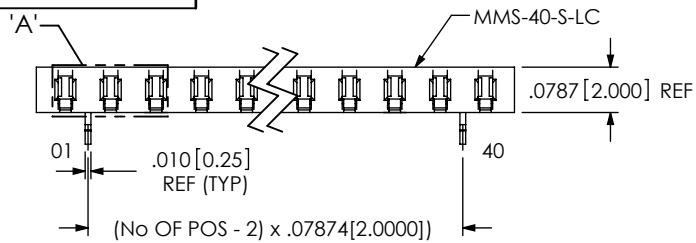
DWG. NO.

MMS-1XX-02-XXX-XX-XX-XXX

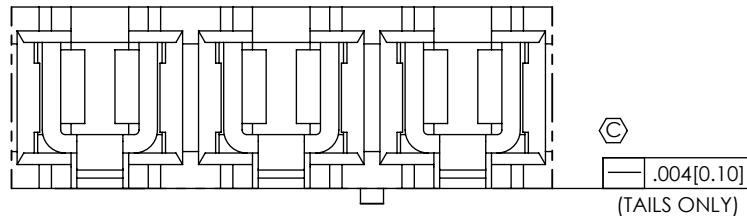
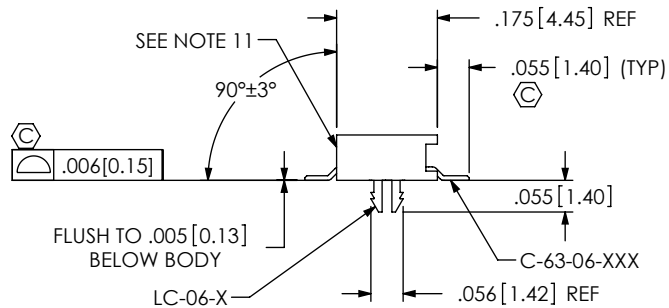
BY: BRATCHER 04/01/1994

SHEET 1 OF 4

REVISION CL

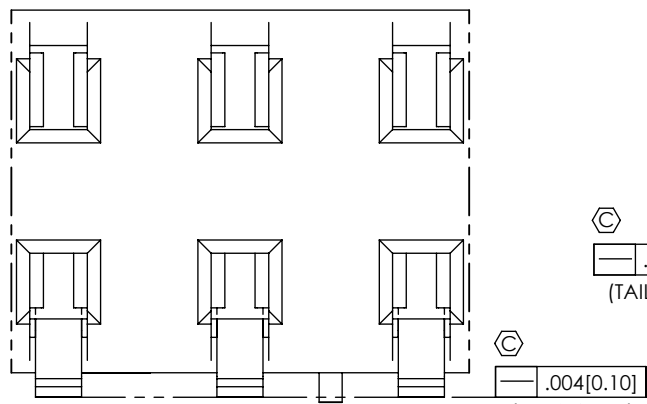
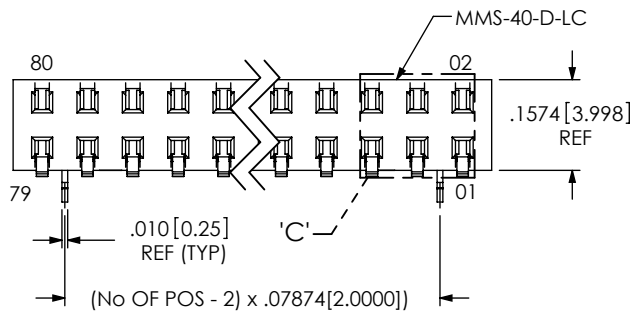
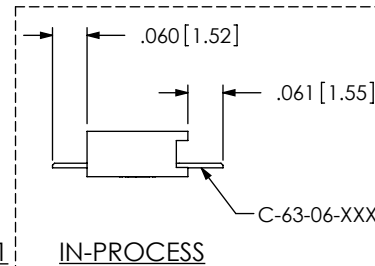
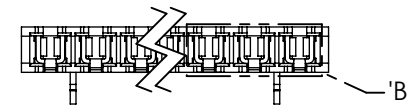


DETAIL 'A'  
SCALE 12 : 1

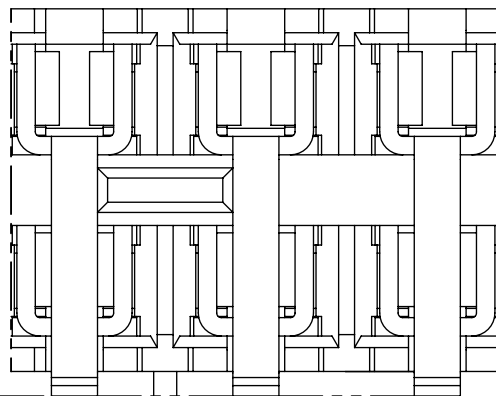
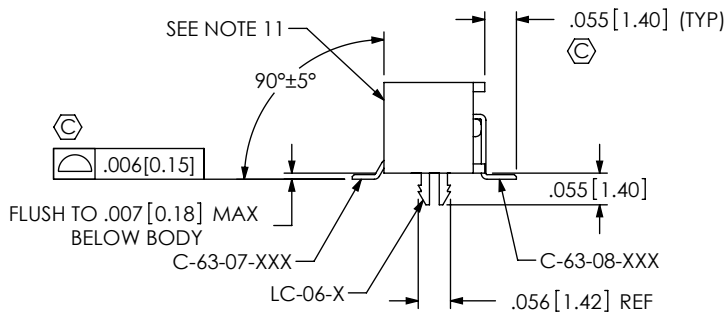


DETAIL 'B'  
SCALE 12 : 1

FIG 2  
MMS-140-02-XXX-SH-LC SHOWN

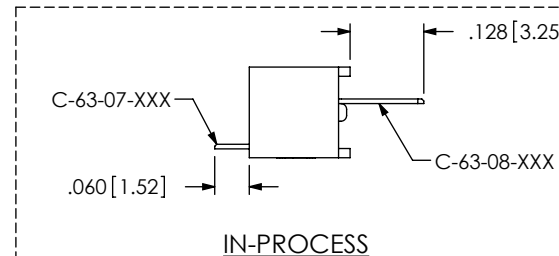
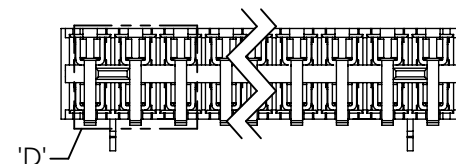


DETAIL 'C'  
SCALE 12 : 1



DETAIL 'D'  
SCALE 12 : 1

FIG 3  
MMS-140-02-XXX-DH-LC SHOWN



PROPRIETARY NOTE  
THIS DOCUMENT CONTAINS INFORMATION  
CONFIDENTIAL AND PROPRIETARY TO  
SAMTEC, INC. AND SHALL NOT BE REPRODUCED  
OR TRANSFERRED TO OTHER DOCUMENTS OR  
DISCLOSED TO OTHERS OR USED FOR ANY  
PURPOSE OTHER THAN THAT WHICH IT WAS  
OBTAINED WITHOUT THE EXPRESSED WRITTEN  
CONSENT OF SAMTEC, INC.

DO NOT SCALE DRAWING

SHEET SCALE: 3:1

**samtec**

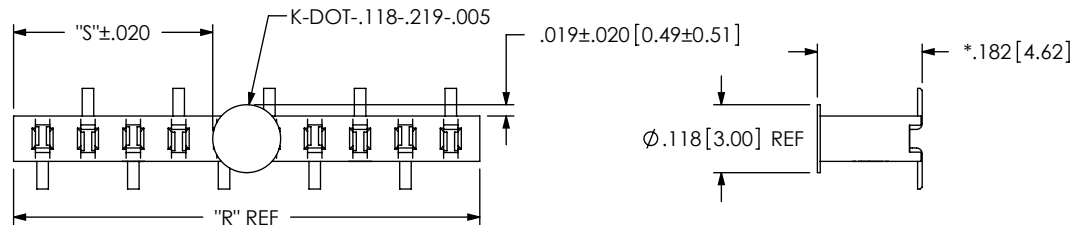
520 PARK EAST BLVD, NEW ALBANY, IN 47150  
PHONE: 812-944-6733 FAX: 812-948-5047  
e-Mail info@SAMTEC.com code 55322

DESCRIPTION:  
2mm SURFACE MOUNT BOX CONNECTOR STRIP ASM

DWG. NO.  
**MMS-1XX-02-XXX-XX-XX-XXX**

BY: BRATCHER 04/01/1994 SHEET 2 OF 4

"R" = USED MEASURED DIMENSION  
 "S" = ("R" - .118[3.00]) / 2  
 \*DIM WILL BE .187[4.75] IF POLARIZATION KEY IS UNDER PAD.



-SV-K

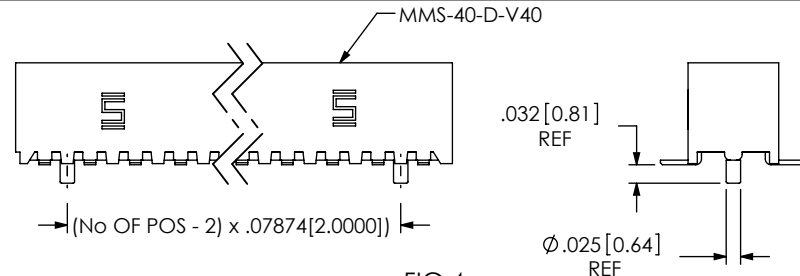
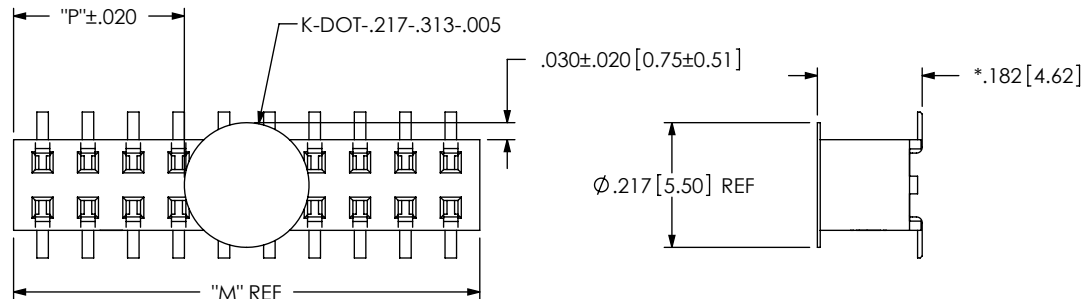


FIG 4  
 -A: MOLDED ALIGNMENT PIN  
 ONLY AVAILABLE ON -DV  
 (MMS-140-02-XXX-DV-A SHOWN)  
 (DIFFERENT AS SHOWN, OTHERWISE SAME AS FIG 1)

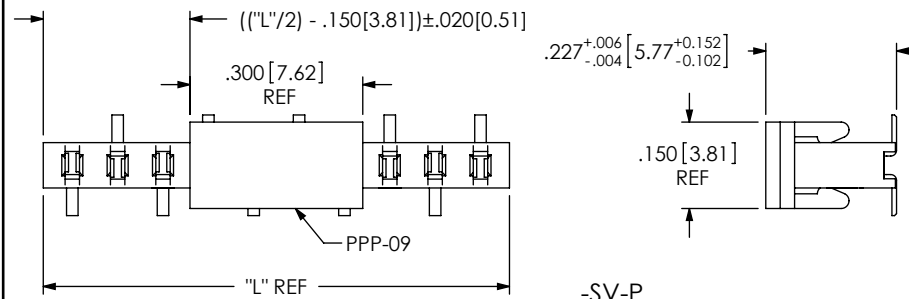
"M" = USED MEASURED DIMENSION  
 "P" = ("M" - .2165[5.50]) / 2  
 \*DIM WILL BE .187[4.75] IF POLARIZATION KEY IS UNDER PAD.



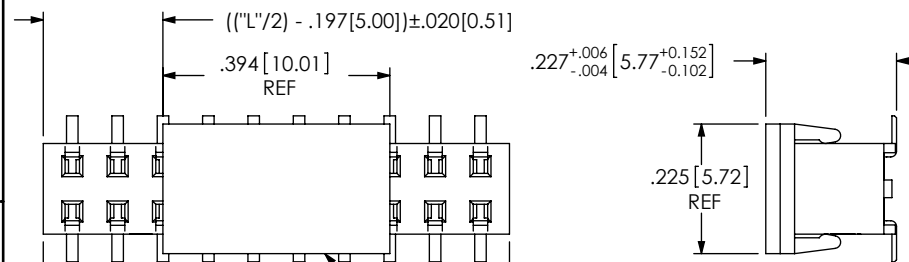
-DV-K

FIG 6  
 -K: POLYIMIDE FILM PAD  
 ONLY AVAILABLE ON -SV & -DV  
 (MMS-140-02-XXX-XV-K SHOWN)  
 (DIFFERENT AS SHOWN, OTHERWISE SAME AS FIG 1)

"L" = (No OF POSITIONS x .07874 [2.0000]) + .022 [0.56]



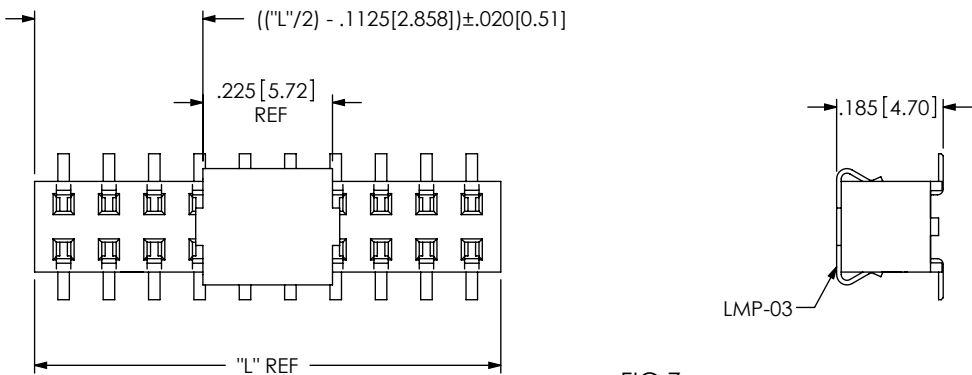
-SV-P



-DV-P

FIG 5  
 -P: PICK & PLACE PAD  
 ONLY AVAILABLE ON -SV & -DV  
 (MMS-140-02-XXX-XV-P SHOWN)  
 (DIFFERENT AS SHOWN, OTHERWISE SAME AS FIG 1)

"L" = (No OF POSITIONS x .07874 [2.0000]) + .022 [0.56]



LMP-03

FIG 7  
 -M: METAL PICK & PLACE PAD  
 ONLY AVAILABLE ON -DV  
 (MMS-140-02-XXX-DV-M SHOWN)  
 (DIFFERENT AS SHOWN, OTHERWISE SAME AS FIG 1)

PROPRIETARY NOTE

THIS DOCUMENT CONTAINS INFORMATION CONFIDENTIAL AND PROPRIETARY TO SAMTEC, INC. AND SHALL NOT BE REPRODUCED OR TRANSFERRED TO OTHER DOCUMENTS OR DISCLOSED TO OTHERS OR USED FOR ANY PURPOSE OTHER THAN THAT WHICH IT WAS OBTAINED WITHOUT THE EXPRESSED WRITTEN CONSENT OF SAMTEC, INC.

DO NOT SCALE DRAWING

SHEET SCALE: 3:1

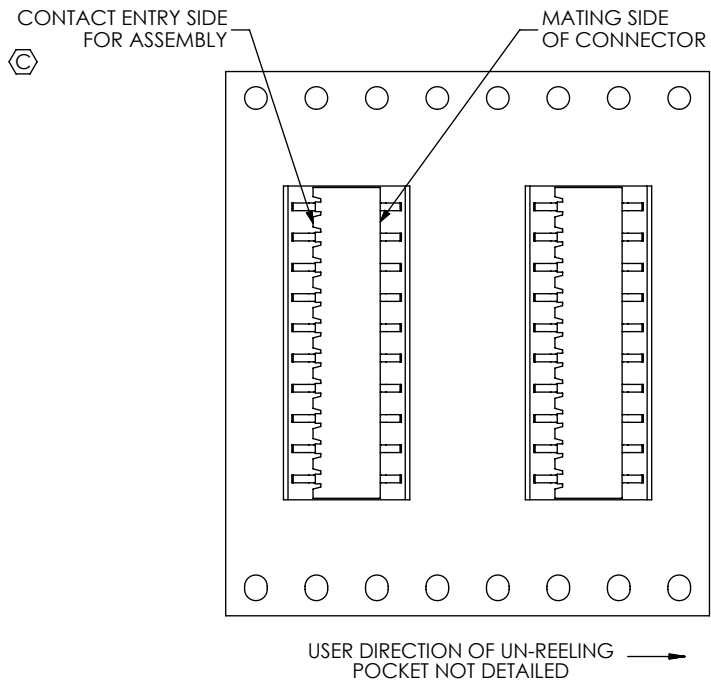


520 PARK EAST BLVD, NEW ALBANY, IN 47150  
 PHONE: 812-944-6733 FAX: 812-948-5047  
 e-Mail info@SAMTEC.com code 55322

DESCRIPTION:  
 2mm SURFACE MOUNT BOX CONNECTOR STRIP ASM

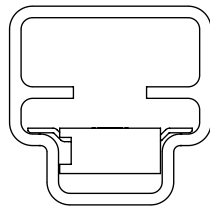
DWG. NO.  
**MMS-1XX-02-XXX-XX-XX-XXX**

BY: BRATCHER 04/01/1994 SHEET 3 OF 4

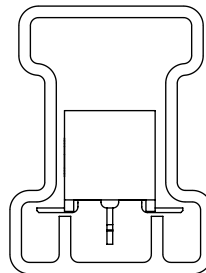


**FIG 8**  
 -TR: TAPE & REEL PACKAGING  
 MMS-110-02-XXX-SH SHOWN FOR ORIENTATION OF -SH & -DH STYLES  
 (MMS-103-02-X-LC, POS 1 TO FACE ROUND HOLES)

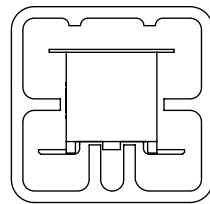
**FIG 9**  
 TUBE PACKAGING OPTIONS



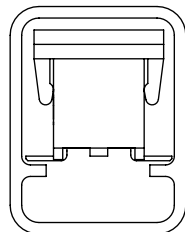
**\*\* -SH, -SH-LC**  
**\*\* -SH STYLE SHOWN**



**-DV (NOT 4 POS), -DV-LC, -DV-A**  
**-DV-LC STYLE SHOWN**



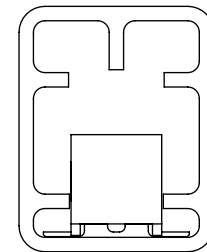
**-DV-K, -DV-LC-K, -DV-A-K**  
**-DV-K STYLE SHOWN**



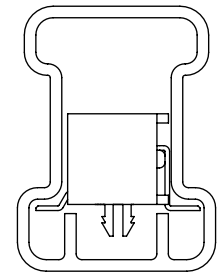
**-DV-P, -DV-LC-P, -DV-A-P**  
**-DV-P STYLE SHOWN**

| TABLE 2 (#1 POSITION TO BE TUBED IN DIRECTION OF ARROW) |                |       |
|---|----------------|-------|
| LEAD STYLE  | PACKAGING TUBE | PLUG  |
| -DV (NOT 4 POS), -DV-LC, -DV-A                          | PT-1-24-02-17  | TP-09 |
| -DV (4 POS ONLY)  | PT-1-24-01-118 | TP-09 |
| -DV-M, -DV-LC-M, -DV-A-M                                | PT-1-24-01-63  | TP-24 |
| -DV-K, -DV-LC-K, -DV-A-K                                | PT-1-24-02-63  | TP-24 |
| -DV-P, -DV-LC-P, -DV-A-P                                | PT-BKT001      | TP-09 |
| ** -SH, -SH-LC  | PT-1-24-02-16  | TP-24 |
| -DH   | PT-1-24-02-17  | TP-03 |
| -DH-P, -DH-K  | PT-1-24-06-17  | TP-24 |
| -DH-LC  | PT-1-24-02-17  | TP-09 |
| -SV (NOT -02 THRU -04 POS)                              | PT-1-24-01-16  | TP-12 |
| -SV (-02 THRU -04 POS ONLY)                             | PT-1-24-01-68  | TP-12 |
| -SV-P   | PT-1-24-02-16  | TP-24 |
| -SV-K   | PT-1-24-03-63  | TP-24 |

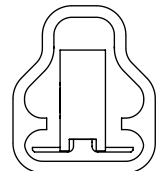
\*\*SEE NOTE 10



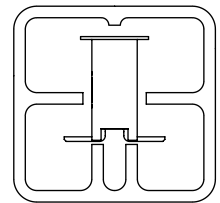
**-DV (4 POS ONLY)**



**-DH-LC**



**-SV (NOT -02 THRU -04 POS)**



**-SV -K**

**PROPRIETARY NOTE**  
 THIS DOCUMENT CONTAINS INFORMATION  
 CONFIDENTIAL AND PROPRIETARY TO  
 SAMTEC, INC. AND SHALL NOT BE REPRODUCED  
 OR TRANSFERRED TO OTHER DOCUMENTS OR  
 DISCLOSED TO OTHERS OR USED FOR ANY  
 PURPOSE OTHER THAN THAT WHICH IT WAS  
 OBTAINED WITHOUT THE EXPRESSED WRITTEN  
 CONSENT OF SAMTEC, INC.

DO NOT SCALE DRAWING

SHEET SCALE: 3:1

**samtec**

520 PARK EAST BLVD, NEW ALBANY, IN 47150  
 PHONE: 812-944-6733 FAX: 812-948-5047  
 e-Mail: info@SAMTEC.com code 55322

DESCRIPTION:  
 2mm SURFACE MOUNT BOX CONNECTOR STRIP ASM

DWG. NO.  
**MMS-1XX-02-XXX-XX-XX-XXX**

BY: BRATCHER 04/01/1994 SHEET 4 OF 4