

Multilayer Ceramic Chip Capacitors

Commercial Grade

Three-terminal Feed-through Type

CKD Series

Type:	CKD710JB	1005 [0402 inch]*
	CKD610JB	1608 [0603 inch]*
	CKD61BJB	1608 [0603 inch]*

* Dimensions Code JIS[EIA]

○ All specifications are subject to change without notice.

○ Conformity to RoHS Directive: This means that, in conformity with EU Directive 2002/95/EC, lead, cadmium, mercury, hexavalent chromium, and specific bromine-based flame retardants, PBB and PBDE, have not been used, except for exempted applications.

Multilayer Ceramic Chip Capacitors

Conformity to RoHS Directive
Lead-free Compatible

Commercial Grade

Three-terminal Feed-through Type

Overview of CKD Series

FEATURES

- Small capacitors featuring low ESL and high capacitance that realize low impedance characteristics.
- Effective for suppressing noise or voltage fluctuations in power circuits.
- For large current (Up to 2A) applications.

APPLICATIONS

For power lines of high-speed, large-current circuits of telecommunication terminal devices including smartphones, audio-visual equipment, and information equipment.

PART NUMBER IDENTIFICATION

CKD		710JB		0G		435		M		045		B			A
Series name	L x W dimensions - GND terminal width		Rated voltage		Capacitance		Tolerance		Thickness		Packing style			TDK internal code	
	Code	mm	Code	V	Code	pF			Code	mm	Code	Reel	Pitch		
	710JB	1.0x0.5 - 0.3	0G	4	105	1,000,000 (1.0μF)	M	±20%	030	0.3	A	ø178	4mm		
	610JB	1.6x0.8 - 0.4	0J	6.3			S	+50%/-20%	045	0.45	B	ø178	2mm		
	61BJB	1.6x0.8 - 0.8						060	0.6	D	ø330	4mm			
										E	ø330	2mm			

PACKAGING STYLE AND SPECIFICATIONS

Type	Package quantity (piece/reel)		Single weight (g)
	ø178	ø330	
CKD710JB	10,000	50,000	0.0008*
CKD610JB	4,000	10,000	0.0038
CKD61BJB	4,000	10,000	0.0038

* In the case of CKD710JB0G435M, the weight is 0.0015g.

○ Conformity to RoHS Directive: This means that, in conformity with EU Directive 2002/95/EC, lead, cadmium, mercury, hexavalent chromium, and specific bromine-based flame retardants, PBB and PBDE, have not been used, except for exempted applications.

○ Please contact our Sales office when your application is considered the following:
The device's failure or malfunction may directly endanger human life (e.g. application for automobile/aircraft/medical/nuclear power devices, etc.)

○ All specifications are subject to change without notice.

Overview of CKD Series

RECOMMENDED SOLDERING CONDITION

REFLOW SOLDERING

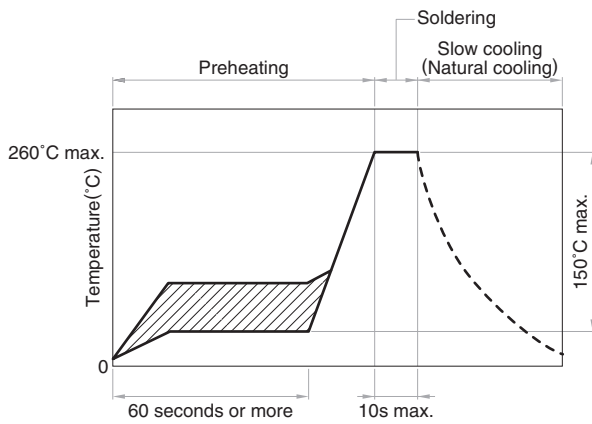

HAND SOLDERING

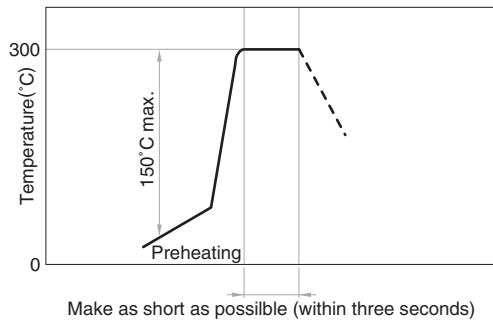

PRECAUTIONS FOR USE

- Before soldering, be sure to preheat components. The ΔT preheating temperature must be 150°C max. with attention paid to thermal shock.
- Natural cooling of components in the air is recommended. On the other hand, when dipping them in a solvent for purposes, such as cleaning, make sure that the temperature difference (ΔT) is 100°C.
- When performing hand soldering for circuit modification, apply the soldering iron to the copper foil area of the printed circuit board for 3 seconds or less. The temperature of the iron tip should not exceed 300°C.
- Use a wrist band to discharge static electricity in your body through the grounding wire.
- When incorporating the printed circuit board on which this product is mounted into a frame, etc., do not apply stress to the product through local bending of the board by tightening of screws, etc.

CKD Series CKD710JB Type

SHAPES AND DIMENSIONS

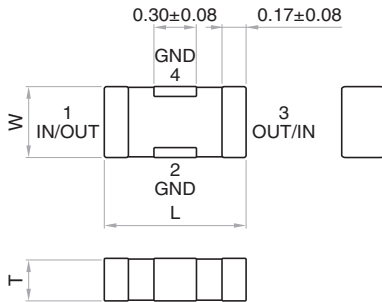

RECOMMENDED LAND PATTERN

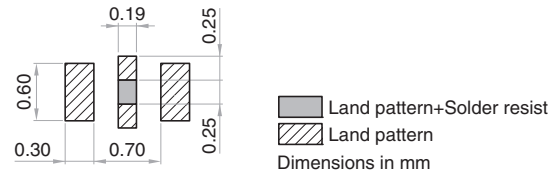

Part No.	L	W	T
CKD710JB0J474M030□A	1.00 ± 0.05	0.55 ± 0.05	0.30 ± 0.05
CKD710JB0J474S030□A	1.00 ± 0.05	0.55 ± 0.05	0.30 ± 0.05
CKD710JB0G105M030□A	1.00 ± 0.05	0.55 ± 0.05	0.30 ± 0.05
CKD710JB0G105S030□A	1.00 ± 0.05	0.55 ± 0.05	0.30 ± 0.05
CKD710JB0G435M045□A	1.05 ± 0.05	0.65 ± 0.05	0.45 ± 0.05

* Make sure to connect the GND terminal of this product and the GND of the mounting circuit board by using through holes so that the distance between them is the shortest.

ELECTRICAL CHARACTERISTICS

CHARACTERISTICS SPECIFICATION TABLE

Part No.	Capacitance (μF)	Tolerance (%)	Rated voltage Edc (V)	Rated current Idc (A)	Operating temperature range (°C)
CKD710JB0J474M030□A	0.47	±20	6.3	2	-55 to +105
CKD710JB0J474S030□A	0.47	+50/-20	6.3	2	-55 to +105
CKD710JB0G105M030□A	1.0	±20	4	2	-55 to +105
CKD710JB0G105S030□A	1.0	+50/-20	4	2	-55 to +105
CKD710JB0G435M030□A	4.3	±20	4	2	-55 to +85

* □: Please specify packing style code, B (ø178 reel 2mm-pitch) or E (ø330 reel 2mm-pitch).

ELECTRICAL CHARACTERISTICS GRAPH (EXAMPLE)

INSERTION LOSS vs. FREQUENCY CHARACTERISTICS

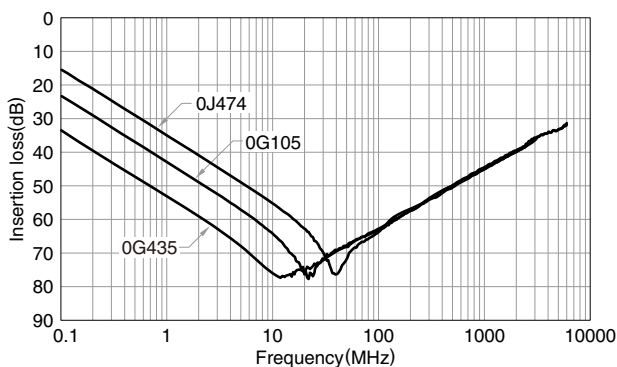

CKD Series CKD610JB Type

SHAPES AND DIMENSIONS

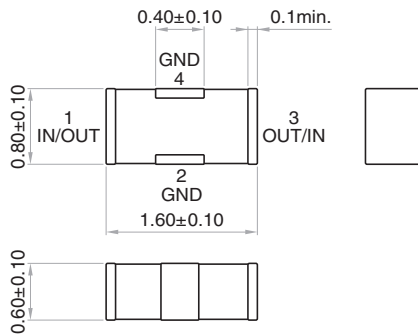

RECOMMENDED LAND PATTERN

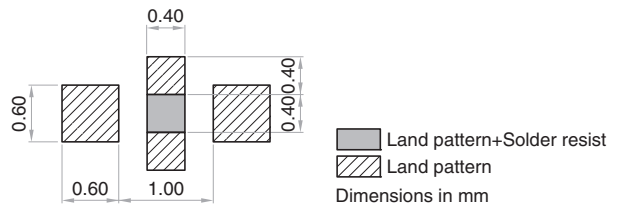

* Make sure to connect the GND terminal of this product and the GND of the mounting circuit board by using through holes so that the distance between them is the shortest.

ELECTRICAL CHARACTERISTICS

CHARACTERISTICS SPECIFICATION TABLE

Part No.	Capacitance (μF)	Tolerance (%)	Rated voltage Edc (V)	Rated current Idc (A)	Operating temperature range ($^{\circ}\text{C}$)
CKD610JB0J475M060□A	4.7	± 20	6.3	2	-55 to +85
CKD610JB0J475S060□A	4.7	+50/-20	6.3	2	-55 to +85

* □: Please specify packing style code, A ($\phi 178$ reel 4mm-pitch) or D ($\phi 330$ reel 4mm-pitch).

ELECTRICAL CHARACTERISTICS GRAPH (EXAMPLE)

INSERTION LOSS vs. FREQUENCY CHARACTERISTICS

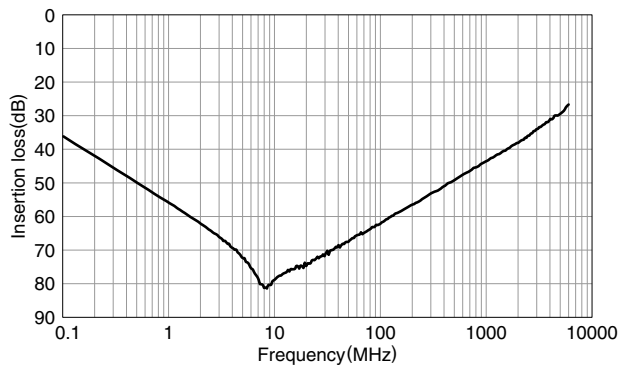

CKD Series CKD61BJB Type

SHAPES AND DIMENSIONS

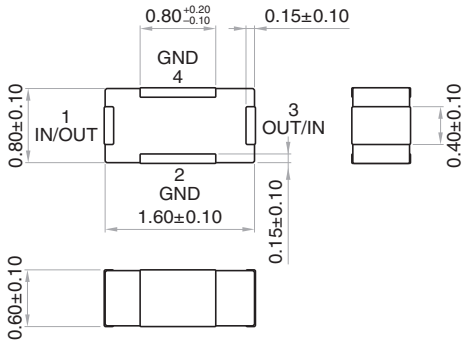

RECOMMENDED LAND PATTERN

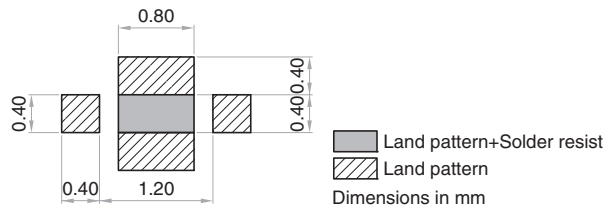

* Make sure to connect the GND terminal of this product and the GND of the mounting circuit board by using through holes so that the distance between them is the shortest.

ELECTRICAL CHARACTERISTICS

CHARACTERISTICS SPECIFICATION TABLE

Part No.	Capacitance (μF)	Tolerance (%)	Rated voltage Edc (V)	Rated current Idc (A)	Operating temperature range ($^{\circ}\text{C}$)
CKD61BJB0J105M060□A	1.0	± 20	6.3	2	-55 to +105
CKD61BJB0J105S060□A	1.0	+50/-20	6.3	2	-55 to +105
CKD61BJB0J475M060□A	4.7	± 20	6.3	2	-55 to +85
CKD61BJB0J475S060□A	4.7	+50/-20	6.3	2	-55 to +85

* □: Please specify packing style code, A ($\phi 178$ reel 4mm-pitch) or D ($\phi 330$ reel 4mm-pitch).

ELECTRICAL CHARACTERISTICS GRAPH (EXAMPLE)

INSERTION LOSS vs. FREQUENCY CHARACTERISTICS

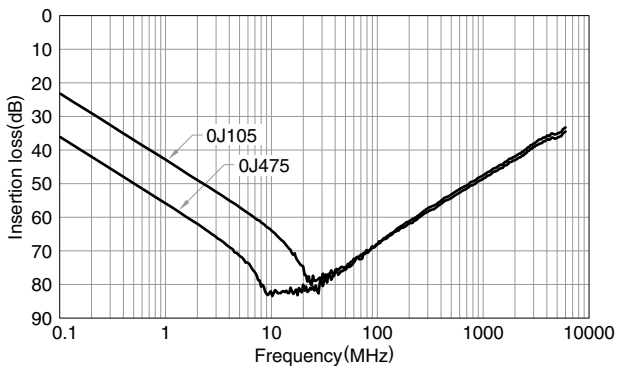

CKD Series Packing Style

REEL DIMENSIONS

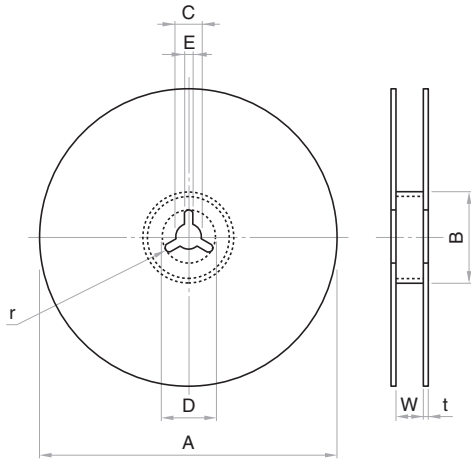

Dimensions in mm

Reel	A	B	C	D	E	W	t	r
ø178	ø178±2.0	ø60±2.0	ø13±0.5	ø21±0.8	2.0±0.5	9.0±0.3	2.0±0.05	1.0
ø330	ø382 max.(ø330 nom.)	ø50 min.	ø13±0.5	ø21±0.8	2.0±0.5	10.0±1.5	2.0±0.05	1.0

TAPE DIMENSIONS

Paper tape(Apply to the product less than 1.0 mm thick)

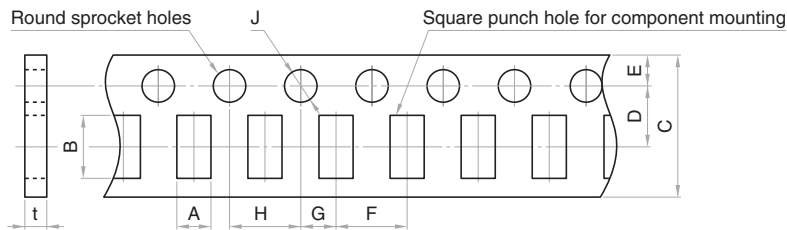

Dimensions in mm

Type	A	B	C	D	E	F	G	H	J	t
CKD710	0.62 typ.	1.12 typ.	8.0±0.3	3.5±0.05	1.75±0.1	2.0±0.1	2.0±0.05	4.0±0.1	ø1.5+0.1/-0	1.1 max.
CKD610	1.10 typ.	1.90 typ.	8.0±0.3	3.5±0.05	1.75±0.1	4.0±0.1	2.0±0.05	4.0±0.1	ø1.5+0.1/-0	1.1 max.
CKD61B										

Plastic tape

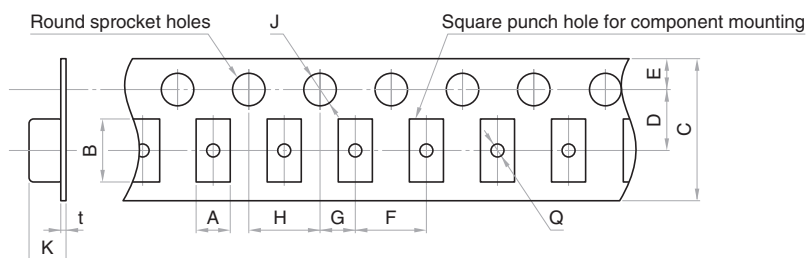

Mouser Electronics

Authorized Distributor

Click to View Pricing, Inventory, Delivery & Lifecycle Information:

TDK:

[CKD110JB1E220S](#) [CKD110JB1E470S](#) [CKD110JB1E101S](#) [CKD110JB1E221S](#) [CKD110JB1E471S](#)
[CKD110JB1E102S](#) [CKD110JB1E222S](#) [CKD110JB1E472S](#) [CKD110JB1E103S](#) [CKD110JB1E223S](#)
[CKD110JB1E473S](#) [CKD110JB1E104S](#) [CKD510JB1H220S](#) [CKD510JB1H470S](#) [CKD510JB1H101S](#)
[CKD510JB1H221S](#) [CKD510JB1H471S](#) [CKD510JB1H102S](#) [CKD510JB1H222S](#) [CKD510JB1H472S](#)
[CKD510JB1E103S](#) [CKD510JB1E223S](#) [CKD510JB1E473S](#) [CKD510JB1E104S](#) [CKD310JB1C104S](#)
[CKD310JB1C224S](#) [CKD310JB1C474S](#) [CKD510JB1A105S](#) [CKD61BJB0J474S](#) [CKD610JB0J105S](#)
[CKD610JB0J225S](#) [CKD310JB1C105S](#) [CKD310JB0J226S](#) [CKD61BJB0J105S](#) [CKD31C101H153M](#)
[CKD710JB0G105S](#) [CKD710JB0J474S](#) [CKD710JB1A224S](#) [CKD710JB1C104S](#)