

CLIFF

CONTROL KNOBS

**Knobs for Rotary and
Slider Potentiometers.**

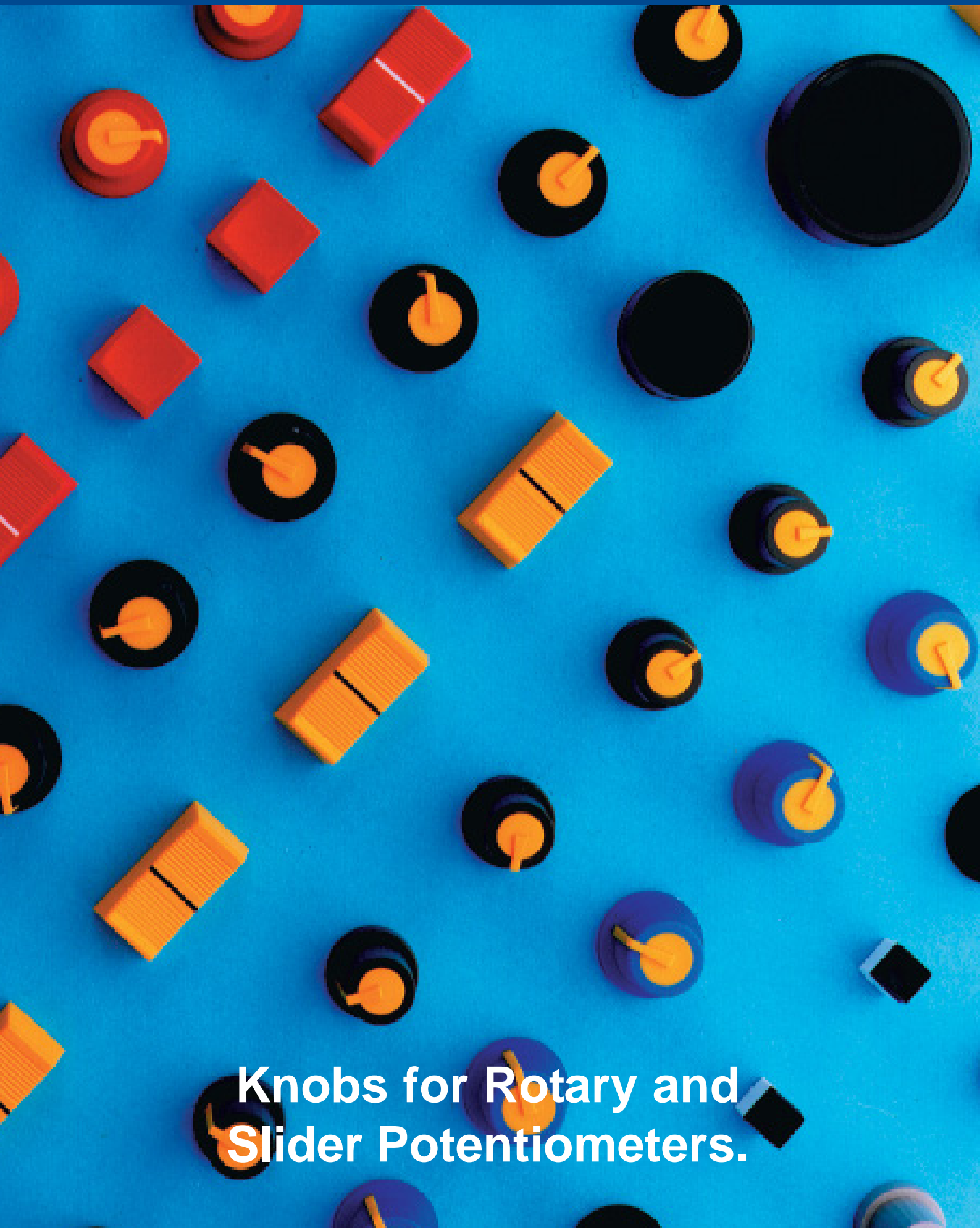

Instrument Control Knobs

We produce a versatile range of knobs designed to enhance the appearance - functionality of any equipment to which they are fitted. Knobs are made to high standards of finish in order to satisfy the users most exacting requirements.

All models are moulded in black Nylon, ABS or PP. Some models can be supplied in white or grey colours. Other custom made colours are produced subject to reasonable order quantity. (Sometimes setup charges are required). Some models can accept optional diamond spun caps or coloured caps. Marker dots are standard on models as indicated. The standard dot (or line) position is opposite to the set screw or 'D' flat.

Other variants are possible subject to our agreement. Refer to table on Page 8. for details of shaft sizes available.

Collet fitting using our low cost plastic collet system is available for K9 - K12 series.

2 colour moulded models K85M, K87MA, K87MB are suitable for mixing consoles. They combine good looks and ultimate low cost. Some models are available with rubber "Soft Touch" finish, ™ indicates 2 colour moulded.

Applications requiring similar style knobs of various sizes are well catered for in our range of models. When ordering - specify Quantity, Model, Colour, Fixing, Lines or Dots, Shaft size. If in doubt, refer to our Sales Office.

Example : K6 / black / SF / Marker dot / ¼" - or - K9 / black / marker line / 6mm. splined.

K1, K2

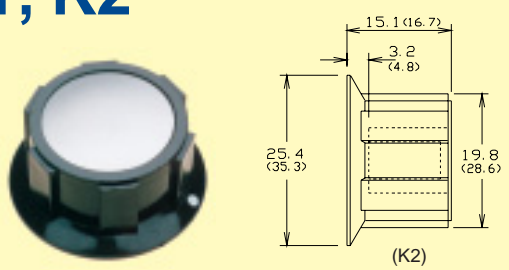

Practical low cost knobs. Often used in outdoors equipment. Chrome, Satin or coloured discs available. Marker dot on skirt is standard.

K1 - Packed 200 / bag.
K2 - Packed 100 / bag.

K3, K4



Pointer knobs with a matt textured finish. Marker line version is available.

K3, K4 - Packed 500 / bag.

See Page 8 for Shaft Options available.

K5, K6, K6/SKT



K5 - Marker line on top is optional (100 / box)
K6 - Screw fix only. Dot on top is optional (200 / box)
K6/SKT - Standard skirts are: Plain, 0-5-0 or 0-10.
Packed 200 / carton.

K7, K8

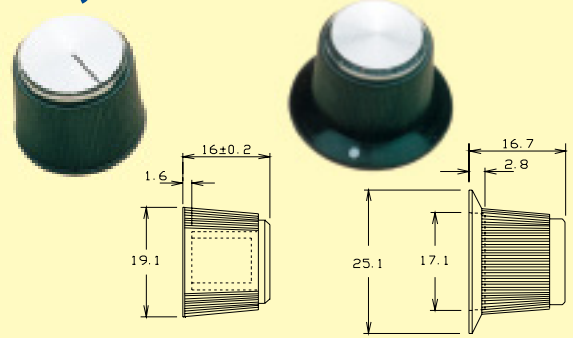

K7 - Marker line on top is optional.
K8 - Marker dot on skirt is standard.
Note: Both models can have a coloured plastic top (Min 1000)

Dimensions in mm.

K85

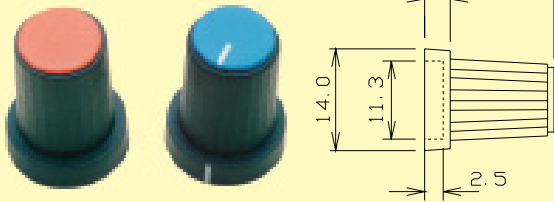

Available for push fitting only. 8 colours of cap are available. Caps push into the top of the knob, and can locate in any position. Skirt or cap or both may have a marker line. Supplied unassembled. Not available in rubber finish. Knobs packed 250 knobs / bag. Caps packed 100 or 1000 / bag.

K85M, K85MS

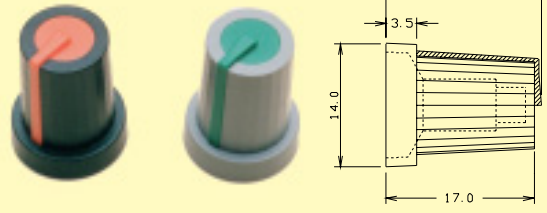

K85M - Available for push fit only. Two colour moulded. Body and line / cap can be 8 contrasting colours. Suitable for applications where quantities used demand very low cost. Not available with rubber finish. K85MS - (Under devt). Similar to K85M, but without skirt. Rubber finish is available. Packed 250 or 1000 / bag

All knobs on this page have complimentary design.

K87MA, K87MAR

Standard Top / Line
Colours
BLACK, WHITE, GREY, BLUE,
GREEN, RED, ORANGE, YELLOW

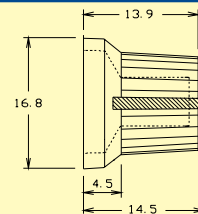

K87MA - Available for push fitting only. Hard finish version.
K87MAR - Is rubber finish (Soft Touch).
These are 2 colour moulded. We have 8 standard colours, and make custom versions subject to acceptable quantities. Knobs are low cost due to volume production. The coloured top helps identify colour coded grouped functions in equipment with many knobs.
Packed 250 or 1000 / bag.

See Page 8 for Shaft Options available.

K87MB, K87MBR

Standard Line Colours.
Same as K87MA

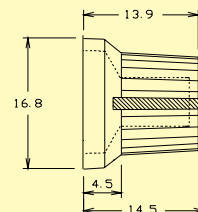

K87MB - Available for push fitting only. Hard finish version.
K87MBR - Is rubber finish (Soft Touch).
These knobs are similar to K87MA and MAR but without a coloured top. Used where colour coding is required to be more subtle. (marker line).
Packed 250 or 1000 / bag.

K9, K10

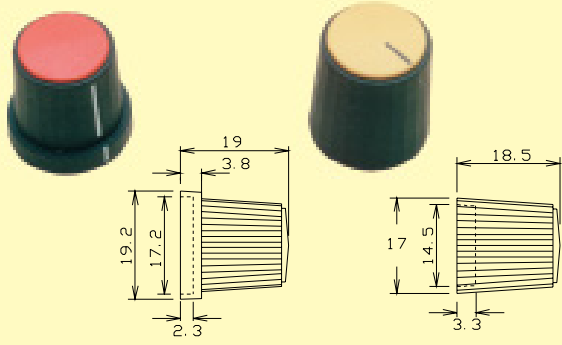

Both have separate push in caps. (8 colours).
Knob and cap can be plain or with a line.
K9, K10 - Packed 250 / bag.
Caps 100 or 1000 / bag.

K11, K12

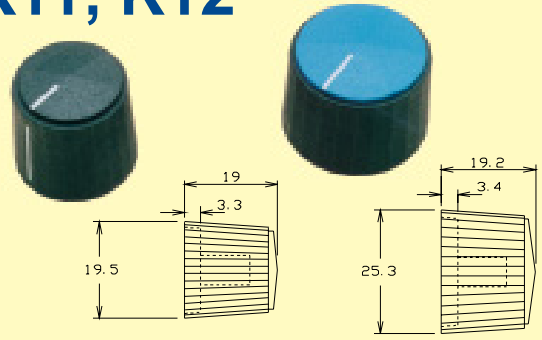

Both have separate push in caps. (8 colours).
Knob and cap can be plain or with a line.
Skirts used on K6 can be used on K12.
K11, K12 - Packed 200 / bag.
Caps packed 100 or 1000 / bag.

K13 A,B,C,D,E,F,G 'ENGINEERING KNOBS'

This range of knobs incorporate metal threads or threaded studs. The smallest versions with M4 studs have moulded in brass studs. Larger versions are made using ISO M4, M5, M6 or M8 steel nuts and bolts as the threaded element. Knobs can be supplied unassembled if required. Custom versions are easily made. Ask for our Data Sheet CL172915AP1/2.



See Page 8 for Shaft Options available.

K14,15,16



(mm)	Dia.	Height
K14	15	12.5
K15	20	13.0
K16	30	15.0

Aluminium clad plastic knobs with diamond turned finish. The finish is protected from tarnish / corrosion by a special treatment. Standard finish is bright aluminium. Marker line is optional.
K14, K15 - Packed 250 / carton.
K16 - Packed 100 / carton.

K15,16 P

(mm)	Dia.	Height
K15P	18.8	11.2
K16P	29.0	12.7

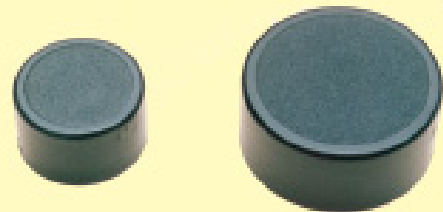

Plastic versions of K15 and K16. Both have a matt textured top.
K15P / K16P - Packed 250 / bag.

K17



Initially designed for electronic cosmetic equipment. The knob has a fine serrated edge, a matt non reflective finish, and a prominent marker line.

K17 - Packed 250 / bag.

C18

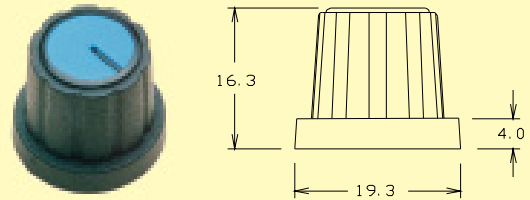

A low cost nylon knob, produced in all black version, or coloured cap version. Caps supplied pre-fitted, cannot be removed. Marker line has 4 possible locations. Available in push fix only.

Cap colours - Black, White, Grey, Green, Blue, Yellow or Red

C18 - Packed 500 or 1000 / bag.

C18/SKT

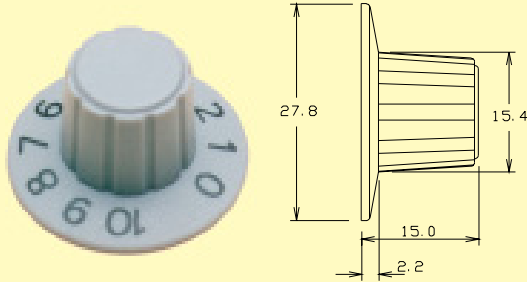

This model has knob and skirt in one piece. Skirt can have marker line or printed numbers 0-10.

Available in push fix only. Coloured caps not available.

C18/SKT - Packed 250 or 500 / bag.

KM12B, KM15B

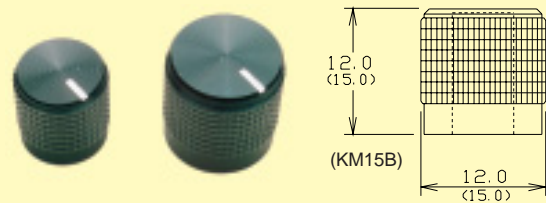

Knurled aluminium shells on plastic inners. Standard finish is black anodised to a very high standard.

Can have a printed marker dot or diamond cut marker line.

Custom versions possible subject to quantity. Packed in moulded trays

See Page 8 for Shaft Options available.

KxB Series

(x = 20,40,50)

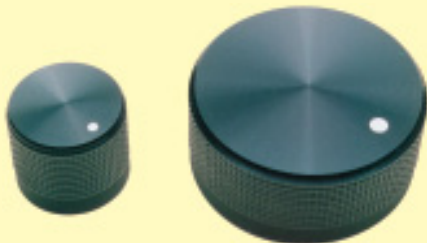

KMR Series

* Height can be varied to some extent.



(mm)	Dia.	Height
K20B	20	17
K40B	40	17
K50B	50	17
KMR15	15	16
KMR20	22	21
KMR25	25	18
KMR30	30	16
KMR35	35	19
KMR40D*	39	9
KMR40	40	19
KMR50	50	31

KB Series - Knurled aluminium shells on plastic inners. High quality black anodised finish is standard. Can have a printed marker dot or diamond cut marker line. Custom versions are possible subject to quantity. e.g. custom colour. Standard models are for 18T 6mm splined shaft.

KMR Series - Matt black with domed top. Marker dot or line. For 18T 6mm splined shaft.

Packed in moulded trays. Custom colours subject to viable quantity. * $\frac{1}{4}$ " D shaft is STD with finger dimple.

Dimensions in mm.

SLIDER POTENTIOMETER CONTROL KNOBS CS - SERIES

Nine different designs are produced. 3 types have option of 4mm. 6/8mm. shaft fitting. All knobs have matt non reflective finish to match our K9 - K12 series and C18. Standard colour - Black.

CS-1 : L 23mm. W 11mm. H 11mm.
CS-8 : L 17mm. W 10mm. H 8mm.



CS1 (for 6/8mm. shaft)
CS1A (for 4mm. shaft)
CS1B (for 4mm. shaft)
CS8 (for 6/8mm. shaft)

Length 20mm. Width 14mm. Height 13mm.



CS2 (for 6/8mm. shaft)
CS2A (for 4mm. shaft)
CS2B (for 4mm. shaft)

Length 29mm. Width 13mm. Height 7mm.



CS3 (for 6/8mm. shaft)

Length 12mm. Width 9mm. Height 9mm.



CS7A
CS7C
CS7A CS7C (for 4mm. shaft)

CS-9 : L 27mm. W 16mm. H 7mm.
CS-10 : L 27mm. W 13mm. H 8mm.



CS9 (for 6/8mm. shaft)
CS9A (for 4mm. shaft)
CS10 (for 6/8mm. shaft)

CS-11 : Diameter 8mm. Height 8mm.
CS-12 : L 12mm. W 12mm. H 10mm.



CS11
DESIGNED TO FIT SQUARE SHAFT OF
PUSH BUTTON SWITCHES AND 4mm.
OR 6mm. SLIDER SHAFTS
CS12
DESIGNED TO FIT 3.3mm. SHAFT OF
PUSH BUTTON SWITCHES

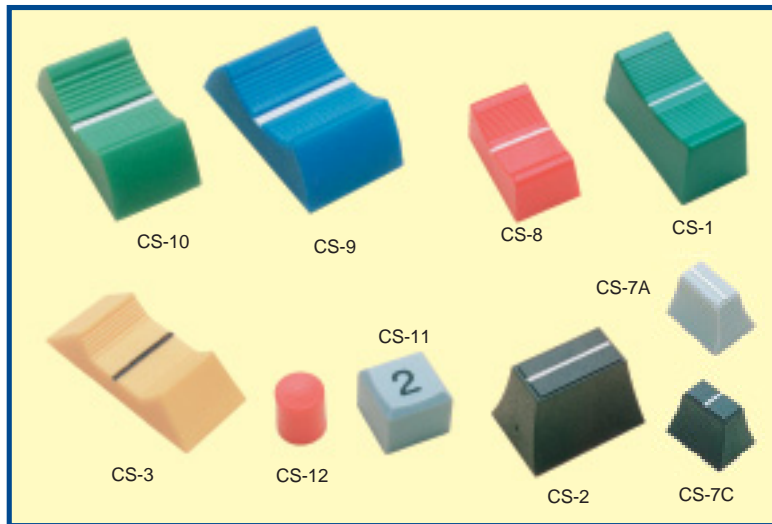

SHAFT DETAILS (TYPICAL)

4mm. Type Suffix 'A' STD. (or 'B' SPECIAL - Subject to viable QTY). 8mm. Type

6mm. Type

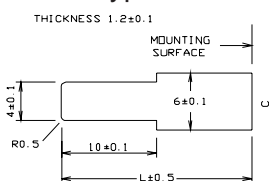

TYPE 'A'

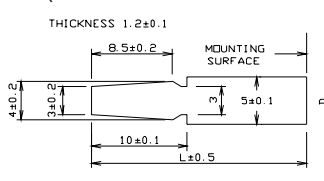

TYPE 'B'

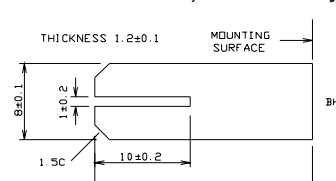

(Slider Pots shown in our Pots data).

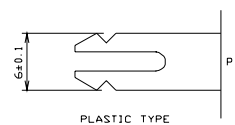

Note:- OTHER COLOURS OR SHAFT FITTINGS AVAILABLE SUBJECT TO ECONOMICAL QUANTITY.

CUSTOM MADE KNOBS AND BUTTONS

Where standard designs do not suit customers requirements, we can produce to your own designs. Sometimes we are able to modify existing tooling to avoid the need to make new full moulds.

Our two colour moulds are designed to be adaptable to produce custom designs (within certain size constraints), without the need to make a full mould, so custom designs can be achieved at moderate tooling cost - usually about 50% of the cost of a full mould. An 8 impression complete 2 colour knob mould will cost min. £20,000. By incorporating new designs into the existing moulds, the tooling cost can be reduced to around £7000 / £10,000. Therefore tooling of new models can be amortized more quickly, or may justify making new designs for smaller production runs. Actual tooling cost will depend on the complexity of the parts.

We have a number of semi custom parts which are available for use by any customers.

Generally full custom models are only available to the original user.

Semi custom parts are usually produced by incorporating one or more mould cavities into our own moulds used for standard products. Tooling costs for semi custom parts can be quite low. Ranging from £50 / £350 for a custom shaft fitting, to £750 / £3000 for a new cavity design. Actual cost will depend on the mould being adapted.

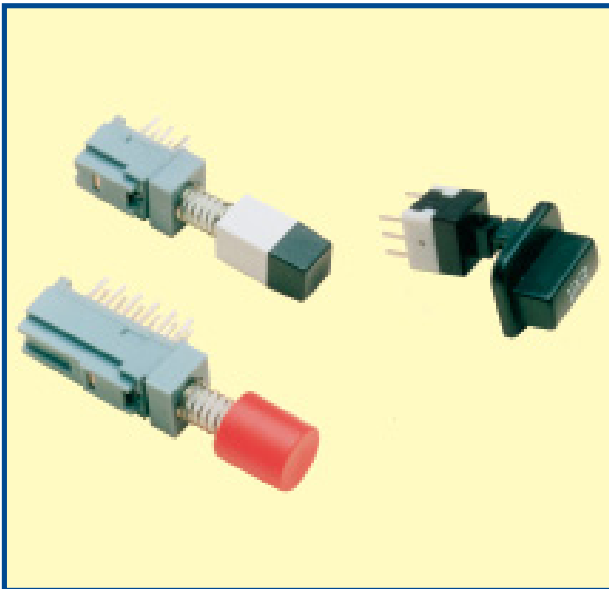

Injection moulding of 2 or more different kinds of plastic can give elegant solutions to many engineering design problems. In particular, the combination of hard plastic with rubber like materials is used more and more nowadays. Also the combination of opaque and clear materials is frequently used.

Knobs and buttons can be produced in almost any colour, from ABS, Nylon, Polypropylene, Acetal etc. They can be made to fit any size of shaft. New models are produced using our ISO9001/2 approved design and production facility.

Initial information needed for a custom design is as follows:

Design & Dimensions - Material - Colour - Annual quantity - Delivery date required.

Discuss these items with our Sales department.



ORDERING INFORMATION

STANDARD COLOURS

The colours shown below are for reference only and may not be identical to actual colours. If exact colour selection is required, we would be happy to provide samples for your evaluation.



In addition to the above, custom colours are available for single & multi colour moulded knobs. Call us to discuss your specific requirements.

Knob caps can be supplied plain, with a marker line (ML), with a marker dot (MD), or custom legend.

SHAFT SIZES

When specifying fixing options below, indicate shaft size and type, i.e.: screw fix (SF), push fix ('D'), splined (SPL), or collet.

SHAFT SIZE	3mm.	4mm.	4mm.	4mm.	6mm.	6mm.	6mm. U.S.A.	6mm.	6mm.	¼ inch.	¼ inch.	¼ inch.	¼ inch.	MARKER DOT & LINE OPTIONS
KNOB TYPE														
K1				•	•				•	•		•		S (std)
K2				•					•			•		S (std)
K3, K4									•	•		•		Z
K5					•				•			•		Z
K6, K6/SKT				•		∅			•			•		D SL N
K7				•	•	∅			•	•		•		Z
K8				•					•			•		S (std)
K85, K85M, K85MS ⁺⁺		•			•	•	•			•	•			Z (std)
K87MA, K87MB ⁺		∅			•	•	•			•				L Z
K9 [*]	•		•	•	•	•	•	•	•	•		•	•	L D Z
K10 [*]	•		•	•	•	•	•	•	•	•		•	•	L D Z
K11	•		•	•	•	•	•	•	•	•		•	•	L D Z
K12	•		•	•	•	•	•	•	•	•		•	•	L D Z
K13 REFER TO DATA														
K14				•	•		K14P		•	•		•	•	Z
K15, K15P				•	•				•	•		•	•	K15 - Z
K16, K16P				•	•	∅	K16P		•	•		•	•	K16 - Z
K17						∅			∅	∅		•		Z (std)
C18, C18/SKT					•	•	•			•				C18 - Z (std) C18-SKT SL N
KM12B, KM15B					•									
K20B, K40B, K50B					•									
KMR Series					•					KMR40D				
KEY					• = AVAILABLE - STD ∅ = ENQUIRE IF REQD.									L-Body Line D-Cap dot S-Skirt dot Z-Cap line SL-Skirt line N-Numbered

* For All Black model only - version with integral cap is available. NOT ALL PUSH FIX MODELS HAVE METAL SPRINGS.

+ Including 'R' 'Soft Touch' versions.

++ K85MS is under development.

Some models of our knobs are stocked by some Cliff distributors. Please enquire to our Sales Office.

© CLIFF 07/97

Cliff Electronic Components Limited

76 HOLMETHORPE AVENUE, HOLMETHORPE INDUSTRIAL ESTATE,
REDHILL, SURREY RH1 2PF. ENGLAND.

Tel : (01737) 771375 Fax : 01737-766012 E-MAIL : sales@cliffuk.co.uk

