



(2.54 mm) .100"

THROUGH-HOLE .025" SQ POST HEADER

Mates with:

SSW, SSQ, SSM, ESW, ESQ, BCS, BSW, CES, SLW, IDSD, IDSS, SMSD, SMSS

SPECIFICATIONS

For complete specifications see www.samtec.com?TSW or www.samtec.com?HTSW

Insulator Material:
TSW: Black Glass Filled Polyester
HTSW: Natural Liquid Crystal Polymer
Terminal Material:
Phosphor Bronze
Plating:
Au or Sn over 50µ" (1.27 µm) Ni
Operating Temp Range:
-55°C to +125°C with Gold
-55°C to +105°C with Tin
Voltage Rating:
550 VAC mated with SSW;
500 VAC mated with BCS or ESQ;
450 VAC -RA/-RE mated with BCS or SSM
400 VAC mated with CES
RoHS Compliant: Yes
Lead-Free Solderable:
HTSW: Yes
TSW: Wave Only

CURRENT RATING (PER PIN)						
TSW mated with						
ESW	SSW	SLW	SSQ	SSM	BCS	SNT
5.2 A	5.7 A	5.2 A	6.3 A	5.2 A	4.6 A	4.3 A
1 POSITION POWERED PER ROW						

TYPE STRIP	PIN CENTERS	NO. PINS PER ROW
TSW = Standard Strip	-1 = .100" (2.54 mm) Centers, All Positions Filled	-2 = .200" (5.08 mm) Centers, Every Other Position Filled
HTSW = Hi-Temp Strip		

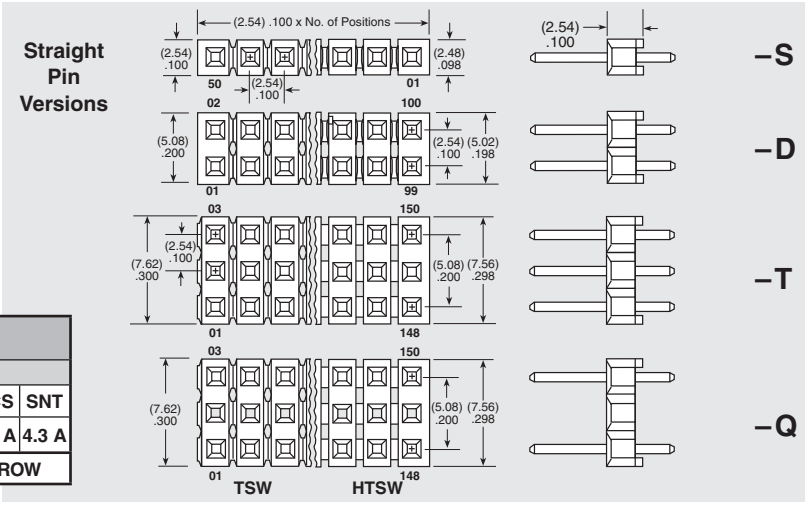

-S
-D
-T
-Q

01 thru 50
= .100" (2.54 mm) Center Version

RECOGNITIONS

For complete scope of recognitions see www.samtec.com/quality

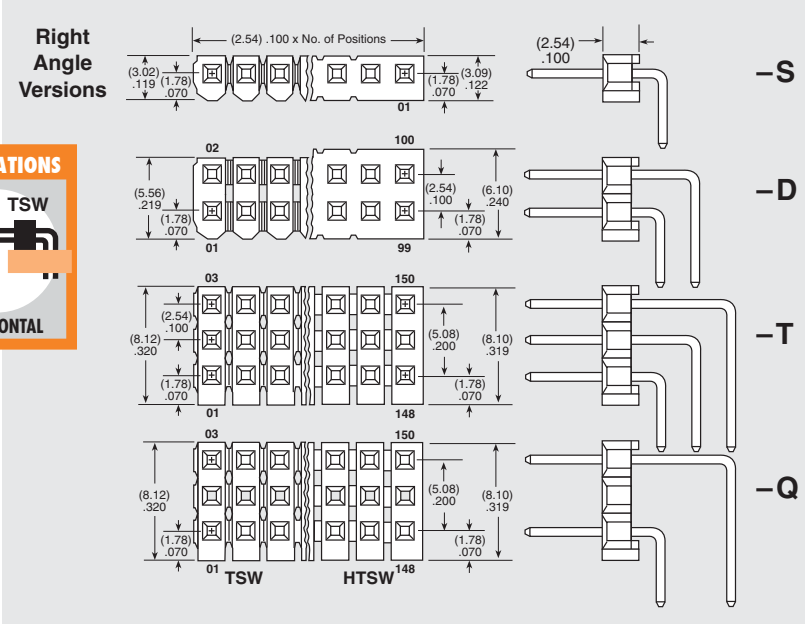
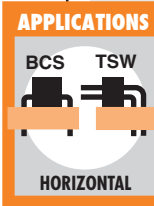

-S
-D
-T
-Q

02 thru 25
= .200" (5.08 mm) Center Version

ALSO AVAILABLE (MOQ Required)

- Other platings
- Contact Samtec.

Note: Some lengths, styles and options are non-standard, non-returnable.

TSW-109-10-F-D-RA

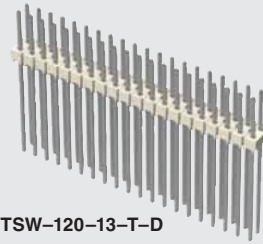
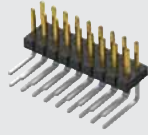

HTSW-120-13-T-D



TSW-114-16-G-S-RE

TSW-112-07-G-T

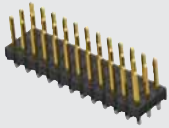

TSW, HTSW SERIES

LEAD STYLE

PLATING OPTION

ROW OPTION

OTHER OPTIONS

-F

= Gold flash on post, Matte Tin on tail

-L

= 10µ" (0.25 µm) Gold on post, Matte Tin on tail

-G

= 10µ" (0.25 µm) Gold on post, Gold flash on balance

-T

= Matte Tin

OTHER SOLUTIONS

- Elevated Right Angle option
- Shunts
- Contact Samtec

-S

= Single Row

-D

= Double Row

-T

= Triple Row

-Q

= Double Row (5.08 mm) .200" row space

-RA or -RE

= Right Angle

-NA

= Right Angle (using straight body for coplanar mating with SSW-RA series)

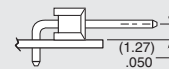

-LL

= Locking Lead

Two leads per strip crimped in opposite directions on or near centerline. See charts for available styles. N/A with single row 1 or 2 positions. Recommended hole size (1.02 mm ± 0.03 mm) .040" ± .001"

-LC

= Locking Clip (Styles -08 thru -13 & -22 only)

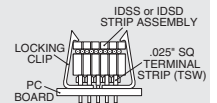

Requires 4 pin minimum (NA with -T, -Q, -RA or -RE)

-LA

= -RA Option with -LL Option

-“XXX”

= Polarized Position

Straight Pin Versions

(Specify "LEAD STYLE" from chart)

STYLE	A	B	C
* -05	(3.30) .130	(8.51) .335	(2.67) .105
* -06	(2.41) .095	(7.62) .300	(2.67) .105
* -07	(2.54) .100	(10.92) .430	
* -08	(5.08) .200	(13.46) .530	
-09	(10.16) .400	(18.54) .730	(5.84) .230
-10	(12.70) .500	(21.08) .830	
-11	(15.24) .600	(23.62) .930	
-12	(17.78) .700	(26.16) 1.030	
-13	(22.86) .900	(31.24) 1.230	
-14	(2.79) .110	(13.46) .530	(8.13) .320
* -15	(7.87) .310	(18.54) .730	(13.21) .520
* -16	(7.87) .310	(18.54) .730	(8.13) .320
* -17	(2.79) .110	(21.08) .830	(15.74) .620

* Available with -LL (Locking Lead) Option

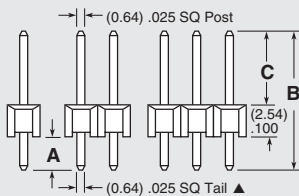

Specify -07 for best mate with IDXX Series IDC Cable

STYLE	A	B	C
* -18		(23.62) .930	(18.29) .720
* -19	(2.79) .110	(26.16) 1.030	(20.83) .820
* -20		(31.24) 1.230	(25.91) 1.020
* -21		(36.32) 1.430	(30.99) 1.220
* -22	(7.62) .300	(16.00) .630	(5.84) .230
* -23		(11.30) .445	
* -24	(2.92) .115	(12.15) .480	(6.73) .265
* -25	(5.33) .210	(16.00) .630	(8.13) .320
▲ -26	(3.20) .126	(11.58) .456	
-27	(25.40) 1.000	(33.78) 1.330	(5.84) .230
-28	(20.32) .800	(28.70) 1.130	
-29	(23.11) .910	(33.78) 1.330	(8.13) .320
-30	(18.03) .710	(28.70) 1.130	
+ -41	(0.89) .035	(9.27) .365	(5.84) .230
+ -42	(1.27) .050	(11.94) .470	(8.13) .320

+ Style -41 & -42 available with HTSW only.

▲ Except: Style -26 (0.46) .018 DIA Tail

Right Angle Versions

(Specify "LEAD STYLE" from chart and select -RA or -RE from other options)

-RA LEAD STYLE	SINGLE (-S)		DOUBLE (-D)	TRIPLE (-T & -Q)
	A	C	A	A
-08	(2.29) .090		(2.29) .090	(2.29) .090
-09	(7.37) .290		(7.37) .290	(7.37) .290
-10	(9.91) .390	(5.84) .230	(9.91) .390	(9.91) .390
-11	(12.45) .490		(12.45) .490	(12.45) .490
-12	(14.99) .590		(14.99) .590	(14.99) .590
-13	(20.07) .790		(20.07) .790	N/A
* -16	(5.08) .200	(8.13) .320	(5.08) .200	(5.08) .200
-21	(25.15) .990	(5.84) .230	N/A	N/A
* -22	(4.83) .190		(4.83) .190	(4.83) .190
* -25	(2.54) .100	(8.13) .320	(2.54) .100	(2.54) .100
-27	(22.61) .890	(5.84) .230	N/A	
-28	(17.53) .690		(17.53) .690	
-29	(20.32) .800	(8.13) .320	N/A	N/A
-30	(15.24) .600		(15.24) .600	

-RE LEAD STYLE	SINGLE A	C
-09	(4.83) .190	
-10	(7.37) .290	
-11	(9.91) .390	(5.84) .230
-12	(12.45) .490	
-13	(17.53) .690	
-16	(2.54) .100	(8.13) .320
-21	(22.61) .890	
-22	(2.29) .090	(5.84) .230
-27	(20.07) .790	
-28	(14.99) .590	

* Available with -LA (Locking Lead) Option

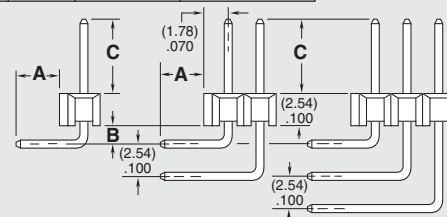

LEAD STYLE	B
-RA	(1.52) .060
-RE	(4.06) .160