

# AIRPAX®

## Snapak® Series Magnetic Circuit Protectors



*Introduction* • 55

*Handles* • 56

*Configurations* • 61

*Operating Characteristics* • 63

*Delay Curves* • 64

*Specifications* • 65

*Hardware* • 66

*Decision Tables* • 67

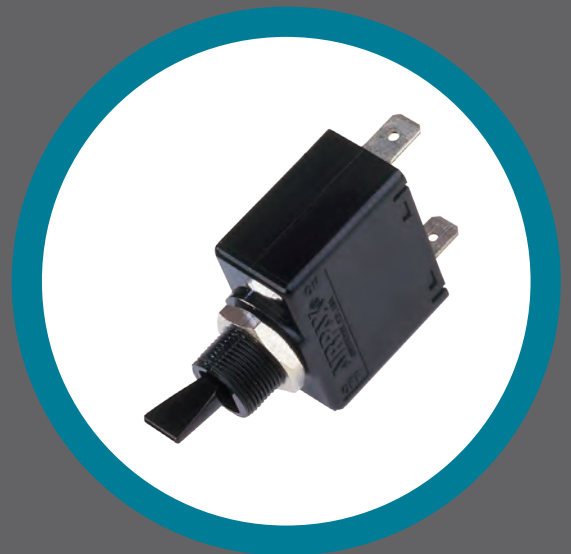



## AIRPAX® | T/R/PP/PR/CR/PP/CPR Series

### Hydraulic Magnetic Circuit Protectors (SNAPAK®)

## INTRODUCTION

The Airpax™ SNAPAK® series is a snap-acting hydraulic-magnetic circuit protector that combines power switching and accurate, reliable circuit protection in one aesthetically pleasing package. The SNAPAK® combines the functions of three separate components: power switch, fuse and fuse holder. To the OEM, this means that only one item has to be mounted instead of three. Less assembly is required, inventory is cut by two-thirds and greater panel density is obtainable with less clutter. In addition, the SNAPAK® can be operated at either DC or 50/60Hz, eliminating the need to specify, order and stock separate units. 400Hz units are also available.

To enhance front-panel aesthetics, SNAPAK® is offered with paddle and rocker handles in six attractive colors and push-pull and push-to-reset actuators. Also offered is a variety of optional mounting hardware. The push-pull version is supplied with a black button with a white indicating band.

Orientation of the button when marked with an amperage notation must be specified when using the fourth decision table. Push-to-reset is supplied with a contrasting color indicating shaft. In addition, SNAPAK® is offered in SPST and DPST configurations. The single pole satisfies most applications. The two-pole version is often used for extra safety in products that utilize high voltage or where current sensing and breaking of both sides of the line is required. Quick connect terminals are standard, UNC 8-32 or M4 screw terminals are available as additional termination options.

Since the SNAPAK® is snap-acting, it assures immediate opening and closing of the contacts. Its design also prevents operator “teasing” of the contacts and minimizes arcing. SNAPAK® circuit protectors are UL Recognized as supplementary protectors per UL STD. 1077, CSA Certified as supplementary protectors per CSA STD. C22.2 No. 235, VDE Approved as circuit breakers for equipment per STD. EN 60934, CCC Approved (customer must request product be manufactured in China) and CE Compliant. In addition, most versions are certified by UL to meet spacing requirements of IEC 950 for basic and functional insulation for front panel mounting.

Consult factory for details and exceptions. Typical applications include office appliances, electronic data processing, medical equipment, business machines, vending and amusement machines. Push-pull versions are particularly well suited for medical instrumentation, automotive production transfer lines and other applications where accidental turn off is unacceptable. For those applications which do not require circuit protection, SNAPAK® is offered in a power-switch-only configuration.

## TOGGLE ACTUATORS

The SNAPAK® is available with paddle handles in six attractive colors. Engineered for safe, sure operation, the paddle handles may be specified in blue, white, red, green, yellow or black.

### Mounting Details with Locking Ring

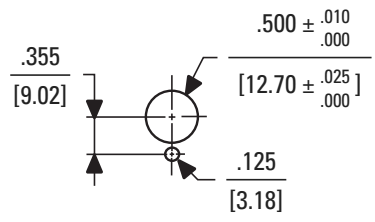

### without Locking Ring

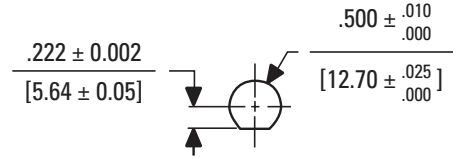

PANEL CUTOUT SHOWN ABOVE  
MAY BE MADE WITH GREENLEE  
RADIO CHASSIS PUNCH #733 x 1/2" DIA.

Note: Mounting Tolerance ± .005 [ .13] unless noted angles: ±5°. Dimensions in Brackets [ ] are millimeters.

### Single Pole, Toggle

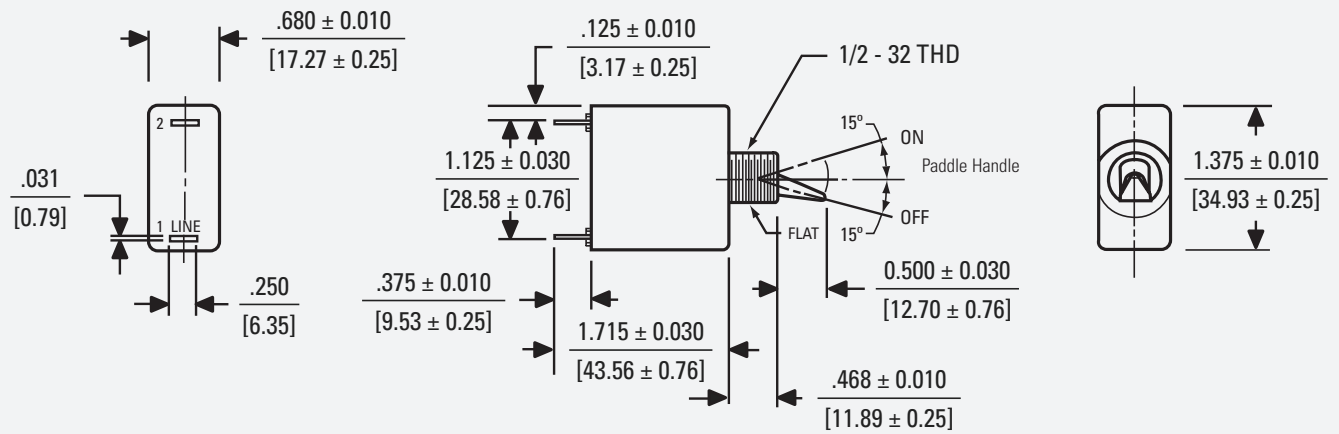

### Two Pole, Toggle

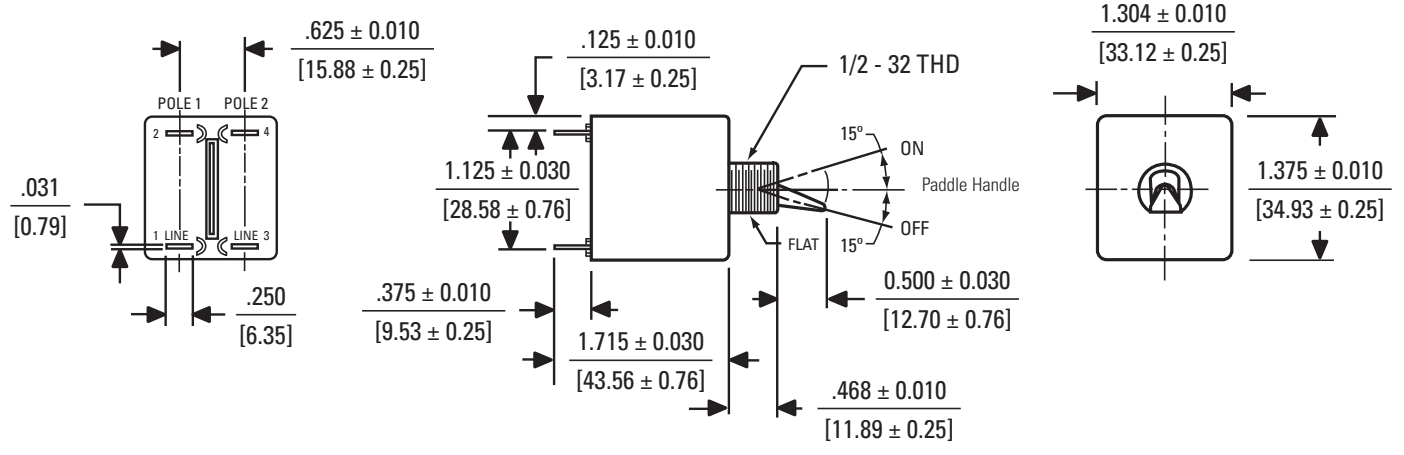

## ROCKER HANDLES WITH ILLUMINATION

SNAPAKs are offered in single and two pole rocker styles in a choice of black, white or gray body colors. Handle color in non-illuminated types may be black, red, white or orange. Neon or light emitting diode (LED) illumination may be specified with a variety of options.

SNAPAK® circuit protectors with a second pole are available in paddle handle, push-pull, push-to-reset and rocker handle versions.

Mounting Detail

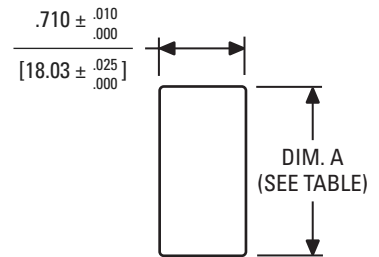

Rocker, Single Pole

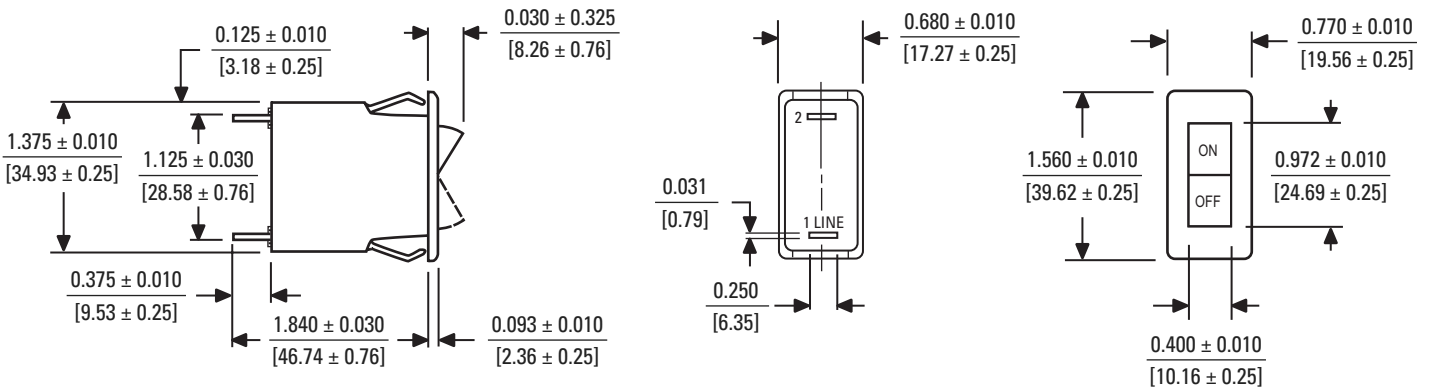

## HANDLE GUARDS

The SNAPAK® circuit protector is available with an optional handle guard as an integrated part of the snap-in mounting design. Available for rocker actuators, the guard helps in providing protection from accidental "turn-off." Please refer to the SNAPAK® Part Number Decision Tables; fourth decision.

Handle Guards, Single Pole

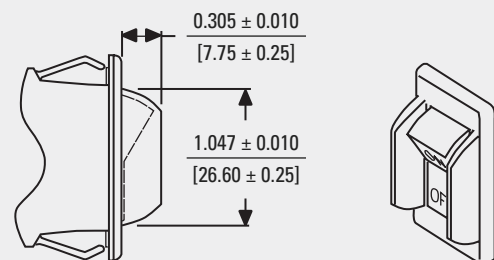

Handle Guards, Two Pole

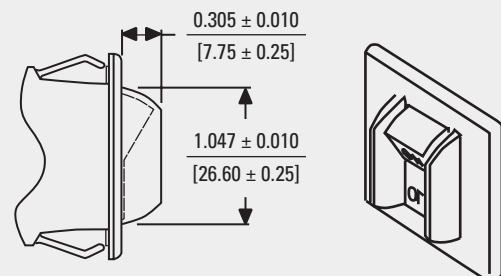

## FRONT SNAP-IN MOUNT (STD)

|  |                  |                  |                  |
|--|------------------|------------------|------------------|
| Panel Thickness                              | 0.125<br>[3.18]  | 0.093<br>[2.36]  | 0.062<br>[1.57]  |
| Dimension "A"                                | 1.460<br>[37.08] | 1.420<br>[36.07] | 1.385<br>[35.18] |
| <i>Note: Tolerance for Mtg. ± .005 (.13)</i> |                  |                  |                  |

Mounting Detail

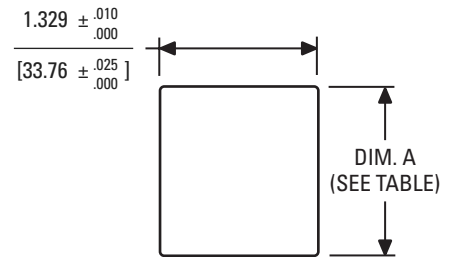

Rocker, Two Pole

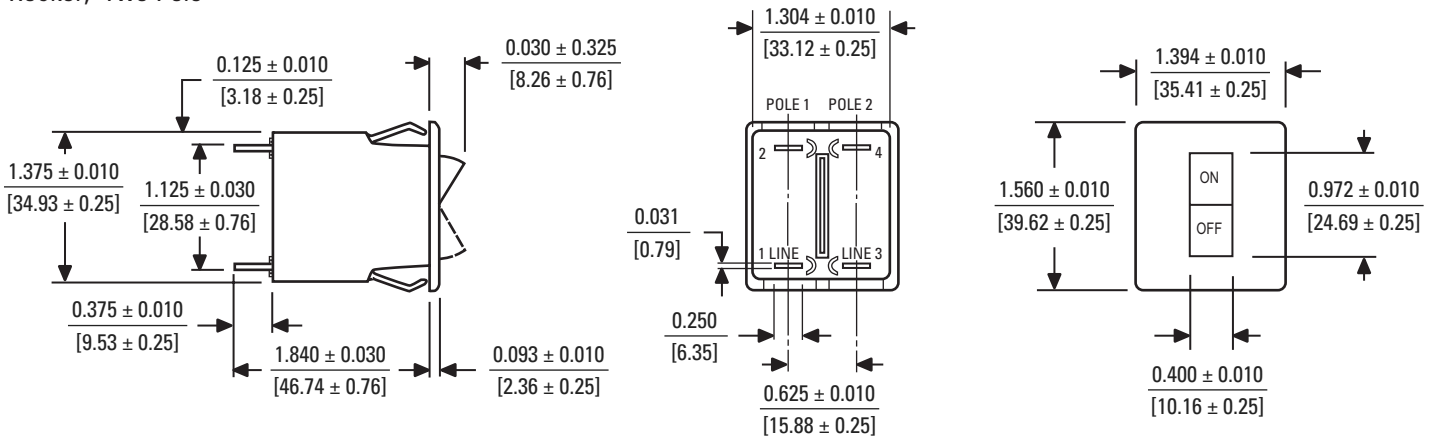

Illuminated Handle  
Single Pole

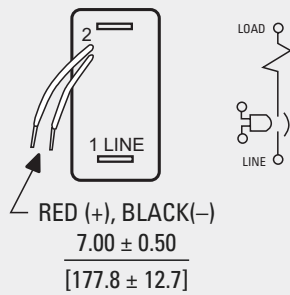

Two Pole

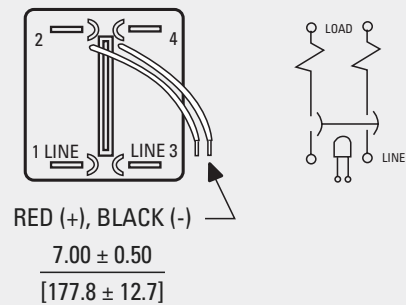

Note: Tolerance ± .005 [.13] unless noted angles: ±5°. Dimensions in Brackets [ ] are millimeters.

## PUSH-PULL, PUSH-TO-RESET ACTUATOR

SNAPAK® may also be ordered with Push-Pull, or Push-to-Reset actuator buttons. As an option, the button can be embossed with the current rating (Push-Pull option only).

Push-Pull, Single Pole

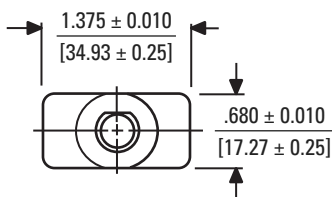
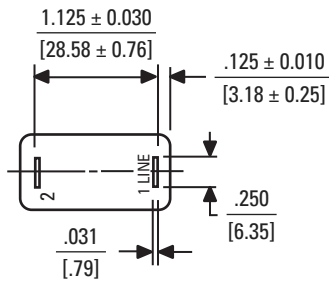
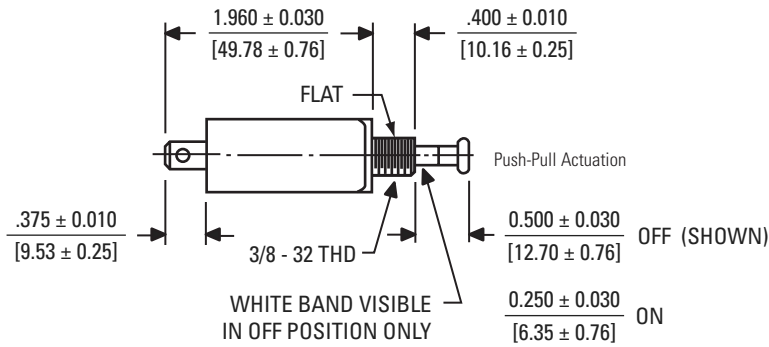

Mounting Detail  
(Single Pole and Two Pole)

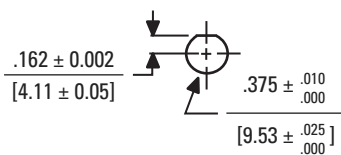

Note: Tolerance ± .005 [0.13] unless noted angles: ±5°. Dimensions in Brackets [ ] are millimeters.

Push-Pull, Two Pole

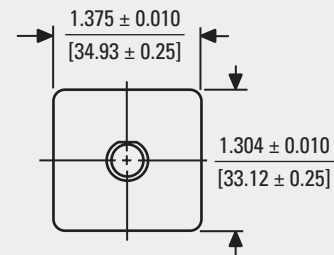
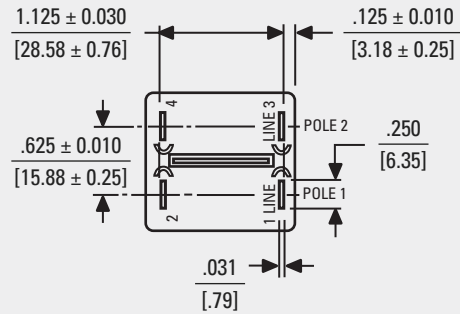
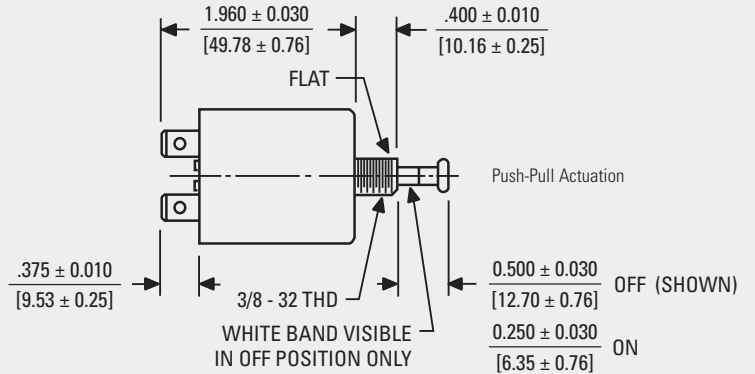

Push-to-Reset Actuation  
(Single and Two Pole)

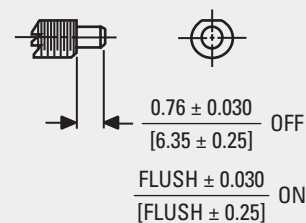

## SCREW TERMINALS

Available as straight screw terminals with UNC 8-32 and Metric M4 screw types, bus-type connect (flat) or upturned lugs (tabs), with UL, CSA and TÜV approvals available. Screw terminals are available for all handle options (rocker, toggle, push-pull, push-to-reset). Single pole only, series only, non-auxiliary switch configurations.

| DIMENSION "A" |                |               |
|---------------|----------------|---------------|
| Handle Style  | Screw Terminal | "A" Dimension |
| Toggle        | Straight       | 1.773 [45.03] |
| Push Button   | Straight       | 2.180 [55.37] |
| Rocker        | Straight       | 2.058 [52.27] |

Toggle

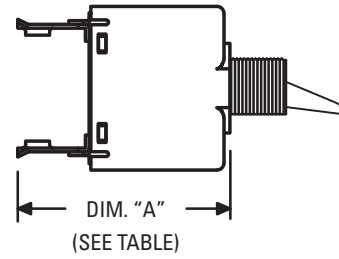

Push Button

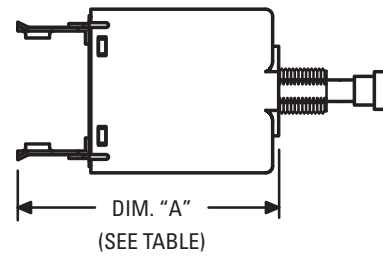

Rocker

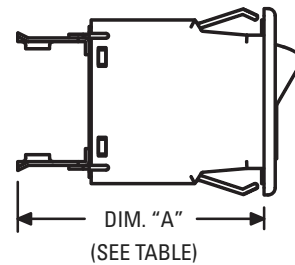

Straight

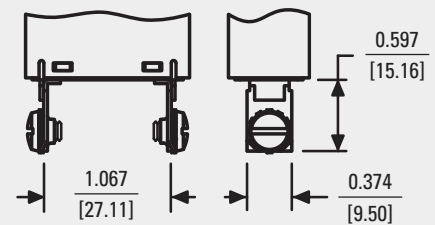

## CONFIGURATIONS

### Series Trip

The most popular configuration for magnetic protectors is the series trip where the sensing coil and the contacts are in series with the load being protected. In addition to providing conventional overcurrent protection, it is simultaneously used as an on-off switch.

### Shunt Trip

The shunt trip is designed for controlling two separate loads with one assembly. The control is established by providing overload protection for the critical load. When the current through this load becomes excessive and reaches the trip point, the protector will open and remove power from both loads simultaneously. The current rating of both loads must not exceed the maximum contact rating.

### Relay Trip

This permits the overload sensing coil to be placed in a circuit which is electrically isolated from the contacts. The coil may be actuated by sensors monitoring pressure, flow, temperature, speed, etc. Other typical applications include crowbar, interlock and emergency/rapid shutdown circuitry. Trip may be accomplished by voltage or current, which must be removed after trip.

Series Trip  
Single Pole

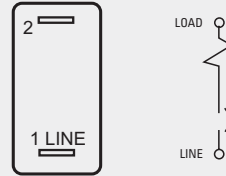

Two Pole

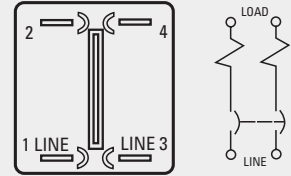

Shunt Trip  
Single Pole

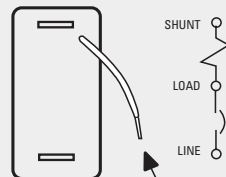

WHITE LEAD  
 $7.00 \pm 0.50$   
[177.8 ± 12.7]

Two Pole  
( 1 pole shunt)

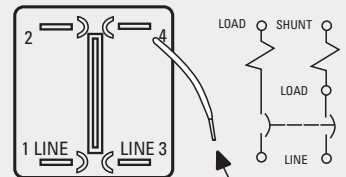

WHITE LEAD  
 $7.00 \pm 0.50$   
[177.8 ± 12.7]

Relay Trip (Note A)  
Single Pole

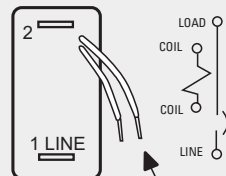

WHITE LEAD  
 $7.00 \pm 0.50$   
[177.8 ± 12.7]

Two Pole  
( 1 pole relay)

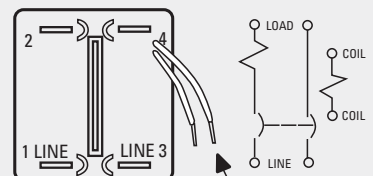

WHITE LEAD  
 $7.00 \pm 0.50$   
[177.8 ± 12.7]

Note A: Coil Ratings to 5 amperes maximum. Contact ratings are 7.5 amperes at 50 Vdc and 250 Vac; 15 amperes at 120 Vac; 32 Vdc.

Note: Tolerance ± .005 [.13] unless noted.  
Dimensions in Brackets [ ] are millimeters.



### Auxiliary Switch

This is furnished as an integral part of a series pole in single or, multi-pole assemblies. Isolated electrically from the protectors circuit, the switch works in unison with the power contacts and provides indication at a remote location of the protector's ON-OFF status.

### Voltage Trip

Sometimes called "dump circuits" or "panic trip circuits," these units make it possible to open main power contacts with lower power inputs from one or more sources. This configuration is becoming increasingly more important for sensitive circuitry and denser packaging in automation systems. Available in series, shunt or relay configurations.

### Power Switch

In the event that over-current protection is not desired, the coil mechanism can be deleted, providing an excellent low cost single or double-pole power switch. Maximum current rating is 20 amps.

### Auxiliary Switch (Note B) Single Pole



0.093 [2.36] 0.040 [1.02] DIA. HOLE (FOR SOLDER ATTACHMENT)

.100 to 20.0 amps,  
NON-VDE &  
NON-TÜV >20amps

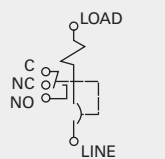

BREAKER SHOWN  
IN OFF POSITION

VDE, TÜV >20amps  
& U3 Construction

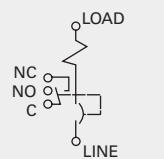

BREAKER SHOWN  
IN OFF POSITION

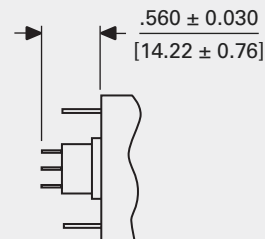

### Auxiliary Switch (Note B) Two Pole

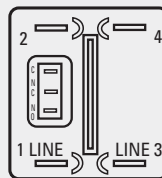

0.093 [2.36] 0.040 [1.02] DIA. HOLE (FOR SOLDER ATTACHMENT)

.100 to 20.0 amps,  
NON-VDE &  
NON-TÜV >20amps

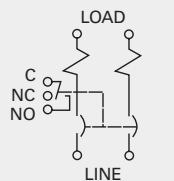

BREAKER SHOWN  
IN OFF POSITION

VDE, TÜV >20amps  
& U3 Construction

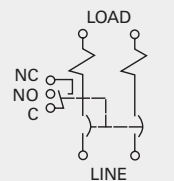

BREAKER SHOWN  
IN OFF POSITION

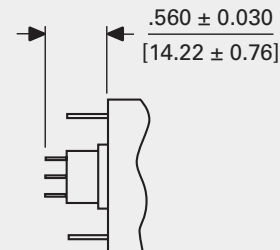

Note B: Switch is located in the left hand pole (viewed from terminal end).

## OPERATING CHARACTERISTICS

### Inrush Pulse Tolerance

Many circuit protector applications involve a transformer turn-on, an incandescent lamp load, or a capacitor charge from a DC source. Each of these applications has one common factor: a steep transient of very high current amplitude and short duration. This takes the form of a spike or a single pulse and is the cause of most nuisance tripping associated with magnetic circuit breakers.

SNAPAK® will withstand, without tripping, a single pulse of 8 milli-seconds duration (half sine wave configuration) and peak amplitude of 9 times its rating without the inertia wheel and 13 times its rating with an inertia wheel. (Not applicable to instant trip delays).

| MAXIMUM DCR AND IMPEDANCE |                         |                             |                          |
|---------------------------|-------------------------|-----------------------------|--------------------------|
| Current Ratings (Amps)    | T/R/PP/PR DC Resistance | T/R/PP/PR 50/60Hz Impedance | CR/CPP/CPR DC Resistance |
| .100                      | 175                     | 181                         | 274                      |
| .500                      | 6.34                    | 6.63                        | 9.77                     |
| 1.00                      | 1.63                    | 1.69                        | 2.31                     |
| 2.00                      | .400                    | .425                        | .465                     |
| 3.00                      | .175                    | .188                        | .261                     |
| 4.00                      | .103                    | .106                        | .156                     |
| 5.00                      | .076                    | .078                        | .091                     |
| 7.50                      | .038                    | .039                        | .053                     |
| 10.0                      | .026                    | .028                        | .023                     |
| 12.5                      | .020                    | .021                        | .020                     |
| 15.0                      | .013                    | .014                        | .010                     |
| 20.0                      | .010                    | .011                        | .008                     |
| 25.0                      |                         |                             | .004                     |
| 30.0                      |                         |                             | .003                     |

*DCR and Impedance is measured after 1 hour at 100% rated current using the Voltmeter-Ammeter Method.*

| PULSE TOLERANCE |                         |
|-----------------|-------------------------|
| Delay           | Pulse Tolerance         |
| 1, 2, 61, 62    | *9 Times Rated Current  |
| 3, 4, 61F, 62F  | *13 Times Rated Current |

*\* Units above 15 amps are derated to 8 and 12 times rated current*

| PERCENTAGE OF RATED CURRENT VS TRIP TIME IN SECONDS AT +25°C (VERTICAL MOUNT) |         |          |          |          |            |             |              |
|---|---------|----------|----------|----------|------------|-------------|--------------|
| Delay   | 100%    | 135%     | 150% *   | 200%     | 400%       | 600%        | 800%         |
| Instant   | No Trip | May Trip | .100 Max | .100 Max | .100 Max   | .100 Max    | .100 Max     |
| Fast  | No Trip | .3 to 7  | .2 to 5  | .1 to 2  | .03 to .50 | .015 to .30 | .010 to .150 |
| Slow  | No Trip | 3 to 70  | 2 to 40  | 1 to 15  | .10 to 4.0 | .015 to 2.0 | .010 to .800 |

*\* Minimum trip for all instantaneous and 400Hz units.*

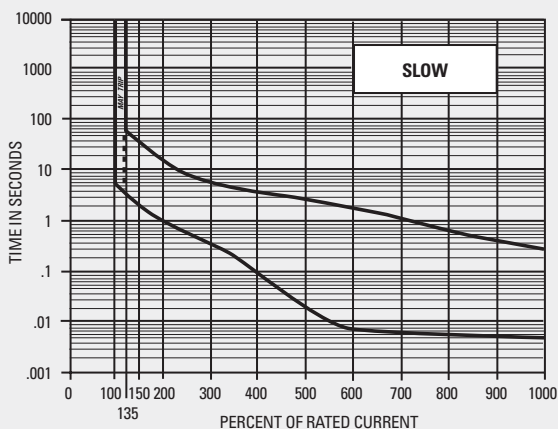
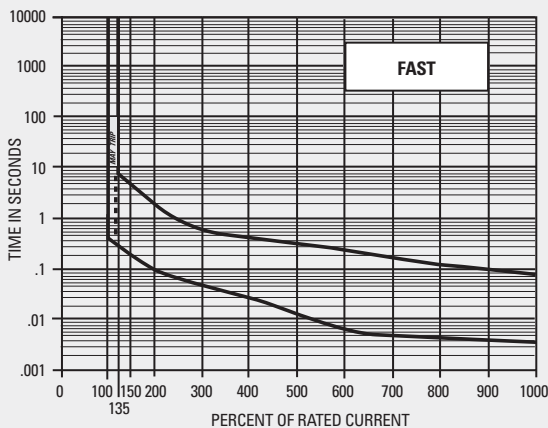
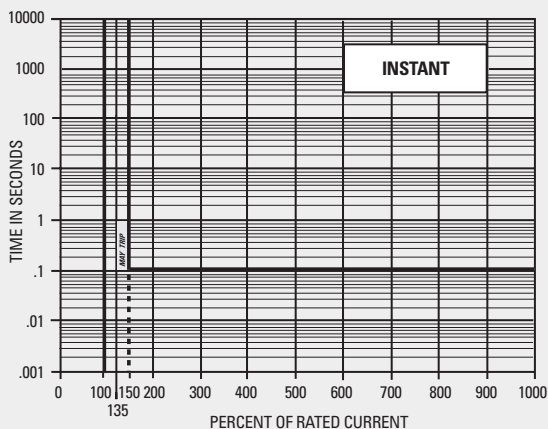

## DELAY CURVES & SPECIFICATIONS

### 400 Hz, DC, 50/60Hz Delay Curves (typ)

A choice of delays is offered for DC, 50/60Hz and 400Hz applications. Delays 0, 49, 59 and 69 provide fast-acting, instantaneous trip and are often used to protect sensitive electronic equipment (not recommended where known inrush exists). Delays 1, 41, 51 and 61 have a short delay for general purpose applications. Delays 2, 42, 52 and 62 are long enough to start certain types of motors and most transformer and capacitor loads.

### Trip Free

Will trip open on overload, even when forcibly held on. This prevents operator from damaging the circuit by holding handle in the ON position.

### Trip Indication

The operating handle moves forcibly and positively to the OFF position on overload.

### Ambient Operation

Operates normally in temperatures between  $-40^{\circ}\text{C}$  and  $+85^{\circ}\text{C}$ .

### Insulation Resistance

Not less than 100 megohms at 500Vdc.

### Dielectric Strength

Withstands 1500 volts, 60Hz for 60 seconds or 1800Vac for one second between all electrically isolated terminals.

### Endurance

Mechanical life in excess of 50,000 operations. In many applications, however, contact wear due to the electrical load determines unit life. At maximum electrical ratings, the SNAPAK® can perform 10,000 operations at rated current and voltage. Under UL 1077, the SNAPAK® can perform 50 operations at 150% of maximum rated current followed by 6,000 operations at maximum rated current. Under VDE 0642 (EN60934) the SNAPAK® can perform 6,000 electrical operations. After any endurance cycle, the breaker will calibrate and have working dielectric strength.

## AGENCY APPROVALS (T/P/PP/PR SUPPLEMENTARY PROTECTORS)

| Voltage (Volts), Frequency (hz), Phase, Min Poles, TC, OL |                |       |            |    |    | Current (Amps) |         | Short Circuit Current Rating (Amps) |      | Notes          |
|---|----------------|-------|------------|----|----|----------------|---------|-------------------------------------|------|----------------|
| Voltage   | Frequency (Hz) | Phase | Min. Poles | TC | OL | UL/CSA         | VDE     | UL 1077 & CSA                       | VDE  | Notes          |
| 32  | DC             | -     | 1          | 1  | 0  | .10-30(3)      | .10-20  | U1, 1000                            | 500  |                |
| 38  | DC             | -     | 1          | 1  | 0  | .10-15         | -       | U2, 1000 / U1, 1000                 | -    | PR only        |
| 65  | DC             | -     | 1          | 1  | 0  | .10-7.5        | -       | U2, 500 / U1, 500                   | -    |                |
| 65  | DC             | -     | 2          | 1  | 0  | .10-15         | -       | U1, 1000                            | -    |                |
| 65  | DC             | -     | 2          | 1  | 0  | .10-20         | .10-20  | U2, 500 / U1, 500                   | 500  |                |
| 65(2)   | DC             | -     | 1          | 1  | 0  | .10-30         | .10-30  | U2, 120                             | 120  | R, PP, PR only |
| 65(2)   | DC             | -     | 2 only     | 1  | 0  | .10-25         | -       | U1, 100                             | -    | R only         |
| 65(2)   | DC             | -     | 2          | 1  | 0  | .10-25         | -       | U2, 500                             | -    | R only         |
| 125   | 50/60          | 1     | 1          | 1  | 0  | .10-20         | 7.6-20  | U1, 1000                            | 500  |                |
| 125   | 50/60          | 1     | 1          | 1  | 0  | .10-30(3)      | -       | U1, 1000                            | -    | T only         |
| 125(2)  | 50/60          | 1     | 1          | 1  | 0  | .10-30         | -       | U2, 1000                            | -    | R, PP, PR only |
| 125(2)  | 50/60          | 1     | 1          | 1  | 1  | .10-30         | 20.1-30 | U3, 300(1)                          | 500  | R, PP, PR only |
| 120/240   | 50/60          | 1     | 2          | 2  | 0  | .10-20(3)      | -       | U2, 1000                            | -    |                |
| 120/240   | 50/60          | 1     | 2          | 2  | 0  | .10-30(3)      | -       | U1, 650                             | -    |                |
| 125/250   | 50/60          | 1     | 2          | 2  | 0  | .10-20         | -       | U1, 1000                            | -    |                |
| 250   | 50/60          | 1     | 1          | 2  | 0  | .10-20         | .1-7.5  | U1, 500                             | 500  |                |
| 250   | 50/60          | 1     | 1          | 1  | 0  | .10-7.5        | -       | C1, 1000(4)                         | -    |                |
| 250   | 50/60          | 1     | 2          | 2  | 0  | .10-20         | .10-20  | U1, 1000                            | 500  |                |
| 250(2)  | 50/60          | 1     | 2          | 1  | 1  | .10-30         | -       | U3, 300                             | -    | R only         |
| 125   | 400            | 1     | 1          | 2  | 0  | .10-20         | -       | U1, 1000                            | -    |                |
| 125/250   | 400            | 1     | 2          | 2  | 0  | .10-20         | -       | U1, 1000                            | -    |                |
| 250   | 400            | 1     | 2          | 2  | 0  | .10-20         | -       | U1, 1000                            | -    |                |
| 250   | 400            | 1     | 1          | 2  | 0  | .10-7.5        | -       | U1, 1000                            | -    |                |
| CR/CPP/CPR COMMUNICATIONS EQUIPMENT CIRCUIT BREAKERS      |                |       |            |    |    |                |         |                                     |      |                |
| 65  | DC             | -     | 1 only     | -  | -  | .10-30         | .10-30  | 1000                                | 1000 |                |
| 80  | DC             | -     | 1 only     | -  | -  | .10-30         | .10-30  | 600                                 | 600  |                |

(1) Non-standard construction. "Fit For Further Use" approval; (2) Non-snap action design; (3) No auxiliary switch available above 20A; (4) With 30A max. series fuse

### General notes:

All supplementary protectors are of the overcurrent (OC) type  
 The family of protectors has been evaluated for end use application for use group (UG) A  
 The terminals (FW) are suitable for factory wiring only (O)  
 The maximum voltage ratings for which the protectors have been tested are shown in the chart  
 The current is the amperage range that the protectors have been tested  
 The tripping current (TC) for the protectors is either "1" (in the range of 125% to 135% of ampere rating) or "2" (more than 135% of ampere rating)  
 The overload rating (OL) – designates whether the protector has been tested for general use or motor starting applications.  
 0 – tested at 1.5 times amp rating for general use  
 1 – tested at 6 times AC rating or 10 times DC rating for motor starting  
 The short circuit current rating (SC) – The short circuit rating in amperes following a letter and number designating the test conditions and any calibration following the short circuit test is defined below:

| AUXILIARY SWITCH RATING |   |         |        |
|-------------------------|---|---------|--------|
| <b>Silver</b>           |   |         |        |
| 3.0 amps                | @ | 120 VAC | —      |
| 1.5 amps                | @ | —       | 32 VDC |
| <b>Gold</b>             |   |         |        |
| .100 amps               | @ | 32 VAC  | 32VDC  |

| APPROXIMATE WEIGHT PER POLE |        |       |
|-----------------------------|--------|-------|
|                             | Ounces | Grams |
| Rocker Configuration        | 0.9    | 25    |
| Toggle, PP, PR              | 1.2    | 32    |

C – Indicates short circuit test was conducted with series overcurrent protection  
 U – Indicates short circuit test was conducted without series overcurrent protection  
 1 – Indicates a recalibration was not conducted as part of the short circuit testing  
 2 – Indicates a recalibration was performed as part of the short circuit testing  
 3 – Indicates recalibration was performed along with the dielectric and voltage withstand for "Suitable for Further Use" rating

### Short Circuit Interrupting Capacity

1000 amperes maximum for UL and CSA, 500 amperes maximum for VDE. Consult factory for details.

### Handle and Body Material

The handle and upper body material is polycarbonate and the lower body is PET.

### Chemical Resistance

Handle and case may be cleaned with detergents or alcohols and should be restricted to outside surfaces only. Organic solvents are not recommended. Special attention should be given when solvents are used to remove excess flux from terminals. No oils or lubricants should be introduced into handle openings or onto bushing threads.

IEC, UL, CSA, SEV, VDE, CCC, CE, TÜV

Recognized by UL to STD-1077 and UL certified to spacing requirements of IEC 950 for basic and functional insulation for front panel mounting. Certified by CSA, file number LR26229 as recognized supplementary protectors, SEV approved, CCC approved, TÜV approved (including screw terminals) and VDE approved to VDE 0642. VDE approval of unmarked rocker handle option for appliance disconnect requires status of protectors to be indicated on the panel. Only VDE approved part numbers will be marked CE compliant. See shaded areas of part number decision tables for approved configurations and/or consult factory for exceptions and limitations.

### Shock

Withstands 75G without tripping while carrying full rated current per MIL-STD-202, Method 213, Test Condition I. Instant trip breakers are tested at 80% of rated current.

### Vibration

Time delayed units withstand 10G without tripping while carrying full rated current per MIL-STD-202, Method 204, Test Condition A. Instant trip breakers are tested at 80% of rated current.

### UL 489A Listed

The CR, CPP and CPR are dimensionally the same as the popular R, PP and PR Snapack products, but provide UL listing to UL489A for Communications Equipment. Available only in single pole with DC trip time delays for series or series with silver auxiliary switch configurations. As a circuit breaker, the CR, CPP or CPR provides communication equipment manufacturers with a UL listed circuit breaker in an extremely compact package that meets the stringent environmental requirements of today's marketplace. This makes the CR, CPP and CPR ideal for switching, transmission and wireless applications.

Paddle Handle Hardware



- A

Vertical Mount

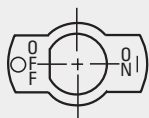

- B

Horizontal Mount

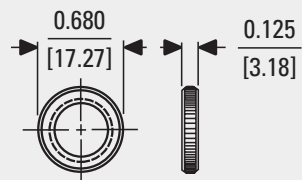

- 10 & -11

Knurled Nut

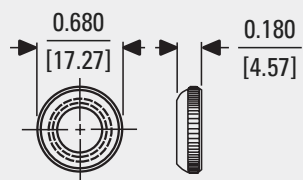

- 20 & -21

Panel Dress Nut

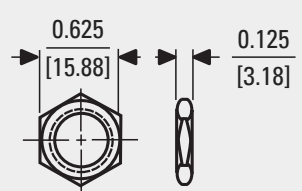

- 31

Hex Nut

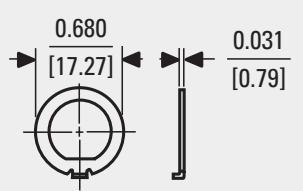

- L

Locking Ring (Toggle)

Push-Pull & Push-to-Reset Hardware

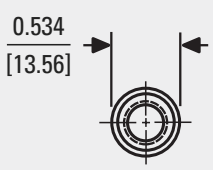

3/8 - 32 Panel Nut  
Bright Nickel

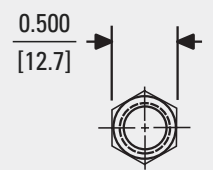
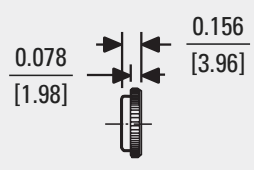

3/8 - 32 Hex Nut  
Bright Nickel

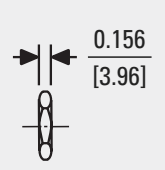

Note: Tolerance ± .010 [.25] unless noted. Dimensions in brackets [ ] are millimeters.

**HARDWARE**

**Indicator Plates**

SNAPAK® toggle handle circuit protectors may be specified with indicator plates for either vertical or horizontal mounting. The "ON-OFF/O-I" plate is standard.

Note 1:

To allow for installation clearances, the minimum recommended distances between centers of panel openings should be:

| RECOMMENDED CENTER DISTANCES FOR PANEL OPENINGS |                       |
|---|-----------------------|
| Breaker Type                                    | Distance, inches [mm] |
| T11   | 0.750 [19.05]         |
| T21   | 1.375 [34.93]         |
| PP11 & PR11                                     | 0.750 [19.05]         |
| PP21 & PR21                                     | 1.375 [34.93]         |
| R11   | 0.805 [20.45]         |
| R21   | 1.429 [36.30]         |

Note 2: Torque on mounting hardware is not to exceed 25 inch-pounds for 1/2 inch bushings or 15 inch-pounds for 3/8 inch bushings.

**Mounting Nuts (Toggle)**

A choice of knurled, dress and hex nuts are available. All three are available in bright nickel. The knurled and dress nuts are also available in a matte black finish. Every SNAPAK® comes with a hex nut, but you may order the front panel nuts which will best enhance your design.

**Miscellaneous Hardware**

SNAPAK® circuit protectors with 1/2-32 thread may also be equipped with optional locking rings to prevent rotation of the unit after it is installed.

**3/8 - 32 Hex Nut and Panel Nuts**

The hardware will be supplied with each Push-Pull (PP) and Push-to-Reset (PR).

**3/8 - 32 Panel Nut**

This nut when reversed will provide alignment in .437 (11.1) and .468 (11.88) diameter round panel holes.

## HOW TO ORDER

The ordering code for the SNAPAK® circuit protectors may be determined by following the steps in the decision tables shown here.

The coding given permits a self-assigning part number, with certain limitations (due to the adaptability of magnetic protectors to complex circuits), requires a factory-assigned part number.

The example shown is the code for a paddle handle, single pole (UL construction), series circuit protector designed for operation of a 50/60Hz/DC circuit. A slow time delay and rating of 5 amperes has been indicated. Handle color is black, and a bright nickel knurled nut, vertical mount (ON-OFF) indicator plate and locking ring are to be supplied.

To determine the ordering code for your particular SNAPAK® unit, simply follow the steps shown, then fill in the letters and/or numbers in the boxes. Space is available on the circuit breaker label for your part number (up to 12 digits). You may then use your own part number to place an order or as a reference for further questions you may have. This option does require a factory assigned part number for traceability to your drawing or internal part number.

| 1 First Decision  |               |                 |                |           |                                  |  |
|---|---------------|-----------------|----------------|-----------|----------------------------------|--|
| Handle  | Poles         | Configurations* |                | Terminals |                                  |  |
| <b>T</b>  | Paddle Handle | <b>1</b>        | Single Pole †  | <b>0</b>  | Switch Only (Note E)             | <b>S</b> Screw Terminals, Single pole (-1) and series only<br><br>(5th decision, group V - screw terminal option is required when 1st decision "S" is specified) |
| <b>PP</b>   | Push-Pull     | <b>4</b>        | Single Pole †† | <b>1</b>  | Series Circuit Protector         |  |
| <b>PR</b>   | Push-To-Reset | <b>2</b>        | Two Pole †     | <b>3</b>  | Shunt Circuit Protector          |  |
| <b>R</b>  | Rocker        | <b>5</b>        | Two Pole ††    | <b>4</b>  | Relay Circuit Protector ††††     |  |
| <b>CR</b>   | Rocker        | **              |                | <b>5</b>  | Series w/ Silver Aux. Switch ††† |  |
| <b>CPP</b>  | Push-Pull     | **              |                | <b>6</b>  | Series w/ Gold Aux. Switch †††   |  |
| <b>CPR</b>  | Push to Reset | **              |                | <b>9</b>  | Mixed Construction (2 Pole Only) |  |
| † UL & CSA Construction<br>†† Non UL & CSA Construction<br>††† Auxiliary Switch is located in the left hand pole (viewed from terminal end)<br>†††† Does not meet spacings for many IEC /VDE equipment specs. Consult factory for additional information.<br>* Multi-pole units with mixed construction, poles numbered left to right when viewed from terminal end. Shunt or relay construction available in pole 2 only, other pole must be a series or switch only construction.<br>**UL 489A listed, available in 1 pole series or series w/silver aux. switch. DC delay only |               |                 |                |           |                                  |  |

**T11 - 2- 5.00A - 01-11AL- V**

| 2 Second Decision  |                                   |
|--|-----------------------------------|
| Frequency & Delay  |                                   |
| <b>-0</b>  | Instant DC-50/60 Hz               |
| <b>-1</b>  | Fast DC-50/60 Hz                  |
| <b>-2</b>  | Slow DC-50/60 Hz                  |
| <b>-3</b>  | Fast w/ Inertia Wheel DC-50/60 Hz |
| <b>-4</b>  | Slow w/ Inertia Wheel DC-50/60 Hz |
| <b>-41*</b>  | Fast 400 Hz***                    |
| <b>-42*</b>  | Slow 400 Hz*                      |
| <b>-49*</b>  | Instant 400 Hz                    |
| <b>-51</b>   | Fast DC+                          |
| <b>-52</b>   | Slow DC+                          |
| <b>-59</b>   | Instant DC+                       |
| <b>-61</b>   | Fast 50/60 Hz*                    |
| <b>-62</b>   | Slow 50/60 Hz*                    |
| <b>-69</b>   | Instant 50/60 Hz                  |
| <b>-S</b>  | Switch Pole or Special Delay      |
| * 20 amps max for 400Hz  |                                   |
| **For addition of Inertia Delay an "F" may be added to delay 41, 42, 51, 52, 61, 62 only |                                   |
| †CR, CPP, CPR only available in these delays   |                                   |

| 3 Third Decision  |                        |
|---|------------------------|
| Rated Current   |                        |
| Circuit Breaker Construction  |                        |
| <b>Use three numbers to print required current value between .100 amps minimum and 30.0 amps maximum.</b> |                        |
| For example, use:<br>.100 or 2.00 or 10.0   |                        |
| Switch Only Construction  |                        |
| <b>-SW</b>  | Maintained SPST & DPST |
| Note: 20.0 amps max for 400 Hz units.   |                        |

Notes:

- A A neon bulb is provided when specified for 120Vac and 250Vac operation. For operation at 120Vac a 33,000 ohm, 1/2 watt external resistor is required. At 250Vac a 100,000 ohm, 1 watt external resistor is required.
- B An LED with 750 ft. L @ 20mA is provided in the center of the handle. Maximum power dissipation @ 25°C is 135mW. Continuous forward current is 20mA. Forward voltage, typical, is 1.6v at 20mA. Reverse current, typical, is 100mA @ 3.0 volts. An external resistor may be required to limit current to these values.
- C When ordering Paddle Handles, you may choose one item from each hardware group to add to 5th decision if such items are desired. For example, "-11ALCA" would indicate a bright nickel knurled nut, plus a vertical mount indicator, plus a locking ring, plus #8-32 screw terminal, straight with tabs.
- D All units except Rocker units will have (1) hex nut installed as standard hardware for the back of a panel. The choices in the fifth decision table are intended for the front or visible side of the panel and are offered for Paddle Handle configuration only. Push-Pull and Push-to-Reset configurations include one (1) panel nut and one (1) hex nut as standard hardware.
- E Switch only — no current overload protection provided.
- F CCC Approval - If CCC is required on this product, please inform Sensata to have this product manufactured in our China facility

#### 4 Fourth Decision

|   |       |          |                       |
|---|-------|----------|-----------------------|
| Rocker  |       |          |                       |
| Step 1: Choose Letter For Body Color                    |       |          |                       |
| <b>B</b>  | Black | <b>R</b> | Black w/ Handle guard |
| <b>G</b>  | Gray  | <b>S</b> | Gray w/ Handle guard  |
| <b>W</b>  | White | <b>T</b> | White w/ Handle guard |
| Example: "W..."<br>For White Rocker Body (Rocker Style) |       |          |                       |

|   |   |                 |  |
|---|---|-----------------|--|
| Step 2: Choose Handle Combinations                                    |   |                 |  |
| Without Illumination Basic Handle Color (w/o Markings)                |   |                 |  |
| <b>01</b>   | Black   | Example: "-W06" |  |
| <b>02</b>   | Red   |                 |  |
| <b>06</b>   | White   |                 |  |
| <b>07</b>   | Orange  |                 |  |
| With Illumination Basic Handle Color & Light Choice (w/o Markings)    |   |                 |  |
| <b>101</b>  | Clear w/Neon (Note A)                             |                 |  |
| <b>102</b>  | Clear w/Green Glow Neon (Note A)                  |                 |  |
| <b>103</b>  | Clear w/Red LED (Note A)                          |                 |  |
| <b>104</b>  | Clear w/4-8 Vdc Red LED                           |                 |  |
| <b>105</b>  | Clear w/8-16 Vdc Red LED                          |                 |  |
| <b>107</b>  | Clear w/Green LED (Note B)                        |                 |  |
| <b>108</b>  | Clear w/4-8 Vdc Green LED                         |                 |  |
| <b>109</b>  | Clear w/8-16 Vdc Green LED                        |                 |  |
| <b>121</b>  | Transparent Red w/Neon (Note A)                   |                 |  |
| <b>123</b>  | Transparent Red w/Red LED (Note B)                |                 |  |
| <b>124</b>  | Transparent Red w/Red LED 4-8 Vdc                 |                 |  |
| <b>125</b>  | Transparent Red w/Red LED 8-16 Vdc                |                 |  |
| <b>161</b>  | Translucent White w/Neon (Note A)                 |                 |  |
| <b>162</b>  | Translucent White w/ Green Glow Neon (Note A)     |                 |  |
| <b>171</b>  | Transparent Amber w/Neon (Note A)                 |                 |  |
| <b>181</b>  | Transparent Smoke Gray w/Neon (Note A)            |                 |  |
| <b>182</b>  | Transparent Smoke Gray w/Green Glow Neon (Note A) |                 |  |
| <b>183</b>  | Transparent Smoke Gray w/Red LED (Note B)         |                 |  |
| <b>184</b>  | Transparent Smoke Gray w/4-8 Vdc Red LED          |                 |  |
| <b>185</b>  | Transparent Smoke Gray w/8-16 Vdc Red LED         |                 |  |
| <b>187</b>  | Transparent Smoke Gray w/Green LED (Note B)       |                 |  |
| <b>188</b>  | Transparent Smoke Gray w/4-8 Vdc Green LED        |                 |  |
| <b>189</b>  | Transparent Smoke Gray w/8-16 Vdc Green LED       |                 |  |
| Example: "-W124"  |   |                 |  |
| If you prefer NO markings, then your handle decision is now complete. |   |                 |  |

#### Step 3: Choose Handle Markings

Marked For Vertical Mount-After choice of 3 digit number in step 2 above.



Add "**CV**" for Combined markings.



Add "**EV**" for English markings.  
Example: "-W124EV"



Add "**IV**" for Intl. markings.

Marked For Horizontal Mount-After choice of 3 digit number in step 2 above.



Add "**CH**" for Combined markings.



Add "**EH**" for English markings.  
Example "-W06EH"



Add "**IH**" for International markings.

If you have chosen a handle from this table, your 4th Decision and your catalog part number are now complete (except if you require "-S" screw terminal option from the 5th Decision Table.)

#### Paddle (T) Handle Color

|            |        |
|------------|--------|
| <b>-01</b> | Black  |
| <b>-02</b> | Red    |
| <b>-03</b> | Yellow |
| <b>-04</b> | Green  |
| <b>-05</b> | Blue   |
| <b>-06</b> | White  |

If you have chosen a handle from this table, your 4th Decision is now complete except for hardware options in 5th Decision Table.

#### Push-Pull (PP, CPP and CPR)

|            |  |  |      |
|------------|--|--|------|
| <b>-XX</b> | No Button Markings desired (not available for CPP & CPR) |  |      |
| <b>-OA</b> |  | Marked Buttons Available For These Amperages |      |
| <b>-OB</b> |  | 0.1  | 1    |
|            |  | .25  | 2.5  |
| <b>-OC</b> |  | 0.5  | 5    |
|            |  | .75  | 7.5  |
|            |  |  | 15   |
|            |  |  | 17.5 |
|            |  |  | 20   |

If you have chosen a handle from this table, your 4th Decision & your catalog PN are now complete (except if you require "-S" screw terminal option from the 5th Decision Table.)

#### Push-to-Reset (PR)

|            |                         |
|------------|-------------------------|
| <b>-XX</b> | No Button Markings Only |
|------------|-------------------------|

If you have chosen a handle from this table, your 4th Decision and your catalog PN are now complete (except if you require "-S" screw terminal option from the 5th Decision Table.)

#### 5 Fifth Decision

##### Hardware & Accessories (Notes C and D)

| Group I    |                               | Group II (Indicator Plate)                                     |                                  | Group V (Screw Terminal Options)  |   |
|------------|-------------------------------|--|----------------------------------|---|---|
| <b>-00</b> | No Outer Hardware Desired     | <b>-A</b>  | Vertical Mount (Off/On & O/I)*   | <b>-C</b>   | SAE 8-32, Upturned Lugs (Tabs) Straight Terminal    |
| <b>-10</b> | Black Knurled Nut             |  |                                  |   |   |
| <b>-11</b> | Bright Nickel Knurled Nut     |  |                                  |   |   |
| <b>-20</b> | Black Panel Dress Nut         | <b>-B</b>  | Horizontal Mount (Off/On & O/I)* | <b>-D</b>   | SAE 8-32, Bus-Type Connect (Flat) Straight Terminal |
| <b>-21</b> | Bright Nickel Panel Dress Nut |  |                                  |   |   |
| <b>-31</b> | Bright Nickel Hex Nut         |  |                                  |   |   |
| Group III  |                               | *Selection of A or B Indicator Plate required for VDE and CCC. |                                  | Please select a screw terminal option if you selected "S" in Decision 1 |   |
| <b>-L</b>  | Locking Ring                  |  |                                  |   |   |

**V** = VDE, TÜV and CCC Approved

**T** = TÜV Approved

The shaded areas denote VDE, CCC (if applicable) and CE compliant options. The V will be added to any part number formed entirely from shaded decisions. If non-shaded areas are selected, the unit will not be VDE approved, nor CE compliant, but other approvals still apply. 20 amps max rating on VDE units.

This approval requires the addition of a T at the end of the PN. The unit will not be VDE approved. If non-shaded areas are selected, the unit will not be TÜV approved, with the exception being you can select screw terminals and screw terminal options (1st & 5th decision) as these options are TÜV approved.

©2013 Sensata Technologies, Inc. All rights reserved worldwide. The following data sheet is an excerpt from our Airpax™ Power Protection Catalog, **Literature # 2455005000**, printed in the USA, **May 9th, 2013**.

**Important Notice:** Sensata Technologies reserves the right to make changes to, or to discontinue, any product or service identified in this publication without notice. Before placing orders, users should obtain the latest version of the relevant information to verify that the information being relied upon is current.

Sensata Technologies assumes no responsibility for customers' product designs or applications. Users must determine the suitability of the Sensata device described in this publication for their application, including the level of reliability required. Many factors beyond Sensata's control can affect the use and performance of a Sensata product in a particular application, including the conditions under which the product is used and the time and environmental conditions in which the product is expected to perform. As these factors are uniquely within the user's knowledge and control, it is essential that the user evaluate the Sensata product to determine whether it is fit for a particular purpose and suitable for the user's application.

Sensata Technologies products are sold subject to Sensata's Terms and Conditions of Sale which can be found at: [www.sensata.com/terms.htm](http://www.sensata.com/terms.htm)



**Sensata Technologies Inc.**  
529 Pleasant Street  
Attleboro, MA 02703, USA  
Phone: +1 508-236-3287

<http://airpax.sensata.com/>