

$V_{RSM}$	$V_{RRM}$	$(dv/dt)_{cr}$	$I_{TRMS}$ (maximum value for continuous operation)			
	$V_{DRM}$		50 A			
			$I_{TAV}$ (sin. 180; $T_{case} = 68\text{ °C}$ )			
V	V	V/ $\mu$ s	32 A			
500	400	500	–	–	SKKH 26/04 D	–
700	600	500	SKKT 26/06 D	–	SKKH 26/06 D	SKKH 27/06 D
900	800	500	SKKT 26/08 D	SKKT 27/08 D <sup>1)</sup>	SKKH 26/08 D	SKKH 27/08 D
1300	1200	1000	SKKT 26/12 E	SKKT 27/12 E <sup>1)</sup>	SKKH 26/12 E	SKKH 27/12 E
1500	1400	1000	SKKT 26/14 E	SKKT 27/14 E <sup>1)</sup>	SKKH 26/14 E	SKKH 27/14 E
1700	1600	1000	SKKT 26/16 E	SKKT 27/16 E <sup>1)</sup>	SKKH 26/16 E	SKKH 27/16 E

## SEMIPACK® 1 Thyristor / Diode Modules

**SKKT 26**                      **SKKH 26**  
**SKKT 27**                      **SKKH 27**  
**SKKT 27B**

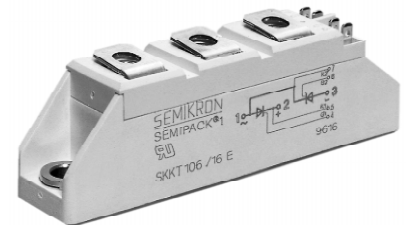

Symbol	Conditions	SKKT 26 SKKH 26	SKKT 27 SKKT 27B SKKH 27	Units
$I_{TAV}$	sin. 180; $T_{case} = 68\text{ °C}$	32		A
	$T_{case} = 85\text{ °C}$	25		A
$I_D$	B2/B6 $T_{amb} = 45\text{ °C}$ ; P 3/180	38 / 50		A
	$T_{amb} = 35\text{ °C}$ ; P 3/180 F	60 / 77		A
$I_{RMS}$	W1/W3 $T_{amb} = 45\text{ °C}$ ; P 3/180	52 / 3 x 37		A
$I_{TSM}$	$T_{vj} = 25\text{ °C}$ ; 10 ms	550		A
	$T_{vj} = 125\text{ °C}$ ; 10 ms	480		A
$i^2t$	$T_{vj} = 25\text{ °C}$ ; 8,3 ... 10 ms	1 500		A <sup>2</sup> s
	$T_{vj} = 125\text{ °C}$ ; 8,3 ... 10 ms	1 150		A <sup>2</sup> s
$t_{gd}$	$T_{vj} = 25\text{ °C}$ ; $I_G = 1\text{ A}$ $di_G/dt = 1\text{ A}/\mu\text{s}$	1		$\mu\text{s}$
$t_{gr}$	$V_D = 0,67 \cdot V_{DRM}$	1		$\mu\text{s}$
$(di/dt)_{cr}$	$T_{vj} = 125\text{ °C}$	150		A/ $\mu\text{s}$
$t_q$	$T_{vj} = 125\text{ °C}$	typ. 80		$\mu\text{s}$
$I_H$	$T_{vj} = 25\text{ °C}$ ; typ./max.	100 / 200		mA
$I_L$	$T_{vj} = 25\text{ °C}$ ; $R_G = 33\ \Omega$ ; typ./max.	250 / 400		mA
$V_T$	$T_{vj} = 25\text{ °C}$ ; $I_T = 75\text{ A}$	max. 1,8		V
$V_{T(TO)}$	$T_{vj} = 125\text{ °C}$	0,9		V
$r_T$	$T_{vj} = 125\text{ °C}$	12		m $\Omega$
$I_{DD}$ ; $I_{RD}$	$T_{vj} = 125\text{ °C}$ ; $V_{RD} = V_{RRM}$ $V_{DD} = V_{DRM}$	max. 10		mA
$V_{GT}$	$T_{vj} = 25\text{ °C}$ ; d.c.	3		V
$I_{GT}$	$T_{vj} = 25\text{ °C}$ ; d.c.	150		mA
$V_{GD}$	$T_{vj} = 125\text{ °C}$ ; d.c.	0,25		V
$I_{GD}$	$T_{vj} = 125\text{ °C}$ ; d.c.	5		mA
$R_{thjc}$	cont.	0,9 / 0,45		$^{\circ}\text{C}/\text{W}$
	sin. 180	0,95 / 0,48		$^{\circ}\text{C}/\text{W}$
	rec. 120	1,0 / 0,5		$^{\circ}\text{C}/\text{W}$
$R_{thch}$	} per thyristor / per module	0,2 / 0,1		$^{\circ}\text{C}/\text{W}$
$T_{vj}$		– 40 ... + 125		$^{\circ}\text{C}$
$T_{stg}$		– 40 ... + 125		$^{\circ}\text{C}$
$V_{isol}$	a. c. 50 Hz; r.m.s.; 1 s/1 min	3600 / 3000		V~
$M_1$	} to heatsink to terminals	5 (44 lb. in.) $\pm 15\%$ <sup>2)</sup>		Nm
$M_2$		3 (26 lb. in.) $\pm 15\%$		Nm
$a$		5 · 9,81		m/s <sup>2</sup>
$w$	approx.	95		g
Case	→ page B 1 – 95	SKKT 26: A 5 SKKH 26: A 6	SKKT 27: A 46 SKKT 27B: A 48 SKKH 27: A 47	

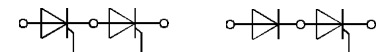

**SKKT 26**

**SKKH 26**



**SKKT 27  
SKKT 27B**

**SKKH 27**

### Features

- Heat transfer through aluminium oxide ceramic isolated metal baseplate
- Hard soldered joints for high reliability
- UL recognized, file no. E 63 532

### Typical Applications

- DC motor control (e.g. for machine tools)
- AC motor soft starters
- Temperature control (e.g. for ovens, chemical processes)
- Professional light dimming (studios, theaters)

<sup>1)</sup> Also available in SKKT 27B configuration (case A 48)

<sup>2)</sup> See the assembly instructions

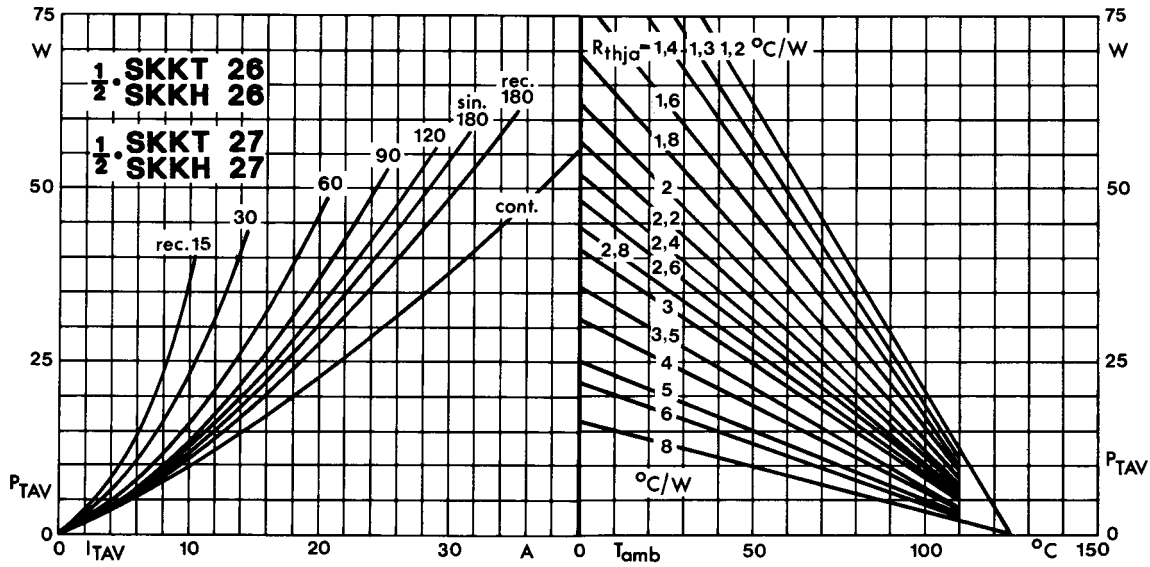

Fig. 1 Power dissipation per thyristor vs. on-state current and ambient temperature

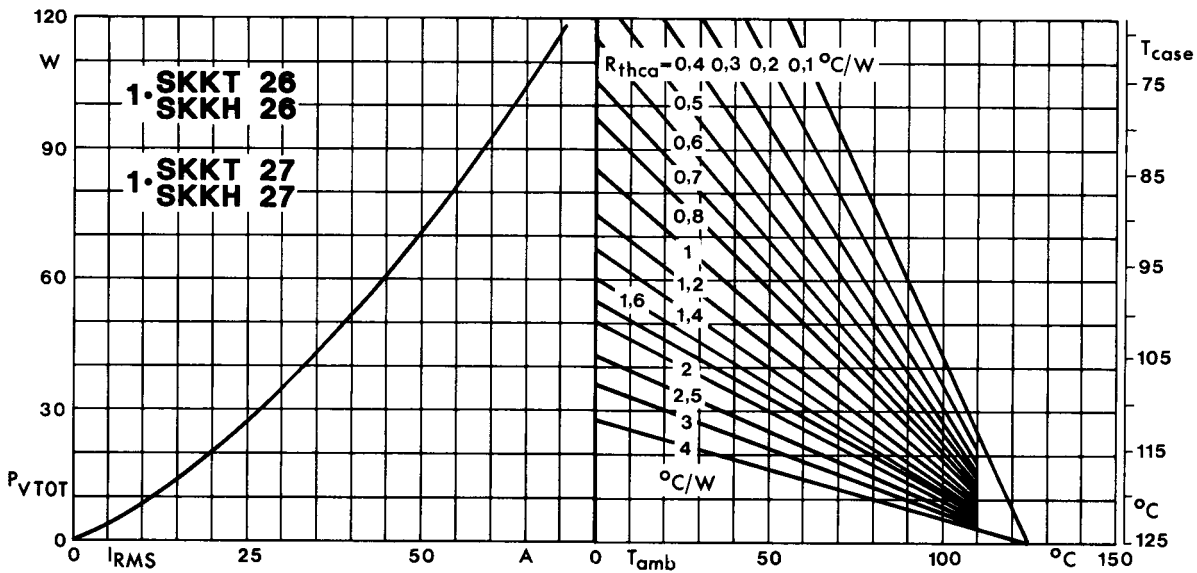

Fig. 2 Power dissipation per module vs. rms current and case temperature

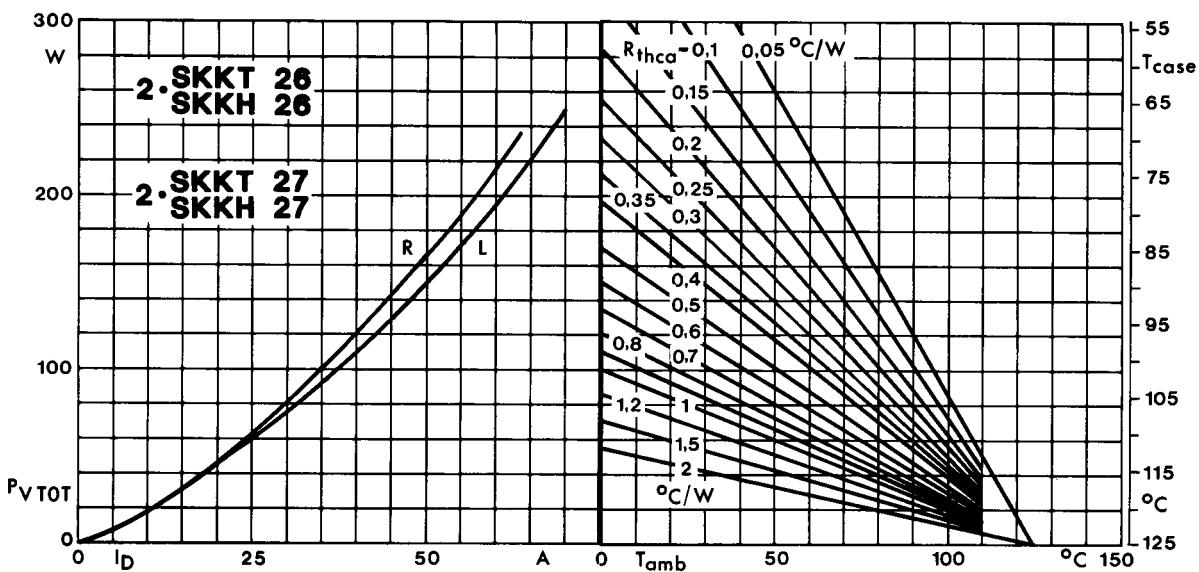

Fig. 3 Power dissipation of two modules vs. direct current and case temperature

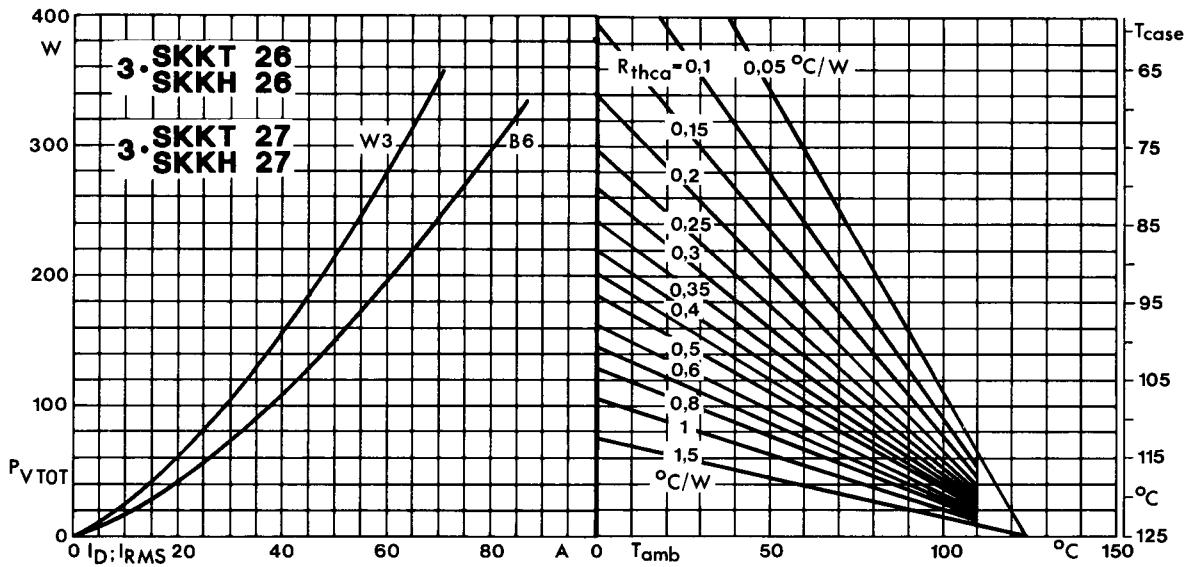

Fig. 4 Power dissipation of three modules vs. direct and rms current and case temperature

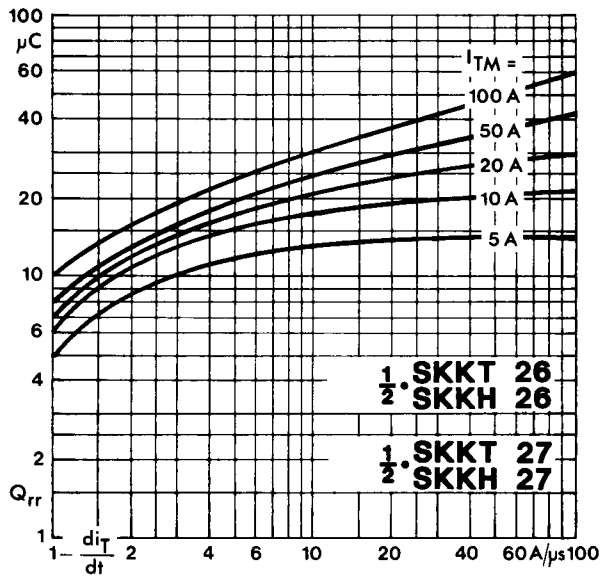

Fig. 5 Recovered charge vs. current decrease

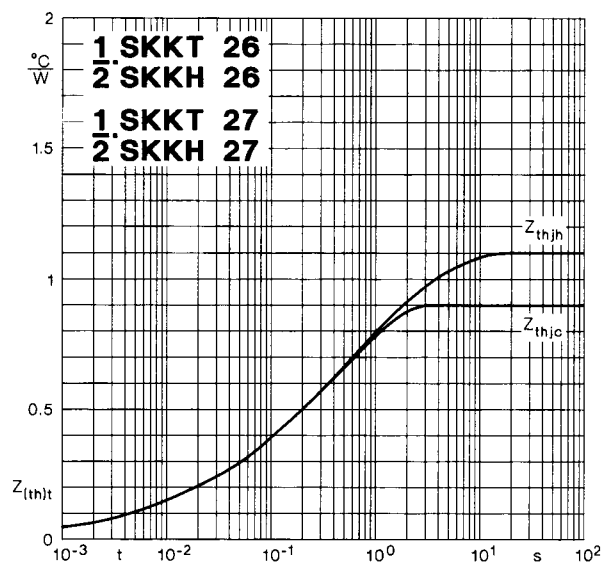

Fig. 6 Transient thermal impedance vs. time

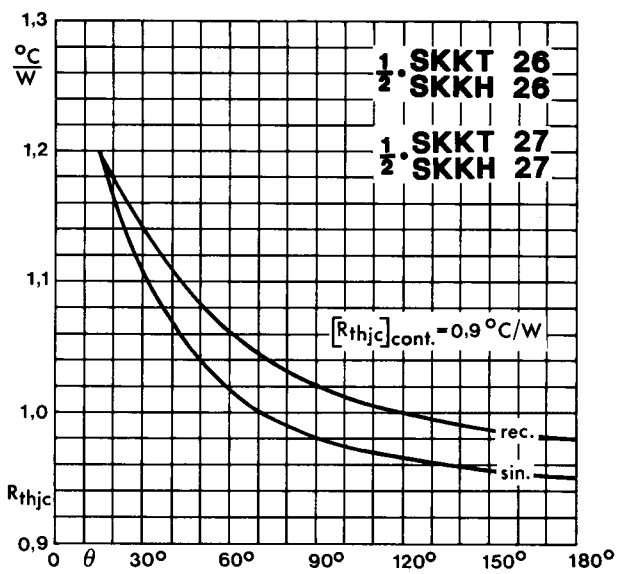

Fig. 7 Thermal resistance vs. conduction angle

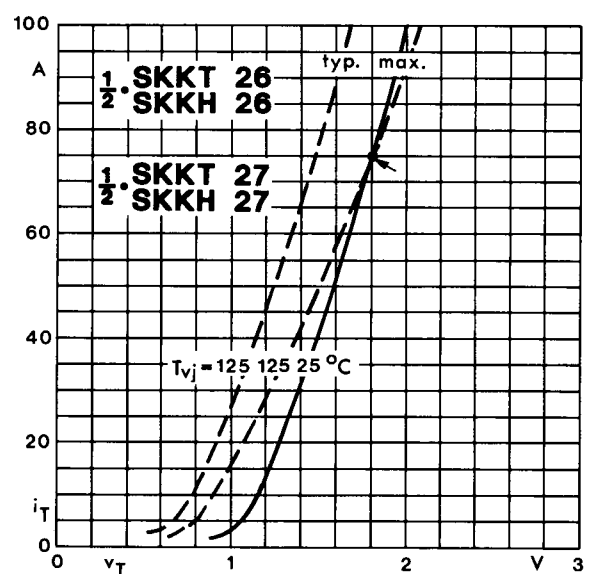

Fig. 8 On-state characteristics

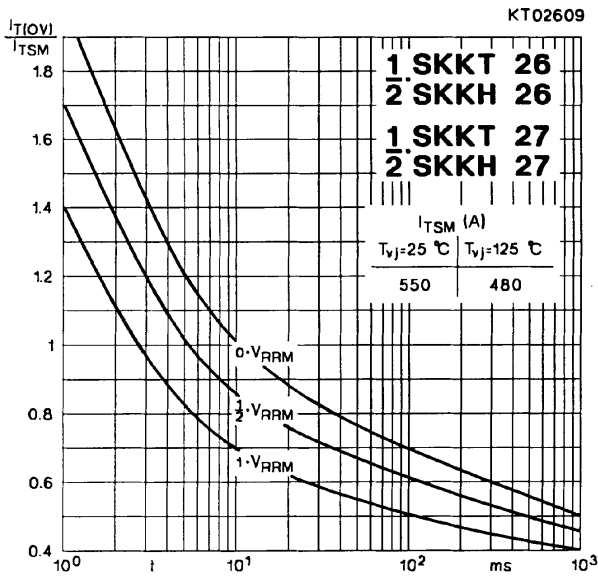

Fig. 9 Surge overload current vs. time

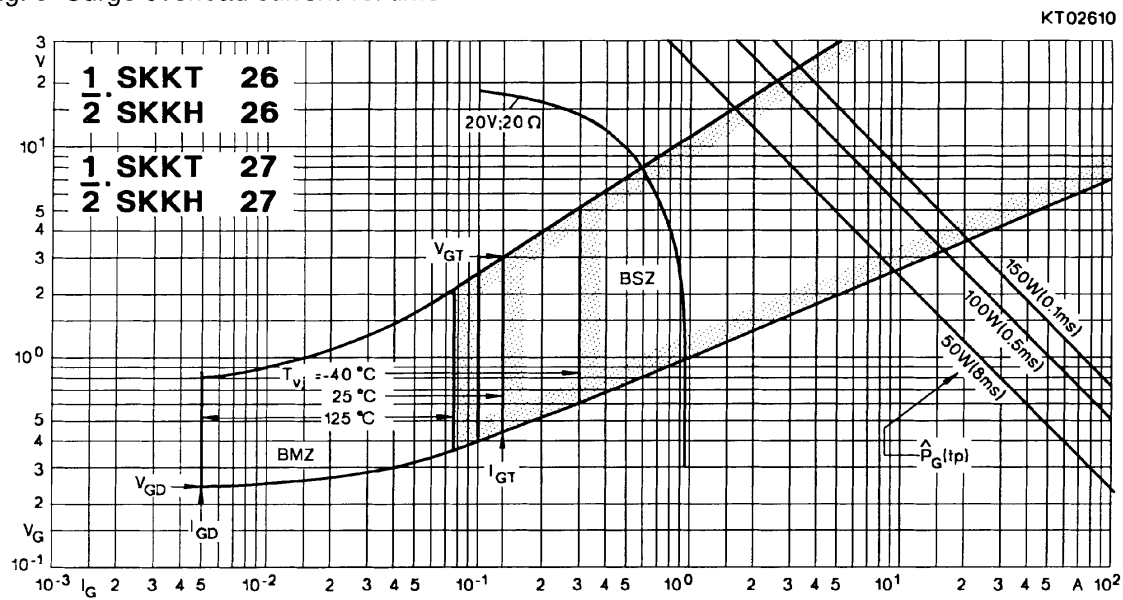
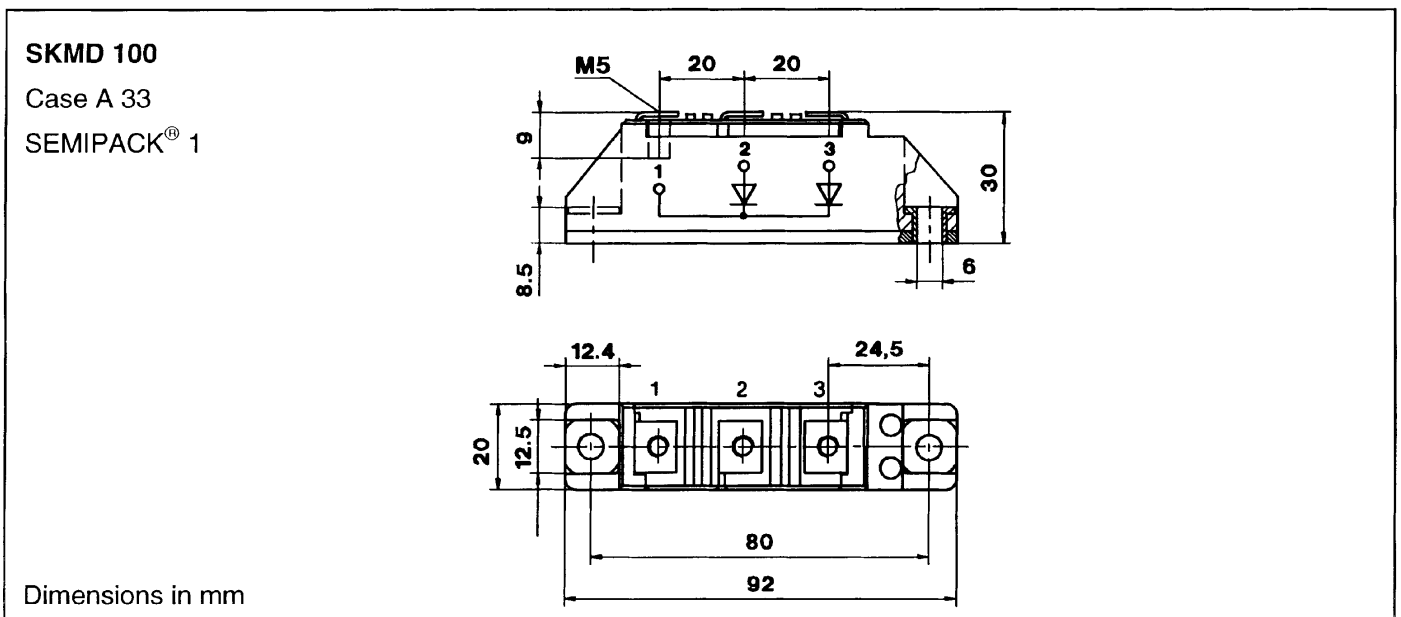

Fig. 10 Gate trigger characteristics



## SKKT 19 ... 105

Case A 5

IEC 192-2: A 77 A

JEDEC: TO-240 AA

SEMIPACK® 1

UL recognized, file no. E 63 532

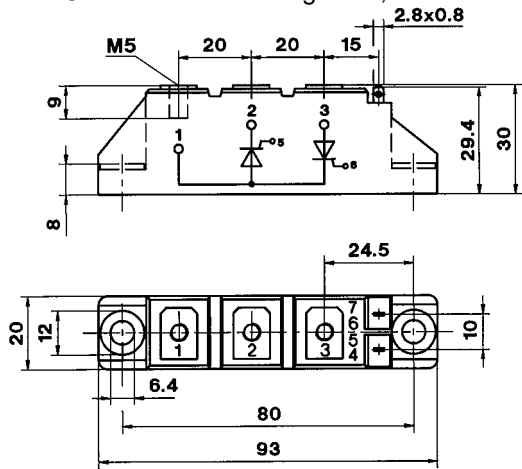

Dimensions in mm

## SKKT 20/ ... 106/

Case A 46

IEC 192-2: A 77 A

JEDEC: TO-240 AA

SEMIPACK® 1

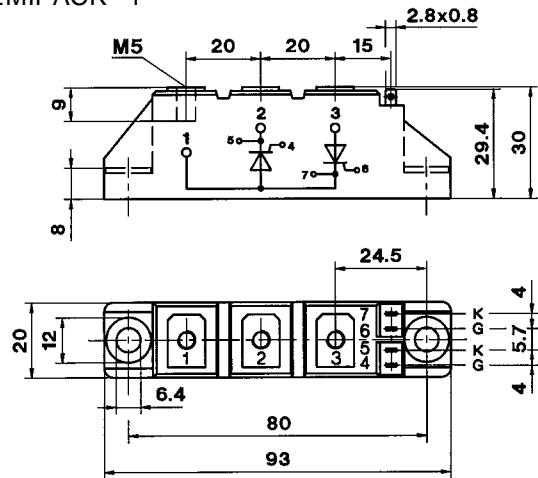

Dimensions in mm

## SKKH 26 ... 105

Case A 6

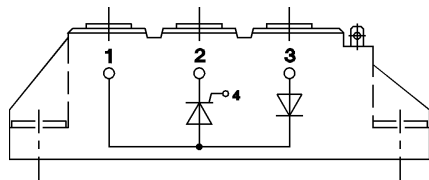

## SKKD 26 ... 100

Case A 10

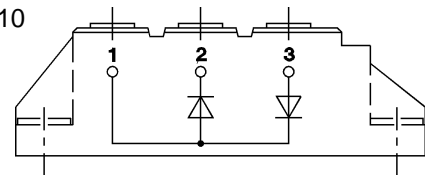

## SKNH 56 ... 91

Case A 7

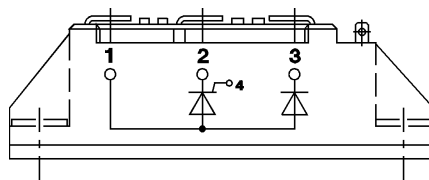

## SKKE 81

Case A 12

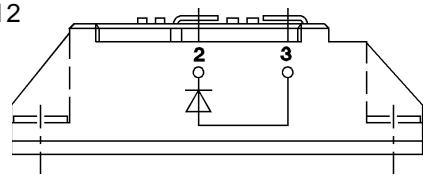

## SKKL 56 ... 105

Case A 9

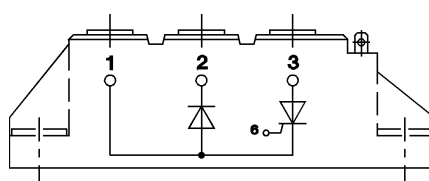

## SKKH 27 ... 106

Case A 47

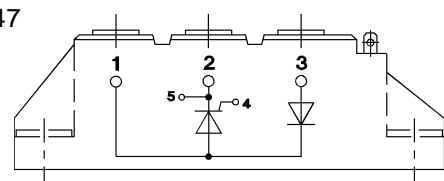

## SKND 46 ... 81

Case A 19

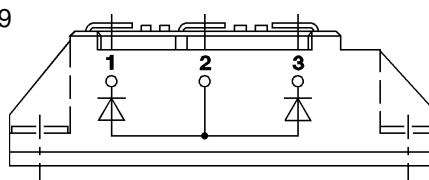

## SKKT 20 B ... 106 B

Case A 48

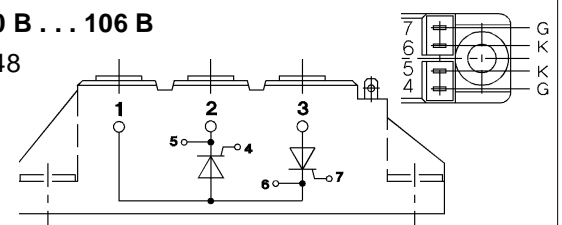

## SKMT 92

Case A 72

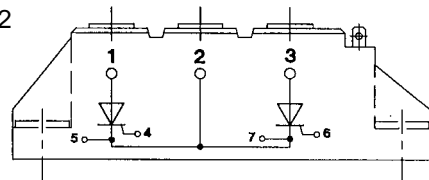

## SKKL 42 ... 106

Case A 59

